



EASA
European Aviation Safety Agency



AIR OPS

Annex I to VIII

Commission Regulation (EU) No 965/2012 on air operations

and related EASA Decisions (AMC & GM and CS-FTL.1)

Consolidated version

Revision 7¹

October 2016

¹ This is the 7th revision of the Air Ops consolidated version since its first publication on the Easy Access Rules webpage.

DISCLAIMER

This version has been prepared by the Agency in order to provide stakeholders with an updated and easy-to-read publication. It has been prepared by combining the officially published corresponding text of the regulation together with the Acceptable Means of Compliance and Guidance Material (including the amendments) adopted so far. However, this is not an official publication and the Agency accepts no liability for damage of any kind resulting from the risks inherent in the use of this document.

This document will be updated regularly to take into account further amendments.

The format of this document has been adjusted in order to make it easier to read and for reference purposes. Readers are invited and encouraged to report any perceived errors or comments relating to this publication to air_ops@easa.europa.eu.

Rule amendment status

Summary of Changes – Revision 7 (Oct. 2016) Air Ops Consolidated Version

1. EASA Decision 2016/022/R related to Reg. (EU) 2016/1199 on Helicopter Offshore Operations (HOFO)

ED Decision 2016/022/R affected **all** Annexes of Reg. (EU) No 965/2012.

The changes are related to helicopter offshore operations.

This Decision entered into force on the following day after its publication in the EASA Official Publication. It shall apply from 1 July 2018.

Date of publication in the EASA Official Publication: 07 Oct. 2016.

The affected paragraphs with the applicability date are marked accordingly in the Revision Table (IR, AMC, GM) further down.

2. Editorial changes, correcting Rev. 6 of Air Ops consolidated version

These changes are not repeated in the Revision Table (IR, AMC, GM).

#	Rule reference	Change
	Annex II – Part-ARO	
1.	AMC1 ARO.RAMP.110	Improper numbering of subparagraphs
2.	Appendix II Operations specifications – the row with PBN	The word “complex” was added in the box
	Annex IV – Part-CAT	
3.	CAT.GEN.MPA.105 (a)(10)	(iii) instead of (ii)
4.	CAT.IDE.A.205 (a)(3)	Update as amended by Reg. 2016/1199

Summary of changes – Revision 6 (Sept. 2016)

Air Ops consolidated version

Changes introduced by Commission Regulation (EU) No 2016/1199 to Reg. (EU) No 965/2012 on air operations and the related EASA Decisions:

- Operational approval of performance-based navigation;
- **Certification and oversight of data services providers and processing of the aeronautical data and information – applicable only from 01 January 2019. The related text is marked and barred;**
- **Helicopter offshore operations (HOFO) – applicable only from 01 July 2018. The affected text is marked in grey and barred;**
- Rules related to the transport of dangerous goods and rules related to upper torso restraint systems on flight crew seats and on passenger seats of certain small aeroplanes;
- Rules related to the carriage and use of supplemental oxygen supply in non-pressurised aeroplanes and helicopters engaged in non-commercial operations;
- Alleviation for twin turboprop aeroplanes with an MCTOM at or below 5 700 kg to operate under the NCO rules.

Reg. (EU) No 965/2012 and its Amendments

Reg. (EU)	Main topics	Published in O.J.	Entry into force on the X th day following the date of publication	Applicable from	Except for
2016/1199	PBN, HOFO, Part-DAT et all.	23/07/2016	On the 20 th day	25/08/2016	- HOFO: 01/07/2018 - Aeronautical data: 01/01/2019
2015/2338	Flight recordings	16/12/2015	On the 20 th day		
2015/1329	Dry-lease; FDM AOC aeroplanes	01/08/2015	On the 20 th day	01/10/2015	Opt-out: ORO.AOC.110(d): 25/08/2017
2015/640	Part 26	24/04/2015	On the 20 th day	14/05/2015	Some rules in Part-26
2015/140	Sterile flight deck procedures	30/01/2015	On the 20 th day	18/02/2016	Cover Reg. 'Art. 9b Review': 18/02/2016
379/2014	SPO, CAT A-A, S+B	24/04/2014	On the 3 rd day	01/07/2014	See official document
83/2014	FTL	31/01/2014	On the 20 th day	18/02/2016	Opt-out: ORO.FTL.205(e): 17/02/2017
71/2014	OSD	28/01/2014	On the 20 th day		See official document
800/2013	NCC/NCO	24/08/2013	The next day	25/08/2013	Opt-out: 25/08/2016
965/2012	Initial issue	25/10/2012	On the 3 rd day	28/10/2012	See official document

EASA ED Decisions (AMC/CS-FTL.1/GM) – Amendments

Note: For the official AMC and GM, always check the [Official Publication](#) webpage.

Part	Date of publication on EASA website	Incorporated Amendments
CR GM	24 Apr 2014	---
Definitions	24 Oct 2012 23 Aug 2013 20 Feb 2015 04 May 2015 02 Aug 2016 07 Oct 2016	<u>Issue 1 (initial) (2012/005/R):</u> Amd 1 (2013/017/R) Amd 2 (2015/002/R) Amd 3 (2015/012/R) Amd 4 (2016/016/R) Amd 5 (2016/022/R) – applicable from 1 July 2018
ARO	30 July 2014 28 Sept 2015 04 May 2016 02 Aug 2016 07 Oct 2016	<u>Issue 3 (2014/025/R):</u> Amd 1 (2015/022/R) Amd 2 (2016/008/R) Amd 3 (2016/014/R) Amd 4 (2016/022/R) – applicable from 1 July 2018
ORO	24 Apr 2014 30 Jan 2015 04 May 2015 28 Sept 2015 16 Dec 2015 17 Dec 2015 27 Jan 2016 04 May 2016 02 Aug 2016 07 Oct 2016	<u>Issue 2 (2014/017/R):</u> Amd 1 (2015/005/R) Amd 2 (2015/012/R) Amd 3 (2015/022/R) – applicable from 01/10/2016 Amd 4 (2015/027/R) Amd 5 (2015/030/R) Amd 6 (2016/004/R) Amd 7 (2016/008/R) Amd 8 (2016/019/R) Amd 9 (2016/022/R) – applicable from 1 July 2018
CS-FTL.1	31 Jan 2014	<u>Issue 1 (initial) (2014/002/R)</u>
CAT	24/04/2014 26/09/2014 30/01/2015 12/10/2015 17/12/2015 27/01/2016 02/08/2016 13/09/2016 07/10/2016	<u>Issue 2 (2014/015/R):</u> Amd 1 (2014/029/R) Amd 2 (2015/007/R) Amd 3 (2015/021/R) Amd 4 (2015/030/R) Amd 5 (2016/004/R) Amd 6 (2016/015/R) Amd 7 (2016/012/R) Amd 8 (2016/022/R) – applicable from 1 July 2018
SPA	24/10/2012 23/08/2013	<u>Issue 1 (initial) (2012/019/R):</u> Amd 1 (2013/020/R)

	28/09/2015 02/08/2016 07/10/2016	Amd 2 (2015/022/R) Amd 3 (2016/020/R) Amd 4 (2016/022/R) – applicable from 1 July 2018
NCC	23/08/2013 26/09/2014 30/01/2015 12/10/2015 17/12/2015 02/08/2016 13/09/2016 07/10/2016	<u>Issue 1 (initial) (2013/021/R):</u> Amd 1 (2014/030/R) Amd 2 (2015/003/R) Amd 3 (2015/021/R) Amd 4 (2015/030/R) Amd 5 (2016/017/R) Amd 6 (2016/012/R) Amd 7 (2016/022/R) – applicable from 1 July 2018
NCO	24/04/2014 26/09/2014 30/01/2015 02/08/2016 07/10/2016	<u>Issue 2 (2014/016/R):</u> Amd 1 (2014/031/R) Amd 2 (2015/004/R) Amd 3 (2016/018/R) Amd 4 (2016/022/R) – applicable from 1 July 2018
SPO	24/04/2014 26/09/2014 30/01/2015 12/10/2015 17/12/2015 02/08/2016 13/09/2016 07/10/2016	<u>Issue 1 (initial) (2014/018/R):</u> Amd 1 (2014/032/R) Amd 2 (2015/006/R) Amd 3 (2015/021/R) Amd 4 (2015/030/R) Amd 5 (2016/021/R) Amd 6 (2016/012/R) Amd 7 (2016/022/R) – applicable from 1 July 2018

Revision table (IR, AMC, GM)

Revision 7 Air Ops consolidated – Oct. 2016

Chapter	Action	Issue no./ Amdt. no.	Amended by Regulation / ED Decision
Cover Regulation			
Art. 5(2)	changed		Reg. (EU) 2016/1199: appl. from 1/7/2018
Art. 6	changed		Reg. (EU) 2016/1199
Art. 10	changed		Reg. (EU) 2016/1199
Annex I (Definitions)			
Definitions	New items		Reg. (EU) 2016/1199
GM1 Annex I	New items	1/4	ED Decision 2016/016/R
GM2 Annex I	New items	1/4	ED Decision 2016/016/R
Annex II (Part-ARO)			
AMC3 ARO.OPS.200	new	3/4	ED Decision 2016/022/R: appl. from 01/07/2018
GM1 ARO.OPS.200	new	3/4	ED Decision 2016/022/R: appl. from 01/07/2018
ARO.OPS.240	new		Reg. (EU) 2016/1199
GM1 ARO.OPS.240	new	3/3	ED Decision 2016/014/R
GM2 ARO.OPS.240	new	3/3	ED Decision 2016/014/R
Appendix II (OpSpecs)	changed		Reg. (EU) 2016/1199
Appendix V (SPA), Note 6	changed		Reg. (EU) 2016/1199: HOFO appl. from 1/7/2018
Annex III (Part-ORO)			
AMC2 ORO.GEN.160	new	2/8	ED Decision 2016/019/R
AMC1 ORO.FC.105(b)(2);c)	changed	2/9	ED Decision 2016/022/R: appl. from 01/07/2018
AMC1 ORO.FC.230	changed	2/8	ED Decision 2016/019/R
Annex IV (Part-CAT)			
GM2 CAT.GEN.MPA.195(b), paragr. (d)	changed	2/7	ED Decision 2016/012/R
AMC1 CAT.GEN.MPA.195(f)(1)	new	2/7	ED Decision 2016/012/R
GM1 CAT.GEN.MPA.195(f)(1)	new	2/7	ED Decision 2016/012/R
AMC1 CAT.GEN.MPA.195(f)(1a)	new	2/7	ED Decision 2016/012/R
GM1 CAT.GEN.MPA.195(f)(2)	new	2/7	ED Decision 2016/012/R
AMC2 CAT.OP.MPA.105	deleted	2/8	ED Decision 2016/022/R: appl. from 01/07/2018
CAT.OP.MPA.120	deleted		Reg. (EU) 2016/1199: appl. from 01/07/2018
AMC1 CAT.OP.MPA.120	deleted	2/8	ED Decision 2016/022/R: appl. from 01/07/2018

GM1 CAT.OP.MPA.120	deleted	2/8	ED Decision 2016/022/R: appl. from 01/07/2018
CAT.OP.MPA.126	new		Reg. (EU) 2016/1199
AMC1 CAT.OP.MPA.126	new	2/6	ED Decision 2016/015/R
AMC2 CAT.OP.MPA.126	new	2/6	ED Decision 2016/015/R
AMC3 CAT.OP.MPA.126	new	2/6	ED Decision 2016/015/R
AMC4 CAT.OP.MPA.126	new	2/6	ED Decision 2016/015/R
AMC5 CAT.OP.MPA.126	new	2/6	ED Decision 2016/015/R
AMC6 CAT.OP.MPA.126	new	2/6	ED Decision 2016/015/R
AMC7 CAT.OP.MPA.126	new	2/6	ED Decision 2016/015/R
GM1 CAT.OP.MPA.126	new	2/6	ED Decision 2016/015/R
CAT.OP.MPA.135 (a)(1)	changed		Reg. (EU) 2016/1199
AMC1 CAT.OP.MPA.135	new	2/6	ED Decision 2016/015/R
CAT.OP.MPA.175 (b)	changed		Reg. (EU) 2016/1199
AMC1 CAT.OP.MPA.175	new	2/6	ED Decision 2016/015/R
AMC2 CAT.OP.MPA.175	new	2/6	ED Decision 2016/015/R
CAT.OP.MPA.181	changed		Reg. (EU) 2016/1199: appl. from 01/07/2018
AMC1 CAT.OP.MPA.181(b)(1)	deleted	2/8	ED Decision 2016/022/R: appl. from 01/07/2018
GM1 CAT.OP.MPA.181	changed	2/8	ED Decision 2016/022/R: appl. from 01/07/2018
AMC1 CAT.OP.MPA.181(d)	deleted	2/8	ED Decision 2016/022/R: appl. from 01/07/2018
CAT.OP.MPA.182	new		Reg. (EU) 2016/1199
AMC1 CAT.OP.MPA.182	new	2/6	ED Decision 2016/015/R
GM1 CAT.OP.MPA.182	new	2/6	ED Decision 2016/015/R
CAT.OP.MPA.247 (b)	deleted		Reg. (EU) 2016/1199: appl. from 1/07/2018
AMC1 CAT.OP.MPA.281	changed	2/8	ED Decision 2016/022/R: appl. from 01/07/2018
CAT.OP.MPA.295	changed		Reg. (EU) 2016/1199
CAT.POL.A.240 (b)(4)	changed		Reg. (EU) 2016/1199
AMC1 CAT.POL.H.305(a)	new	2/8	ED Decision 2016/022/R: appl. from 01/07/2018
AMC1 CAT.POL.H.310(c)(2) and CAT.POL.H.325(c)(2)	new	2/8	ED Decision 2016/022/R: appl. from 01/07/2018

AMC1 CAT.IDE.A.190 → AMC1.1	changed number, title, content	2/7	ED Decision 2016/012/R
AMC1.2 CAT.IDE.A.190	new	2/7	ED Decision 2016/012/R
CAT.IDE.A.205 (a)(3); (b)	changed		Reg. (EU) 2016/1199
AMC2 CAT.IDE.A.205	changed	2/6	ED Decision 2016/015/R
GM1 CAT.IDE.A.205	new	2/6	ED Decision 2016/015/R
CAT.IDE.A.345 (f)	new		Reg. (EU) 2016/1199
GM2 CAT.IDE.A.345	new	2/6	ED Decision 2016/015/R
GM3 CAT.IDE.A.345	new	2/6	ED Decision 2016/015/R
CAT.IDE.A.355	changed		Reg. (EU) 2016/1199: appl. from 1/01/2019
AMC1 CAT.IDE.H.145	changed	2/8	ED Decision 2016/022/R: appl. from 01/07/2018
AMC2 CAT.IDE.H.145	new	2/8	ED Decision 2016/022/R: appl. from 01/07/2018
GM1 CAT.IDE.H.145	new	2/8	ED Decision 2016/022/R: appl. from 01/07/2018
GM2 CAT.IDE.H.145	new	2/8	ED Decision 2016/022/R: appl. from 01/07/2018
AMC1 CAT.IDE.H.190 → AMC1.1	changed number, title, content	2/7	ED Decision 2016/012/R
AMC1.2 CAT.IDE.H.190	new	2/7	ED Decision 2016/012/R
CAT.IDE.H.280	changed		Reg. (EU) 2016/1199: appl. from 01/07/2018
CAT.IDE.H.295	changed		Reg. (EU) 2016/1199: appl. from 1/07/2018
CAT.IDE.H.310	deleted		Reg. (EU) 2016/1199: appl. from 01/07/2018
AMC1 CAT.IDE.H.310	deleted	2/8	ED Decision 2016/022/R: appl. from 01/07/2018
AMC1 CAT.IDE.H.320(b)	changed	2/8	ED Decision 2016/022/R: appl. from 01/07/2018
GM1 CAT.IDE.H.320	new	2/8	ED Decision 2016/022/R: appl. from 01/07/2018
CAT.IDE.H.345 (e)	new		Reg. (EU) 2016/1199
GM2 CAT.IDE.H.345	new	2/6	ED Decision 2016/015/R
GM3 CAT.IDE.H.345	new	2/6	ED Decision 2016/015/R
CAT.IDE.H.355	new		Reg. (EU) 2016/1199: appl. from 1/01/2019
Annex V (Part-SPA)			

SPA.PBN.100	changed		Reg. (EU) 2016/1199
GM1 SPA.PBN.100	changed	1/3	ED Decision 2016/020/R
SPA.PBN.105	changed		Reg. (EU) 2016/1199
AMC1 SPA.PBN.105(b)	new	1/3	ED Decision 2016/020/R
AMC1 SPA.PBN.105(e)	new	1/3	ED Decision 2016/020/R
GM1 SPA.PBN.105(e)	new	1/3	ED Decision 2016/020/R
AMC1 SPA.PBN.105(d)	new	1/3	ED Decision 2016/020/R
AMC2 SPA.PBN.105(d)	new	1/3	ED Decision 2016/020/R
AMC3 SPA.PBN.105(d)	new	1/3	ED Decision 2016/020/R
AMC1 SPA.PBN.105(e)	new	1/3	ED Decision 2016/020/R
AMC1 SPA.PBN.105(f)	new	1/3	ED Decision 2016/020/R
Subpart K – HOFO operations	new		Reg. (EU) 2016/1199: appl. from 1/07/2018
AMC, GM: Subpart K – HOFO operations	new	1/4	ED Decision 2016/022/R: appl. from 01/07/2018
Annex VI (Part-NCC)			
NCC.GEN.106 (a)(4)(ix)	new		Reg. (EU) 2016/1199
AMC1 NCC.GEN.106	new	1/5	ED Decision 2016/017/R
AMC2 NCC.GEN.106	new	1/5	ED Decision 2016/017/R
GM2 NCC.GEN.145(b)	changed	1/6	ED Decision 2016/012/R
AMC1 NCC.GEN.145(f)(1)	new	1/6	ED Decision 2016/012/R
GM1 NCC.GEN.145(f)(1)	new	1/6	ED Decision 2016/012/R
AMC1 NCC.GEN.145(f)(1a)	new	1/6	ED Decision 2016/012/R
NCC.OP.116	new		Reg. (EU) 2016/1199
AMC1 NCC.OP.116	new	1/5	ED Decision 2016/017/R
AMC2 NCC.OP.116	new	1/5	ED Decision 2016/017/R
AMC3 NCC.OP.116	new	1/5	ED Decision 2016/017/R
AMC4 NCC.OP.116	new	1/5	ED Decision 2016/017/R
AMC5 NCC.OP.116	new	1/5	ED Decision 2016/017/R
AMC6 NCC.OP.116	new	1/5	ED Decision 2016/017/R

AMC7 NCC.OP.116	new	1/5	ED Decision 2016/017/R
AMC8 NCC.OP.116	new	1/5	ED Decision 2016/017/R
GM1 NCC.OP.116	new	1/5	ED Decision 2016/017/R
NCC.OP.145 (a)	changed		Reg. (EU) 2016/1199
NCC.OP.152 (b)(3)	deleted		Reg. (EU) 2016/1199: appl. from 01/07/2018
AMC1 NCC.OP.152	deleted	1/6	ED Decision 2016/022/R: appl. from 01/07/2018
NCC.OP.153	new		Reg. (EU) 2016/1199
AMC1 NCC.OP.153	new	1/5	ED Decision 2016/017/R
GM1 NCC.OP.153	new	1/5	ED Decision 2016/017/R
NCC.OP.220	changed		Reg. (EU) 2016/1199
AMC1 NCC.IDE.A.165	changed	1/6	ED Decision 2016/012/R
AMC2 NCC.IDE.A.165	new	1/6	ED Decision 2016/012/R
NCC.IDE.A.180 (b)	changed		Reg. (EU) 2016/1199
AMC2 NCC.IDE.A.180	changed	1/5	ED Decision 2016/017/R
GM1 NCC.IDE.A.180	new	1/5	ED Decision 2016/017/R
NCC.IDE.A.250 (d)	new		Reg. (EU) 2016/1199
GM1 NCC.IDE.A.250	new	1/5	ED Decision 2016/017/R
GM2 NCC.IDE.A.250	new	1/5	ED Decision 2016/017/R
NCC.IDE.A.260	changed		Reg. (EU) 2016/1199: appl. from 1/01/2019
AMC1 NCC.IDE.H.165	changed	1/6	ED Decision 2016/012/R
AMC2 NCC.IDE.H.165	new	1/6	ED Decision 2016/012/R
NCC.IDE.H.215 (b)	deleted		Reg. (EU) 2016/1199: appl. from 1/07/2018
NCC.IDE.H.226	changed		Reg. (EU) 2016/1199: appl. from 1/07/2018
NCC.IDE.H.231	deleted		Reg. (EU) 2016/1199: appl. from 01/07/2018
AMC1 NCC.IDE.H.231	deleted	1/6	ED Decision 2016/022/R: appl. from 01/07/2018
AMC1 NCC.IDE.H.235	changed	1/6	ED Decision 2016/022/R: appl. from 01/07/2018
NCC.IDE.H.250 (d)	new		Reg. (EU) 2016/1199
GM1 NCC.IDE.H.250	new	1/5	ED Decision 2016/017/R

GM2 NCC.IDE.H.250	new	1/5	ED Decision 2016/017/R
NCC.IDE.H.260	new		Reg. (EU) 2016/1199: appl. from 1/01/2019
Annex VII (Part-NCO)			
NCO.GEN.103	changed		Reg. (EU) 2016/1199
NCO.GEN.105 (a)(4)(vii)	new		Reg. (EU) 2016/1199
AMC1 NCO.GEN.105	new	2/3	ED Decision 2016/018/R
AMC2 NCO.GEN.105	new	2/3	ED Decision 2016/018/R
NCO.GEN.140 (f)	new		Reg. (EU) 2016/1199
AMC1 NCO.GEN.140(f)	new	2/3	ED Decision 2016/018/R
GM1 NCO.GEN.140(f)	new	2/3	ED Decision 2016/018/R
NCO.OP.116	new		Reg. (EU) 2016/1199
AMC1 NCO.OP.116	new	2/3	ED Decision 2016/018/R
AMC2 NCO.OP.116	new	2/3	ED Decision 2016/018/R
AMC3 NCO.OP.116	new	2/3	ED Decision 2016/018/R
AMC4 NCO.OP.116	new	2/3	ED Decision 2016/018/R
AMC5 NCO.OP.116	new	2/3	ED Decision 2016/018/R
AMC6 NCO.OP.116	new	2/3	ED Decision 2016/018/R
AMC7 NCO.OP.116	new	2/3	ED Decision 2016/018/R
AMC8 NCO.OP.116	new	2/3	ED Decision 2016/018/R
GM1 NCO.OP.116	new	2/3	ED Decision 2016/018/R
NCO.OP.135 (a)	changed		Reg. (EU) 2016/1199
NCO.OP.142	new		Reg. (EU) 2016/1199
GM1 NCO.OP.142	new	2/3	ED Decision 2016/018/R
NCO.OP.190	changed		Reg. (EU) 2016/1199
AMC1 NCO.OP.190	new	2/3	ED Decision 2016/018/R
GM1 NCO.OP.190	new	2/3	ED Decision 2016/018/R
GM2 NCO.OP.190	new	2/3	ED Decision 2016/018/R
NCO.OP.220	new		Reg. (EU) 2016/1199

NCO.IDE.A.140 (a)(4)	changed		Reg. (EU) 2016/1199
AMC2 NCO.IDE.A.140	changed	2/3	ED Decision 2016/018/R
NCO.IDE.A.155	changed		Reg. (EU) 2016/1199
AMC2 NCO.IDE.A.155	new	2/3	ED Decision 2016/018/R
NCO.IDE.A.195 (d)	new		Reg. (EU) 2016/1199
GM1 NCO.IDE.A.195	new	2/3	ED Decision 2016/018/R
GM2 NCO.IDE.A.195	new	2/3	ED Decision 2016/018/R
NCO.IDE.A.205	new		Reg. (EU) 2016/1199: appl. from 1/01/2019
NCO.IDE.H.155	changed		Reg. (EU) 2016/1199
AMC2 NCO.IDE.H.155	new	2/3	ED Decision 2016/018/R
AMC1 NCO.IDE.H.185	changed	2/4	ED Decision 2016/022/R: appl. from 1/07/2018
NCO.IDE.H.195 (d)	new		Reg. (EU) 2016/1199
GM2 NCO.IDE.H.195	new	2/3	ED Decision 2016/018/R
GM3 NCO.IDE.H.195	new	2/3	ED Decision 2016/018/R
NCO.IDE.H.205	new		Reg. (EU) 2016/1199: appl. from 1/01/2019
NCO.IDE.S.130	changed		Reg. (EU) 2016/1199
AMC1 NCO.IDE.S.130	new	2/3	ED Decision 2016/018/R
NCO.SPEC.110 (f)	changed		Reg. (EU) 2016/1199
AMC1 NCO.SPEC.110(f)	new	2/3	ED Decision 2016/018/R
GM1 NCO.SPEC.110(f)	new	2/3	ED Decision 2016/018/R
GM2 NCO.SPEC.110(f)	new	2/3	ED Decision 2016/018/R
Annex VIII (Part-SPO)			
SPO.GEN.107 (a)(4)(vii)	new		Reg. (EU) 2016/1199
AMC1 SPO.GEN.107	new	1/5	ED Decision 2016/021/R
AMC2 SPO.GEN.107	new	1/5	ED Decision 2016/021/R
GM2 SPO.GEN.145(b)	changed	1/6	ED Decision 2016/012/R
AMC1 SPO.GEN.145(f)(1)	new	1/6	ED Decision 2016/012/R
GM1 SPO.GEN.145(f)(1)	new	1/6	ED Decision 2016/012/R

AMC1 SPO.GEN.145(f)(1a)	new	1/6	ED Decision 2016/012/R
SPO.OP.116	new		Reg. (EU) 2016/1199
AMC1 SPO.OP.116	new	1/5	ED Decision 2016/021/R
AMC2 SPO.OP.116	new	1/5	ED Decision 2016/021/R
AMC3 SPO.OP.116	new	1/5	ED Decision 2016/021/R
AMC4 SPO.OP.116	new	1/5	ED Decision 2016/021/R
AMC5 SPO.OP.116	new	1/5	ED Decision 2016/021/R
AMC6 SPO.OP.116	new	1/5	ED Decision 2016/021/R
AMC7 SPO.OP.116	new	1/5	ED Decision 2016/021/R
AMC8 SPO.OP.116	new	1/5	ED Decision 2016/021/R
GM1 SPO.OP.116	new	1/5	ED Decision 2016/021/R
AMC1 SPO.OP.116	new	1/5	ED Decision 2016/021/R
AMC2 SPO.OP.116	new	1/5	ED Decision 2016/021/R
SPO.OP.140 (a)	changed		Reg. (EU) 2016/1199
SPO.OP.151 (b)(3)	deleted		Reg. (EU) 2016/1199: appl. from 1/07/2018
AMC1 SPO.OP.151	deleted	1/7	ED Decision 2016/022/R: appl. from 1/07/2018
SPO.OP.152	new		Reg. (EU) 2016/1199
AMC1 SPO.OP.152	new	1/5	ED Decision 2016/021/R
GM1 SPO.OP.152	new	1/5	ED Decision 2016/021/R
SPO.OP.205 (a)	changed		Reg. (EU) 2016/1199
AMC1 SPO.IDE.A.145	changed	1/6	ED Decision 2016/012/R
AMC2 SPO.IDE.A.145	new	1/6	ED Decision 2016/012/R
SPO.IDE.A.160 (e); (d)	changed		Reg. (EU) 2016/1199
AMC1 SPO.IDE.A.160	changed	1/5	ED Decision 2016/021/R
GM1 SPO.IDE.A.160	new	1/5	ED Decision 2016/021/R
SPO.IDE.A.160 (e)	new		Reg. (EU) 2016/1199
SPO.IDE.A.220 (d)	new		Reg. (EU) 2016/1199
GM1 SPO.IDE.A.220	new	1/5	ED Decision 2016/021/R

GM2 SPO.IDE.A.220	new	1/5	ED Decision 2016/021/R
SPO.IDE.A.230	new		Reg. (EU) 2016/1199: appl. from 1/01/2019
AMC1 SPO.IDE.H.145	changed	1/6	ED Decision 2016/012/R
AMC2 SPO.IDE.H.145	new	1/6	ED Decision 2016/012/R
SPO.IDE.H.198	changed		Reg. (EU) 2016/1199: appl. from 1/07/2018
SPO.IDE.H.201	deleted		Reg. (EU) 2016/1199: appl. from 1/07/2018
AMC1 SPO.IDE.H.201	deleted	1/7	ED Decision 2016/022/R: appl. from 1/07/2018
AMC1 SPO.IDE.H.203	changed	1/7	ED Decision 2016/022/R: appl. from 1/07/2018
SPO.IDE.H.220 (d)	new		Reg. (EU) 2016/1199
GM1 SPO.IDE.H.220	new	1/5	ED Decision 2016/021/R
GM2 SPO.IDE.H.220	new	1/5	ED Decision 2016/021/R
SPO.IDE.H.230	new		Reg. (EU) 2016/1199: appl. from 1/01/2019

COMMISSION REGULATION (EU) No 965/2012

of 5 October 2012

laying down technical requirements and administrative procedures related to air operations pursuant to Regulation (EC) No 216/2008 of the European Parliament and of the Council

[...]

Article 1

Subject matter and scope

1. This Regulation lays down detailed rules for air operations with aeroplanes, helicopters, balloons and sailplanes, including ramp inspections of aircraft of operators under the safety oversight of another State when landed at aerodromes located in the territory subject to the provisions of the Treaty.
2. This Regulation also lays down detailed rules on the conditions for issuing, maintaining, amending, limiting, suspending or revoking the certificates of operators of aircraft referred to in Article 4(1)(b) and (c) of Regulation (EC) No 216/2008 engaged in commercial air transport operation, the privileges and responsibilities of the holders of certificates as well as conditions under which operations shall be prohibited, limited or subject to certain conditions in the interest of safety.
3. This Regulation also lays down detailed rules on the conditions and procedures for the declaration by, and for the oversight of, operators engaged in commercial specialised operations and non-commercial operation of complex motor-powered aircraft, including non-commercial specialised operations of complex motor-powered aircraft.
4. This Regulation also lays down detailed rules on the conditions under which certain high risk commercial specialised operations shall be subject to authorisation in the interest of safety, and on the conditions for issuing, maintaining, amending, limiting, suspending or revoking the authorisations.
5. This Regulation shall not apply to air operations within the scope of Article 1(2)(a) of Regulation (EC) No 216/2008.
6. This Regulation shall not apply to air operations with tethered balloons and airships as well as tethered balloon flights.

Article 2

Definitions

For the purposes of this Regulation:

- (1) 'commercial air transport (CAT) operation' means an aircraft operation to transport passengers, cargo or mail for remuneration or other valuable consideration;
- (2) 'performance class B aeroplanes' means aeroplanes powered by propeller engines with a maximum operational passenger seating configuration of nine or less and a maximum take-off mass of 5 700 kg or less;
- (3) 'public interest site (PIS)' means a site used exclusively for operations in the public interest;

- (4) 'operation in performance class 1' means an operation that, in the event of failure of the critical engine, the helicopter is able to land within the rejected take-off distance available or safely continue the flight to an appropriate landing area, depending on when the failure occurs;
- (5) 'performance-based navigation (PBN)' means area navigation based on performance requirements for aircraft operating along an ATS route, on an instrument approach procedure or in a designated airspace;
- (6) 'air taxi operation' means, for the purpose of flight time and duty time limitations, a non-scheduled on demand commercial air transport operation with an aeroplane with a maximum operational passenger seating configuration ('MOPSC') of 19 or less;
- (7) 'specialised operation' means any operation other than commercial air transport where the aircraft is used for specialised activities such as agriculture, construction, photography, surveying, observation and patrol, aerial advertisement;
- (8) 'high risk commercial specialised operation' means any commercial specialised aircraft operation carried out over an area where the safety of third parties on the ground is likely to be endangered in the event of an emergency, or, as determined by the competent authority of the place where the operation is conducted, any commercial specialised aircraft operation that, due to its specific nature and the local environment in which it is conducted, poses a high risk, in particular to third parties on the ground;
- (9) 'introductory flight' means any flight against remuneration or other valuable consideration consisting of an air tour of short duration, offered by an approved training organisation or an organisation created with the aim of promoting aerial sport or leisure aviation, for the purpose of attracting new trainees or new members;
- (10) 'competition flight' means any flying activity where the aircraft is used in air races or contests, as well as where the aircraft is used to practice for air races or contests and to fly to and from racing or contest events;
- (11) 'flying display' means any flying activity deliberately performed for the purpose of providing an exhibition or entertainment at an advertised event open to the public, including where the aircraft is used to practice for a flying display and to fly to and from the advertised event.

Additional definitions are laid down in Annex I for the purposes of Annexes II to VIII.

Article 3 **Oversight capabilities**

1. Member States shall designate one or more entities as the competent authority within that Member State with the necessary powers and allocated responsibilities for the certification and oversight of persons and organisations subject to Regulation (EC) No 216/2008 and its implementing rules.
2. If a Member State designates more than one entity as competent authority:
 - (a) the areas of competence of each competent authority shall be clearly defined in terms of responsibilities and geographic limitation; and
 - (b) coordination shall be established between those entities to ensure effective oversight of all organisations and persons subject to Regulation (EC) No 216/2008 and its implementing rules within their respective remits.

3. Member States shall ensure that the competent authority(ies) has(ve) the necessary capability to ensure the oversight of all persons and organisations covered by their oversight programme, including sufficient resources to fulfil the requirements of this Regulation.
4. Member States shall ensure that competent authority personnel do not perform oversight activities when there is evidence that this could result directly or indirectly in a conflict of interest, in particular when relating to family or financial interest.
5. Personnel authorised by the competent authority to carry out certification and/or oversight tasks shall be empowered to perform at least the following tasks:
 - (a) examine the records, data, procedures and any other material relevant to the execution of the certification and/or oversight task;
 - (b) take copies of or extracts from such records, data, procedures and other material;
 - (c) ask for an oral explanation on site;
 - (d) enter relevant premises, operating sites or means of transport;
 - (e) perform audits, investigations, assessments, inspections, including ramp inspections and unannounced inspections;
 - (f) take or initiate enforcement measures as appropriate.
6. The tasks under paragraph 5 shall be carried out in compliance with the legal provisions of the relevant Member State.

Article 4
Ramp inspections

Ramp inspections of aircraft of operators under the safety oversight of another Member State or of a third country shall be carried out in accordance with Subpart RAMP of Annex II.

Article 5
Air operations

1. Operators shall only operate an aircraft for the purpose of commercial air transport (hereinafter 'CAT') operations as specified in Annexes III and IV.
 - 1a. Operators engaged in CAT operations starting and ending at the same aerodrome/operating site with Performance class B aeroplanes or non-complex helicopters shall comply with the relevant provisions of Annexes III and IV.
2. Operators shall comply with the relevant provisions of Annex V when operating:
 - (a) aeroplanes and helicopters used for:
 - (i) operations using performance-based navigation (PBN);
 - (ii) operations in accordance with minimum navigation performance specifications (MNPS);
 - (iii) operations in airspace with reduced vertical separation minima (RVSM);
 - (iv) low visibility operations (LVO);
 - (b) aeroplanes, helicopters, balloons and sailplanes used for the transport of dangerous goods (DG);

- Applicable from
1/7/2018
- (c) two-engined aeroplanes used for extended range operations (ETOPS) in commercial air transport;
 - (d) helicopters used for commercial air transport operations with the aid of night vision imaging systems (NVIS);
 - (e) helicopters used for commercial air transport hoist operations (HHO);
 - (f) helicopters used for commercial air transport emergency medical service operations (HEMS);
 - (g) helicopters used for offshore operations (HOFO).
3. Operators of complex motor-powered aeroplanes and helicopters involved in non-commercial operations shall declare their capability and means to discharge their responsibilities associated with the operation of aircraft and operate the aircraft in accordance with the provisions specified in Annex III and Annex VI. Such operators when engaged in non-commercial specialised operations shall operate the aircraft in accordance with the provisions specified in Annex III and VIII instead.
 4. Operators of other-than complex motor-powered aeroplanes and helicopters, as well as balloons and sailplanes, involved in non-commercial operations, including non-commercial specialised operations, shall operate the aircraft in accordance with the provisions specified in Annex VII.
 5. Training organisations having their principal place of business in a Member State and approved in accordance with Regulation (EU) No 1178/2011 when conducting flight training into, within or out of the Union shall operate:
 - (a) complex motor-powered aeroplanes and helicopters in accordance with the provisions specified in Annex VI;
 - (b) other aeroplanes and helicopters as well as balloons and sailplanes in accordance with the provisions specified in Annex VII.
 6. Operators shall only operate an aircraft for the purpose of commercial specialised operations as specified in Annexes III and VIII.
 7. Flights taking place immediately before, during or immediately after specialised operations and directly connected to those operations shall be operated in accordance with paragraphs 3, 4 and 6, as applicable. Except for crew members, persons other than those indispensable to the mission shall not be carried on board.

Article 6 **Derogations**

2. By way of derogation from Article 5(1), aircraft referred to in Article 4(5) of Regulation (EC) No 216/2008 shall, in the case of aeroplanes, be operated under the conditions set out in Commission Decision C(2009) 7633 of 14 October 2009 when used in CAT operations. Any change to the operation that affects the conditions set out in that Decision shall be notified to the Commission and the European Aviation Safety Agency (hereinafter 'the Agency') before the change is implemented.

A Member State, other than an addressee of Decision C(2009)7633, which intends to use the derogation provided for in that Decision shall notify its intention to the Commission and the Agency before the derogation is implemented. The Commission and the Agency shall assess to what extent the change or the intended use deviates from the conditions of Decision

C(2009)7633 or impacts on the initial safety assessment performed in the context of that Decision. If the assessment shows that the change or the intended use does not correspond to the initial safety assessment done for Decision C(2009)7633, the Member State concerned shall submit a new derogation request in accordance with Article 14(6) of Regulation (EC) No 216/2008.

3. By way of derogation from Article 5(1), flights related to the introduction or modification of aircraft types conducted by design or production organisations within the scope of their privileges shall continue to be operated under the conditions set out in Member States' national law.
4. Notwithstanding Article 5, Member States may, until 30 June 2018, continue to require a specific approval and additional requirements regarding operational procedures, equipment, crew qualification and training for CAT helicopter offshore operations in accordance with their national law. Member States shall notify the Commission and the Agency of the additional requirements being applied to such specific approvals. Those requirements shall not be less restrictive than those of Annexes III and IV.
- 4a. By way of derogation from Article 5(1) and (6), the following operations with other-than complex motor-powered aeroplanes and helicopters, balloons and sailplanes may be conducted in accordance with Annex VII:
 - (a) cost-shared flights by private individuals, on the condition that the direct cost is shared by all the occupants of the aircraft, pilot included and the number of persons sharing the direct costs is limited to six;
 - (b) competition flights or flying displays, on the condition that the remuneration or any valuable consideration given for such flights is limited to recovery of direct costs and a proportionate contribution to annual costs, as well as prizes of no more than a value specified by the competent authority;
 - (c) introductory flights, parachute dropping, sailplane towing or aerobatic flights performed either by a training organisation having its principal place of business in a Member State and approved in accordance with Regulation (EU) No 1178/2011, or by an organisation created with the aim of promoting aerial sport or leisure aviation, on the condition that the aircraft is operated by the organisation on the basis of ownership or dry lease, that the flight does not generate profits distributed outside of the organisation, and that whenever non-members of the organisation are involved, such flights represent only a marginal activity of the organisation.
5. By way of derogation from CAT.POL.A.300(a) of Annex IV, single-engined aeroplanes, when used in CAT operations, shall be operated at night or in instrument meteorological conditions (IMC) under the conditions set out in the existing exemptions granted by Member States in accordance with Article 8(2) of Regulation (EEC) No 3922/91.

Any change to the operation of these aeroplanes that affects the conditions set out in those exemptions shall be notified to the Commission and the Agency before the change is implemented. The Commission and the Agency shall assess the proposed change in accordance with Article 14(5) of Regulation (EC) No 216/2008.

6. Existing helicopter operations to/from a public interest site (PIS) may be conducted in derogation to CAT.POL.H.225 of Annex IV whenever the size of the PIS, the obstacle environment or the helicopter does not permit compliance with the requirements for operation in performance class 1. Such operations shall be conducted under conditions determined by Member States. Member States shall notify the Commission and the Agency of the conditions being applied.

7. [deleted with Reg. EU 2016/1199]
8. By way of derogation from the first sentence of Article 5(3), operators of complex motor-powered aeroplanes with a maximum certificated take-off mass (MCTOM) at or below 5 700 kg, equipped with turboprop engines, involved in non-commercial operations, shall operate those aircraft only in accordance with Annex VII.
9. By way of derogation from Article 5(5)(a), training organisations shall, when conducting flight training on complex motor-powered aeroplanes with a maximum certificated take-off mass (MCTOM) at or below 5 700 kg, equipped with turboprop engines, operate those aircraft in accordance with Annex VII.

GM1 Article 6.4a Derogations

OTHER-THAN-COMPLEX MOTOR-POWERED AIRCRAFT

The term 'other-than-complex motor-powered aircraft' is used synonymously with the terms 'other-than-complex motor-powered aircraft' and 'other than complex motor-powered aircraft'. Whenever one of these terms is used, it includes also non-motor-powered aircraft such as sailplanes and balloons.

GM2 Article 6.4a(a);(b) Derogations

DIRECT COST

'Direct cost' means the cost directly incurred in relation to a flight, e.g. fuel, airfield charges, rental fee for an aircraft. There is no element of profit.

GM3 Article 6.4a(a);(b) Derogations

ANNUAL COST

'Annual cost' means the cost of keeping, maintaining and operating the aircraft over a period of one calendar year. There is no element of profit.

GM1 Article 6.4a(c) Derogations

ORGANISATION CREATED WITH THE AIM OF PROMOTING AERIAL SPORT OR LEISURE AVIATION

An 'organisation created with the aim of promoting aerial sport or leisure aviation' means a non-profit organisation, established under applicable national law for the sole purpose of gathering persons sharing the same interest in general aviation to fly for pleasure or to conduct parachute jumping. The organisation should have aircraft available.

GM2 Article 6.4a(c) Derogations

MARGINAL ACTIVITY

The term 'marginal activity' should be understood as representing a very minor part of the overall activity of an organisation, mainly for the purpose of promoting itself or attracting new students or members. An organisation intending to offer such flights as regular business activity is not considered to meet the condition of marginal activity. Also, flights organised with the sole intent to generate income for the organisation, are not considered to be a marginal activity.

Article 7
Air operator certificates

1. Air operator certificates (AOCs) issued by a Member State to CAT operators of aeroplanes before this Regulation applies in accordance with Regulation (EEC) No 3922/91 shall be deemed to have been issued in accordance with this Regulation.

However, no later than 28 October 2014:

- (a) operators shall adapt their management system, training programmes, procedures and manuals to be compliant with Annexes III, IV and V, as relevant;
 - (b) the AOC shall be replaced by certificates issued in accordance with Annex II to this Regulation.
2. AOCs issued by a Member State to CAT operators of helicopters before this Regulation applies shall be converted into AOCs compliant with this Regulation in accordance with a conversion report established by the Member State that issued the AOC, in consultation with the Agency.

The conversion report shall describe:

- (a) the national requirements on the basis of which the AOCs were issued;
- (b) the scope of privileges that were given to the operators;
- (c) the differences between the national requirements on the basis of which the AOCs were issued and the requirements of Annexes III, IV and V, together with an indication of how and when the operators will be required to ensure full compliance with those Annexes.

The conversion report shall include copies of all documents necessary to demonstrate the elements set out in points (a) to (c), including copies of the relevant national requirements and procedures.

Article 8
Flight time limitations

1. CAT operations with aeroplanes shall be subject to Subpart FTL of Annex III.
2. By way of derogation from paragraph 1, air taxi, emergency medical service and single pilot CAT operations by aeroplanes shall be subject to Article 8(4) of Regulation (EEC) No 3922/91 and Subpart Q of Annex III to Regulation (EEC) No 3922/91 and to related national exemptions based on safety risk assessments carried out by the competent authorities.
3. CAT operations with helicopters, CAT operations with balloons and CAT operations with sailplanes shall comply with national requirements.
4. Non-commercial operations, including non-commercial specialised operations, with complex motor-powered aeroplanes and helicopters, as well as commercial specialised operations with aeroplanes, helicopters, balloons and sailplanes shall continue to be conducted in accordance with applicable national flight time limitation legislation until the related implementing rules are adopted and apply.

Article 9

Minimum equipment lists

Minimum equipment lists ('MEL') approved by the State of Operator or Registry before the application of this Regulation, are deemed to be approved in accordance with this Regulation and may continue to be used by the operator.

After the entry into force of this Regulation any change to the MEL referred to in the first subparagraph for which a Master Minimum Equipment List ('MMEL') is established as part of the operational suitability data in accordance with Commission Regulation (EU) No 748/2012² shall be made in compliance with point ORO.MLR.105 of Section 2 of Annex III to this Regulation at the earliest opportunity and not later than 18 December 2017 or two years after the operational suitability data was approved, whichever is the latest.

Any change to an MEL referred to in the first subparagraph, for which an MMEL has not been established as part of the operational suitability data, shall continue to be made in accordance with the MMEL accepted by the State of Operator or Registry as applicable.

Article 9a

Flight and cabin crew training

Operators shall ensure that flight crew and cabin crew members who are already in operation and have completed training in accordance with Subparts FC and CC of Annex III which did not include the mandatory elements established in the relevant operational suitability data, undertake training covering those mandatory elements not later than 18 December 2017 or two years after the approval of the operational suitability data, whichever is the latest.

Article 9b

Review

The Agency shall conduct a continuous review of the effectiveness of the provisions concerning flight and duty time limitations and rest requirements contained in Annexes II and III. No later than 18 February 2019 the Agency shall produce a first report on the results of this review.

That review shall involve scientific expertise and shall be based on operational data gathered, with the assistance of Member States, on a long-term basis after the date of application of this Regulation.

The review shall assess the impact of at least the following on the alertness of aircrew:

- (a) duties of more than 13 hours at the most favourable times of the day;
- (b) duties of more than 10 hours at less favourable times of the day;
- (c) duties of more than 11 hours for crew members in an unknown state of acclimatisation;
- (d) duties including a high level of sectors (more than 6);
- (e) on-call duties such as standby or reserve followed by flight duties; and
- (f) disruptive schedules.

² OJ L 224, 21.8.2012, p. 1.

Article 10

Entry into force

1. This Regulation shall enter into force on the third day following that of its publication in the *Official Journal of the European Union*.

It shall apply from 28 October 2012, subject to paragraphs 2, 3, 4, 5 and 6 below.

2. Annexes II and VII shall apply to non-commercial operations with balloons and sailplanes from 25 August 2013, except for Member States that have decided not to apply all or part of them in accordance with the provisions in force at the time of that decision and to the extent they have decided to do so. Those Member States shall apply Annexes II and VII from 8 April 2018 to non-commercial operations with balloons and from 8 April 2019 to non-commercial operations with sailplanes or from the dates indicated in their decision, as the case may be.
3. Annexes II, III, VII and VIII shall apply to specialised operations with balloons and sailplanes from 1 July 2014, except for Member States that have decided not to apply all or part of them in accordance with the provisions in force at the time of that decision, and to the extent they have decided to do so. Those Member States shall apply Annexes II, III, VII and VIII from 8 April 2018 to specialised operations with balloons and from 8 April 2019 to specialised operations with sailplanes or from the dates indicated in their decision, as the case may be.
4. Annexes II, III, VII and VIII shall apply to specialised operations with aeroplanes and helicopters from 1 July 2014, except for Member States that have decided not to apply all or part of them in accordance with the provisions in force at the time of that decision and to the extent they have decided to do so. Those Member States shall apply Annexes II, III, VII and VIII to specialised operations with aeroplanes and helicopters from 21 April 2017 or from the dates indicated in their decision, as the case may be.
5. Annexes II, III and IV shall apply to:
 - (a) CAT operations starting and ending at the same aerodrome or operating site with Performance class B aeroplanes or non-complex helicopters from 1 July 2014, except for Member States that have decided not to apply all or part of them in accordance with the provisions in force at the time of that decision and to the extent they have decided to do so. Those Member States shall apply Annexes II, III and IV to CAT operations starting and ending at the same aerodrome or operating site with Performance class B aeroplanes or non-complex helicopters from 21 April 2017 or from the dates indicated in their decision, as the case may be;
 - (b) CAT operations with balloons and sailplanes from 1 July 2014, except for Member States that have decided not to apply all or part of them in accordance with the provisions in force at the time of that decision and to the extent they have decided to do so. Those Member States shall apply Annexes II, III and IV from 8 April 2018 to CAT operations with balloons, and from 8 April 2019 to CAT operations with sailplanes or from the dates indicated in their decision, as the case may be.
6. The following shall apply during the periods provided for in paragraphs 2, 3, 4 and 5 of this Article, as applicable:
 - (a) The competent authorities shall, from the date of entry into force of the requirements of this Regulation, take gradual and effective measures to comply with those requirements, including by adapting their organisation and management system, training of personnel, procedures and manuals and oversight programme;

- (b) Operators shall adapt their management system, training programmes, procedures and manuals to be compliant with the requirements of this Regulation, as relevant, no later than the date of application of those requirements;
- (c) Until the date of application of the relevant requirements of this Regulation, Member States shall continue to issue, renew or modify certificates, authorisations and approvals in accordance with the rules in force before the entry into force of those requirements or, in the case of CAT operations starting and ending at the same aerodrome or operating site with Performance class B aeroplanes or non-complex helicopters, in accordance with:
 - Annex III to Regulation (EEC) No 3922/91 and related national exemptions in accordance with Article 8(2) of Regulation (EEC) No 3922/91, for aeroplanes; and
 - national requirements, for helicopters.
- (d) Certificates, authorisations and approvals issued by Member States before the date of application of the relevant requirements of this Regulation shall be deemed to have been issued in accordance with those requirements. However, they shall be replaced by certificates, authorisations and approvals, as appropriate, issued in accordance with this Regulation no later than six months from the date of application of the relevant requirements of this Regulation;
- (e) Operators subject to a declaration obligation in accordance with this Regulation shall submit their declarations no later than the date of application of the relevant requirements of this Regulation.

This Regulation shall enter into force on the twentieth day following that of its publication in the Official Journal of the European Union.

It [*N.B. Reg. (EU) No 2016/1199*] shall apply from 25 August 2016.³

This Regulation shall be binding in its entirety and directly applicable in all Member States.

³ Please consult [Regulation \(EU\) No 2016/1199](#) for reference to the legal document. Article 3 states:

“However,

(a) point 1 of Article 1 and points 1(a), 1(b), 1(c), 1(d), 2(c), 3(a), 3(e), 3(g), 3(m), 3(n), 3(o), 4(c), 5(d), 5(j), 5(k), 5(l), 7(d), 7(k) and 7(l) of the Annex shall apply from 1 July 2018;

(b) points 3(l), 3(q), 5(i), 5(n), 6(k), 6(n), 7(j) and 7(n) of the Annex shall apply from 1 January 2019.”

ANNEX I

Definitions for terms used in Annexes II to VIII

For the purpose of this Regulation, the following definitions shall apply:

- (1) ‘accelerate-stop distance available (ASDA)’ means the length of the take-off run available plus the length of stopway, if such stopway is declared available by the State of the aerodrome and is capable of bearing the mass of the aeroplane under the prevailing operating conditions;
- (2) ‘acceptable means of compliance (AMC)’ means non-binding standards adopted by the Agency to illustrate means to establish compliance with Regulation (EC) No 216/2008 and its Implementing Rules;
- (3) ‘acceptance checklist’ means a document used to assist in carrying out a check on the external appearance of packages of dangerous goods and their associated documents to determine that all appropriate requirements have been met with;
- (4) ‘adequate aerodrome’ means an aerodrome on which the aircraft can be operated, taking account of the applicable performance requirements and runway characteristics;
- (5) For the purpose of passenger classification:
 - (a) ‘adult’ means a person of an age of 12 years and above;
 - (b) ‘child/children’ means persons who are of an age of two years and above but who are less than 12 years of age;
 - (c) ‘infant’ means a person under the age of two years;
- (6) ‘aeroplane’ means an engine-driven fixed-wing aircraft heavier than air that is supported in flight by the dynamic reaction of the air against its wings;
- (7) ‘aided night vision imaging system (NVIS) flight’ means, in the case of NVIS operations, that portion of a visual flight rules (VFR) flight performed at night when a crew member is using night vision goggles (NVG);
- (8) ‘aircraft’ means a machine that can derive support in the atmosphere from the reactions of the air other than the reactions of the air against the earth’s surface;
- (8a) ‘aircraft tracking’ means a ground based process that maintains and updates, at standardised intervals, a record of the four dimensional position of individual aircraft in flight;
- (8b) ‘aircraft tracking system’ means a system that relies on aircraft tracking in order to identify abnormal flight behaviour and provide alert;
- (9) ‘alternative means of compliance’ means those means that propose an alternative to an existing acceptable means of compliance or those that propose new means to establish compliance with Regulation (EC) No 216/2008 and its Implementing Rules for which no associated AMC have been adopted by the Agency;
- (10) ‘anti-icing’, in the case of ground procedures, means a procedure that provides protection against the formation of frost or ice and accumulation of snow on treated surfaces of the aircraft for a limited period of time (hold-over time);
- (11) ‘approach procedure with vertical guidance (APV) operation’ means an instrument approach which utilises lateral and vertical guidance, but does not meet the requirements established for

- precision approach and landing operations, with a decision height (DH) not lower than 250 ft and a runway visual range (RVR) of not less than 600 m;
- (11a) ‘balloon empty mass’ means the mass determined by weighing the balloon with all the installed equipment as specified in the AFM;
- (12) ‘cabin crew member’ means an appropriately qualified crew member, other than a flight crew or technical crew member, who is assigned by an operator to perform duties related to the safety of passengers and flight during operations;
- (13) ‘category I (CAT I) approach operation’ means a precision instrument approach and landing using an instrument landing system (ILS), microwave landing system (MLS), GLS (ground-based augmented global navigation satellite system (GNSS/GBAS) landing system), precision approach radar (PAR) or GNSS using a satellite-based augmentation system (SBAS) with a decision height (DH) not lower than 200 ft and with a runway visual range (RVR) not less than 550 m for aeroplanes and 500 m for helicopters;
- (14) ‘category II (CAT II) operation’ means a precision instrument approach and landing operation using ILS or MLS with:
- (a) DH below 200 ft but not lower than 100 ft; and
 - (b) RVR of not less than 300 m;
- (15) ‘category IIIA (CAT IIIA) operation’ means a precision instrument approach and landing operation using ILS or MLS with:
- (a) DH lower than 100 ft; and
 - (b) RVR not less than 200 m;
- (16) ‘category IIIB (CAT IIIB) operation’ means a precision instrument approach and landing operation using ILS or MLS with:
- (a) DH lower than 100 ft, or no DH; and
 - (b) RVR lower than 200 m but not less than 75 m;
- (17) ‘category A with respect to helicopters’ means a multi-engined helicopter designed with engine and system isolation features specified in the applicable airworthiness codes and capable of operations using take-off and landing data scheduled under a critical engine failure concept that assures adequate designated surface area and adequate performance capability for continued safe flight or safe rejected take-off in the event of engine failure;
- (18) ‘category B with respect to helicopters’ means a single-engined or multi-engined helicopter that does not meet category A standards. Category B helicopters have no guaranteed capability to continue safe flight in the event of an engine failure, and unscheduled landing is assumed;
- (19) ‘certification specifications’ (CS) means technical standards adopted by the Agency indicating means to show compliance with Regulation (EC) No 216/2008 and its Implementing Rules and which can be used by an organisation for the purpose of certification;
- (20) ‘circling’ means the visual phase of an instrument approach to bring an aircraft into position for landing on a runway/FATO that is not suitably located for a straight-in approach;
- (21) ‘clearway’ means a defined rectangular area on the ground or water under the control of the appropriate authority, selected or prepared as a suitable area over which an aeroplane may make a portion of its initial climb to a specified height;
- (22) ‘cloud base’ means the height of the base of the lowest observed or forecast cloud element in the vicinity of an aerodrome or operating site or within a specified area of operations, normally

- measured above aerodrome elevation or, in the case of offshore operations, above mean sea level;
- (23) ‘code share’ means an arrangement under which an operator places its designator code on a flight operated by another operator, and sells and issues tickets for that flight;
- (24) ‘congested area’ means in relation to a city, town or settlement, any area which is substantially used for residential, commercial or recreational purposes;
- (25) ‘contaminated runway’ means a runway of which more than 25 % of the runway surface area within the required length and width being used is covered by the following:
- (a) surface water more than 3 mm (0,125 in) deep, or by slush, or loose snow, equivalent to more than 3 mm (0,125 in) of water;
 - (b) snow which has been compressed into a solid mass which resists further compression and will hold together or break into lumps if picked up (compacted snow); or
 - (c) ice, including wet ice;
- (26) ‘contingency fuel’ means the fuel required to compensate for unforeseen factors that could have an influence on the fuel consumption to the destination aerodrome;
- (27) ‘continuous descent final approach (CDFA)’ means a technique, consistent with stabilised approach procedures, for flying the final-approach segment of a non-precision instrument approach procedure as a continuous descent, without level-off, from an altitude/height at or above the final approach fix altitude/height to a point approximately 15 m (50 ft) above the landing runway threshold or the point where the flare manoeuvre shall begin for the type of aircraft flown;
- (28) ‘converted meteorological visibility (CMV)’ means a value, equivalent to an RVR, which is derived from the reported meteorological visibility;
- (29) ‘crew member’ means a person assigned by an operator to perform duties on board an aircraft;
- (30) ‘critical phases of flight’ in the case of aeroplanes means the take-off run, the take-off flight path, the final approach, the missed approach, the landing, including the landing roll, and any other phases of flight as determined by the pilot-in-command or commander;
- (31) ‘critical phases of flight’ in the case of helicopters means taxiing, hovering, take-off, final approach, missed approach, the landing and any other phases of flight as determined by the pilot-in-command or commander;
- (32) ‘damp runway’ means a runway where the surface is not dry, but when the moisture on it does not give it a shiny appearance;
- (33) ‘dangerous goods (DG)’ means articles or substances which are capable of posing a risk to health, safety, property or the environment and which are shown in the list of dangerous goods in the technical instructions or which are classified according to those instructions;
- (34) ‘dangerous goods accident’ means an occurrence associated with and related to the transport of dangerous goods by air which results in fatal or serious injury to a person or major property damage;
- (35) ‘dangerous goods incident’ means:
- (a) an occurrence other than a dangerous goods accident associated with and related to the transport of dangerous goods by air, not necessarily occurring on board an aircraft, which results in injury to a person, property damage, fire, breakage, spillage, leakage of fluid or radiation or other evidence that the integrity of the packaging has not been maintained;

- (b) any occurrence relating to the transport of dangerous goods which seriously jeopardises an aircraft or its occupants;
- (36) ‘de-icing’, in the case of ground procedures, means a procedure by which frost, ice, snow or slush is removed from an aircraft in order to provide uncontaminated surfaces;
- (37) ‘defined point after take-off (DPATO)’ means the point, within the take-off and initial climb phase, before which the helicopter’s ability to continue the flight safely, with the critical engine inoperative, is not assured and a forced landing may be required;
- (38) ‘defined point before landing (DPBL)’ means the point within the approach and landing phase, after which the helicopter’s ability to continue the flight safely, with the critical engine inoperative, is not assured and a forced landing may be required;
- (39) ‘distance DR’ means the horizontal distance that the helicopter has travelled from the end of the take-off distance available;
- (40) ‘dry lease agreement’ means an agreement between undertakings pursuant to which the aircraft is operated under the air operator certificate (AOC) of the lessee or, in the case of commercial operations other than CAT, under the responsibility of the lessee;
- (41) ‘dry operating mass’ means the total mass of the aircraft ready for a specific type of operation, excluding usable fuel and traffic load;
- (42) ‘dry runway’ means a runway which is neither wet nor contaminated, and includes those paved runways which have been specially prepared with grooves or porous pavement and maintained to retain ‘effectively dry’ braking action even when moisture is present;
- (43) ‘ELA1 aircraft’ means the following manned European Light Aircraft:
 - (a) an aeroplane with a Maximum Take-off Mass (MTOM) of 1 200 kg or less that is not classified as complex motor-powered aircraft;
 - (b) a sailplane or powered sailplane of 1 200 kg MTOM or less;
 - (c) a balloon with a maximum design lifting gas or hot air volume of not more than 3400 m³ for hot air balloons, 1 050 m³ for gas balloons, 300 m³ for tethered gas balloons;
- (44) ‘ELA2 aircraft’ means the following manned European Light Aircraft:
 - (a) an aeroplane with a Maximum Take-off Mass (MTOM) of 2 000 kg or less that is not classified as complex motor-powered aircraft;
 - (b) a sailplane or powered sailplane of 2 000 kg MTOM or less;
 - (c) a balloon;
 - (d) a Very Light Rotorcraft with a MTOM not exceeding 600 kg which is of a simple design, designed to carry not more than two occupants, not powered by turbine and/or rocket engines; restricted to VFR day operations;
- (45) ‘elevated final approach and take-off area (elevated FATO)’ means a FATO that is at least 3 m above the surrounding surface;
- (46) ‘en-route alternate (ERA) aerodrome’ means an adequate aerodrome along the route, which may be required at the planning stage;
- (47) ‘enhanced vision system (EVS)’ means a system to display electronic real-time images of the external scene achieved through the use of imaging sensors;
- (48) ‘final approach and take-off area (FATO)’ means a defined area for helicopter operations, over which the final phase of the approach manoeuvre to hover or land is completed, and from which

- the take-off manoeuvre is commenced. In the case of helicopters operating in performance class 1, the defined area includes the rejected take-off area available;
- (49) ‘flight data monitoring (FDM)’ means the proactive and non-punitive use of digital flight data from routine operations to improve aviation safety;
- (50) ‘flight simulation training device (FSTD)’ means a training device which is:
- (a) in the case of aeroplanes, a full flight simulator (FFS), a flight training device (FTD), a flight and navigation procedures trainer (FNPT), or a basic instrument training device (BITD);
 - (b) in the case of helicopters, a full flight simulator (FFS), a flight training device (FTD) or a flight and navigation procedures trainer (FNPT);
- (51) ‘fuel ERA aerodrome’ means an ERA aerodrome selected for the purpose of reducing contingency fuel;
- (52) ‘GBAS landing system (GLS)’ means an approach landing system using ground based augmented global navigation satellite system (GNSS/GBAS) information to provide guidance to the aircraft based on its lateral and vertical GNSS position. It uses geometric altitude reference for its final approach slope;
- (53) ‘ground emergency service personnel’ means any ground emergency service personnel (such as policemen, firemen, etc.) involved with helicopter emergency medical services (HEMSs) and whose tasks are to any extent pertinent to helicopter operations;
- (54) ‘grounding’ means the formal prohibition of an aircraft to take-off and the taking of such steps as are necessary to detain it;
- (55) ‘head-up display (HUD)’ means a display system which presents flight information to the pilot’s forward external field of view and which does not significantly restrict the external view;
- (56) ‘head-up guidance landing system (HUDLS)’ means the total airborne system that provides head-up guidance to the pilot during the approach and landing and/or missed approach procedure. It includes all sensors, computers, power supplies, indications and controls;
- (57) ‘helicopter’ means a heavier-than-air aircraft supported in flight chiefly by the reactions of the air on one or more power-driven rotors on substantially vertical axes;
- (58) ‘helicopter hoist operation (HHO) crew member’ means a technical crew member who performs assigned duties relating to the operation of a hoist;
- (59) ‘helideck’ means a FATO located on a floating or fixed offshore structure;
- (60) ‘HEMS crew member’ means a technical crew member who is assigned to a HEMS flight for the purpose of attending to any person in need of medical assistance carried in the helicopter and assisting the pilot during the mission;
- (61) ‘HEMS flight’ means a flight by a helicopter operating under a HEMS approval, the purpose of which is to facilitate emergency medical assistance, where immediate and rapid transportation is essential, by carrying:
- (a) medical personnel;
 - (b) medical supplies (equipment, blood, organs, drugs); or
 - (c) ill or injured persons and other persons directly involved;
- (62) ‘HEMS operating base’ means an aerodrome at which the HEMS crew members and the HEMS helicopter may be on stand-by for HEMS operations;
- (63) ‘HEMS operating site’ means a site selected by the commander during a HEMS flight for helicopter hoist operations, landing and take-off;

- (64) ‘HHO flight’ means a flight by a helicopter operating under an HHO approval, the purpose of which is to facilitate the transfer of persons and/or cargo by means of a helicopter hoist;
- (65) ‘HHO offshore’ means a flight by a helicopter operating under an HHO approval, the purpose of which is to facilitate the transfer of persons and/or cargo by means of a helicopter hoist from or to a vessel or structure in a sea area or to the sea itself;
- (66) ‘HHO passenger’ means a person who is to be transferred by means of a helicopter hoist;
- (67) ‘HHO site’ means a specified area at which a helicopter performs a hoist transfer;
- (68) ‘hold-over time (HoT)’ means the estimated time the anti-icing fluid will prevent the formation of ice and frost and the accumulation of snow on the protected (treated) surfaces of an aeroplane;
- (69) ‘hostile environment’ means:
- (a) an area in which:
 - (i) a safe forced landing cannot be accomplished because the surface is inadequate; or
 - (ii) the helicopter occupants cannot be adequately protected from the elements; or
 - (iii) search and rescue response/capability are not provided consistent with anticipated exposure; or
 - (iv) there is an unacceptable risk of endangering persons or property on the ground;
 - (b) in any case, the following areas:
 - (i) for overwater operations, the open sea area north of 45 N and south of 45 S, unless any part is designated as non-hostile by the responsible authority of the State in which the operations take place; and
 - (ii) those parts of a congested area without adequate safe forced landing areas;
- (70) ‘landing decision point (LDP)’ means the point used in determining landing performance from which, an engine failure having been recognised at this point, the landing may be safely continued or a balked landing initiated;
- (71) ‘landing distance available (LDA)’ means the length of the runway which is declared available by the State of the aerodrome and suitable for the ground run of an aeroplane landing;
- (72) ‘landplane’ means a fixed wing aircraft which is designed for taking off and landing on land and includes amphibians operated as landplanes;
- (73) ‘local helicopter operation’ means a commercial air transport operation of helicopters with a maximum certified take-off mass (MCTOM) over 3 175 kg and a maximum operational passenger seating configuration (MOPSC) of nine or less, by day, over routes navigated by reference to visual landmarks, conducted within a local and defined geographical area specified in the operations manual;
- (74) ‘low visibility procedures (LVP)’ means procedures applied at an aerodrome for the purpose of ensuring safe operations during lower than standard category I, other than standard category II, category II and III approaches and low visibility take-offs;
- (75) ‘low visibility take-off (LVTO)’ means a take-off with an RVR lower than 400 m but not less than 75 m;
- (76) ‘lower than standard category I (LTS CAT I) operation’ means a category I instrument approach and landing operation using category I DH, with an RVR lower than would normally be associated with the applicable DH but not lower than 400 m;

- (77) ‘maximum operational passenger seating configuration (MOPSC)’ means the maximum passenger seating capacity of an individual aircraft, excluding crew seats, established for operational purposes and specified in the operations manual. Taking as a baseline the maximum passenger seating configuration established during the certification process conducted for the type certificate (TC), supplemental type certificate (STC) or change to the TC or STC as relevant to the individual aircraft, the MOPSC may establish an equal or lower number of seats, depending on the operational constraints;
- (78) ‘medical passenger’ means a medical person carried in a helicopter during a HEMS flight, including but not limited to doctors, nurses and paramedics;
- (79) ‘night’ means the period between the end of evening civil twilight and the beginning of morning civil twilight or such other period between sunset and sunrise as may be prescribed by the appropriate authority, as defined by the Member State;
- (80) ‘night vision goggles (NVG)’ means a head-mounted, binocular, light intensification appliance that enhances the ability to maintain visual surface references at night;
- (81) ‘night vision imaging system (NVIS)’ means the integration of all elements required to successfully and safely use NVGs while operating a helicopter. The system includes as a minimum: NVGs, NVIS lighting, helicopter components, training and continuing airworthiness;
- (82) ‘non-hostile environment’ means an environment in which:
- (a) a safe forced landing can be accomplished;
 - (b) the helicopter occupants can be protected from the elements; and
 - (c) search and rescue response/capability is provided consistent with the anticipated exposure.
- In any case, those parts of a congested area with adequate safe forced landing areas shall be considered non-hostile;
- (83) ‘non-precision approach (NPA) operation’ means an instrument approach with a minimum descent height (MDH), or DH when flying a CDF/A technique, not lower than 250 ft and an RVR/CMV of not less than 750 m for aeroplanes and 600 m for helicopters;
- (84) ‘NVIS crew member’ means a technical crew member assigned to an NVIS flight;
- (85) ‘NVIS flight’ means a flight under night visual meteorological conditions (VMC) with the flight crew using NVGs in a helicopter operating under an NVIS approval;
- (86) ‘offshore operation’ means a helicopter operation that has a substantial proportion of any flight conducted over open sea areas to or from an offshore location;
- (86a) ‘offshore location’ means a facility intended to be used for helicopter operations on a fixed or floating offshore structure or a vessel;
- (86b) ‘open sea area’ means the area of water to seaward of the coastline;
- (87) ‘operating site’ means a site, other than an aerodrome, selected by the operator or pilot-in-command or commander for landing, take-off and/or external load operations;
- (88) ‘operation in performance class 1’ means an operation that, in the event of failure of the critical engine, the helicopter is able to land within the rejected take-off distance available or safely continue the flight to an appropriate landing area, depending on when the failure occurs;
- (89) ‘operation in performance class 2’ means an operation that, in the event of failure of the critical engine, performance is available to enable the helicopter to safely continue the flight, except when the failure occurs early during the take-off manoeuvre or late in the landing manoeuvre, in which cases a forced landing may be required;

- (90) ‘operation in performance class 3’ means an operation that, in the event of an engine failure at any time during the flight, a forced landing may be required in a multi-engined helicopter and will be required in a single-engined helicopter;
- (91) ‘operational control’ means the responsibility for the initiation, continuation, termination or diversion of a flight in the interest of safety;
- (92) ‘other than standard category II (OTS CAT II) operation’ means a precision instrument approach and landing operation using ILS or MLS where some or all of the elements of the precision approach category II light system are not available, and with:
- (a) DH below 200 ft but not lower than 100 ft; and
 - (b) RVR of not less than 350 m;
- (93) ‘performance class A aeroplanes’ means multi-engined aeroplanes powered by turbo-propeller engines with an MOPSC of more than nine or a maximum take-off mass exceeding 5 700 kg, and all multi-engined turbo-jet powered aeroplanes;
- (94) ‘performance class B aeroplanes’ means aeroplanes powered by propeller engines with an MOPSC of nine or less and a maximum take-off mass of 5 700 kg or less;
- (95) ‘performance class C aeroplanes’ means aeroplanes powered by reciprocating engines with an MOPSC of more than nine or a maximum take-off mass exceeding 5 700 kg;
- (96) ‘pilot-in-command’ means the pilot designated as being in command and charged with the safe conduct of the flight. For the purpose of commercial air transport operations, the ‘pilot-in-command’ shall be termed the ‘commander’;
- (97) ‘principal place of business’ means the head office or registered office of the organisation within which the principal financial functions and operational control of the activities referred to in this Regulation are exercised;
- (98) ‘prioritisation of ramp inspections’ means the dedication of an appropriate portion of the total number of ramp inspections conducted by or on behalf of a competent authority on an annual basis as provided in Part-ARO;
- (99) ‘public interest site (PIS)’ means a site used exclusively for operations in the public interest;
- (100) ‘ramp inspection’ means the inspection of aircraft, of flight and cabin crew qualifications and of flight documentation in order to verify the compliance with the applicable requirements;
- (101) ‘rectification interval’ means a limitation on the duration of operations with inoperative equipment;
- (102) ‘rejected take-off distance available (RTODAH)’ means the length of the final approach and take-off area declared available and suitable for helicopters operated in performance class 1 to complete a rejected take-off;
- (103) ‘rejected take-off distance required (RTODRH)’ means the horizontal distance required from the start of the take-off to the point where the helicopter comes to a full stop following an engine failure and rejection of the take-off at the take-off decision point;
- (103a) ‘required navigation performance (RNP) specification’ means a navigation specification for PBN operations which includes a requirement for on-board navigation performance monitoring and alerting;
- (104) ‘runway visual range (RVR)’ means the range over which the pilot of an aircraft on the centre line of a runway can see the runway surface markings or the lights delineating the runway or identifying its centre line;

- (105) ‘safe forced landing’ means an unavoidable landing or ditching with a reasonable expectancy of no injuries to persons in the aircraft or on the surface;
- (106) ‘seaplane’ means a fixed wing aircraft which is designed for taking off and landing on water and includes amphibians operated as seaplanes;
- (107) ‘separate runways’ means runways at the same aerodrome that are separate landing surfaces. These runways may overlay or cross in such a way that if one of the runways is blocked, it will not prevent the planned type of operations on the other runway. Each runway shall have a separate approach procedure based on a separate navigation aid;
- (108) ‘special VFR flight’ means a VFR flight cleared by air traffic control to operate within a control zone in meteorological conditions below VMC;
- (109) ‘stabilised approach (SAp)’ means an approach that is flown in a controlled and appropriate manner in terms of configuration, energy and control of the flight path from a pre-determined point or altitude/height down to a point 50 ft above the threshold or the point where the flare manoeuvre is initiated if higher;
- (109a) ‘sterile flight crew compartment’ means any period of time when the flight crew members are not disturbed or distracted, except for matters critical to the safe operation of the aircraft or the safety of the occupants;
- (110) ‘take-off alternate aerodrome’ means an alternate aerodrome at which an aircraft can land should this become necessary shortly after take-off and if it is not possible to use the aerodrome of departure;
- (111) ‘take-off decision point (TDP)’ means the point used in determining take-off performance from which, an engine failure having been recognised at this point, either a rejected take-off may be made or a take-off safely continued;
- (112) ‘take-off distance available (TODA)’ in the case of aeroplanes means the length of the take-off run available plus the length of the clearway, if provided;
- (113) ‘take-off distance available (TODAH)’ in the case of helicopters means the length of the final approach and take-off area plus, if provided, the length of helicopter clearway declared available and suitable for helicopters to complete the take-off;
- (114) ‘take-off distance required (TODRH)’ in the case of helicopters means the horizontal distance required from the start of the take-off to the point at which take-off safety speed (V_{Toss}), a selected height and a positive climb gradient are achieved, following failure of the critical engine being recognised at the TDP, the remaining engines operating within approved operating limits;
- (115) ‘take-off flight path’ means the vertical and horizontal path, with the critical engine inoperative, from a specified point in the take-off for aeroplanes to 1 500 ft above the surface and for helicopters to 1 000 ft above the surface;
- (116) ‘take-off mass’ means the mass including everything and everyone carried at the commencement of the take-off for helicopters and take-off run for aeroplanes;
- (117) ‘take-off run available (TORA)’ means the length of runway that is declared available by the State of the aerodrome and suitable for the ground run of an aeroplane taking off;
- (117a) ‘task specialist’ means a person assigned by the operator or a third party, or acting as an undertaking, who performs tasks on the ground directly associated with a specialised task or performs specialised tasks on board or from the aircraft;
- (118) ‘technical crew member’ means a crew member in commercial air transport HEMS, HHO or NVIS operations other than a flight or cabin crew member, assigned by the operator to duties in the

- aircraft or on the ground for the purpose of assisting the pilot during HEMS, HHO or NVIS operations, which may require the operation of specialised on-board equipment;
- (119) ‘technical instructions (TI)’ means the latest effective edition of the ‘Technical instructions for the safe transport of dangerous goods by air’, including the supplement and any addenda, approved and published by the International Civil Aviation Organisation;
- (120) ‘traffic load’ means the total mass of passengers, baggage, cargo and carry-on specialist equipment and, except for balloons, including any ballast;
- (121) ‘unaided NVIS flight’ means, in the case of NVIS operations, that portion of a VFR flight performed at night when a crew member is not using NVG;
- (122) ‘undertaking’ means any natural or legal person, whether profit-making or not, or any official body whether having its own personality or not;
- (123) ‘ V_1 ’ means the maximum speed in the take-off at which the pilot must take the first action to stop the aeroplane within the accelerate-stop distance. V_1 also means the minimum speed in the take-off, following a failure of the critical engine at V_{EF} , at which the pilot can continue the take-off and achieve the required height above the take-off surface within the take-off distance;
- (124) ‘ V_{EF} ’ means the speed at which the critical engine is assumed to fail during take-off;
- (125) ‘visual approach’ means an approach when either part or all of an instrument approach procedure is not completed and the approach is executed with visual reference to the terrain;
- (126) ‘weather-permissible aerodrome’ means an adequate aerodrome where, for the anticipated time of use, weather reports, or forecasts, or any combination thereof, indicate that the weather conditions will be at or above the required aerodrome operating minima, and the runway surface condition reports indicate that a safe landing will be possible;
- (127) ‘wet lease agreement’ means an agreement:
- in the case of CAT operations, between air carriers pursuant to which the aircraft is operated under the AOC of the lessor; or
 - in the case of commercial operations other than CAT, between operators pursuant to which the aircraft is operated under the responsibility of the lessor;
- (128) ‘wet runway’ means a runway of which the surface is covered with water, or equivalent, less than specified by the ‘contaminated runway’ definition or when there is sufficient moisture on the runway surface to cause it to appear reflective, but without significant areas of standing water.

GM1 Annex I Definitions

DEFINITIONS FOR TERMS USED IN ACCEPTABLE MEANS OF COMPLIANCE AND GUIDANCE MATERIAL

For the purpose of Acceptable Means of Compliance and Guidance Material to Regulation (EU) No 965/2012, the following definitions should apply:

- (a) ‘Accuracy’ means, in the context of PBN operations, the degree of conformance between the estimated, measured or desired position and/or the velocity of a platform at a given time, and its true position or velocity. Navigation performance accuracy is usually presented as a statistical measure of system error and is specified as predictable, repeatable and relative.
- (b) ‘Aircraft-based augmentation system (ABAS)’ means a system that augments and/or integrates the information obtained from the other GNSS elements with information available on board the aircraft. The most common form of ABAS is receiver autonomous integrity monitoring (RAIM).

- (c) 'Area navigation (RNAV)' means a method of navigation which permits aircraft operation on any desired flight path within the coverage of station-referenced navigation aids or within the limits of the capability of self-contained aids, or a combination of these.
- (d) 'Availability' means, in the context of PBN operations, an indication of the ability of the system to provide usable service within the specified coverage area and is defined as the portion of time during which the system is to be used for navigation during which reliable navigation information is presented to the crew, autopilot or other system managing the flight of the aircraft.
- (e) 'Committal point' means the point in the approach at which the pilot flying decides that, in the event of an engine failure being recognised, the safest option is to continue to the elevated final approach and take-off area (elevated FATO).
- (f) 'Continuity of function' means, in the context of PBN operations, the capability of the total system, comprising all elements necessary to maintain aircraft position within the defined airspace, to perform its function without non-scheduled interruptions during the intended operation.
- (g) 'Emergency locator transmitter' is a generic term describing equipment that broadcasts distinctive signals on designated frequencies and, depending on application, may be activated by impact or may be manually activated.
- (h) 'Exposure time' means the actual period during which the performance of the helicopter with the critical engine inoperative in still air does not guarantee a safe forced landing or the safe continuation of the flight.
- (i) 'Fail-operational flight control system' means a flight control system with which, in the event of a failure below alert height, the approach, flare and landing can be completed automatically. In the event of a failure, the automatic landing system will operate as a fail-passive system.
- (j) 'Fail-operational hybrid landing system' means a system that consists of a primary fail-passive automatic landing system and a secondary independent guidance system enabling the pilot to complete a landing manually after failure of the primary system.
- (k) 'Fail-passive flight control system': a flight control system is fail-passive if, in the event of a failure, there is no significant out-of-trim condition or deviation of flight path or attitude but the landing is not completed automatically. For a fail-passive automatic flight control system the pilot assumes control of the aeroplane after a failure.
- (l) 'Flight control system' in the context of low visibility operations means a system that includes an automatic landing system and/or a hybrid landing system.
- (m) 'HEMS dispatch centre' means a place where, if established, the coordination or control of the helicopter emergency medical service (HEMS) flight takes place. It may be located in a HEMS operating base.
- (n) 'Hybrid head-up display landing system (hybrid HUDLS)' means a system that consists of a primary fail-passive automatic landing system and a secondary independent HUD/HUDLS enabling the pilot to complete a landing manually after failure of the primary system.
- (o) 'Integrity' means, in the context of PBN operations, the ability of a system to provide timely warnings to users when the system should not be used for navigation.
- (p) 'Landing distance available (LDAH)' means the length of the final approach and take-off area plus any additional area declared available by the State of the aerodrome and suitable for helicopters to complete the landing manoeuvre from a defined height.
- (q) 'Landing distance required (LDRH)', in the case of helicopters, means the horizontal distance required to land and come to a full stop from a point 15 m (50 ft) above the landing surface.

- (r) ‘Lateral navigation’ means a method of navigation which permits aircraft operation on a horizontal plane using radio navigation signals, other positioning sources, external flight path references, or a combination of these.
- (s) ‘Maximum structural landing mass’ means the maximum permissible total aeroplane mass upon landing under normal circumstances.
- (t) ‘Maximum zero fuel mass’ means the maximum permissible mass of an aeroplane with no usable fuel. The mass of the fuel contained in particular tanks should be included in the zero fuel mass when it is explicitly mentioned in the aircraft flight manual.
- (u) ‘Overpack’, for the purpose of transporting dangerous goods, means an enclosure used by a single shipper to contain one or more packages and to form one handling unit for convenience of handling and stowage.
- (v) ‘Package’, for the purpose of transporting dangerous goods, means the complete product of the packing operation consisting of the packaging and its contents prepared for transport.
- (w) ‘Packaging’, for the purpose of transporting dangerous goods, means receptacles and any other components or materials necessary for the receptacle to perform its containment function.
- (x) ‘Personal locator beacon (PLB)’ is an emergency beacon other than an ELT that broadcasts distinctive signals on designated frequencies, is standalone, portable and is manually activated by the survivors.
- (y) ‘Receiver autonomous integrity monitoring (RAIM)’ means a technique whereby a GNSS receiver/processor determines the integrity of the GNSS navigation signals using only GNSS signals or GNSS signals augmented with altitude. This determination is achieved by a consistency check among redundant pseudo-range measurements. At least one satellite in addition to those required for navigation has to be in view for the receiver to perform the RAIM function.
- (z) ‘Rotation point (RP)’ means the point at which a cyclic input is made to initiate a nose-down attitude change during the take-off flight path. It is the last point in the take-off path from which, in the event of an engine failure being recognised, a forced landing on the aerodrome can be achieved.
- (aa) ‘Space-based augmentation system (SBAS)’ means a wide coverage augmentation system that augments and/or integrates the information obtained from the other GNSS elements with information from a satellite-based transmitter. The most common form of SBAS in Europe is the European Geostationary Navigation Overlay Service (EGNOS).
- (ab) ‘Touch down and lift-off area (TLOF)’ means a load-bearing area on which a helicopter may touch down or lift off.
- (ac) ‘Vertical navigation’ means a method of navigation which permits aircraft operation on a vertical flight profile using altimetry sources, external flight path references, or a combination of these.

GM2 Annex I Definitions

ABBREVIATIONS AND ACRONYMS

The following abbreviations and acronyms are used in the Annexes to this Regulation:

A	aeroplane
a/c	aircraft
AAC	aeronautical administrative communications
AAIM	aircraft autonomous integrity monitoring

AAL	above aerodrome level
ABAS	aircraft-based augmentation system
AC	advisory circular
AC	alternating current
ACAS	airborne collision avoidance system
ADF	automatic direction finder
ADG	air driven generator
ADS	automatic dependent surveillance
ADS-B	automatic dependent surveillance - broadcast
ADS-C	automatic dependent surveillance - contract
AEA	Association of European Airlines
AEO	all-engines-operative
AFFF	aqueous film forming foams
AFM	aircraft flight manual
AFN	aircraft flight notification
AFN	ATS facilities notification
AGL	above ground level
AHRS	attitude heading reference system
AIS	aeronautical information service
ALARP	as low as reasonably practicable
ALSF	approach lighting system with sequenced flashing lights
AMC	Acceptable Means of Compliance
AML	aircraft maintenance licence
AMSL	above mean sea level
ANP	actual navigation performance
AOC	aeronautical operational control
AOC	air operator certificate
APCH	approach
APU	auxiliary power unit
APV	approach procedure with vertical guidance
AR	authorisation required
ARA	airborne radar approach
ARA	Authority Requirements for Aircrew
A-RNP	advanced required navigation performance
ARO	Authority Requirements for Air Operations
ARP	Aerospace Recommended Practices
ASC	Air Safety Committee

ASDA	accelerate-stop distance available
ASE	altimeter system error
ATA	Air Transport Association
ATC	air traffic control
ATIS	automatic terminal information service
ATN	air traffic navigation
ATPL	airline transport pilot licence
ATQP	alternative training and qualification programme
ATS	air traffic services
ATSC	air traffic service communication
AVGAS	aviation gasoline
AVTAG	aviation turbine gasoline (wide-cut fuel)
AWO	all weather operations
BALS	basic approach lighting system
Baro-VNAV	barometric VNAV
BCAR	British civil airworthiness requirements
BITD	basic instrument training device
CAP	controller access parameters
CAT	commercial air transport
CAT I / II / III	category I / II / III
CBT	computer-based training
CC	cabin crew
CDFA	continuous descent final approach
CDL	configuration deviation list
CFIT	controlled flight into terrain
CG	centre of gravity
CM	context management
CMV	converted meteorological visibility
CofA	certificate of airworthiness
COP	code of practice
CoR	certificate of registration
COSPAS-SARSAT	cosmicheskaya sistyema poiska avariynich sudov - search and rescue satellite-aided tracking
CP	committal point
CPA	closest point of approach
CPDLC	controller pilot data link communication
CPL	commercial pilot licence

C-PED	controlled portable electronic device
CRE	class rating examiner
CRI	class rating instructor
CRM	crew resource management
CS	Certification Specifications
CVR	cockpit voice recorder
DA	decision altitude
DA/H	decision altitude/height
DAP	downlinked aircraft parameters
D-ATIS	digital automatic terminal information service
DC	direct current
DCL	departure clearance
D-FIS	data link flight information service
DG	dangerous goods
DH	decision height
DI	daily inspection
DIFF	deck integrated fire fighting system
DLR	data link recorder
DME	distance measuring equipment
D-METAR	data link - meteorological aerodrome report
D-OTIS	data link - operational terminal information service
DPATO	defined point after take-off
DPBL	defined point before landing
DR	decision range
DSTRK	desired track
EC	European Community
ECAC	European Civil Aviation Conference
EFB	electronic flight bag
EFIS	electronic flight instrument system
EGNOS	European geostationary navigation overlay service
EGT	exhaust gas temperature
ELT	emergency locator transmitter
ELT(AD)	emergency locator transmitter (automatically deployable)
ELT(AF)	emergency locator transmitter (automatic fixed)
ELT(AP)	emergency locator transmitter (automatic portable)
ELT(S)	survival emergency locator transmitter
EPE	estimated position of error

EPR	engine pressure ratio
EPU	estimated position of uncertainty
ERA	en-route alternate (aerodrome)
ERP	emergency response plan
ETOPS	extended range operations with two-engined aeroplanes
EU	European Union
EUROCAE	European Organisation for Civil Aviation Equipment
EVS	enhanced vision system
FAA	Federal Aviation Administration
FAF	final approach fix
FALS	full approach lighting system
FANS	future air navigation systems
FAP	final approach point
FAR	Federal Aviation Regulation
FATO	final approach and take-off
FC	flight crew
FCL	flight crew licensing
FCOM	flight crew operating manual
FDM	flight data monitoring
FDO	flying display operation
FDR	flight data recorder
FFS	full flight simulator
FGS	flight control/guidance system
FI	flight instructor
FLIPCY	flight plan consistency
FLTA	forward-looking terrain avoidance
FMECA	failure mode, effects and criticality analysis
FMS	flight management system
FNPT	flight and navigation procedures trainer
FOD	foreign object damage
FOSA	flight operational safety assessment
fpm	feet per minute
FRT	fixed radius transition
FSTD	flight simulation training device
ft	feet
FTD	flight training device
FTE	full time equivalent

FTE	flight technical error
FTL	flight and duty time limitations
g	gram
GAGAN	GPS aided geo augmented navigation
GBAS	ground-based augmentation system
GCAS	ground collision avoidance system
GEN	general
GIDS	ground ice detection system
GLS	GBAS landing system
GM	Guidance Material
GMP	general medical practitioner
GNSS	global navigation satellite system
GPS	global positioning system
GPWS	ground proximity warning system
H	helicopter
HEMS	helicopter emergency medical service
HF	high frequency
Hg	mercury
HHO	helicopter hoist operation
HIALS	high intensity approach lighting system
HIGE	hover in ground effect
HLL	helideck limitations list
HOG E	hover out of ground effect
HoT	hold-over time
hPa	hectopascals
HPL	human performance and limitations
HUD	head-up display
HUDLS	head-up guidance landing system
HUMS	health usage monitor system
IAF	initial approach fix
IALS	intermediate approach lighting system
ICAO	International Civil Aviation Organization
IDE	instruments, data and equipment
IF	intermediate fix
IFR	instrument flight rules
IFSD	in-flight shutdown
IGE	in ground effect

ILS	instrument landing system
IMC	instrument meteorological conditions
in	inches
INS	inertial navigation system
IP	intermediate point
IR	Implementing Rule
IR	instrument rating
IRS	inertial reference system
ISA	international standard atmosphere
ISO	International Organization for Standardization
IV	intravenous
JAA	Joint Aviation Authorities
JAR	Joint Aviation Requirements
kg	kilograms
km	kilometres
kt	knots
LDA	landing distance available
LDP	landing decision point
LED	light-emitting diode
LHS	left hand seat
LIFUS	line flying under supervision
LNAV	lateral navigation
LoA	letter of acceptance
LOC	localiser
LOE	line-oriented evaluation
LOFT	line-oriented flight training
LOQE	line-oriented quality evaluation
LOS	limited obstacle surface
LP	Localiser performance
LPV	localiser performance with vertical guidance
LRCS	long range communication system
LRNS	long range navigation system
LVO	low visibility operation
LVP	low visibility procedures
LVTO	low visibility take-off
m	metres
MALS	medium intensity approach lighting system

MALSF	medium intensity approach lighting system with sequenced flashing lights
MALSR	medium intensity approach lighting system with runway alignment indicator lights
MAPt	missed approach point
MCTOM	maximum certified take-off mass
MDA	minimum descent altitude
MDH	minimum descent height
MEA	minimum en-route altitude
MED	medical
MEL	minimum equipment list
METAR	meteorological aerodrome report
MGA	minimum grid altitude
MHA	minimum holding altitude
MHz	megahertz
MID	midpoint
MLR	manuals, logs and records
MLS	microwave landing system
MLX	millilux
mm	millimetres
MM	multi-mode
MMEL	master minimum equipment list
MNPS	minimum navigation performance specifications
MOC	minimum obstacle clearance
MOCA	minimum obstacle clearance altitude
MOPSC	maximum operational passenger seating configuration
MORA	minimum off-route altitude
MPSC	maximum passenger seating capacity
MSA	minimum sector altitude
MSAS	multi-functional satellite augmentation system
MTCA	minimum terrain clearance altitude
N	North
NADP	noise abatement departure procedure
NALS	no approach lighting system
NCC	non-commercial operations with complex motor-powered aircraft
NCO	non-commercial operations with other-than-complex motor-powered aircraft
N _F	free power turbine speed
N _G	engine gas generator speed
NM	nautical miles

NOTAM	notice to airmen
NOTECHS	non-technical skills evaluation
NOTOC	notification to captain
NPA	non-precision approach
NPA	Notice of Proposed Amendment
NSE	navigation system error
NVD	night vision device
NVG	night vision goggles
NVIS	night vision imaging system
OAT	outside air temperature
OCH	obstacle clearance height
OCL	oceanic clearance
ODALS	omnidirectional approach lighting system
OEI	one-engine-inoperative
OFS	obstacle-free surface
OGE	out of ground effect
OIP	offset initiation point
OM	operations manual
OML	operational multi-pilot limitation
ONC	operational navigation chart
OPS	operations
ORO	Organisation Requirements for Air Operations
OTS CAT II	other than standard category II
PAPI	precision approach path indicator
PAR	precision approach radar
PBE	protective breathing equipment
PBN	performance-based navigation
PC/PT	proficiency check/proficiency training
PCDS	personnel carrying device system
PDA	premature descent alert
PDP	predetermined point
PED	portable electronic device
PIC	pilot-in-command
PIN	personal identification number
PIS	public interest site
PLB	personal locator beacon
PNR	point of no return

POH	pilot's operating handbook
PRM	person with reduced mobility
QAR	quick access recorder
QFE	atmospheric pressure at aerodrome elevation / runway threshold
QNH	atmospheric pressure at nautical height
RA	resolution advisory
RAIM	receiver autonomous integrity monitoring
RAT	ram air turbine
RCC	rescue coordination centre
RCF	reduced contingency fuel
RCLL	runway centre line lights
RF	radius to fix
RF	radio frequency
RFC	route facility chart
RI	ramp inspection
RI	rectification interval
RIE	rectification interval extension
RMA	regional monitoring agency
RNAV	area navigation
RNP	required navigation performance
RNP APCH	RNP approach
RNP AR APCH	RNP approach for which authorisation is required
ROD	rate of descent
RP	rotation point
RTCA	Radio Technical Commission for Aeronautics
RTODAH	rejected take-off distance available (helicopters)
RTODRH	rejected take-off distance required (helicopters)
RTOM	reduced take-off mass
RTZL	runway touchdown zone lights
RVR	runway visual range
RVSM	reduced vertical separation minima
S	South
SAFA	safety assessment of foreign aircraft
SALS	simple approach lighting system
SALSF	simple approach lighting system with sequenced flashing lights
Sap	stabilised approach
SAP	system access parameters

SAR	search and rescue
SAS	stability augmentation system
SBAS	satellite-based augmentation system
SCC	senior cabin crew
SCP	special category of passenger
SDCM	system of differential correction and monitoring
SFE	synthetic flight examiner
SFI	synthetic flight instructor
SID	standard instrument departure
SMM	safety management manual
SMS	safety management system
SNAS	satellite navigation augmentation system
SOP	standard operating procedure
SPA	operations requiring specific approvals
SPECI	aviation selected special weather report
SPO	specialised operations
SRA	surveillance radar approach
SSALF	simplified short approach lighting system with sequenced flashing lights
SSALR	simplified short approach lighting system with runway alignment indicator lights
SSALS	simplified short approach lighting system
SSEC	static source error correction
SSR	secondary surveillance radar
STAR	standard terminal arrival route
STC	supplemental type certificate
TA	traffic advisory
TAC	terminal approach chart
TAS	true airspeed
TAWS	terrain awareness warning system
TC	technical crew
TC	type certificate
TCAS	traffic collision avoidance system
TCCA	Transport Canada Civil Aviation
TCH	type certificate holder
TDP	take-off decision point
TDZ	touchdown zone
THR	threshold
TI	Technical Instructions

TIT	turbine inlet temperature
TLS	target level of safety
TMG	touring motor glider
TODA	take-off distance available (aeroplanes)
TODAH	take-off distance available (helicopters)
TODRH	take-off distance required (helicopters)
TOGA	take-off/go around
TORA	take-off run available
T-PED	transmitting portable electronic device
TRE	type rating examiner
TRI	type rating instructor
TSE	total system error
TVE	total vertical error
TWIP	terminal weather information for pilots
UMS	usage monitoring system
UTC	coordinated universal time
V ₂	take-off safety speed
V ₅₀	stalling speed
V _{AT}	indicated airspeed at threshold
VDF	VHF direction finder
VFR	visual flight rules
VHF	very high frequency
VIS	visibility
VMC	visual meteorological conditions
V _{MO}	maximum operating speed
VNAV	vertical navigation
VOR	VHF omnidirectional radio range
V _T	threshold speed
VTOL	vertical take-off and landing
V _{TOSS}	take-off safety speed
WAAS	wide area augmentation system
WAC	world aeronautical chart
WIFI	wireless fidelity
ZFTT	zero flight-time training

GM3 Annex I Definitions

HELIDECK

The term 'helideck' includes take-off and landing operations on ships and vessels and covers 'shipboard final approach and take off areas (FATOs).

GM4 Annex I Definitions

HEAD-UP GUIDANCE LANDING SYSTEM (HUDLS)

A HUDLS is typically used for primary approach guidance to decision heights of 50 ft.

GM5 Annex I Definitions

HELICOPTER EMERGENCY MEDICAL SERVICES (HEMS) FLIGHT

- (a) A HEMS flight (or more commonly referred to as HEMS mission) normally starts and ends at the HEMS operating base following tasking by the 'HEMS dispatch centre'. Tasking can also occur when airborne, or on the ground at locations other than the HEMS operating base.
- (b) The following elements should be regarded as integral parts of the HEMS mission:
 - (1) flights to and from the HEMS operating site when initiated by the HEMS dispatch centre;
 - (2) flights to and from an aerodrome/operating site for the delivery or pick-up of medical supplies and/or persons required for completion of the HEMS mission; and
 - (3) flights to and from an aerodrome/operating site for refuelling required for completion of the HEMS mission.

GM6 Annex I Definitions

HOSTILE ENVIRONMENT

Those parts of an open-sea area not considered to constitute a hostile environment should be designated by the appropriate authority in the appropriate aeronautical information publication (AIP) or other suitable documentation.

GM7 Annex I Definitions

NIGHT VISION IMAGING SYSTEM (NVIS)

Helicopter components of the NVIS include the radio altimeter, visual warning system and audio warning system.

GM8 Annex I Definitions

OFFSHORE LOCATION

'Offshore location' includes, but is not limited to:

- (a) helidecks;
- (b) shipboard heliports; and
- (c) winching areas on vessels or renewable-energy installations.

GM9 Annex I Definitions

OFFSHORE OPERATIONS

An offshore operation is considered to be a helicopter flight for the purpose of:

- (a) support of offshore oil, gas and mineral exploration, production, storage and transport;
- (b) support to offshore wind turbines and other renewable-energy sources; or
- (c) support to ships including sea pilot transfer.

GM10 Annex I Definitions

COASTLINE

The national definition of coastline should be included by the appropriate authority in the aeronautical information publication (AIP) or other suitable documentation.

GM11 Annex I Definitions

PUBLIC INTEREST SITE

An example of a public interest sites is a landing site based at a hospital located in a hostile environment in a congested area, which due to its size or obstacle environment does not allow the application of performance class 1 requirements that would otherwise be required for operations in a congested hostile environment.

GM12 Annex I Definitions

TECHNICAL INSTRUCTIONS

The ICAO document number for the Technical Instructions is Doc 9284-AN/905.

GM13 Annex I DefinitionsV₁

The first action includes for example: apply brakes, reduce thrust, deploy speed brakes.

GM14 Annex I Definitions

TASK SPECIALISTS

For the purpose of this Regulation, persons that are carried in a specialised operation, e.g. on a parachute flight, sensational flight or scientific research flight, are considered to be task specialists.

GM15 Annex I Definitions

UPSET PREVENTION AND RECOVERY TRAINING (UPRT) DEFINITIONS

‘Aeroplane upset prevention and recovery training’ means a combination of theoretical knowledge and flying training with the aim of providing flight crew with the required competencies to prevent or recover from developing or developed aeroplane upsets.

‘Aeroplane upset’ means an aeroplane in flight unintentionally exceeding the parameters normally experienced in line operations or training, normally defined by the existence of at least one of the following parameters:

- (a) pitch attitude greater than 25 degrees nose up;
- (b) pitch attitude greater than 10 degrees nose down;
- (c) bank angle greater than 45 degrees; or
- (d) within the above parameters, but flying at airspeeds inappropriate for the conditions.

‘Angle of attack (AOA)’ means the angle between the oncoming air, or relative wind, and a defined reference line on the aeroplane or wing.

‘Approach-to-stall’ means flight conditions bordered by the stall warning and stall.

‘Competency’ means a combination of skills, knowledge, and attitudes required to perform a task to the prescribed standard.

‘Developed upset’ means a condition meeting the definition of an aeroplane upset.

‘Developing upset’ means any time the aeroplane begins to unintentionally diverge from the intended flight path or airspeed.

‘Energy state’ means how much of each kind of energy (kinetic, potential or chemical) the aeroplane has available at any given time.

‘Error’ means an action or inaction by the flight crew that leads to deviations from organisational or flight crew intentions or expectations.

‘Error management’ means the process of detecting and responding to errors with countermeasures that reduce or eliminate the consequences of errors, and mitigate the probability of further errors or undesired aircraft states.

‘First indication of a stall’ means the initial aural, tactile or visual sign of an impending stall, which can be either naturally or synthetically induced.

‘Flight crew resilience’ means the ability of a flight crew member to recognise, absorb and adapt to disruptions.

‘Fidelity level’ means the level of realism assigned to each of the defined FSTD features.

‘Flight path’ means the trajectory or path of the aeroplane travelling through the air over a given space of time.

‘Flight path management’ means active manipulation, using either the aeroplanes automation or manual handling, to command the aeroplane flight controls to direct the aeroplane along a desired trajectory.

‘Load factor’ factor means the ratio of a specified load to the weight of the aeroplane, the former being expressed in terms of aerodynamic forces, propulsive forces, or ground reactions.

‘Loss of control in flight (LOCI)’ means a categorisation of an accident or incident resulting from a deviation from the intended flight path.

‘Manoeuvre-based training’ means training that focuses on a single event or manoeuvre in isolation.

‘Negative training’ means training which unintentionally introduces incorrect information or invalid concepts, which could actually decrease rather than increase safety.

‘Negative transfer of training’ means the application (and ‘transfer’) of what was learned in a training environment (i.e., a classroom, an FSTD) to normal practice, i.e. it describes the degree to which what was learned in training is applied to actual normal practices. In this context, negative transfer of training refers to the inappropriate generalisation of knowledge and skill to a situation or setting in normal practice that does not equal the training situation or setting.

‘Post-stall regime’ means flight conditions at an angle of attack greater than the critical angle of attack.

‘Scenario-based training’ means training that incorporates manoeuvres into real-world experiences to cultivate practical flying skills in an operational environment.

‘Stall’ means a loss of lift caused by exceeding the aeroplane’s critical angle of attack.

Note: A stalled condition can exist at any attitude and airspeed, and may be recognised by continuous stall warning activation accompanied by at least one of the following:

- (a) buffeting, which could be heavy at times;
- (b) lack of pitch authority and/or roll control; and
- (c) inability to arrest the descent rate.

‘Stall Event’ means an occurrence whereby the aeroplane experiences conditions associated with an approach-to-stall or a stall.

‘Stall (event) recovery procedure’ means the manufacturer-approved aeroplane-specific stall recovery procedure. If an OEM-approved recovery procedure does not exist, the aeroplane-specific stall recovery procedure developed by the operator, based on the stall recovery template contained in GM5 ORO.FC.220&230, may be used.

‘Stall warning’ means a natural or synthetic indication provided when approaching a stall that may include one or more of the following indications:

- (a) aerodynamic buffeting (some aeroplanes will buffet more than others);
- (b) reduced roll stability and aileron effectiveness;
- (c) visual or aural cues and warnings;
- (d) reduced elevator (pitch) authority;
- (e) inability to maintain altitude or arrest rate of descent; and
- (f) stick shaker activation (if installed).

Note: A stall warning indicates an immediate need to reduce the angle of attack.

‘Startle’ means the initial short-term, involuntary physiological and cognitive reactions to an unexpected event that commence the normal human stress response.

‘Stick pusher’ means a device that, automatically applies a nose down movement and pitch force to an aeroplane’s control columns, to attempt to decrease the aeroplane’s angle of attack. Device activation may occur before or after aerodynamic stall, depending on the aeroplane type.

Note: A stick pusher is not installed on all aeroplane types.

‘Stick shaker’ means a device that automatically vibrates the control column to warn the pilot of an approaching stall.

Note: A stick shaker is not installed on all aeroplane types.

‘Stress (response)’ means the response to a threatening event that includes physiological, psychological and cognitive effects. These effects may range from positive to negative and can either enhance or degrade performance.

‘Surprise’ means the emotionally-based recognition of a difference in what was expected and what is actual.

‘Threat’ means events or errors that occur beyond the influence of the flight crew, increase operational complexity and must be managed to maintain the margin of safety.

'Threat management' means the process of detecting and responding to threats with countermeasures that reduce or eliminate the consequences of threats and mitigate the probability of errors or undesired aircraft states.

'Train-to-proficiency' means approved training designed to achieve end-state performance objectives, providing sufficient assurances that the trained individual is capable to consistently carry out specific tasks safely and effectively.

Note: In the context of this definition, 'train-to-proficiency' can be replaced by 'training-to-proficiency'.

'Undesired aircraft state' means flight crew-induced aircraft position or speed deviation, misapplication of controls, or incorrect systems configuration, associated with a reduction in margins of safety.

Note: Undesired states can be managed effectively, restoring margins of safety, or flight crew response(s) can induce an additional error, incident, or accident.

Note: All countermeasures are necessary flight crew actions. However, some countermeasures to threats, errors and undesired aircraft states that flight crew employ, build upon 'hard'/systemic-based resources provided by the aviation system.

'Unsafe situation' means a situation, which has led to an unacceptable reduction in safety margin.

ANNEX II

Authority Requirements for Air Operations

[PART-ARO]

ARO.GEN.005 Scope

This Annex establishes requirements for the administration and management system to be fulfilled by the Agency and Member States for the implementation and enforcement of Regulation (EC) No 216/2008 and its Implementing Rules regarding civil aviation air operations.

SUBPART GEN: GENERAL REQUIREMENTS

SECTION I *General*

ARO.GEN.115 Oversight documentation

The competent authority shall provide all legislative acts, standards, rules, technical publications and related documents to relevant personnel in order to allow them to perform their tasks and to discharge their responsibilities.

ARO.GEN.120 Means of compliance

- (a) The Agency shall develop acceptable means of compliance (AMC) that may be used to establish compliance with Regulation (EC) No 216/2008 and its Implementing Rules. When the AMC are complied with, the related requirements of the Implementing Rules are met.
- (b) Alternative means of compliance may be used to establish compliance with the Implementing Rules.
- (c) The competent authority shall establish a system to consistently evaluate that all alternative means of compliance used by itself or by organisations and persons under its oversight allow the establishment of compliance with Regulation (EC) No 216/2008 and its Implementing Rules.
- (d) The competent authority shall evaluate all alternative means of compliance proposed by an organisation in accordance with ORO.GEN.120 (b) by analysing the documentation provided and, if considered necessary, conducting an inspection of the organisation.

When the competent authority finds that the alternative means of compliance are in accordance with the Implementing Rules, it shall without undue delay:

- (1) notify the applicant that the alternative means of compliance may be implemented and, if applicable, amend the approval, specialised operation authorisation or certificate of the applicant accordingly; and

- (2) notify the Agency of their content, including copies of all relevant documentation;
 - (3) inform other Member States about alternative means of compliance that were accepted.
- (e) When the competent authority itself uses alternative means of compliance to achieve compliance with Regulation (EC) No 216/2008 and its Implementing Rules it shall:
- (1) make them available to all organisations and persons under its oversight; and
 - (2) without undue delay notify the Agency.

The competent authority shall provide the Agency with a full description of the alternative means of compliance, including any revisions to procedures that may be relevant, as well as an assessment demonstrating that the Implementing Rules are met.

AMC1 ARO.GEN.120(d)(3) Means of compliance

GENERAL

The information to be provided to other Member States following approval of an alternative means of compliance should contain a reference to the Acceptable Means of Compliance (AMC) to which such means of compliance provides an alternative, as well as a reference to the corresponding Implementing Rule, indicating as applicable the subparagraph(s) covered by the alternative means of compliance.

GM1 ARO.GEN.120 Means of compliance

GENERAL

Alternative means of compliance used by a competent authority or by organisations under its oversight may be used by other competent authorities or organisations only if processed again in accordance with ARO.GEN.120 (d) and (e).

ARO.GEN.125 Information to the Agency

- (a) The competent authority shall without undue delay notify the Agency in case of any significant problems with the implementation of Regulation (EC) No 216/2008 and its Implementing Rules.
- (b) The competent authority shall provide the Agency with safety-significant information stemming from the occurrence reports it has received.

ARO.GEN.135 Immediate reaction to a safety problem

- (a) Without prejudice to Directive 2003/42/EC of the European Parliament and of the Council¹ the competent authority shall implement a system to appropriately collect, analyse and disseminate safety information.
- (b) The Agency shall implement a system to appropriately analyse any relevant safety information received and without undue delay provide to Member States and the Commission any information, including recommendations or corrective actions to be taken, necessary for them to react in a timely manner to a safety problem involving products, parts, appliances, persons or organisations subject to Regulation (EC) No 216/2008 and its Implementing Rules.
- (c) Upon receiving the information referred to in (a) and (b), the competent authority shall take adequate measures to address the safety problem.
- (d) Measures taken under (c) shall immediately be notified to all persons or organisations which need to comply with them under Regulation (EC) No 216/2008 and its Implementing Rules. The competent authority shall also notify those measures to the Agency and, when combined action is required, the other Member States concerned.

¹ OJ L 167, 4.7.2003, p. 23.

SECTION II

Management

ARO.GEN.200 Management system

- (a) The competent authority shall establish and maintain a management system, including as a minimum:
- (1) documented policies and procedures to describe its organisation, means and methods to achieve compliance with Regulation (EC) No 216/2008 and its Implementing Rules. The procedures shall be kept up to date and serve as the basic working documents within that competent authority for all related tasks;
 - (2) a sufficient number of personnel to perform its tasks and discharge its responsibilities. Such personnel shall be qualified to perform their allocated tasks and have the necessary knowledge, experience, initial and recurrent training to ensure continuing competence. A system shall be in place to plan the availability of personnel, in order to ensure the proper completion of all tasks;
 - (3) adequate facilities and office accommodation to perform the allocated tasks;
 - (4) a function to monitor compliance of the management system with the relevant requirements and adequacy of the procedures including the establishment of an internal audit process and a safety risk management process. Compliance monitoring shall include a feedback system of audit findings to the senior management of the competent authority to ensure implementation of corrective actions as necessary; and
 - (5) a person or group of persons, ultimately responsible to the senior management of the competent authority for the compliance monitoring function.
- (b) The competent authority shall, for each field of activity, including management system, appoint one or more persons with the overall responsibility for the management of the relevant task(s).
- (c) The competent authority shall establish procedures for participation in a mutual exchange of all necessary information and assistance with other competent authorities concerned including on all findings raised and follow-up actions taken as a result of oversight of persons and organisations exercising activities in the territory of a Member State, but certified or authorised by or making declarations to the competent authority of another Member State or the Agency.
- (d) A copy of the procedures related to the management system and their amendments shall be made available to the Agency for the purpose of standardisation.

AMC1 ARO.GEN.200(a) Management system

GENERAL

- (a) All of the following should be considered when deciding upon the required organisational structure:
- (1) the number of certificates, attestations, authorisations and approvals to be issued;
 - (2) the number of declared organisations;
 - (3) the number of certified or authorised persons and organisations exercising an activity within that Member State, including persons or organisations certified or authorised by other competent authorities;

- (4) the possible use of qualified entities and of resources of other competent authorities to fulfil the continuing oversight obligations;
 - (5) the level of civil aviation activity in terms of:
 - (i) number and complexity of aircraft operated;
 - (ii) size and complexity of the Member State's aviation industry;
 - (6) the potential growth of activities in the field of civil aviation.
- (b) The set-up of the organisational structure should ensure that the various tasks and obligations of the competent authority do not rely solely on individuals. A continuous and undisturbed fulfilment of these tasks and obligations of the competent authority should also be guaranteed in case of illness, accident or leave of individual employees.

GM1 ARO.GEN.200(a) Management system

GENERAL

- (a) The competent authority designated by each Member State should be organised in such a way that:
- (1) there is specific and effective management authority in the conduct of all relevant activities;
 - (2) the functions and processes described in the applicable requirements of Regulation (EC) No 216/2008² and its Implementing Rules and AMCs, Certification Specifications (CSs) and Guidance Material (GM) may be properly implemented;
 - (3) the competent authority's organisation and operating procedures for the implementation of the applicable requirements of Regulation (EC) No 216/2008 and its Implementing Rules are properly documented and applied;
 - (4) all competent authority personnel involved in the related activities are provided with training where necessary;
 - (5) specific and effective provision is made for the communication and interface as necessary with the Agency and the competent authorities of other Member States; and
 - (6) all functions related to implementing the applicable requirements are adequately described.
- (b) A general policy in respect of activities related to the applicable requirements of Regulation (EC) No 216/2008 and its Implementing Rules should be developed, promoted and implemented by the manager at the highest appropriate level; for example the manager at the top of the functional area of the competent authority that is responsible for such activities.
- (c) Appropriate steps should be taken to ensure that the policy is known and understood by all personnel involved, and all necessary steps should be taken to implement and maintain the policy.
- (d) The general policy, whilst also satisfying additional national regulatory responsibilities, should in particular take into account:

² Regulation (EC) No 216/2008 of the European Parliament and of the Council of 20 February 2008 on common rules in the field of civil aviation and establishing a European Aviation Safety Agency, and repealing Council Directive 91/670/EEC, Regulation (EC) No 1592/2002 and Directive 2004/36/EC. OJ L 79, 19.3.2008, p. 1. Regulation as last amended by Commission Regulation (EU) No 6/2013 of 8 January 2013 (OJ L 4, 9.1.2013, p. 34).

- (1) the provisions of Regulation (EC) No 216/2008;
 - (2) the provisions of the applicable Implementing Rules and their AMCs, CSs and GM;
 - (3) the needs of industry; and
 - (4) the needs of the Agency and of the competent authority.
- (e) The policy should define specific objectives for key elements of the organisation and processes for implementing related activities, including the corresponding control procedures and the measurement of the achieved standard.

AMC1 ARO.GEN.200(a)(1) Management system

DOCUMENTED POLICIES AND PROCEDURES

- (a) The various elements of the organisation involved with the activities related to Regulation (EC) No 216/2008 and its Implementing Rules should be documented in order to establish a reference source for the establishment and maintenance of this organisation.
- (b) The documented procedures should be established in a way that facilitates their use. They should be clearly identified, kept up-to-date and made readily available to all personnel involved in the related activities.
- (c) The documented procedures should cover, as a minimum, all of the following aspects:
 - (1) policy and objectives;
 - (2) organisational structure;
 - (3) responsibilities and associated authority;
 - (4) procedures and processes;
 - (5) internal and external interfaces;
 - (6) internal control procedures;
 - (7) training of personnel;
 - (8) cross-references to associated documents;
 - (9) assistance from other competent authorities or the Agency (where required).
- (d) It is likely that the information is held in more than one document or series of documents, and suitable cross-referencing should be provided. For example, organisational structure and job descriptions are not usually in the same documentation as the detailed working procedures. In such cases, it is recommended that the documented procedures include an index of cross-references to all such other related information, and the related documentation should be readily available when required.

AMC1 ARO.GEN.200(a)(2) Management system

QUALIFICATION AND TRAINING — GENERAL

- (a) The competent authority should ensure appropriate and adequate training of its personnel to meet the standard that is considered necessary to perform the work. To ensure personnel remain qualified, arrangements should be made for initial and recurrent training as required.
- (b) The basic capability of the competent authority's personnel is a matter of recruitment and normal management functions in selection of personnel for particular duties. Moreover, the competent

authority should provide training in the basic skills as required for those duties. However, to avoid differences in understanding and interpretation, all personnel should be provided with further training specifically related to Regulation (EC) No 216/2008, its Implementing Rules and related AMC, CSs and GM, as well as related to the assessment of alternative means of compliance.

- (c) The competent authority may provide training through its own training organisation with qualified trainers or through another qualified training source.
- (d) When training is not provided through an internal training organisation, adequately experienced and qualified persons may act as trainers, provided their training skills have been assessed. If required, an individual training plan should be established covering specific training skills. Records should be kept of such training and of the assessment, as appropriate.

AMC2 ARO.GEN.200(a)(2) Management system

QUALIFICATION AND TRAINING — INSPECTORS

- (a) Initial training programme:

The initial training programme for inspectors should include, as appropriate to their role, current knowledge, experience and skills in at least all of the following:

- (1) aviation legislation organisation and structure;
- (2) the Chicago Convention, relevant ICAO annexes and documents;
- (3) the applicable requirements and procedures;
- (4) management systems, including auditing, risk assessment and reporting techniques;
- (5) human factors principles;
- (6) rights and obligations of inspecting personnel of the competent authority;
- (7) 'on-the-job' training;
- (8) suitable technical training appropriate to the role and tasks of the inspector, in particular for those areas requiring approvals.

- (b) Recurrent training programme:

The recurrent training programme should reflect, at least, changes in aviation legislation and industry. The programme should also cover the specific needs of the inspectors and the competent authority.

AMC3 ARO.GEN.200(a)(2) Management system

QUALIFICATION AND TRAINING — CREW RESOURCE MANAGEMENT (CRM)

For the oversight of the operator's CRM training, the inspectors of the competent authority should be qualified and trained as follows:

- (a) Qualification

To fulfil the qualification provisions, inspectors should:

- (1) have adequate knowledge of the relevant flight operations;
- (2) have adequate knowledge of human performance and limitations (HPL);
- (3) have completed initial CRM training;

- (4) have received additional training in the fields of group management, group dynamics and personal awareness; and
 - (5) have experience in the assessment of the effectiveness of training programmes and management systems.
- (b) Training
- The training of inspectors should be both theoretical and practical, and should include:
- (1) in-depth knowledge of the CRM training elements as laid down in Part-ORO; and
 - (2) specific skills for the oversight of the operator's CRM training including the assessment of non-technical skills using proper techniques and methodologies.

GM1 ARO.GEN.200(a)(2) Management System

SUFFICIENT PERSONNEL

- (a) This GM on the determination of the required personnel is limited to the performance of certification, authorisation and oversight tasks, excluding personnel required to perform tasks subject to any national regulatory requirements.
- (b) The elements to be considered when determining required personnel and planning their availability may be divided into quantitative and qualitative elements:
 - (1) Quantitative elements:
 - (i) the estimated number of initial certificates to be issued;
 - (ii) the number of organisations certified by the competent authority;
 - (iii) the number of persons to whom the competent authority has issued a licence, certificate, rating, authorisation or attestation;
 - (iv) the estimated number of persons and organisations exercising their activity within the territory of the Member State and established or residing in another Member State;
 - (v) the number of organisations having declared their activity to the competent authority;
 - (vi) the number of organisations holding a specialised operations authorisation issued by the competent authority.
 - (2) Qualitative elements:
 - (i) the size, nature and complexity of activities of certified, authorised and declared organisations (cf. AMC1 ORO.GEN.200(b)), taking into account:
 - (A) privileges of the organisation;
 - (B) type of approval, scope of approval, multiple certification, authorisation and declared activities;
 - (C) possible certification to industry standards;
 - (D) types of aircraft/flight simulation training devices (FSTDs) operated;
 - (E) number of personnel; and
 - (F) organisational structure, existence of subsidiaries;
 - (ii) the safety priorities identified;

- (iii) the results of past oversight activities, including audits, inspections and reviews, in terms of risks and regulatory compliance, taking into account:
 - (A) number and level of findings;
 - (B) timeframe for implementation of corrective actions; and
 - (C) maturity of management systems implemented by organisations and their ability to effectively manage safety risks, taking into account also information provided by other competent authorities related to activities in the territory of the Member States concerned; and
 - (iv) the size and complexity of the Member State's aviation industry and the potential growth of activities in the field of civil aviation, which may be an indication of the number of new applications and changes to existing certificates and authorisations to be expected.
- (c) Based on existing data from previous oversight planning cycles and taking into account the situation within the Member State's aviation industry, the competent authority may estimate:
 - (1) the standard working time required for processing applications for new certificates (for persons and organisations) and authorisations;
 - (2) the number of new declarations or changed declarations;
 - (3) the number of new certificates and authorisations to be issued for each planning period; and
 - (4) the number of changes to existing certificates and authorisations to be processed for each planning period.
- (d) In line with the competent authority's oversight policy, the following planning data should be determined specifically for each type of organisation certified by the competent authority as well as for declared organisations, including those being authorised:
 - (1) standard number of audits to be performed per oversight planning cycle;
 - (2) standard duration of each audit;
 - (3) standard working time for audit preparation, on-site audit, reporting and follow-up, per inspector;
 - (4) standard number of ramp and unannounced inspections to be performed;
 - (5) standard duration of inspections, including preparation, reporting and follow-up, per inspector;
 - (6) minimum number and required qualification of inspectors for each audit/inspection.
- (e) Standard working time could be expressed either in working hours per inspector or in working days per inspector. All planning calculations should then be based on the same unit (hours or working days).
- (f) It is recommended to use a spreadsheet application to process data defined under (c) and (d), to assist in determining the total number of working hours/days per oversight planning cycle required for certification, authorisation, oversight and enforcement activities. This application could also serve as a basis for implementing a system for planning the availability of personnel.
- (g) For each type of organisation certified or high risk commercial specialised operation authorised by the competent authority, the number of working hours/days per planning period for each

qualified inspector that may be allocated for certification, authorisation, oversight and enforcement activities should be determined, taking into account:

- (1) purely administrative tasks not directly related to oversight and certification/authorisation;
 - (2) training;
 - (3) participation in other projects;
 - (4) planned absence; and
 - (5) the need to include a reserve for unplanned tasks or unforeseeable events.
- (h) The determination of working time available for certification, authorisation, oversight and enforcement activities should also consider:
- (1) the possible use of qualified entities; and
 - (2) possible cooperation with other competent authorities for approvals or authorisations involving more than one Member State.
- (i) Based on the elements listed above, the competent authority should be able to:
- (1) monitor dates when audits and inspections are due and when they have been carried out;
 - (2) implement a system to plan the availability of personnel; and
 - (3) identify possible gaps between the number and qualification of personnel and the required volume of certification/authorisation and oversight.

Care should be taken to keep planning data up-to-date in line with changes in the underlying planning assumptions, with particular focus on risk-based oversight principles.

AMC1 ARO.GEN.200(d) Management system

PROCEDURES AVAILABLE TO THE AGENCY

- (a) Copies of the procedures related to the competent authority's management system and their amendments to be made available to the Agency for the purpose of standardisation should provide at least the following information:
- (1) Regarding continuing oversight functions undertaken by the competent authority, the competent authority's organisational structure with description of the main processes. This information should demonstrate the allocation of responsibilities within the competent authority, and that the competent authority is capable of carrying out the full range of tasks regarding the size and complexity of the Member State's aviation industry. It should also consider overall proficiency and authorisation scope of competent authority personnel.
 - (2) For personnel involved in oversight activities, the minimum professional qualification requirements and experience and principles guiding appointment (e.g. assessment).
 - (3) How the following are carried out: assessing applications and evaluating compliance, issuance of certificates and authorisations, performance of continuing oversight, follow-up of findings, enforcement measures and resolution of safety concerns.
 - (4) Principles of managing exemptions and derogations.
 - (5) Processes in place to disseminate applicable safety information for timely reaction to a safety problem.

-
- (6) Criteria for planning continuing oversight (oversight programme), including adequate management of interfaces when conducting continuing oversight (air operations, flight crew licensing, continuing airworthiness management for example).
 - (7) Outline of the initial training of newly recruited oversight personnel (taking future activities into account), and the basic framework for continuation training of oversight personnel.
- (b) As part of the continuous monitoring of a competent authority, the Agency may request details of the working methods used, in addition to the copy of the procedures of the competent authority's management system (and amendments). These additional details are the procedures and related guidance material describing working methods for competent authority personnel conducting oversight.
- (c) Information related to the competent authority's management system may be submitted in electronic format.

ARO.GEN.205 Allocation of tasks to qualified entities

- (a) Tasks related to the initial certification, specialised operation authorisation or continuing oversight of persons or organisations subject to Regulation (EC) No 216/2008 and its Implementing Rules shall be allocated by Member States only to qualified entities. When allocating tasks, the competent authority shall ensure that it has:
- (1) put a system in place to initially and continuously assess that the qualified entity complies with Annex V to Regulation (EC) No 216/2008.
This system and the results of the assessments shall be documented.
 - (2) established a documented agreement with the qualified entity, approved by both parties at the appropriate management level, which clearly defines:
 - (i) the tasks to be performed;
 - (ii) the declarations, reports and records to be provided;
 - (iii) the technical conditions to be met in performing such tasks;
 - (iv) the related liability coverage; and
 - (v) the protection given to information acquired in carrying out such tasks.
- (b) The competent authority shall ensure that the internal audit process and safety risk management process required by ARO.GEN.200(a)(4) covers all certification, authorisation or continuing oversight tasks performed on its behalf.

GM1 ARO.GEN.205 Allocation of tasks to qualified entities**CERTIFICATION/AUTHORISATION TASKS**

The tasks that may be performed by a qualified entity on behalf of the competent authority include those related to the initial certification, or specialised operations authorisation and continuing oversight of persons and organisations as defined in this Regulation, with the exclusion of the issuance of certificates, authorisations, licences, ratings or approvals.

ARO.GEN.210 Changes in the management system

- (a) The competent authority shall have a system in place to identify changes that affect its capability to perform its tasks and discharge its responsibilities as defined in Regulation (EC) No 216/2008 and its Implementing Rules. This system shall enable it to take action as appropriate to ensure that its management system remains adequate and effective.
- (b) The competent authority shall update its management system to reflect any change to Regulation (EC) No 216/2008 and its Implementing Rules in a timely manner, so as to ensure effective implementation.
- (c) The competent authority shall notify the Agency of changes affecting its capability to perform its tasks and discharge its responsibilities as defined in Regulation (EC) No 216/2008 and its Implementing Rules.

ARO.GEN.220 Record-keeping

- (a) The competent authority shall establish a system of record-keeping providing for adequate storage, accessibility and reliable traceability of:
 - (1) the management system's documented policies and procedures;
 - (2) training, qualification and authorisation of its personnel;
 - (3) the allocation of tasks, covering the elements required by ARO.GEN.205 as well as the details of tasks allocated;
 - (4) certification processes and continuing oversight of certified organisations;
 - (4a) the process of authorisation of a high risk commercial specialised operation and continuing oversight of an authorisation holder;
 - (5) declaration processes and continuing oversight of declared organisations;
 - (6) details of training courses provided by certified organisations, and if applicable, records relating to FSTDs used for such training;
 - (7) oversight of persons and organisations exercising activities within the territory of the Member State, but overseen, certified or authorised by the competent authority of another Member State or the Agency, as agreed between these authorities;
 - (8) oversight of operations of other-than complex motor-powered aircraft by non-commercial operators;
 - (9) the evaluation and notification to the Agency of alternative means of compliance proposed by organisations subject to certification, or authorisation and the assessment of alternative means of compliance used by the competent authority itself;
 - (10) findings, corrective actions and date of action closure;
 - (11) enforcement measures taken;
 - (12) safety information and follow-up measures; and
 - (13) the use of flexibility provisions in accordance with Article 14 of Regulation (EC) No 216/2008.
- (b) The competent authority shall maintain a list of all organisation certificates and specialised operations authorisations it issued as well as declarations it received.

- (c) All records shall be kept for the minimum period specified in this Regulation. In the absence of such indication, records shall be kept for a minimum period of five years subject to applicable data protection law.

AMC1 ARO.GEN.220(a) Record-keeping

GENERAL

- (a) The record-keeping system should ensure that all records are accessible whenever needed within a reasonable time. These records should be organised in a way that ensures traceability and retrievability throughout the required retention period.
- (b) Records should be kept in paper form or in electronic format or a combination of both media. Records stored on microfilm or optical disc form are also acceptable. The records should remain legible and accessible throughout the required retention period. The retention period starts when the record has been created.
- (c) Paper systems should use robust material, which can withstand normal handling and filing. Computer systems should have at least one backup system, which should be updated within 24 hours of any new entry. Computer systems should include safeguards against unauthorised alteration of data.
- (d) All computer hardware used to ensure data backup should be stored in a different location from that containing the working data and in an environment that ensures they remain in good condition. When hardware or software changes take place, special care should be taken that all necessary data continue to be accessible at least through the full period specified in the relevant Subpart or by default in ARO.GEN.220 (c).

AMC1 ARO.GEN.220(a)(1);(2);(3) Record-keeping

COMPETENT AUTHORITY MANAGEMENT SYSTEM

Records related to the competent authority's management system should include, as a minimum and as applicable:

- (a) the documented policies and procedures;
- (b) the personnel files of competent authority personnel, with supporting documents related to training and qualifications;
- (c) the results of the competent authority's internal audit and safety risk management processes, including audit findings and corrective actions; and
- (d) the contract(s) established with qualified entities performing certification, authorisation or oversight tasks on behalf of the competent authority.

AMC1 ARO.GEN.220(a)(4);(4a) Record-keeping

ORGANISATIONS

Records related to an organisation certified or operations authorised by or having declared its activity to the competent authority should include, as appropriate to the type of organisation:

- (a) the application for an organisation approval, a specialised operation authorisation or the declaration received;

- (b) the documentation based on which the approval or authorisation has been granted and any amendments to that documentation;
- (c) the organisation approval certificate or specialised operation authorisation, including any changes;
- (d) a copy of the continuing oversight programme listing the dates when audits are due and when such audits were carried out;
- (e) continuing oversight records, including all audit and inspection records;
- (f) copies of all relevant correspondence;
- (g) details of any exemption and enforcement actions;
- (h) any report from other competent authorities relating to the oversight of the organisation; and
- (i) a copy of any other document approved by the competent authority.

GM1 ARO.GEN.220(a)(4) Record-keeping

ORGANISATIONS — DOCUMENTATION

Documentation to be kept as records in support of the approval includes the management system documentation, including any technical manuals, such as the operations manual, and training manual, that have been submitted with the initial application, and any amendments to these documents.

GM1 ARO.GEN.220(a)(4a) Record-keeping

AUTHORISATION HOLDERS — DOCUMENTATION

Documentation to be kept as records in support of the authorisation of a high risk commercial specialised operation include the risk assessment documentation and related standard operating procedures (SOP), as well as a description of the management system of the proposed operation and a statement that all the documentation sent to the competent authority has been verified by the operator and found in compliance with the applicable requirements. Any amendments to these documents should be documented.

AMC1 ARO.GEN.220(a)(7) Record-keeping

ACTIVITIES PERFORMED IN THE TERRITORY OF A MEMBER STATE BY PERSONS OR ORGANISATIONS ESTABLISHED OR RESIDING IN ANOTHER MEMBER STATE

- (a) Records related to the oversight of activities performed in the territory of a Member State by persons or organisations established or residing in another Member State should include, as a minimum:
 - (1) oversight records, including all audit and inspection records and related correspondence;
 - (2) copies of all relevant correspondence to exchange information with other competent authorities relating to the oversight of such persons/organisations;
 - (3) details of any enforcement measures and penalties; and
 - (4) any report from other competent authorities relating to the oversight of these persons/organisations, including any notification of evidence showing non-compliance with the applicable requirements.
- (b) Records should be kept by the competent authority having performed the audit or inspection and should be made available to other competent authorities at least in the following cases:

-
- (1) serious incidents or accidents;
 - (2) findings through the oversight programme where organisations certified or authorised by another competent authority are involved, to determine the root cause;
 - (3) an organisation being certified, authorised or having approvals in several Member States.
- (c) When records are requested by another competent authority, the reason for the request should be clearly stated.
- (d) The records can be made available by sending a copy or by allowing access to them for consultation.

GM1 ARO.GEN.220 Record-keeping

GENERAL

Records are required to document results achieved or to provide evidence of activities performed. Records become factual when recorded. Therefore, they are not subject to version control. Even when a new record is produced covering the same issue, the previous record remains valid.

SECTION III
Oversight, certification and enforcement

ARO.GEN.300 Oversight

- (a) The competent authority shall verify:
- (1) compliance with the requirements applicable to organisations or type of operations prior to the issue of a certificate, approval or authorisation, as applicable;
 - (2) continued compliance with the applicable requirements of organisations it has certified, specialised operations it has authorised and organisations from whom it received a declaration;
 - (3) continued compliance with the applicable requirements of non-commercial operators of other-than complex motor-powered aircraft; and
 - (4) implementation of appropriate safety measures mandated by the competent authority as defined in ARO.GEN.135(c) and (d).
- (b) This verification shall:
- (1) be supported by documentation specifically intended to provide personnel responsible for safety oversight with guidance to perform their functions;
 - (2) provide the persons and organisations concerned with the results of safety oversight activity;
 - (3) be based on audits and inspections, including ramp and unannounced inspections; and
 - (4) provide the competent authority with the evidence needed in case further action is required, including the measures foreseen by ARO.GEN.350 and ARO.GEN.355.
- (c) The scope of oversight defined in (a) and (b) shall take into account the results of past oversight activities and the safety priorities.
- (d) Without prejudice to the competences of the Member States and to their obligations as set out in ARO.RAMP, the scope of the oversight of activities performed in the territory of a Member State by persons or organisations established or residing in another Member State shall be determined on the basis of the safety priorities, as well as of past oversight activities.
- (e) Where the activity of a person or organisation involves more than one Member State or the Agency, the competent authority responsible for the oversight under (a) may agree to have oversight tasks performed by the competent authority(ies) of the Member State(s) where the activity takes place or by the Agency. Any person or organisation subject to such agreement shall be informed of its existence and of its scope.
- (f) The competent authority shall collect and process any information deemed useful for oversight, including for ramp and unannounced inspections.

AMC1 ARO.GEN.300(a);(b);(c) Oversight**GENERAL**

- (a) The competent authority should assess the organisation and monitor its continued competence to conduct safe operations in compliance with the applicable requirements. The competent authority should ensure that accountability for assessing organisations is clearly defined. This accountability

may be delegated or shared, in whole or in part. Where more than one competent authority is involved, a responsible person should be appointed under whose personal authority organisations are assessed.

- (b) It is essential that the competent authority has the full capability to adequately assess the continued competence of an organisation by ensuring that the whole range of activities is assessed by appropriately qualified personnel.

AMC2 ARO.GEN.300(a);(b);(c) Oversight

EVALUATION OF OPERATIONAL SAFETY RISK ASSESSMENT

As part of the initial certification or the continuing oversight of an operator, the competent authority should normally evaluate the operator's safety risk assessment processes related to hazards identified by the operator as having an interface with its operations. These safety risk assessments should be identifiable processes of the operator's management system.

As part of its continuing oversight, the competent authority should also remain satisfied as to the effectiveness of these safety risk assessments.

- (a) General methodology for operational hazards

The competent authority should establish a methodology for evaluating the safety risk assessment processes of the operator's management system.

When related to operational hazards, the competent authority's evaluation under its normal oversight process should be considered satisfactory if the operator demonstrates its competence and capability to:

- (1) understand the hazards and their consequences on its operations;
- (2) be clear on where these hazards may exceed acceptable safety risk limits;
- (3) identify and implement mitigations, including suspension of operations where mitigation cannot reduce the risk to within safety risk limits;
- (4) develop and execute effectively robust procedures for the preparation and the safe operation of the flights subject to the hazards identified;
- (5) assess the competence and currency of its staff in relation to the duties necessary for the intended operations and implement any necessary training; and
- (6) ensure sufficient numbers of qualified and competent staff for such duties.

The competent authority should take into account that:

- (1) the operator's recorded mitigations for each unacceptable risk identified are in place;
- (2) the operational procedures specified by the operator with the most significance to safety appear to be robust; and
- (3) the staff on which the operator depends in respect of those duties necessary for the intended operations are trained and assessed as competent in the relevant procedures.

EVALUATION OF OPERATORS' VOLCANIC ASH SAFETY RISK ASSESSMENT

In addition to the general methodology for operational hazards, the competent authority's evaluation under its normal oversight process should also assess the operator's competence and capability to:

- (a) choose the correct information sources to use to interpret the information related to volcanic ash contamination forecast and to resolve correctly any conflicts among such sources; and

- (b) take account of all information from its type certificate holders (TCHs) concerning volcanic ash-related airworthiness aspects of the aircraft it operates, and the related pre-flight, in-flight and post flight precautions to be observed.

GM1 ARO.GEN.300(a); (b);(c) Oversight

GENERAL

- (a) Responsibility for the conduct of safe operations lies with the organisation. Under these provisions a positive move is made towards devolving upon the organisation a share of the responsibility for monitoring the safety of operations. The objective cannot be attained unless organisations are prepared to accept the implications of this policy, including that of committing the necessary resources to its implementation. Crucial to the success of the policy is the content of Part-ORO, which requires the establishment of a management system by the organisation.
- (b) The competent authority should continue to assess the organisation's compliance with the applicable requirements, including the effectiveness of the management system. If the management system is judged to have failed in its effectiveness, then this in itself is a breach of the requirements which may, among others, call into question the validity of a certificate, if applicable.
- (c) The accountable manager is accountable to the competent authority as well as to those who may appoint him/her. It follows that the competent authority cannot accept a situation in which the accountable manager is denied sufficient funds, manpower or influence to rectify deficiencies identified by the management system.

GM2 ARO.GEN.300(a);(b);(c) Oversight

VOLCANIC ASH SAFETY RISK ASSESSMENT — ADDITIONAL GUIDANCE

Further guidance on the assessment of an operator's volcanic ash safety risk assessment is given in ICAO Doc 9974 (Flight safety and volcanic ash — Risk management of flight operations with known or forecast volcanic ash contamination).

GM3 ARO.GEN.300(a);(b);(c) Oversight

CHECKLIST FOR CRM TRAINING OVERSIGHT

The following list includes the major elements for the monitoring of the operator's CRM training:

- (a) development of CRM training considering the operator's management system;
- (b) content of the CRM training syllabus;
- (c) qualification of CRM trainer;
- (d) training facilities:
- (1) classroom;
 - (2) flight simulation training device (FSTD);
 - (3) aircraft; and
 - (4) cabin training device;
- (e) training methods:
- (1) classroom training (instructions, presentations and behavioural exercises);

- (2) computer-based training (CBT);
 - (3) line-oriented flight training (LOFT); and
 - (4) check or test;
- (f) training analysis:
- (1) pre-course reading and study;
 - (2) integration of the different training methods;
 - (3) competence and performance of the trainer or instructor;
 - (4) assessment of flight crew members; and
 - (5) effectiveness of training.

GM4 ARO.GEN.300(a);(b);(c) Oversight

OVERSIGHT OF AN OPERATOR CONVERSION COURSE (OCC) FOR MULTI-CREW PILOT LICENCE (MPL) HOLDERS

As part of the initial certification or the continuing oversight of an operator, the competent authority should include the assessment of the OCC provided to MPL holders, who undertake their first conversion course on a new type or at an operator other than the one that was involved in their training for the MPL.

The assessment of the OCC should evaluate whether the operator, in the process of development of the OCC, took the following aspects into account:

- the time elapsed after completion of the initial training, between base training and hiring, and the Line Flying Under Supervision (LIFUS);
- the necessary feedback loop between the Approved Training Organisation (ATO) and the operator involved in the licence training.

AMC1 ARO.GEN.300(a)(2) Oversight

OPERATIONAL APPROVALS ISSUED BY NON-EU STATE OF REGISTRY

When verifying continued compliance of non-commercial operators using an aircraft registered in a third country holding operational approvals for operations in PBN, MNPS and RVSM airspace issued by a non-EU State of Registry, the competent authority should at least assess if:

- (a) the State of registry has established an equivalent level of safety, considering any differences notified to the ICAO Standards for RVSM, RNP, MNPS and MEL; or
- (b) there are reservations on the safety oversight capabilities and records of the State of registry; or
- (c) operators of the State of registry are subject to an operating ban pursuant Regulation (EC) No 2111/2005; or
- (d) relevant findings on the State of registry from audits carried out under international conventions exist; or
- (e) relevant findings on the State of registry from other safety assessment programmes of States exist.

GM1 ARO.GEN.300(d) Oversight

ACTIVITIES WITHIN THE TERRITORY OF THE MEMBER STATE

- (a) Activities performed in the territory of the Member State by persons or organisations established or residing in another Member State include:
 - (1) activities of:
 - (i) organisations certified or authorised by or declaring their activity to the competent authority of any other Member State or the Agency; or
 - (ii) persons performing operations with other-than-complex motor-powered aircraft; and
 - (2) activities of persons holding a licence, certificate, rating, or attestation issued by the competent authority of any other Member State.
- (b) Audits and inspections of such activities, including ramp and unannounced inspections, should be prioritised towards those areas of greater safety concern, as identified through the analysis of data on safety hazards and their consequences in operations.

ARO.GEN.305 Oversight programme

- (a) The competent authority shall establish and maintain an oversight programme covering the oversight activities required by ARO.GEN.300 and by ARO.RAMP.
- (b) For organisations certified by the competent authority, the oversight programme shall be developed taking into account the specific nature of the organisation, the complexity of its activities, the results of past certification and/or oversight activities required by ARO.GEN and ARO.RAMP and shall be based on the assessment of associated risks. It shall include within each oversight planning cycle:
 - (1) audits and inspections, including ramp and unannounced inspections as appropriate; and
 - (2) meetings convened between the accountable manager and the competent authority to ensure both remain informed of significant issues.
- (c) For organisations certified by the competent authority an oversight planning cycle not exceeding 24 months shall be applied.

The oversight planning cycle may be reduced if there is evidence that the safety performance of the organisation has decreased.

The oversight planning cycle may be extended to a maximum of 36 months if the competent authority has established that, during the previous 24 months:

- (1) the organisation has demonstrated an effective identification of aviation safety hazards and management of associated risks;
- (2) the organisation has continuously demonstrated under ORO.GEN.130 that it has full control over all changes;
- (3) no level 1 findings have been issued; and
- (4) all corrective actions have been implemented within the time period accepted or extended by the competent authority as defined in ARO.GEN.350(d)(2).

The oversight planning cycle may be further extended to a maximum of 48 months if, in addition to the above, the organisation has established, and the competent authority has approved, an effective continuous reporting system to the competent authority on the safety performance and regulatory compliance of the organisation itself.

- (d) For organisations declaring their activity to the competent authority, the oversight programme shall be based on the specific nature of the organisation, the complexity of its activities and the data of past oversight activities and the assessment of risks associated with the type of activity carried out. It shall include audits and inspections, including ramp and unannounced inspections, as appropriate.
- (d1) For organisations holding a specialised operations authorisation, the oversight programme shall be established in accordance with (d) and shall also take into account the past and current authorisation process and the validity period of the authorisation.
- (e) For persons holding a licence, certificate, rating, or attestation issued by the competent authority the oversight programme shall include inspections, including unannounced inspections, as appropriate.
- (f) The oversight programme shall include records of the dates when audits, inspections and meetings are due and when such audits, inspections and meetings have been carried out.

AMC1 ARO.GEN.305(b);(d);(d1) Oversight programme

SPECIFIC NATURE AND COMPLEXITY OF THE ORGANISATION, RESULTS OF PAST OVERSIGHT

- (a) When determining the oversight programme for an organisation, the competent authority should consider in particular the following elements, as applicable:
- (1) the implementation by the organisation of industry standards, directly relevant to the organisation's activity subject to this Regulation;
 - (2) the procedure applied for and scope of changes not requiring prior approval;
 - (3) specific approvals held by the organisation;
 - (4) specific procedures implemented by the organisation related to any alternative means of compliance used.
- (b) For the purpose of assessing the complexity of an organisation's management system, AMC1 ORO.GEN.200(b) should be used.
- (c) Regarding results of past oversight, the competent authority should also take into account relevant results of ramp inspections of organisations it has certified or authorised, persons and other organisation having declared their activity or persons performing operations with other-than-complex motor-powered aircraft that were performed in other Member States in accordance with ARO.RAMP.

AMC2 ARO.GEN.305(b) Oversight programme

PROCEDURES FOR OVERSIGHT OF OPERATIONS

- (a) Each organisation to which a certificate has been issued should have an inspector specifically assigned to it. Several inspectors should be required for the larger companies with widespread or varied types of operation. This does not prevent a single inspector being assigned to several companies. Where more than one inspector is assigned to an organisation, one of them should be nominated as having overall responsibility for supervision of, and liaison with, the organisation's management, and be responsible for reporting on compliance with the requirements for its operations as a whole.
- (b) Audits and inspections, on a scale and frequency appropriate to the operation, should cover at least:
- (1) infrastructure,
 - (2) manuals,
 - (3) training,
 - (4) crew records,
 - (5) equipment,
 - (6) release of flight/dispatch,
 - (7) dangerous goods,
 - (8) organisation's management system.
- (c) The following types of inspections should be envisaged, as part of the oversight programme:
- (1) flight inspection,

- (2) ground inspection (documents and records),
- (3) ramp inspection.

The inspection should be a 'deep cut' through the items selected and all findings should be recorded. Inspectors should review the root cause(s) identified by the organisation for each confirmed finding.

Inspectors should be satisfied that the root cause(s) identified and the corrective actions taken are adequate to correct the non-compliance and to prevent re-occurrence.

- (d) Audits and inspections may be conducted separately or in combination. Audits and inspections may, at the discretion of the competent authority, be conducted with or without prior notice to the organisation.
- (e) Where it is apparent to an inspector that an organisation has permitted a breach of the applicable requirements, with the result that air safety has, or might have, been compromised, the inspector should ensure that the responsible person within the competent authority is informed without delay.
- (f) In the first few months of a new operation, inspectors should be particularly alert to any irregular procedures, evidence of inadequate facilities or equipment, or indications that management control of the operation may be ineffective. They should also carefully examine any conditions that may indicate a significant deterioration in the organisation's financial management. When any financial difficulties are identified, inspectors should increase technical surveillance of the operation with particular emphasis on the upholding of safety standards.
- (g) The number or the magnitude of the non-compliances identified by the competent authority will serve to support the competent authority's continuing confidence in the organisation's competence or, alternatively, may lead to an erosion of that confidence. In the latter case, the competent authority should review any identifiable shortcomings of the management system.

GM1 ARO.GEN.305(b) Oversight programme

FINANCIAL MANAGEMENT

Examples of trends that may indicate problems in a new organisation's financial management are:

- (a) significant lay-offs or turnover of personnel;
- (b) delays in meeting payroll;
- (c) reduction of safe operating standards;
- (d) decreasing standards of training;
- (e) withdrawal of credit by suppliers;
- (f) inadequate maintenance of aircraft;
- (g) shortage of supplies and spare parts;
- (h) curtailment or reduced frequency of revenue flights; and
- (i) sale or repossession of aircraft or other major equipment items.

AMC1 ARO.GEN.305(b)(1) Oversight programme

AUDIT

- (a) The oversight programme should indicate which aspects of the approval will be covered with each audit.
- (b) Part of an audit should concentrate on the organisation's compliance monitoring reports produced by the compliance monitoring personnel to determine if the organisation is identifying and correcting its problems.
- (c) At the conclusion of the audit, an audit report should be completed by the auditing inspector, including all findings raised.

AMC2 ARO.GEN.305(b)(1) Oversight programme

RAMP INSPECTIONS

- (a) When conducting a ramp inspection of aircraft used by organisations under its regulatory oversight, the competent authority should, as far as possible, comply with the requirements defined in ARO.RAMP.
- (b) When conducting ramp inspections on other-than-suspected aircraft, the competent authority should take into account the following elements:
 - (1) repeated inspections should be avoided of those organisations for which previous inspections have not revealed safety deficiencies;
 - (2) the oversight programme should enable the widest possible sampling rate of aircraft flying into their territory; and
 - (3) there should be no discrimination on the basis of the organisation's nationality, the type of operation or type of aircraft, unless such criteria can be linked to an increased risk.
- (c) For aircraft other than those used by organisations under its regulatory oversight, when conducting a risk assessment, the competent authority should consider aircraft that have not been ramp inspected for more than 6 months.

AMC1 ARO.GEN.305(b);(c);(d);(d1) Oversight programme

INDUSTRY STANDARDS

- (a) For organisations having demonstrated compliance with industry standards, the competent authority may adapt its oversight programme, in order to avoid duplication of specific audit items.
- (b) Demonstrated compliance with industry standards should not be considered in isolation from the other elements to be considered for the competent authority's risk-based oversight.
- (c) In order to be able to credit any audits performed as part of certification in accordance with industry standards, the following should be considered:
 - (1) the demonstration of compliance is based on certification auditing schemes providing for independent and systematic verification;
 - (2) the existence of an accreditation scheme and accreditation body for certification in accordance with the industry standards has been verified;
 - (3) certification audits are relevant to the requirements defined in Annex III (Part-ORO) and other Annexes to this Regulation as applicable;

- (4) the scope of such certification audits can easily be mapped against the scope of oversight in accordance with Annex III (Part-ORO);
- (5) audit results are accessible to the competent authority and open to exchange of information in accordance with Article 15(1) of Regulation (EC) No 216/2008; and
- (6) the audit planning intervals of certification audits i.a.w. industry standards are compatible with the oversight planning cycle.

AMC1 ARO.GEN.305(c) Oversight programme

OVERSIGHT PLANNING CYCLE

- (a) When determining the oversight planning cycle and defining the oversight programme, the competent authority should assess the risks related to the activity of each organisation and adapt the oversight to the level of risk identified and to the organisation's ability to effectively manage safety risks.
- (b) The competent authority should establish a schedule of audits and inspections appropriate to each organisation's business. The planning of audits and inspections should take into account the results of the hazard identification and risk assessment conducted and maintained by the organisation as part of the organisation's management system. Inspectors should work in accordance with the schedule provided to them.
- (c) When the competent authority, having regard to an organisation's safety performance, varies the frequency of an audit or inspection, it should ensure that all aspects of the operation are audited and inspected within the applicable oversight planning cycle.
- (d) The section(s) of the oversight programme dealing with ramp inspections should be developed based on geographical locations, taking into account aerodrome activity, and focusing on key issues that can be inspected in the time available without unnecessarily delaying the operations.

AMC2 ARO.GEN.305(c) Oversight programme

OVERSIGHT PLANNING CYCLE

- (a) For each organisation certified by the competent authority all processes should be completely audited at periods not exceeding the applicable oversight planning cycle. The beginning of the first oversight planning cycle is normally determined by the date of issue of the first certificate. If the competent authority wishes to align the oversight planning cycle with the calendar year, it should shorten the first oversight planning cycle accordingly.
- (b) The interval between two audits for a particular process should not exceed the interval of the applicable oversight planning cycle.
- (c) Audits should include at least one on-site audit within each oversight planning cycle. For organisations exercising their regular activity at more than one site, the determination of the sites to be audited should consider the results of past oversight, the volume of activity at each site, as well as main risk areas identified.
- (d) For organisations holding more than one certificate, the competent authority may define an integrated oversight schedule to include all applicable audit items. In order to avoid duplication of audits, credit may be granted for specific audit items already completed during the current oversight planning cycle, subject to four conditions:
 - (1) the specific audit item should be the same for all certificates under consideration;

- (2) there should be satisfactory evidence on record that such specific audit items were carried out and that all corrective actions have been implemented to the satisfaction of the competent authority;
- (3) the competent authority should be satisfied that there is no reason to believe standards have deteriorated in respect of those specific audit items being granted a credit;
- (4) the interval between two audits for the specific item being granted a credit should not exceed the applicable oversight planning cycle.

AMC1 ARO.GEN.305(d) Oversight programme

OVERSIGHT DECLARED ORGANISATIONS

- (a) When determining the oversight programme of organisations having declared their activity, the competent authority should make a selection of operators to be inspected/audited based on the elements specified in ARO.GEN.305(d).
- (b) For each selected operator an inspection is a sample inspection of the pre-defined inspection criteria on the basis of key risk elements and the applicable requirements.
- (c) The results of past oversight activities should include information from approval activities, e.g. SPA or from other survey programmes such as ACAM.
- (d) The oversight programme should also include a certain percentage of unannounced inspections.
- (e) The oversight programme should be developed on a yearly basis. All operators should be considered for inclusion into the programme not later than 12 months after the date of the first declaration received. At least one inspection should be performed within each 48-month cycle starting with the date of the first declaration received.
- (f) Additional audit/inspections to specific operators may be included in the oversight programme on the basis of the assessment of associated risks carried out within the occurrences reporting scheme(s).

AMC1 ARO.GEN.305(d1) Oversight programme

OVERSIGHT OF AUTHORISATION HOLDERS

- (a) When determining the oversight programme of high risk commercial specialised operators holding an authorisation specialised operations authorisation holders, the competent authority should assess the risks related to the type of activity carried out by each organisation and adapt the oversight to the level of risk identified and to the organisation's ability to effectively manage safety risks.
- (b) An oversight cycle not exceeding 24 months should be applied. The oversight planning cycle may be extended to a maximum of 48 months if the competent authority has established that during the previous 24 months the organisation has been able to effectively manage safety risks.
- (c) The competent authority should establish a schedule of audits and/or inspections, including unannounced inspections, appropriate to each organisation's business. The planning of audits and inspections should take into account the results of the hazard identification and risk assessment conducted and maintained by the organisation as part of the organisation's management system. Inspectors should work in accordance with the schedule provided to them.

- (d) If the specialised operations authorisation is time limited, the competent authority should adapt the schedule of audits and inspections to the duration of the specialised operation authorisation. Audits or inspections may not be necessary if an authorisation is issued for a single flight or event.
- (e) When scheduling audits and inspections, the competent authority should also take into account the activity conducted by authorised organisations in other Member States. In this case the competent authority should coordinate the audit and inspection schedule with the authority of the Member State in which territory the activity is taking place.
- (f) Additional audits or inspections to specific operators may be included in the oversight programme on the basis of the assessment of associated risks carried out within the occurrences reporting scheme(s).

GM1 ARO.GEN.305(d1) Oversight programme

OVERSIGHT OF AUTHORISATION HOLDERS

Past and current authorisation process refers to relevant results of past and current authorisation and oversight activities.

AMC1 ARO.GEN.305(e) Oversight programme

PERSONS HOLDING A LICENCE, CERTIFICATE, RATING OR ATTESTATION

The oversight of persons holding a licence, certificate, rating or attestation should normally be ensured as part of the oversight of organisations. Additionally, the competent authority should verify compliance with applicable requirements when endorsing or renewing ratings.

To properly discharge its oversight responsibilities, the competent authority should perform a certain number of unannounced verifications.

ARO.GEN.310 Initial certification procedure — organisations

- (a) Upon receiving an application for the initial issue of a certificate for an organisation, the competent authority shall verify the organisation's compliance with the applicable requirements. This verification may take into account the statement referred to in ORO.AOC.100(b).
- (b) When satisfied that the organisation is in compliance with the applicable requirements, the competent authority shall issue the certificate(s), as established in Appendices I and II. The certificate(s) shall be issued for an unlimited duration. The privileges and scope of the activities that the organisation is approved to conduct shall be specified in the terms of approval attached to the certificate(s).
- (c) To enable an organisation to implement changes without prior competent authority approval in accordance with ORO.GEN.130, the competent authority shall approve the procedure submitted by the organisation defining the scope of such changes and describing how such changes will be managed and notified.

AMC1 ARO.GEN.310(a) Initial certification procedure — organisations

VERIFICATION OF COMPLIANCE

- (a) Upon receipt of an application for an air operator certificate (AOC), the competent authority should:
 - (1) assess the management system and processes, including the operator's organisation and operational control system;
 - (2) review the operations manual and any other documentation provided by the organisation; and
 - (3) for the purpose of verifying the organisation's compliance with the applicable requirements, conduct an audit at the organisation's facilities. The competent authority may require the conduct of one or more demonstration flights operated as if they were commercial flights.
- (b) The competent authority should ensure that the following steps are taken:
 - (1) The organisation's written application for an AOC should be submitted at least 90 days before the date of intended operation, except that the operations manual may be submitted later, but not less than 60 days before the date of intended operation. The application form should be printed in language(s) of the competent authority's choosing.
 - (2) An individual should be nominated by the responsible person of the competent authority to oversee, to become the focal point for all aspects of the organisation certification process and to coordinate all necessary activity. The nominated person should be responsible to the responsible person of the competent authority for confirming that all appropriate audits and inspections have been carried out. He/she should also ensure that the necessary specific or prior approvals required by (b)(3) are issued in due course. Of particular importance on initial application is a careful review of the qualifications of the organisations' nominated persons. Account should be taken of the relevance of the nominee's previous experience and known record.
 - (3) Submissions that require the competent authority's specific or prior approval should be referred to the appropriate department of the competent authority. Submissions should include, where relevant, the associated qualification requirements and training programmes.

-
- (c) The ability of the applicant to secure, in compliance with the applicable requirements and the safe operation of aircraft, all necessary training and, where required, licensing of personnel, should be assessed. This assessment should also include the areas of responsibility and the numbers of those allocated by the applicant to key management tasks.
- (d) In order to verify the organisation's compliance with the applicable requirements, the competent authority should conduct an audit of the organisation, including interviews of personnel and inspections carried out at the organisation's facilities.
- The competent authority should only conduct such an audit after being satisfied that the application shows compliance with the applicable requirements.
- (e) The audit should focus on the following areas:
- (1) detailed management structure, including names and qualifications of personnel required by ORO.GEN.210 and adequacy of the organisation and management structure;
 - (2) personnel:
 - (i) adequacy of number and qualifications with regard to the intended terms of approval and associated privileges;
 - (ii) validity of licences, ratings, certificates or attestations as applicable;
 - (3) processes for safety risk management and compliance monitoring;
 - (4) facilities — adequacy with regard to the organisation's scope of work;
 - (5) documentation based on which the certificate should be granted (organisation documentation as required by Part-ORO, including technical manuals, such as operations manual or training manual).
- (f) In case of non-compliance, the applicant should be informed in writing of the corrections that are required.
- (g) When the verification process is complete, the person with overall responsibility, nominated in accordance with (b)(2), should present the application to the person responsible for the issue of an AOC together with a written recommendation and evidence of the result of all investigations or assessments which are required before the operator certificate is issued. Approvals required should be attached to the recommendation. The competent authority should inform the applicant of its decision concerning the application within 60 days of receipt of all supporting documentation. In cases where an application for an organisation certificate is refused, the applicant should be informed of the right of appeal as exists under national law.

ARO.GEN.330 Changes — organisations

- (a) Upon receiving an application for a change that requires prior approval, the competent authority shall verify the organisation's compliance with the applicable requirements before issuing the approval.

The competent authority shall prescribe the conditions under which the organisation may operate during the change, unless the competent authority determines that the organisation's certificate needs to be suspended.

When satisfied that the organisation is in compliance with the applicable requirements, the competent authority shall approve the change.

- (b) Without prejudice to any additional enforcement measures, when the organisation implements changes requiring prior approval without having received competent authority approval as defined in (a), the competent authority shall suspend, limit or revoke the organisation's certificate.
- (c) For changes not requiring prior approval, the competent authority shall assess the information provided in the notification sent by the organisation in accordance with ORO.GEN.130 to verify compliance with the applicable requirements. In case of any non-compliance, the competent authority shall:
- (1) notify the organisation about the non-compliance and request further changes;
 - (2) in case of level 1 or level 2 findings, act in accordance with ARO.GEN.350.

AMC1 ARO.GEN.330 Changes — organisations

AOC HOLDERS

- (a) Changes in nominated persons:
- The competent authority should be informed of any changes to personnel specified in Part-ORO that may affect the certificate or terms of approval/approval schedule attached to it. When an organisation submits the name of a new nominee for any of the persons nominated as per ORO.GEN.210(b), the competent authority should require the organisation to produce a written résumé of the proposed person's qualifications. The competent authority should reserve the right to interview the nominee or call for additional evidence of his/her suitability before deciding upon his/her acceptability.
- (b) A simple management system documentation status sheet should be maintained, which contains information on when an amendment was received by the competent authority and when it was approved.
- (c) The organisation should provide each management system documentation amendment to the competent authority, including for the amendments that do not require prior approval by the competent authority. Where the amendment requires competent authority approval, the competent authority, when satisfied, should indicate its approval in writing. Where the amendment does not require prior approval, the competent authority should acknowledge receipt in writing within 10 working days.
- (d) For changes requiring prior approval, in order to verify the organisation's compliance with the applicable requirements, the competent authority should conduct an audit of the organisation, limited to the extent of the changes. If required for verification, the audit should include interviews and inspections carried out at the organisation's facilities.

GM1 ARO.GEN.330 Changes — organisations

CHANGE OF NAME OF THE ORGANISATION

- (a) On receipt of the application and the relevant parts of the organisation's documentation as required by Part-ORO, the competent authority should re-issue the certificate.
- (b) A name change alone does not require the competent authority to audit the organisation, unless there is evidence that other aspects of the organisation have changed.

ARO.GEN.345 Declaration — organisations

- (a) Upon receiving a declaration from an organisation carrying out or intending to carry out activities for which a declaration is required, the competent authority shall verify that the declaration contains all the information required by Part-ORO and shall acknowledge receipt of the declaration to the organisation.
- (b) If the declaration does not contain the required information, or contains information that indicates non-compliance with applicable requirements, the competent authority shall notify the organisation about the non-compliance and request further information. If deemed necessary the competent authority shall carry out an inspection of the organisation. If the non-compliance is confirmed, the competent authority shall take action as defined in ARO.GEN.350.

AMC1 ARO.GEN.345 Declaration — organisations

ACKNOWLEDGEMENT OF RECEIPT

The competent authority should acknowledge receipt of the declaration in writing within 10 working days.

GM1 ARO.GEN.345 Declaration — organisations

VERIFICATION — DECLARATION

The verification made by the competent authority upon receipt of a declaration does not imply an inspection. The aim is to check whether what is declared complies with applicable regulations.

ARO.GEN.350 Findings and corrective actions — organisations

- (a) The competent authority for oversight in accordance with ARO.GEN.300(a) shall have a system to analyse findings for their safety significance.
- (b) A level 1 finding shall be issued by the competent authority when any significant non-compliance is detected with the applicable requirements of Regulation (EC) No 216/2008 and its Implementing Rules, with the organisation's procedures and manuals or with the terms of an approval, certificate, specialised operation authorisation or with the content of a declaration which lowers safety or seriously hazards flight safety.

The level 1 findings shall include:

- (1) failure to give the competent authority access to the organisation's facilities as defined in ORO.GEN.140 during normal operating hours and after two written requests;
 - (2) obtaining or maintaining the validity of the organisation certificate or specialised operations authorisation by falsification of submitted documentary evidence;
 - (3) evidence of malpractice or fraudulent use of the organisation certificate or specialised operations authorisation; and
 - (4) the lack of an accountable manager.
- (c) A level 2 finding shall be issued by the competent authority when any non-compliance is detected with the applicable requirements of Regulation (EC) No 216/2008 and its Implementing Rules, with the organisation's procedures and manuals or with the terms of an approval, certificate, specialised operation authorisation or with the content of a declaration which could lower safety or hazard flight safety.
- (d) When a finding is detected during oversight or by any other means, the competent authority shall, without prejudice to any additional action required by Regulation (EC) No 216/2008 and its Implementing Rules, communicate the finding to the organisation in writing and request corrective action to address the non-compliance(s) identified. Where relevant, the competent authority shall inform the State in which the aircraft is registered.
- (1) In the case of level 1 findings the competent authority shall take immediate and appropriate action to prohibit or limit activities, and if appropriate, it shall take action to revoke the certificate, specialised operations authorisation or specific approval or to limit or suspend it in whole or in part, depending upon the extent of the level 1 finding, until successful corrective action has been taken by the organisation.
 - (2) In the case of level 2 findings, the competent authority shall:
 - (i) grant the organisation a corrective action implementation period appropriate to the nature of the finding that in any case initially shall not be more than three months. At the end of this period, and subject to the nature of the finding, the competent authority may extend the three-month period subject to a satisfactory corrective action plan agreed by the competent authority; and
 - (ii) assess the corrective action and implementation plan proposed by the organisation and, if the assessment concludes that they are sufficient to address the non-compliance(s), accept these.
 - (3) Where an organisation fails to submit an acceptable corrective action plan, or to perform the corrective action within the time period accepted or extended by the competent authority, the finding shall be raised to a level 1 finding and action taken as laid down in (d)(1).

- (4) The competent authority shall record all findings it has raised or that have been communicated to it and, where applicable, the enforcement measures it has applied, as well as all corrective actions and date of action closure for findings.
- (e) Without prejudice to any additional enforcement measures, when the authority of a Member State acting under the provisions of ARO.GEN.300 (d) identifies any non-compliance with the applicable requirements of Regulation (EC) No 216/2008 and its Implementing Rules by an organisation certified by, or authorised by or declaring its activity to the competent authority of another Member State or the Agency, it shall inform that competent authority and provide an indication of the level of finding.

GM1 ARO.GEN.350 Findings and corrective actions — organisations

TRAINING

For a level 1 finding it may be necessary for the competent authority to ensure that further training by the organisation is carried out and audited by the competent authority before the activity is resumed, dependent upon the nature of the finding.

ARO.GEN.355 Findings and enforcement measures — persons

- (a) If, during oversight or by any other means, evidence is found by the competent authority responsible for oversight in accordance with ARO.GEN.300(a) that shows a non-compliance with the applicable requirements by a person holding a licence, certificate, rating or attestation issued in accordance with Regulation (EC) No 216/2008 and its Implementing Rules, the competent authority shall act in accordance with ARA.GEN.355(a) to (d) of Annex VI (Part-ARA) to Commission Regulation (EU) No 1178/2011³.
- (b) If, during oversight or by any other means, evidence is found showing a non-compliance with the applicable requirements by a person subject to the requirements laid down in Regulation (EC) No 216/2008 and its Implementing Rules and not holding a licence, certificate, rating or attestation issued in accordance with that Regulation and its Implementing Rules, the competent authority that identified the non-compliance shall take any enforcement measures necessary to prevent the continuation of that non-compliance.

GM1 ARO.GEN.355(b) Findings and enforcement measures — persons

GENERAL

This provision is necessary to ensure that enforcement measures will be taken also in cases where the competent authority may not act on the licence, certificate or attestation. The type of enforcement measure will depend on the applicable national law and may include for example the payment of a fine or the prohibition from exercising.

It covers two cases:

- (a) persons subject to the requirements laid down in Regulation (EC) No 216/2008 and its Implementing Rules who are not required to hold a licence, certificate or attestation; and
- (b) persons who are required to hold a licence, rating, certificate or attestation, but who do not hold the appropriate licence, rating, certificate or attestation as required for the activity they perform.

³ OJ L 100, 5.4.2012, p. 1.

ARO.GEN.360 Findings and enforcement measures — all operators

If, during oversight or by any other means, evidence is found showing a non-compliance with the applicable requirements by an operator subject to the requirements laid down in Regulation (EC) No 216/2008 and its Implementing Rules, the competent authority that identified the non-compliance shall take any enforcement measures necessary to prevent the continuation of that non-compliance.

SUBPART OPS: AIR OPERATIONS

SECTION I *Certification of commercial air transport operators*

ARO.OPS.100 Issue of the air operator certificate

- (a) The competent authority shall issue the air operator certificate (AOC) when satisfied that the operator has demonstrated compliance with the elements required in ORO.AOC.100.
- (b) The certificate shall include the associated operations specifications.
- (c) The competent authority may determine specific operational limitations. Such limitations shall be documented in the operations specifications.

ARO.OPS.105 Code-share arrangements

In considering the safety of a code-share agreement involving a third-country operator, the competent authority shall:

- (1) satisfy itself, following the verification by the operator as set out in ORO.AOC.115, that the third-country operator complies with the applicable ICAO standards;
- (2) liaise with the competent authority of the State of the third-country operator as necessary.

AMC1 ARO.OPS.105 Code-share arrangements

SAFETY OF A CODE-SHARE AGREEMENT

- (a) When evaluating the safety of a code-share agreement, the competent authority should check that the:
 - (1) documented information provided by the applicant in accordance with ORO.AOC.115 is complete and shows compliance with the applicable ICAO standards; and
 - (2) operator has established a code-share audit programme for monitoring continuous compliance of the third country operator with the applicable ICAO standards.
- (b) The competent authority should request the applicant to make a declaration covering the above items.
- (c) In case of non-compliance, the applicant should be informed in writing of the corrections which are required.

AMC2 ARO.OPS.105 Code-share arrangements

AUDITS PERFORMED BY A THIRD PARTY PROVIDER

When audits are performed by a third party provider, the competent authority should verify if the third party provider meets the criteria established in AMC2 ORO.AOC.115(b).

ARO.OPS.110 Lease agreements

- (a) The competent authority shall approve a lease agreement when satisfied that the operator certified in accordance with Annex III (Part-ORO) complies with:
- (1) ORO.AOC.110(d), for dry leased-in third country aircraft;
 - (2) ORO.AOC.110(c), for wet lease-in of an aircraft from a third country operator;
 - (3) ORO.AOC.110(e), for dry lease-out of an aircraft to any operator;
 - (4) relevant requirements of continuing airworthiness and air operations, for dry lease-in of an aircraft registered in the EU and wet lease-in of an aircraft from an EU operator.
- (b) The approval of a wet lease-in agreement shall be suspended or revoked whenever:
- (1) the AOC of the lessor or lessee is suspended or revoked;
 - (2) the lessor is subject to an operating ban pursuant to Regulation (EC) No 2111/2005 of the European Parliament and of the Council⁴.
- (c) The approval of a dry lease-in agreement shall be suspended or revoked whenever:
- (1) the certificate of airworthiness of the aircraft is suspended or revoked;
 - (2) the aircraft is included in the list of operators subject to operational restrictions or it is registered in a State of which all operators under its oversight are subject to an operating ban pursuant to Regulation (EC) No 2111/2005.
- (d) When asked for the prior approval of a dry-lease out agreement in accordance with ORO.AOC.110(e), the competent authority shall ensure:
- (1) proper coordination with the competent authority responsible for the continuing oversight of the aircraft, in accordance with Commission Regulation (EC) No 2042/2003⁵, or for the operation of the aircraft, if it is not the same authority;
 - (2) that the aircraft is timely removed from the operator's AOC.
- (e) When asked for prior approval of a dry lease-in agreement in accordance with point ORO.AOC.110(d), the competent authority shall ensure proper coordination with the State of Registry of the aircraft as necessary to exercise the oversight responsibilities of the aircraft.

AMC1 ARO.OPS.110 Lease agreements**WET LEASE-IN**

- (a) Before approving a wet lease-in agreement, the competent authority of the lessee should assess available reports on ramp inspections performed on aircraft of the lessor.
- (b) The competent authority should only approve a wet lease-in agreement if the routes intended to be flown are contained within the authorised areas of operations specified in the AOC of the lessor.

⁴ OJ L 344, 27.12.2005, p. 15.

⁵ OJ L 315, 28.11.2003, p. 1.

AMC2 ARO.OPS.110 Lease agreements

SHORT TERM WET LEASE-IN

The competent authority of the lessee may approve third country operators individually or a framework contract with more than one third country operator in anticipation of operational needs or to overcome operational difficulties taking into account the conditions defined in Article 13(3) of Regulation (EC) No 1008/2008.

GM1 ARO.OPS.110 Lease agreements

APPROVAL

- (a) Except for wet lease-out, approval for an EU operator to lease an aircraft of another operator should be issued by the competent authority of the lessee and the competent authority of the lessor.
- (b) When an EU operator leases an aircraft of an undertaking or person other than an operator, the competent authority of the lessee should issue the approval.

GM2 ARO.OPS.110 Lease agreements

DRY LEASE-OUT

The purpose of the requirement for the competent authority to ensure proper coordination with the authority that is responsible for the oversight of the continuing airworthiness of the aircraft in accordance with Commission Regulation (EC) No 2042/2003⁶ is to ensure that appropriate arrangements are in place to allow:

- (a) the transfer of regulatory oversight over the aircraft, if relevant; or
- (b) continued compliance of the aircraft with the requirements of Commission Regulation (EC) No 2042/2003.

⁶ OJ L 315, 28.11.2003, p. 1.

SECTION Ia
Authorisation of high risk commercial specialised operations

ARO.OPS.150 Authorisation of high risk commercial specialised operations

- (a) Upon receiving an application for the issue of a high risk commercial specialised operations authorisation, the competent authority of the operator shall review the operator's risk assessment documentation and standard operating procedures (SOP), related to one or more planned operations and developed in accordance with the relevant requirements of Annex VIII (Part-SPO).
- (b) When satisfied with the risk assessment and SOP, the competent authority of the operator shall issue the authorisation, as established in Appendix VI. The authorisation may be issued for a limited or an unlimited duration. The conditions under which an operator is authorised to conduct one or more high risk commercial specialised operations shall be specified in the authorisation.
- (c) Upon receiving an application for a change to the authorisation, the competent authority of the operator shall comply with (a) and (b). It shall prescribe the conditions under which the operator may operate during the change, unless the competent authority determines that the authorisation needs to be suspended.
- (d) Upon receiving an application for the renewal of the authorisation, the competent authority of the operator shall comply with (a) and (b). It may take into account the past authorisation process and oversight activities.
- (e) Without prejudice to any additional enforcement measures, when the operator implements changes without having submitted an amended risk assessment and SOP, the competent authority of the operator shall suspend, limit or revoke the authorisation.
- (f) Upon receiving an application for the issue of an authorisation for a cross-border high risk commercial specialised operation, the competent authority of the operator shall review the operator's risk assessment documentation and standard operating procedures (SOP) in coordination with the competent authority of the place where the operation is planned to be conducted. When both authorities are satisfied with the risk assessment and SOP, the competent authority of the operator shall issue the authorisation.

AMC1 ARO.OPS.150 Authorisation of high risk commercial specialised operations

GENERAL

The competent authority should make publicly available a list of activities of high risk commercial specialised operations so that operators are informed when to apply for an authorisation.

AMC1 ARO.OPS.150(a);(b) Authorisation of high risk commercial specialised operations

VERIFICATION OF COMPLIANCE

- (a) For the purpose of verifying the operator's standard operating procedures (SOPs), the competent authority may conduct an audit at the operator's facilities or require the conduct of one or more demonstration flights operated as if they were high risk commercial specialised operations.
- (b) An individual should be nominated by the competent authority to become the focal point for all aspects of the authorisation process and to coordinate all necessary activity. This nominated

person should confirm to the responsible person of the competent authority issuing the authorisation that all appropriate audits and inspections have been carried out.

- (c) When the verification process is complete, the person, nominated in accordance with (b), should present the application to the person responsible for the issuance of an authorisation together with a written recommendation and evidence of the result of the review of the operator's risk assessment documentation and SOPs, which is required before the authorisation is issued. The competent authority should inform the applicant of its decision concerning the application. In cases where an application for an authorisation is refused, the applicant should be informed of the right of appeal as exists under national law.

GM1 ARO.OPS.150(b) Authorisation of high risk commercial specialised operations

LIMITATIONS

The competent authority may issue the authorisation for a limited duration, e.g. for a single event or a defined series of flights, or limit the operating area.

GM1 ARO.OPS.150(c) Authorisation of high risk commercial specialised operations

CHANGE OF NAME OF THE ORGANISATION

- (a) Upon receipt of the application for a change of the authorisation, the competent authority should re-issue the authorisation.
- (b) A name change alone does not require the competent authority to re-assess the risk assessment and SOPs, unless there is evidence that other aspects of the operation have changed.

AMC1 ARO.OPS.150(f) Authorisation of high risk commercial specialised operations

AUTHORISATION OF CROSS-BORDER HIGH RISK COMMERCIAL SPECIALISED OPERATION

- (a) An authorisation for cross-border high risk commercial specialised operations should be issued by the competent authority, when both the competent authority itself and the competent authority of the place where the operation is planned to be conducted are satisfied that the risk assessment and SOPs are appropriate for the area overflown.
- (b) The authorisation should be amended to include those areas for which the operator has received the authorisation to conduct cross-border high risk commercial specialised operation.

GM1 ARO.OPS.150(f) Authorisation of high risk commercial specialised operations

AUTHORISATION OF CROSS-BORDER HIGH RISK COMMERCIAL SPECIALISED OPERATION

Cross-border high risk commercial specialised operation means a high risk commercial specialised operation in a territory other than the Member State than where the operator has its principle place of business.

ARO.OPS.155 Lease agreements

- (a) The competent authority shall approve a lease agreement involving a third country registered aircraft or a third country operator when the SPO operator has demonstrated compliance with ORO.SPO.100.
- (b) The approval of a dry lease-in agreement shall be suspended or revoked whenever the certificate of airworthiness of the aircraft is suspended or revoked.

GM1 ARO.OPS.155 Lease agreements

WET LEASE-IN

Since ICAO has not stipulated globally harmonised standards for specialised operators and their operation, the applicable requirements involving a third country registered aircraft of a third country operator will be of a local or national nature. Therefore, the competent authority approving a wet lease-in agreement is encouraged to collect information on the oversight system of the state of the operator or state of registry, if applicable, in order to have a better understanding of the operation.

GM2 ARO.OPS.155 Lease agreements

LEASE AGREEMENTS BETWEEN OPERATORS REGISTERED IN AN EU MEMBER STATE

No approval is required for any lease agreements between operators having their principle place of business in an EU Member State.

SECTION II
Approvals**ARO.OPS.200 Specific approval procedure**

- (a) Upon receiving an application for the issue of a specific approval or changes thereof, the competent authority shall assess the application in accordance with the relevant requirements of Annex V (Part-SPA) and conduct, where relevant, an appropriate inspection of the operator.
- (b) When satisfied that the operator has demonstrated compliance with the applicable requirements, the competent authority shall issue or amend the approval. The approval shall be specified in:
 - (1) the operations specifications, as established in Appendix II, for commercial air transport operations; or
 - (2) the list of specific approvals, as established in Appendix V, for non-commercial operations and specialised operations.

AMC1 ARO.OPS.200 Specific approval procedure

PROCEDURES FOR THE APPROVAL OF CARRIAGE OF DANGEROUS GOODS

When verifying compliance with the applicable requirements of SPA.DG.100, the competent authority should check that:

- (a) the procedures specified in the operations manual are sufficient for the safe transport of dangerous goods;
- (b) operations personnel are properly trained in accordance with the ICAO *Technical Instructions for the Safe Transport of Dangerous Goods by Air* (ICAO Doc 9284-AN/905); and
- (c) a reporting scheme is in place.

AMC2 ARO.OPS.200 Specific approval procedure

PROCEDURES FOR THE APPROVAL FOR REDUCED VERTICAL SEPARATION MINIMA (RVSM) OPERATIONS

- (a) When verifying compliance with the applicable requirements of Subpart D of Annex V (SPA.RVSM), the competent authority should verify that:
 - (1) each aircraft holds an adequate RVSM airworthiness approval;
 - (2) procedures for monitoring and reporting height keeping errors have been established;
 - (3) a training programme for the flight crew involved in these operations has been established; and
 - (4) operating procedures have been established.
- (b) Demonstration flight(s)

The content of the RVSM application may be sufficient to verify the aircraft performance and procedures. However, the final step of the approval process may require a demonstration flight. The competent authority may appoint an inspector for a flight in RVSM airspace to verify that all relevant procedures are applied effectively. If the performance is satisfactory, operation in RVSM airspace may be permitted.

(c) Form of approval documents

Each aircraft group for which the operator is granted approval should be listed in the approval.

(d) Airspace monitoring

For airspace, where a numerical target level of safety is prescribed, monitoring of aircraft height keeping performance in the airspace by an independent height monitoring system is necessary to verify that the prescribed level of safety is being achieved. However, an independent monitoring check of an aircraft is not a prerequisite for the grant of an RVSM approval.

(1) Suspension, revocation and reinstatement of RVSM approval

The incidence of height keeping errors that can be tolerated in an RVSM environment is small. It is expected of each operator to take immediate action to rectify the conditions that cause an error. The operator should report an occurrence involving poor height keeping to the competent authority within 72 hours. The report should include an initial analysis of causal factors and measures taken to prevent repeat occurrences. The need for follow-up reports should be determined by the competent authority. Occurrences that should be reported and investigated are errors of:

- (i) total vertical error (TVE) equal to or greater than ± 90 m (± 300 ft);
- (ii) altimeter system error (ASE) equal to or greater than ± 75 m (± 245 ft); and
- (iii) assigned altitude deviation equal to or greater than ± 90 m (± 300 ft).

Height keeping errors fall into two broad categories:

- errors caused by malfunction of aircraft equipment; and
- operational errors.

(2) An operator that consistently experiences errors in either category should have approval for RVSM operations suspended or revoked. If a problem is identified that is related to one specific aircraft type, then RVSM approval may be suspended or revoked for that specific type within that operator's fleet.

(3) Operators' actions:

The operator should make an effective, timely response to each height keeping error. The competent authority may consider suspending or revoking RVSM approval if the operator's responses to height keeping errors are not effective or timely. The competent authority should consider the operator's past performance record in determining the action to be taken.

(4) Reinstatement of approval:

The operator should satisfy the competent authority that the causes of height keeping errors are understood and have been eliminated and that the operator's RVSM programmes and procedures are effective. At its discretion and to restore confidence, the competent authority may require an independent height monitoring check of affected aircraft to be performed.

AMC3 ARO.OPS.200 Specific approval procedure

APPROVAL OF HELICOPTER OFFSHORE OPERATIONS

(a) Approval

When verifying compliance with the applicable requirements of Subpart K of Annex V (Part-SPA) to Regulation (EU) No 965/2012, the competent authority should ensure prior to issuing an approval that:

- (1) the hazard identification, risk assessment and risk mitigation processes are in place;
- (2) operating procedures have been established applicable to the area of operation;
- (3) helicopters are appropriately certified and equipped for the area of operation;
- (4) flight crew involved in these operations are trained and checked in accordance with the training and checking programmes established by the operator; and
- (5) all requirements of Part-SPA, Subpart K are met.

(b) Demonstration flight(s)

The final step of the approval process may require a demonstration flight performed in the area of operation. The competent authority may appoint an inspector for a flight to verify that all relevant procedures are applied effectively. If the performance is satisfactory, helicopter offshore operations may be approved.

GM1 ARO.OPS.200 Specific approval procedure

LIMITATIONS FOR HELICOPTER OFFSHORE OPERATIONS

The competent authority may impose limitations related to routes and areas of operation for offshore helicopter operations. Such limitations may be specified in the operations specifications (OPSSPEC) or specific approved documents or in the aeronautical information publication (AIP) or by other means.

For operations over sea areas, limitations may include a maximum significant wave height under which there is a good prospect of recovery of survivors. This should be linked with the available search and rescue capabilities in the different sea areas.

ARO.OPS.205 Minimum equipment list approval

- (a) When receiving an application for initial approval of a minimum equipment list (MEL) or an amendment thereof from an operator, the competent authority shall assess each item affected, to verify compliance with the applicable requirements, before issuing the approval.
- (b) The competent authority shall approve the operator's procedure for the extension of the applicable rectification intervals B, C and D, if the conditions specified in ORO.MLR.105(f) are demonstrated by the operator and verified by the competent authority.
- (c) The competent authority shall approve, on a case-by-case basis, the operation of an aircraft outside the constraints of the MEL but within the constraints of the master minimum equipment list (MMEL), if the conditions specified in ORO.MLR.105 are demonstrated by the operator and verified by the competent authority.

GM1 ARO.OPS.205 Minimum equipment list approval

EXTENSION OF RECTIFICATION INTERVALS

The competent authority should verify that the operator does not use the extension of rectification intervals as a means to reduce or eliminate the need to rectify MEL defects in accordance with the established category limit. The extension of rectification intervals should only be considered valid and justifiable when events beyond the operator's control have precluded rectification.

ARO.OPS.210 Determination of distance or local area

The competent authority may determine a distance or local area for the purpose of operations.

GM1 ARO.OPS.210 Determination of local area

GENERAL

The distance or local area should reflect the local environment and operating conditions.

ARO.OPS.215 Approval of helicopter operations over a hostile environment located outside a congested area

- (a) The Member State shall designate those areas where helicopter operations may be conducted without an assured safe forced landing capability, as described in CAT.POL.H.420.
- (b) Before issuing the approval referred to in CAT.POL.H.420 the competent authority shall have considered the operator's substantiation precluding the use of the appropriate performance criteria.

AMC1 ARO.OPS.215 Approval of helicopter operations over a hostile environment located outside a congested area

APPROVALS THAT REQUIRE ENDORSEMENT

- (a) Whenever the operator applies for an approval in accordance with CAT.POL.H.420 for which an endorsement from another State is required, the competent authority should only grant the approval once endorsement of that other State has been received.
- (b) The Operations Specification should be amended to include those areas for which endorsement was received.

AMC2 ARO.OPS.215 Approval of helicopter operations over a hostile environment located outside a congested area

ENDORSEMENT BY ANOTHER STATE

- (a) Whenever the operator applies for an endorsement to operate over hostile environment located outside a congested area in another State in accordance with CAT.POL.H.420, the competent authority of that other State should only grant the endorsement once it is satisfied that:
 - (1) the safety risk assessment is appropriate to the area overflown; and
 - (2) the operator's substantiation that preclude the use of the appropriate performance criteria are appropriate for the area overflown.
- (b) The competent authority of that other State should inform the competent authority of the Member State responsible for issuing the approval.

ARO.OPS.220 Approval of helicopter operations to or from a public interest site

The approval referred to in CAT.POL.H.225 shall include a list of the public interest site(s) specified by the operator to which the approval applies.

AMC1 ARO.OPS.220 Approval of helicopter operations to or from a public interest site

APPROVALS THAT REQUIRE ENDORSEMENT

Whenever the operator applies for an approval in accordance with CAT.POL.H.225 to conduct operations to or from a public interest site (PIS) for which an endorsement from another State is required, the competent authority should only grant such an approval once endorsement of that other State has been received.

AMC2 ARO.OPS.220 Approval of helicopter operations to or from a public interest site

ENDORSEMENT BY ANOTHER STATE

- (a) Whenever the operator applies for an endorsement to operate to/from a public interest site in another State in accordance with CAT.POL.H.225, the competent authority of that other State should only grant the endorsement once it is satisfied that:
 - (1) the conditions of CAT.POL.H.225 (a)(1) through (5) can be met by the operator at those sites for which endorsement is requested; and
 - (2) the operations manual includes the procedures to comply with CAT.POL.H.225 (b) for these sites for which endorsement is requested.
- (b) The competent authority of that other State should inform the competent authority of the Member State responsible for issuing the approval.

ARO.OPS.225 Approval of operations to an isolated aerodrome

The approval referred to in CAT.OP.MPA.106 shall include a list of the aerodromes specified by the operator to which the approval applies.

GM1 ARO.OPS.225 Approval of operations to an isolated aerodrome

GENERAL

The use of an isolated aerodrome exposes the aircraft and passengers to a greater risk than to operations where a destination alternate aerodrome is available. Whether an aerodrome is classified as an isolated aerodrome or not often depends on which aircraft are used for operating the aerodrome. The competent authority should therefore assess whether all possible means are applied to mitigate the greater risk.

ARO.OPS.230 Determination of disruptive schedules

For the purpose of flight time limitations, the competent authority shall determine, in accordance with the definitions of “early type” and “late type” of disruptive schedules in point ORO.FTL.105 of Annex III, which of those two types of disruptive schedules shall apply to all CAT operators under its oversight.

ARO.OPS.235 Approval of individual flight time specification schemes

- (a) The competent authority shall approve flight time specification schemes proposed by CAT operators if the operator demonstrates compliance with Regulation (EC) No 216/2008 and Subpart FTL of Annex III to this Regulation.
- (b) Whenever a flight time specification scheme proposed by an operator deviates from the applicable certification specifications issued by the Agency, the competent authority shall apply the procedure described in Article 22(2) of Regulation (EC) No 216/2008.
- (c) Whenever a flight time specification scheme proposed by an operator derogates from applicable implementing rules, the competent authority shall apply the procedure described in Article 14(6) of Regulation (EC) No 216/2008.
- (d) Approved deviations or derogations shall be subject, after being applied, to an assessment to determine whether such deviations or derogations should be confirmed or amended. The competent authority and the Agency shall conduct an independent assessment based on information provided by the operator. The assessment shall be proportionate, transparent and based on scientific principles and knowledge.

ARO.OPS.240 Specific approval of RNP AR APCH

- (a) When compliance with the requirements in SPA.PBN.105 has been demonstrated by the applicant, the competent authority shall grant a generic specific approval or a procedure-specific approval for RNP AR APCH.
- (b) In the case of a procedure-specific approval, the competent authority shall:
 - (1) list the approved instrument approach procedures at specific aerodromes in the PBN approval;
 - (2) establish coordination with the competent authorities for these aerodromes, if appropriate; and
 - (3) take into account possible credits stemming from RNP AR APCH specific approvals already issued to the applicant.

GM1 ARO.OPS.240 Specific approval of RNP AR APCH**TEMPORARY LIMITATION ON RVR**

Where operators are new to RNP AR APCH operations and their initial application is for RNP < 0.3, it is appropriate to establish a temporary limitation for RVR minima, until operational experience is gained. This period could be based upon time (e.g. 90 days) and a number of conducted operations, as agreed by the competent authority and the operator.

GM2 ARO.OPS.240 Specific approval of RNP AR APCH

REFERENCES

Additional guidance material for the specific approval of PBN operations, when required, can be found in ICAO Doc 9997 Performance-Based Navigation (PBN) Operational Approval Manual. In particular, a job aid can be found in paragraph 4.7 therein for assessment of applications for RNP AR APCH.

SECTION III
Oversight of operations**ARO.OPS.300 Introductory flights**

The competent authority may establish additional conditions for introductory flights carried out in accordance with Part-NCO in the territory of the Member State. Such conditions shall ensure safe operations and be proportionate.

AMC1 ARO.OPS.300 Introductory flights**MARGINAL ACTIVITY**

The competent authority should publish criteria specifying to which extent it considers an activity marginal and how this is being overseen.

GM1 ARO.OPS.300 Introductory flights**ADDITIONAL CONDITIONS**

For introductory flights carried out in the territory of the Member State, the competent authority may establish additional conditions such as defined area of the operation, time period during which such operations are to be conducted, safety risk assessments to be accomplished, aircraft to be used, specific operating procedures, notification requirements, maximum distance flown, pilot qualification, maximum number of passengers on-board, further restrictions on the maximum take-off mass.

SUBPART RAMP: RAMP INSPECTIONS OF AIRCRAFT OF OPERATORS UNDER THE REGULATORY OVERSIGHT OF ANOTHER STATE

ARO.RAMP.005 Scope

This Subpart establishes the requirements to be followed by the competent authority or the Agency when exercising its tasks and responsibilities regarding the performance of ramp inspections of aircraft used by third country operators or used by operators under the regulatory oversight of another Member State when landed at aerodromes located in the territory subject to the provisions of the Treaty.

ARO.RAMP.100 General

- (a) Aircraft, as well as their crew, shall be inspected against the applicable requirements.
- (b) In addition to conducting ramp inspections included in its oversight programme established in accordance with ARO.GEN.305, the competent authority shall perform a ramp inspection of an aircraft suspected of not being compliant with the applicable requirements.
- (c) Within the development of the oversight programme established in accordance with ARO.GEN.305, the competent authority shall establish an annual programme for the conduct of ramp inspections of aircraft. This programme shall:
 - (1) be based on a calculation methodology that takes into account historical information on the number and nature of operators and their number of landings at its aerodromes, as well as safety risks; and
 - (2) enable the competent authority to give priority to the inspections of aircraft on the basis of the list referred to in ARO.RAMP.105(a).
- (d) When it so deems necessary, the Agency, in cooperation with the Member States in whose territory the inspection shall take place, shall conduct ramp inspections of aircraft to verify compliance with the applicable requirements for the purpose of:
 - (1) certification tasks assigned to the Agency by Regulation (EC) No 216/2008;
 - (2) standardisation inspections of a Member State; or
 - (3) inspections of an organisation to verify compliance with the applicable requirements in potentially unsafe situations.

AMC1 ARO.RAMP.100 General

RAMP INSPECTIONS

- (a) The ramp inspection should normally be performed during a turn-around.
- (b) In addition to the applicable requirements, when inspecting the technical condition of the aircraft, it should be checked against the aircraft manufacturer's standard.

AMC1 ARO.RAMP.100(b) General

SUSPECTED AIRCRAFT

In determining whether an aircraft is suspected of not being compliant with the applicable requirements, the following should be taken into account:

- (a) information regarding poor maintenance of, or obvious damage or defects to an aircraft;
- (b) reports that an aircraft has performed abnormal manoeuvres that give rise to serious safety concerns in the airspace of a Member State;
- (c) a previous ramp inspection that has revealed deficiencies indicating that the aircraft does not comply with the applicable requirements and where the competent authority suspects that these deficiencies have not been corrected;
- (d) previous lists, referred to in ARO.RAMP.105, indicating that the operator or the State of the operator has been suspected of non-compliance;
- (e) evidence that the State in which an aircraft is registered is not exercising proper safety oversight;
or
- (f) concerns about the operator of the aircraft that have arisen from occurrence reporting information and non-compliance recorded in a ramp inspection report on any other aircraft used by that operator;
- (g) information received from EASA Third-Country Operator (TCO) monitoring activities;
- (h) any relevant information collected pursuant to ARO.RAMP.110.

AMC1 ARO.RAMP.100(c)(1) General

ANNUAL PROGRAMME

- (a) Calculation methodology

The competent authority should calculate the number of points to be achieved in the following year. The number of points should be submitted to the Agency before the 1st of September prior to the year for which the points apply. For this purpose, the following formula should be used:

$Q = (Opr_{\geq 12}) + (0.2 * Opr_{< 12}) + (0.001 * Lnd)$, where:

‘Q’ = annual quota;

‘ $Opr_{\geq 12}$ ’ is the number of operators whose aircraft have landed in the previous year at aerodromes located in the Member State at least 12 times;

‘ $Opr_{< 12}$ ’ is the number of operators whose aircraft have landed in the previous year at aerodromes in the territory of the Member State less than 12 times;

‘Lnd’ is the number of landings performed by those operators’ aircraft at aerodromes located in the Member State in the previous year.

- (b) Inspections should be valued differently in accordance with the following criteria:
 - (1) prioritised ramp inspections and the first inspection of a new operator, i.e. who has not been inspected by the state during the past 12 months, conducted on an aerodrome located within a radius ≤ 250 km from the competent authority’s main office have a value of 1.5 points;

- (2) prioritised ramp inspections and the first inspection of a new operator conducted on an aerodrome located within a radius > 250 km from the competent authority's main office have a value of 2.25 points;
- (3) inspections conducted between the hours of 20:00 and 06:00 local time, during weekends or national holidays have a value of 1.25 points;
- (4) inspections conducted on operators for which the previous inspection was performed more than 8 weeks before have a value of 1.25 points;
- (5) any other inspections have a value of 1 point; and
- (6) for specific circumstances falling under two or more of the above situations, the above-mentioned factors may be combined by multiplication (e.g. prioritised inspection performed at an airport located at 600 km from the main office, during the weekend on an operator that was not inspected over the last 3 months will have a value of: $2.25 * 1.25 * 1.25 = 3,52$ points).

AMC2 ARO.RAMP.100(c) General

ANNUAL PROGRAMME – NATIONAL COORDINATOR

A national coordinator should be appointed by each competent authority and tasked with the day-to-day coordination of the programme at national level in order to facilitate the implementation of the programme carried out in the framework of Subpart RAMP within each Member State. The tasks of the national coordinator should include the following:

- (a) entering ramp inspection reports into the centralised database within the timeframe defined in ARO.RAMP.145(a);
- (b) prioritising ramp inspections in accordance with ARO.RAMP.105;
- (c) nominating national representatives for the ramp inspection working groups (on procedures, in-depth analysis, ad hoc analysis);
- (d) acting as a focal point for the training schedules (initial and recurrent training) for all involved national ramp inspection staff, e.g. inspectors, senior inspectors, database users, moderators;
- (e) ensuring that all staff involved in ramp inspections are properly trained and scheduled for recurrent training;
- (f) representing the Member State at the meetings of the European Steering Expert Group (ESSG) on ramp inspections and, when necessary, at other ramp inspection related meetings;
- (g) promoting and implementing the inspector exchange programme described in ARO.RAMP.115(e);
- (h) providing support in handling requests for disclosure of data related to information recorded and reported pursuant to ARO.RAMP.145;
- (i) ensuring distribution of new legislation and latest versions of procedures to ramp inspection staff;
- (j) organising regular meetings with all ramp inspection staff to maintain a high quality standard regarding:
 - (1) any changes/updates to requirements relating to ramp inspections of aircraft of operators under the regulatory oversight of another state;
 - (2) feedback on quality issues regarding reports, e.g. incorrect entries, mistakes, omissions, etc.;

- (k) implementing a national ramp inspection quality control system and, as far as practicable, making use of the workflow function which is available in the centralised database referred to in ARO.RAMP.150(b)(2);
- (l) managing the access of national operators and the competent authority's staff to the centralised database referred to in ARO.RAMP.150(b)(2);
- (m) act as a sectorial focal point in the domain of ramp inspections in the context of standardisation activities performed by the Agency pursuant to Regulation (EU) No 628/2013;
- (n) proposing appropriate team members for ramp inspection standardisation visits in accordance with Article 6.2 of Commission Regulation (EU) No 628/2013.
- (o) provide information to the Agency, the Commission and the Member States on contacts with authorities and operators.

AMC3 ARO.RAMP.100(c) General

ANNUAL PROGRAMME

- (a) The annual programme for the performance of ramp inspections should make use of information about prioritised aircraft (available in the centralised database and published regularly by the Agency). The annual programme should include:
 - (1) a long-term planning of inspections of those aircraft suspected of not being compliant with applicable requirements, for which the schedule is known to the competent authority. Information leading to a suspicion could originate from the elements described in AMC1 ARO.RAMP.100(b).
 - (2) a short term planning of inspections, if information leading to the suspicion and/or information on the arrival date and time is not known well in advance. Such information might be originating from, but should not be limited to, the circumstances listed in AMC1 ARO.RAMP.100(b).
- (b) An inspector may also perform inspections of aircraft not being prioritised or aircraft not being suspected during random inspections (so called 'spot checks'), which are conducted in the absence of any suspicion of non-compliance, provided that the competent authority has established the relevant procedures. Such procedures should contain instructions taking into account the following principles:
 - (1) Repetitive inspections of those operators where previous inspections have not revealed safety deficiencies should be avoided, unless they form part of a series of partial inspections (due to time limitations) with the intention to cover the complete checklist.
 - (2) A selection of the widest possible sampling rate of the operator population flying into the territory of the Member State. However, some operators operate flights only to one or a very limited number of Member States. The involved States should consider inspecting those operators regularly even more if these operators or aircraft are included in the list for prioritised ramp inspections referred to in ARO.RAMP.105;
 - (3) Non-discrimination based on the nationality of the operator, the type of operation or type of aircraft.
- (c) By using the information sources and the information specified in AMC1 ARO.RAMP.100(b) and AMC1 ARO.RAMP.110, competent authorities should use the database in order to enable inspectors to verify the rectification of previously found non-compliance and to select the items to be inspected if the time available does not permit full inspection.

GM1 ARO.RAMP.100(c) General

ANNUAL PROGRAMME

In addition to the ramp inspection national coordinator, the competent authority can appoint a coordinator for national operators to act as the focal point for other Member States regarding ramp inspections performed on operators under its oversight.

GM1 ARO.RAMP.100(c)(1) General

NUMBER OF INSPECTION POINTS

The quotation is a statistical assumption only and does not necessarily mean that operators in the group 'Opr_{≥12}' always need to be inspected. As deemed necessary by the inspecting authorities, operators may be inspected more than once (taking into account AMC2 ARO.GEN.305(b)(1)) whilst sticking to the calculated number of points; as a result, some operators might not be inspected in any given year.

ARO.RAMP.105 Prioritisation criteria

- (a) The Agency shall provide competent authorities with a list of operators or aircraft identified as presenting a potential risk, for the prioritisation of ramp inspections.
- (b) This list shall include:
- (1) operators of aircraft identified on the basis of the analysis of available data in accordance with ARO.RAMP.150(b)(4);
 - (2) operators or aircraft communicated to the Agency by the European Commission and identified on the basis of:
 - (i) an opinion expressed by the Air Safety Committee (ASC) within the context of the implementation of Regulation (EC) No 2111/2005 that further verification of effective compliance with relevant safety standards through systematic ramp inspections is necessary; or
 - (ii) information obtained by the European Commission from the Member States pursuant to Article 4(3) of Regulation (EC) No 2111/2005;
 - (3) aircraft operated into the territory subject to the provisions of the Treaty by operators included in Annex B of the list of operators subject to an operating ban pursuant to Regulation (EC) No 2111/2005;
 - (4) aircraft operated by operators certified in a State exercising regulatory oversight over operators included in the list referred to in (3);
 - (5) aircraft used by a third-country operator that operates into, within or out of the territory subject to the provisions of the Treaty for the first time or whose authorisation issued in accordance with ART.GEN.205 is limited or reinstated after suspension or revocation.
- (c) The list shall be produced, in accordance with procedures established by the Agency, after every update of the Community list of operators subject to an operating ban pursuant to Regulation (EC) No 2111/2005, and in any case at least once every four months.

ARO.RAMP.110 Collection of information

The competent authority shall collect and process any information deemed useful for conducting ramp inspections.

AMC1 ARO.RAMP.110 Collection of information**COLLECTION OF INFORMATION**

The information should include:

- (a) important safety information available, in particular, through:
- (1) pilot reports;
 - (2) maintenance organisation report;
 - (3) incident reports;
 - (4) reports from other organisations, independent from the inspection authorities;
 - (5) complaints; and

-
- (6) information received from whistleblowers (such as, but not limited to, ground handling or maintenance personnel) regarding poor maintenance, obvious damage or defects, incorrect loading, etc.
- (b) information on action(s) taken subsequent to a ramp inspection, such as:
- (1) aircraft grounded;
 - (2) aircraft or operator banned from the Member State pursuant to Article 6 of Regulation (EC) No 2111/2005 of the European Parliament and of the Council⁷;
 - (3) corrective action required;
 - (4) contacts with the operator's competent authority; and
 - (5) restrictions on flight operations.
- (c) follow-up information concerning the operator, such as:
- (1) implementation of corrective action(s); and
 - (2) recurrence of non-compliance.

⁷ Regulation (EC) No 2111/2005 of the European Parliament and of the Council of 14 December 2005 on the establishment of a Community list of air carriers subject to an operating ban within the Community and on informing air transport passengers of the identity of the operating air carrier, and repealing Article 9 of Directive 2004/36/EC (OJ L 344, 27.12.2005, p. 15).

ARO.RAMP.115 Qualification of ramp inspectors

- (a) The competent authority and the Agency shall have qualified inspectors to conduct ramp inspections.
- (b) Ramp inspectors shall:
 - (1) possess the necessary aeronautical education or practical knowledge relevant to their area(s) of inspection;
 - (2) have successfully completed:
 - (i) appropriate specific theoretical and practical training, in one or more of the following areas of inspection:
 - (A) flight deck;
 - (B) cabin safety;
 - (C) aircraft condition;
 - (D) cargo;
 - (ii) appropriate on-the-job training delivered by a senior ramp inspector appointed by the competent authority or the Agency;
 - (3) maintain the validity of their qualification by undergoing recurrent training and by performing a minimum of 12 inspections in every 12-month period.
- (c) The training in (b)(2)(i) shall be delivered by the competent authority or by any training organisation approved in accordance with ARO.RAMP.120(a).
- (d) The Agency shall develop and maintain training syllabi and promote the organisation of training courses and workshops for inspectors to improve the understanding and uniform implementation of this Subpart.
- (e) The Agency shall facilitate and coordinate an inspector exchange programme aimed at allowing inspectors to obtain practical experience and contributing to the harmonisation of procedures.

AMC1 ARO.RAMP.115(a) Qualification of ramp inspectors

BACKGROUND KNOWLEDGE AND EXPERIENCE

The background knowledge and/or working experience of the inspector determines the privileges of the inspector. The competent authority should determine what the inspector is entitled to inspect, taking into account the following considerations:

- (a) background knowledge;
- (b) working experience; and
- (c) interrelation of the inspection item with other disciplines (e.g. a former cabin crew member may require additional training on minimum equipment list (MEL) issues before being considered eligible for inspection of safety items in the cabin).

AMC1 ARO.RAMP.115(b)(1) Qualification of ramp inspectors

ELIGIBILITY CRITERIA

- (a) The candidate should be considered eligible to become a ramp inspector provided he/she meets the following criteria:

- (1) has good knowledge of the English language attested by a valid language proficiency certificate; and
- (2) education and experience over the previous 5 years in accordance with one of the following items:
 - (i) has successfully completed post-secondary education with a duration of at least 3 years and after that at least 2 years aeronautical experience in the field of aircraft operations or maintenance, or personnel licensing;
 - (ii) has or has had a commercial/airline transport pilot licence and preferably carried out such duties for at least 2 years;
 - (iii) has or has had a flight engineer licence and preferably carried out such duties for at least 2 years;
 - (iv) has been a cabin crew member and preferably carried out such duties in commercial air transport for at least 2 years;
 - (v) has been licensed as maintenance personnel and preferably exercised the privileges of such a licence for at least 2 years;
 - (vi) has successfully completed professional training in the field of air transport of dangerous goods and preferably after that at least 2 years of experience in this field; or
 - (vii) has successfully completed post-secondary aeronautical education with a duration of at least 3 years.

GM1 ARO.RAMP.115(b)(1) Qualification of ramp inspectors

ENGLISH LANGUAGE PROFICIENCY CERTIFICATE

A valid language proficiency certificate means a certificate such as ICAO English Proficiency Level 4, Common European Framework of Reference for Languages: Level B2, or another equivalent certificate.

AMC1 ARO.RAMP.115(b)(2) Qualification of ramp inspectors

SENIOR RAMP INSPECTORS

- (a) The competent authority should appoint senior ramp inspectors provided they meet the qualification criteria established by that competent authority. These qualification criteria should contain at least the following requirements:
 - (1) the appointee has been a qualified ramp inspector over the 3 years prior to his/her appointment;
 - (2) the appointee has performed a minimum of 72 ramp inspections during the 36 months prior to the appointment, evenly spread over this period; and
 - (3) the senior ramp inspector will remain qualified only if performing at least 24 ramp inspections during any 12-month period after his/her initial qualification.
- (b) If the competent authority does not have senior ramp inspectors to conduct on-the-job training, such training should be performed by a senior ramp inspector from another State.
- (c) Additional factors to be considered when nominating senior ramp inspectors include knowledge of training techniques, professionalism, maturity, judgment, integrity, safety awareness, communication skills, personal standards of performance and a commitment to quality.

- (d) If a senior ramp inspector should lose his/her qualification as a result of failure to reach the minimum number of inspections mentioned in paragraph (a)(3) above, he/she should be re-qualified by the Member State authority by performing at least four inspections under the supervision of a senior ramp inspector, within a maximum period of 2 months.
- (e) Senior ramp inspectors, like any other inspectors, should also receive recurrent training according to the frequency mentioned in paragraph (b) of AMC1 ARO.RAMP.115(b)(3).

AMC2 ARO.RAMP.115(b)(2) Qualification of ramp inspectors

SCOPE AND DURATION OF INITIAL TRAINING

Initial training should encompass:

- initial theoretical training,
- practical training, and
- on-the-job training.

(a) Initial theoretical training

- (1) The scope of the initial theoretical training is to familiarise the inspectors with the framework and the European dimension of the Ramp Inspection Programme, and with the common inspection, finding categorisation, reporting and follow-up procedures. The primary scope of the theoretical training is not the transfer of technical (operational, airworthiness, etc.) knowledge. The trainees should possess such knowledge, either from previous work experience or through specialised training, prior to attending the theoretical course. The duration of the initial theoretical training should be no less than 3 training days.
- (2) In case an integrated course is delivered (consisting of both the transfer of technical knowledge and specific ramp inspection information), the duration of the course should be extended accordingly.
- (3) The initial theoretical training shall be conducted in accordance with the syllabus in AMC1 ARO.RAMP.115(b)(2)(i).

(b) Practical training

- (1) The scope of practical training is to instruct on inspection techniques and specific areas of attention without any interference with the flight crew. Preferably, this should be done in a non-operational environment (e.g. on an aircraft in a maintenance hangar). Alternatively, aircraft with an adequate turnaround time may be used. In the latter case, the flight and/or ground crew should be informed about the training character of the inspection.
- (2) The duration of the practical training should be no less than 1 training day. The competent authority may decide to lengthen the training based on the level of expertise of the attendees. Practical training may be split into several sessions provided an adequate training tracking system is in place.
- (3) The practical training should be conducted in accordance with the syllabus in AMC2 ARO RAMP.115(b)(2)(i).

ON-THE-JOB TRAINING

(c) Scope of on-the-job training

- (1) The objective of the on-the-job training should be to familiarise the trainees with the particularities of performing a ramp inspection in a real, operational environment. The

competent authority should ensure that on-the-job training is undertaken only by trainees that have successfully completed theoretical and practical training.

- (2) The competent authority should ensure that the area of expertise of the trainee is compatible with the one of the senior ramp inspector delivering on-the-job training.
 - (3) When selecting the operators to be inspected during the on-the-job training programme, the senior ramp inspector should ensure:
 - (i) that the training can be performed on a sufficient level but without undue hindrance or delay of the inspected operator; and
 - (ii) that the ramp inspections are conducted on different operators (i.e., EU operators, third country operators), different aircraft types and aircraft configurations (i.e., jet and propeller aircraft, single aisle and wide-body aeroplanes, passenger operations and cargo operations), different types of operations (i.e., commercial and non-commercial operations, long-haul and short-haul operations).
 - (4) On-the-job training should comprise two phases:
 - (i) observing inspector: during this phase the trainee should accompany and observe the senior ramp inspector when performing a series of ramp inspections (including the preparation of the inspection and post-inspection activities: reporting, follow-up); and
 - (ii) inspector under supervision: during this phase the trainee should gradually start to perform ramp inspections under the supervision and guidance of the senior ramp inspector.
- (d) Duration and conduct of on-the-job training
- (1) The duration of the on-the-job training should be customised to the particular training needs of every trainee. As a minimum, the on-the-job training programme should contain at least six observed ramp inspections and six ramp inspections performed under the supervision of the senior ramp inspector, over a period of a maximum of 6 months. In general, on-the-job training should start as soon as possible after the completion of the practical training and cover all inspection items that the inspector will be privileged to inspect.

Appropriate records should be maintained for each trainee documenting the training received (when the trainee is observing the inspection) and his/her ability to effectively perform ramp inspections (under supervision). For this purpose, the senior ramp inspector should use a checklist containing the applicable elements presented in AMC4 ARO.RAMP.115(b)(2). The on-the-job training may be given by more than one senior ramp inspector.

- (2) Before starting on-the-job training the trainee should be briefed with regard to the general objectives and working methods of the training.
 - (3) Before every inspection the trainee should be briefed with regard to the particular objectives and lessons to be learned during this inspection.
 - (4) After every day of inspection the trainee should be debriefed with regard to his/her performance and progress and areas where improvement is needed.
- (e) Elements to be covered during the on-the-job training

On-the-job training should address the following elements. However, some of the situations described below do not happen very often (i.e. grounding of an aircraft) and should, therefore, be presented by the senior ramp inspector during one of the debriefings.

- (1) Preparation of an inspection:
 - (i) use of the centralised database to prepare an inspection;
 - (ii) other sources of information (such as passenger complaints, maintenance organisation reports, air traffic control (ATC) reports);
 - (iii) areas of concern and/or open findings;
 - (iv) retrieval of updated reference materials: Notices to Airmen (NOTAMs), navigation and weather charts;
 - (v) selection of operator(s) to be inspected (oversight programme, priority list);
 - (vi) task allocation among members of a ramp inspection team; and
 - (vii) daily/weekly/monthly ramp inspection schedule.
- (2) Administrative issues:
 - (i) ramp inspector's credentials, rights and obligations;
 - (ii) special urgency procedures (if any);
 - (iii) national (local) aerodrome access procedures;
 - (iv) safety and security airside procedures; and
 - (v) ramp inspector kit (electric torch, fluorescent vest, ear plugs, digital camera, checklists, etc.).
- (3) Cooperation with airport and air navigation services to obtain actual flight information, parking position, time of departure, etc.
- (4) Ramp inspection:
 - (i) introduction to the pilot-in-command/commander, flight crew, cabin crew, ground crew;
 - (ii) inspection items: according to the area of expertise of the trainee;
 - (iii) findings (identification, categorisation, reporting, evidencing);
 - (iv) corrective actions — class 2;
 - (v) corrective actions — class 3:
 - (A) Class 3a) enforcement of restriction(s) on aircraft flight operations (cooperation with other services/authorities to enforce a restriction);
 - (B) Class 3b) request of an immediate corrective action(s), satisfactory completion of an immediate corrective action;
 - (C) Class 3c) grounding of an aircraft: notification of the grounding decision to the aircraft commander; national procedures to prevent the departure of a grounded aircraft; communication with the State of operator/registry;
 - (vi) Proof of Inspection:
 - (A) completion and delivery of the Proof of Inspection report; and
 - (B) request of acknowledgement of receipt (document or a refusal to sign).
- (5) Human factors elements:
 - (i) cultural aspects;

- (ii) resolution of disagreements and/or conflicts; and
 - (iii) crew stress.
- (f) Assessment of trainees

The assessment of the trainee should be done by the senior ramp inspector while the trainee is performing ramp inspections under supervision. The trainee should be considered to have successfully completed the on-the-job training only after demonstrating to the senior ramp inspector that he/she possess the professional capacity, knowledge, judgment and ability to perform ramp inspections in accordance with the requirements of this Subpart.

AMC3 ARO.RAMP.115(b)(2) Qualification of ramp inspectors

QUALIFICATION OF THE INSPECTOR AFTER SUCCESSFUL COMPLETION OF TRAINING

Qualification of the inspector after successful completion of training

- (a) Successful completion of theoretical training should be demonstrated by passing an evaluation by the competent authority or by the approved training organisation who has delivered the training.
- (b) Successful completion of practical and on-the-job training should be assessed by the senior ramp inspector providing on-the-job training, through evaluation of the trainee's ability to effectively perform ramp inspections in an operational environment.
- (c) The competent authority should issue a formal qualification statement for each qualified inspector listing the inspecting privileges.
- (d) The background knowledge and working experience of the inspector should determine the privileges of the inspector (the scope of his/her inspection; what he/she is entitled to inspect). The numerous varieties in backgrounds of the candidate inspectors make it impossible to issue a full set of templates showing the background-privileges relation. It is, therefore, up to the competent authority to determine the eligibility and the related privileges for the inspector, whereby the following should be considered:
 - (1) background knowledge;
 - (2) working experience; and
 - (3) interrelation of the inspection item with other disciplines (e.g. former cabin crew member may require additional training on MEL issues before being considered eligible for safety items in the cabin).
- (e) The competent authority should issue the qualification statement only after the candidate has successfully completed the theoretical, practical and on-the-job-training.
- (f) The competent authority should put in place a system that will ensure that their inspectors meet at all times the qualification criteria with regard to eligibility, training and recent experience.

AMC4 ARO.RAMP.115(b)(2) Qualification of ramp inspectors

CHECKLIST ON-THE-JOB TRAINING OF INSPECTORS

On-the-Job Training of Ramp Inspection Inspectors	
Competent Authority	Senior ramp inspector:
Name of trainee:	Place:

Date:		Ramp Inspection Number:		
Operator:		A/C Registration:	A/C Type:	
A	Flight deck	Check: (Description/ notes)	Observation	Under Supervision
General				
1	General condition	<ul style="list-style-type: none"> • inappropriately pulled circuit breakers • reinforced flight crew compartment door, if required • crew baggage • flight crew seats 	<input type="checkbox"/>	<input type="checkbox"/>
		Note:		
2	Emergency exit	<ul style="list-style-type: none"> • Are exits serviceable (if not, check MEL limitations) • Possible obstacles • emergency exits (serviceability) • escape ropes (secured or not) 	<input type="checkbox"/>	<input type="checkbox"/>
		Note:		
3	Equipment	<p>ACAS II/TCAS:</p> <ul style="list-style-type: none"> • Presence • System test/passed <p>8.33 kHz: (if required)</p> <ul style="list-style-type: none"> • Radio channel spacing <p>RNAV:</p> <ul style="list-style-type: none"> • Authorisation to perform operations in RNAV airspace. <p>TAWS/E-GPWS:</p> <ul style="list-style-type: none"> • Presence • TAWS/SRPBZ for forward looking terrain avoidance function • Data Base of system (content and update) • System test (if possible) <p>MNPS</p> <ul style="list-style-type: none"> • Special authorisation • Cockpit Voice Recorder • System test (if possible) <p>RVSM: (if required)</p> <ul style="list-style-type: none"> • Presence • Serviceability 	<input type="checkbox"/>	<input type="checkbox"/>
		Note:		

Documentation				
4	Manuals	<ul style="list-style-type: none"> • Presence of the applicable parts of the operations manual • Up-to-date • Competent authority approval where applicable content (complies with the requirements) • Presence of aircraft flight manual / performance data • Differences regarding manuals of aircraft of ex-Soviet design (e.g. Rukowodstwo on former Commonwealth of Independent States (CIS) built aircraft. 	<input type="checkbox"/>	<input type="checkbox"/>
		Note:		
5	Checklists	<ul style="list-style-type: none"> • Available/within reach • Tidiness/cleanness • Normal • Abnormal • Emergency • Up-to-date/not for training, etc. • Content (compliance with the operator procedures) • Appropriate for aircraft configuration being used 	<input type="checkbox"/>	<input type="checkbox"/>
		Note:		
6	Radio navigation/ instrument charts	<ul style="list-style-type: none"> • Presence of instrument approach charts (available/within reach/ up-to-date) • Presence of en-route charts (available/within reach/up-to-date) • Route covering • FMS/GPS database validity 	<input type="checkbox"/>	<input type="checkbox"/>
		Note:		
7	Minimum equipment list	<ul style="list-style-type: none"> • Presence of instrument approach charts (available/w within reach/ up-to-date) • Presence of en-route charts (available/within reach/up-to-date) • Route covering • FMS/GPS database validity 	<input type="checkbox"/>	<input type="checkbox"/>
		Note:		
8	Certificate of registration	<ul style="list-style-type: none"> • On-board • Accuracy (Reg. mark, A/C type and S/N) • Format • English translation when needed • Identification plate (S/N) 	<input type="checkbox"/>	<input type="checkbox"/>
		Note:		

9	Noise certificate	<ul style="list-style-type: none"> On-board Approval (state of registry) 	<input type="checkbox"/>	<input type="checkbox"/>
		Note:		
10	AOC or equivalent	<ul style="list-style-type: none"> Accuracy Content (operator identification, validity, date of issue, A/C type, OPS SPECS) EASA TCO authorisation (if applicable) 	<input type="checkbox"/>	<input type="checkbox"/>
		Note:		
11	Radio licence	<ul style="list-style-type: none"> On-board Accuracy with installed equipment 	<input type="checkbox"/>	<input type="checkbox"/>
		Note:		
12	Certificate of airworthiness (C of A)	<ul style="list-style-type: none"> On-board (original or certified true copy) Accuracy Validity 	<input type="checkbox"/>	<input type="checkbox"/>
		Note:		
Flight data				
13	Flight preparation	<ul style="list-style-type: none"> Operational flight plan on board Proper filling Signed by pilot-in-command/commander (and where applicable, Dispatch) Fuel calculation Fuel monitoring/management NOTAMs Updated meteorological information Letter Y in flight plan 	<input type="checkbox"/>	<input type="checkbox"/>
		Note:		
14	Mass and balance calculation	<ul style="list-style-type: none"> On-board Accuracy (calculations/ limits) Pilots acceptance Load and trim sheet/ actual load distribution 	<input type="checkbox"/>	<input type="checkbox"/>
		Note:		
Safety equipment				
15	Hand fire extinguishers	<ul style="list-style-type: none"> On-board Condition/pressure indicator Mounting (secured) Expiry date (if any) Access Sufficient number 	<input type="checkbox"/>	<input type="checkbox"/>
		Note:		
16	Life jackets/flotation devices	<ul style="list-style-type: none"> On-board Access/within reach Condition 	<input type="checkbox"/>	<input type="checkbox"/>

		<ul style="list-style-type: none"> • Expiry date (where applicable) • Sufficient number 		
		Note:		
17	Harness	<ul style="list-style-type: none"> • On-board (no seatbelt) • Condition • Sufficient number (one for each crew member) 	<input type="checkbox"/>	<input type="checkbox"/>
		Note:		
18	Oxygen equipment	<ul style="list-style-type: none"> • On-board • Condition • Cylinder pressure (minimum acc. to operations manual) • Ask crew to perform the operational function check of combined oxygen and communication system • Follow practice of the flight crew 	<input type="checkbox"/>	<input type="checkbox"/>
		Note:		
19	Independent Portable light	<ul style="list-style-type: none"> • On-board • Appropriate quantities • Condition • Serviceability • Access/within reach • The need for an independent portable light (departure or arrival at night time) 	<input type="checkbox"/>	<input type="checkbox"/>
		Note:		

Flight crew				
20	Flight crew licence/composition	<ul style="list-style-type: none"> On-board Form/content/English translation when needed Validity Ratings (appropriate type) (pilot-in-command (PIC)/ATPL) Pilots' age Possible difference with ICAO Annex 1 (concerning the age of pilots) In case of validation (all documents needed) Medical assessment/ check interval Spare eye glasses if applicable Minimum flight crew requirements 	<input type="checkbox"/>	<input type="checkbox"/>
		Note:		
Journey log book / Technical log or equivalent				
21	Journey log book or equivalent	<ul style="list-style-type: none"> On-board Content Filling (carefully and properly) 	<input type="checkbox"/>	<input type="checkbox"/>
		Note:		
22	Maintenance release	<ul style="list-style-type: none"> Validity When need of maintenance, technical log has been complied with When ETOPS, requirement are met Signed off Verify that maintenance release has not expired Ex-Soviet built A/C 	<input type="checkbox"/>	<input type="checkbox"/>
		Note:		
23	Defect notification and rectification	<ul style="list-style-type: none"> Number of deferred defects All defects been notified Defect deferrals include time limits and comply with the stated time limits All the defects are notified Technical log markings (should be understandable by captain) Ex-Soviet built A/C 	<input type="checkbox"/>	<input type="checkbox"/>
		Note:		
24	Pre-flight inspection	<ul style="list-style-type: none"> Performed (inbound/ outbound flight) Signed off 	<input type="checkbox"/>	<input type="checkbox"/>
		Note:		
B	Cabin Safety			

1	General internal condition	<ul style="list-style-type: none"> • General condition • Possible loose carpets • Possible loose or damaged floor panels • Possible loose or damaged wall panels • Seats • Markings of unserviceable seats • Lavatories • Lavatory smoke detectors • Safety and survival equipment (shall be reliable, readily accessible and easily identified. Instructions for operation shall be clearly marked) • Possible obstacles to perform normal and abnormal duties 	<input type="checkbox"/>	<input type="checkbox"/>
		Note:		
2	Cabin crew stations and crew rest area	<ul style="list-style-type: none"> • Presence of cabin crew seats and compliance with the requirement • Sufficient number • Condition (seatbelt, harness) • Emergency equipment (independent portable light, fire extinguishers, portable breathing equipment ...) • Cabin preparation list 	<input type="checkbox"/>	<input type="checkbox"/>
		Note:		
3	First-aid kit/ emergency medical kit	<ul style="list-style-type: none"> • On-board • Condition • Expiry date • Location (as indicated) • Identification • Adequacy • Access • Operating instructions (clear) 	<input type="checkbox"/>	<input type="checkbox"/>
		Note:		
4	Hand fire extinguishers	<ul style="list-style-type: none"> • On-board • Condition (pressure indicator) • Expiry date (if available) • Mounting and access • Number 	<input type="checkbox"/>	<input type="checkbox"/>
		Note:		
5	Life jackets/ flotation devices	<ul style="list-style-type: none"> • On-board • Easy access • Condition • Expiry dates as applicable • Sufficient number • Infant vest 	<input type="checkbox"/>	<input type="checkbox"/>
		Note:		

6	Seat belt and seat condition	<ul style="list-style-type: none"> • On-board • Sufficient number • Condition • Availability of extension belts • Cabin seats (verify the condition) • If unserviceable check U/S-tag. • Restraint bars 	<input type="checkbox"/>	<input type="checkbox"/>
		Note:		
7	Emergency exit, lightning and marking, independent portable light	<ul style="list-style-type: none"> • Emergency exits (condition) • Emergency exit signs/ presence (condition) • Operation instructions (markings and passenger emergency briefing cards) • Floor path markings (ask to switch on). Possible malfunction/MEL • Lighting • Independent Portable light and batteries (condition) • Sufficient number of Independent Portable light (night operations) • Availability on each cabin attendant’s station. 	<input type="checkbox"/>	<input type="checkbox"/>
		Note:		
8	Slides/life-rafts (as required), ELT	<ul style="list-style-type: none"> • Slides on-board • Condition • Expiry date • Sufficient number • Location and mounting • Bottle pressure gauge • ELT on board • ELT (condition and date) 	<input type="checkbox"/>	<input type="checkbox"/>
		Note:		
9	Oxygen supply (cabin crew and passengers)	<ul style="list-style-type: none"> • Presence • Sufficient quantity of masks (cabin crew and passengers) • Drop-out panels are free to fall • Passenger instructions (passenger emergency briefing cards) • Portable cylinder supply and medical oxygen, check pressure and mounting 	<input type="checkbox"/>	<input type="checkbox"/>
		Note:		
10	Safety instructions	<ul style="list-style-type: none"> • On-board • Tidiness • Accuracy/content (A/C type) • Sufficient numbers (passenger emergency briefing card for each passenger) • Cards for flight crew (check emergency equipment locations) 	<input type="checkbox"/>	<input type="checkbox"/>

		Note:		
11	Cabin crew members	<ul style="list-style-type: none"> • General overview of cabin crew (conditions) • The sufficient number of cabin crew (appropriate) • How the duty stations are manned • Follow practice of the cabin crew • When refuelling with passengers on-board check procedures 	<input type="checkbox"/>	<input type="checkbox"/>
		Note:		
12	Access to emergency exits	<ul style="list-style-type: none"> • Access areas • Possible obstacles for evacuation (foldable jump seat or seat backrest table) 	<input type="checkbox"/>	<input type="checkbox"/>
		Note:		
13	Stowage of passenger baggage	<ul style="list-style-type: none"> • Hand baggage storages in cabin • Size of hand baggage • Quantity of hand baggage • Weight of hand baggage • Placed under seat (restraint bar) 	<input type="checkbox"/>	<input type="checkbox"/>
		Note:		
14	Seat capacity	<ul style="list-style-type: none"> • Number of passengers/ permitted • Sufficient seat capacity 	<input type="checkbox"/>	<input type="checkbox"/>
		Note:		
C	Aircraft condition			
1	General external condition	<ul style="list-style-type: none"> • Radom (latches/painting) • Windshields • Wipers • Static ports/areas • AoA probes • Pitot tubes • TAT probe • Crew oxygen discharge indicator (if exist) • Ground power connection (condition) • Wings (general condition, ice/snow contamination) • Fairings • Leading edge (dents) • Winglets • Trailing edge/static dischargers • Look for hydraulic leaks • Look for fuel leak • Fuselage • Tail section/static dischargers • APU cooling air inlet • APU exhaust air/surge 	<input type="checkbox"/>	<input type="checkbox"/>

		<ul style="list-style-type: none"> • Look at APU area for leaks • Tail bumper (contact markings) • Maintenance and service panels (water / waste / hydraulic maintenance panels / refuel panels / cargo door control panel / RAT door) • Cabin windows • Exterior lights • Painting (condition) • Cleanliness • Markings/operational instructions and registration • Obvious repairs • Obvious damage 		
		Note:		
2	Doors and hatches	<ul style="list-style-type: none"> • Passenger doors (condition) • Emergency exits (condition) • Cargo doors (condition) • Avionics compartment doors (condition) • Accessory compartment doors (condition) • Operation instructions of all doors • Lubrications of all doors • Door seals • Handles 	<input type="checkbox"/>	<input type="checkbox"/>
		Note:		
3	Flight controls	<ul style="list-style-type: none"> • Ailerons (condition) • Slats/Krueger flaps/Notch flap (condition) • Spoiler panels (condition) • Flaps/track fairings (condition) • Rudder (condition) • Elevators (condition) • Stabiliser (condition) <p><i>Note! Check for leaks, flap drooping, wearing, corrosion, disbonding, dents, loose fittings and obvious damages.</i></p>	<input type="checkbox"/>	<input type="checkbox"/>
		Note:		
4	Wheels, tyres and brakes	<ul style="list-style-type: none"> • Wheels (assembly condition, bolts and paint markings) • Tires (condition and pressure). Check for cuts, groove cracks, worn out shoulders, blister, bulges, flat spots) • Worn tire areas (measure the tread depth) • If cuts measure depth • Brakes (condition, wearing pins) • Measure and familiarise length of the pin/check for the limits. 	<input type="checkbox"/>	<input type="checkbox"/>
		Note:		

5	Undercarriage	<ul style="list-style-type: none"> • Landing gear/hinges (general condition/leaks) • Struts • Locking mechanisms • Hydraulic (or pneumatic) lines (condition) • Strut pressure (visual check/piston length) • Lubrication • Electric lines and plugs. • Bonding • Cleanliness • FOD (foreign object damage) • Surface (plasma) and paintings • Check for corrosion • Placards and markings (nitrogen pressure table) • Dampers and bogie cylinders (check for leaks) • Landing gear strut doors • Use independent portable light and mirror 	<input type="checkbox"/>	<input type="checkbox"/>
		Note:		
6	Wheel well	<ul style="list-style-type: none"> • General condition (structures) • Possible corrosion • Cleanliness • Installations (wiring, piping, hoses, hydraulic containers and devices) • Check for leaks • Wheel well doors (hinges) • Check for maintenance safety pins 	<input type="checkbox"/>	<input type="checkbox"/>
		Note:		
7	Powerplant and pylon	<ul style="list-style-type: none"> • Air intake ring (general condition/inner skin and acoustic panels) • Engine cowlings (panels aligned, handles aligned, vortex generators/access doors) • Intake area fasteners • Sensors • Thrust reverses (ring and inner doors or thrust reverser doors) • Reverser duct inner skin and acoustic panels • Outlet guide vanes (from behind/reverser duct) • Exhaust barrel (inner and outer skin) • Drain mast/leaks • Pylons (sealants, panels, doors and blow-out-doors, possible leaks) 	<input type="checkbox"/>	<input type="checkbox"/>
		Note:		
8	Fan blades, propellers, rotors (main/tail)	<ul style="list-style-type: none"> • Fan blades: general condition (check for foreign object damage, cracks, nicks, cuts, corrosion and erosion) • Fan blade: <ul style="list-style-type: none"> ○ Leading edge ○ Mid-span shroud (no stacked) ○ Tip 	<input type="checkbox"/>	<input type="checkbox"/>

		<ul style="list-style-type: none"> ○ Contour surface ○ Root area ○ platform <p><i>Note! Wait until rotation stop! Use independent portable light and mirror for the backside of the blades.</i></p> <ul style="list-style-type: none"> ● Spinner (damages/bolts) ● Fan outlet vanes (thorough the fan) ● FOD (foreign object damage) ● Split fairing ● Blades (general condition) ● Tip and mid area (75 % from root) ● Check for nicks, dents, cracks, leakages etc. ● Hub/spinner ● Looseness of blades in hub 		
		Note:		
9	Obvious repairs	<ul style="list-style-type: none"> ● During the inspection of C-items notify unusual design and repairs obviously not carried out in accordance with the applicable AMM/SRM 	<input type="checkbox"/>	<input type="checkbox"/>
		Note:		
10	Obvious damages unrepaired	<ul style="list-style-type: none"> ● During the inspection of C-items notify unassessed and unrecorded damages and corrosion (lightning strike, bird strikes, FODs, etc.) ● Check damage charts 	<input type="checkbox"/>	<input type="checkbox"/>
		Note:		
11	Leakage	<ul style="list-style-type: none"> ● During the inspection of C-items notify all the leaks: ● Fuel leaks ● Hydraulic leaks ● Toilet liquid leaks ● When leak: measure the leak rate and check the leak rates from AMM etc. if it is allowable and within normal operation limits or not. ● Wear eye protection and use proper inspection gears for inspection 	<input type="checkbox"/>	<input type="checkbox"/>
		Note:		
D	Cargo			
1	General condition of cargo compartment	<ul style="list-style-type: none"> ● Cleanliness ● Lightning ● Fire protection/detection/ extinguishing systems and smoke detectors ● Floor panels ● Wall panels/markings ● Blow-out-panels ● Ceilings ● Wall and ceiling panel sealants ● Cargo nets/door nets ● Fire extinguishers 	<input type="checkbox"/>	<input type="checkbox"/>

		<ul style="list-style-type: none"> • Cargo roller and driving system and control panel 		
		Note:		
2	Dangerous goods	<ul style="list-style-type: none"> • Operations manual/ information required by ICAO Annex 18 • Technical Instructions (ICAO Doc. 9284-AN/905) are applied If dangerous goods on-board: <ul style="list-style-type: none"> • Pilots’ notification • Stowing of dangerous goods cargo • Packaging (condition, leaks, damage) • Labelling If leak or damage of dangerous goods cargo: <ul style="list-style-type: none"> • Condition of other cargo • Follow removal • Follow cleaning of contamination 	<input type="checkbox"/>	<input type="checkbox"/>
		Note:		
3	Secure stowage of cargo	<ul style="list-style-type: none"> • Load distribution (floor limits, pallets and containers/maximum gross weight) • Flight kit/spare wheel/ ladders (secured) • Cargo (secured) • Condition and presence of: <ul style="list-style-type: none"> • Lockers • Restraints • Pallets • Nets • Straps • Containers • Container locks on the floor • Heavy items securing inside containers 	<input type="checkbox"/>	<input type="checkbox"/>
		Note:	<input type="checkbox"/>	<input type="checkbox"/>
E	General			
1	General	Note:	<input type="checkbox"/>	<input type="checkbox"/>
Additional elements (O) observed/performed (P) during On the Job Training				
<i>(Please List)</i>				
Assessment				
- Was the inspection carried out in a satisfactory manner regarding:				

- preparation of the inspection	<input type="checkbox"/> Yes <input type="checkbox"/> No (provide further details below*)
- ramp inspection	<input type="checkbox"/> Yes <input type="checkbox"/> No (provide further details below*)
- proof of inspection	<input type="checkbox"/> Yes <input type="checkbox"/> No (provide further details below*)
- human factors elements	<input type="checkbox"/> Yes <input type="checkbox"/> No (provide further details below*)
Further training needed:	
Additional Remarks:*	
Signature of the trainee:	Signature of the senior ramp inspector:

GM1 ARO.RAMP.115(b)(2) Qualification of inspectors

PRIVILEGES OF EXPERIENCED INSPECTORS

- (a) The following example shows the typical privileges of an experienced commercial pilot licence/airline transport pilot licence (CPL/ATPL) holder and of an experienced aircraft maintenance engineer:

Example:

Typical inspection privileges of a CPL/ATPL holder could include the following inspection checklist items in Appendices III and IV of this section:

A items

B items

C items

D1/D3 items

Typical inspection privileges of an aircraft maintenance licence (AML) holder could include the following inspection checklist items:

A items except for A3, A4, A5, A6, A13, A14, A20

B items except for B11, B14

C items

D1 items

- (b) The competent authority may decide to enlarge the privileges of the inspector if the basic knowledge of the inspector has been satisfactorily enlarged by additional theoretical trainings and/or practical trainings. This may require the subsequent following of the relevant module of the ramp inspection training in order to obtain the necessary knowledge to exercise that new privilege. As an example: if an AML holder has acquired knowledge on the operational items of the 'A' section (flight crew compartment items) of the checklist (e.g. because he/she obtained his/her CPL), the privileges may be expanded. He/she should be required, however, to receive the theoretical, practical and on-the-job training on how to inspect those new items. Considering that the inspector is already qualified, the OJT could:

- (1) be performed in a classroom environment using various (representative) examples when no aircraft is required for the training. E.g.: normally the interaction with the flight crew is part of the OJT. However, if the inspector is privileged on other A-items on the checklist and

therefore familiar with interviewing the flight crew in the flight crew compartment, the OJT of inspection items A13 and A14 could be done in a classroom; or

- (2) be limited in terms of number of inspections depending on the number of new inspection items to be trained; the minimum number of OJT inspections, as described in AMC2-ARO.RAMP 115(b)(2) point (d)(1), does not apply since the number of 6 observer and 6 supervised inspections is aiming at a 50 % average coverage of all inspection items during these inspections. For the limited OJT, the number of inspections should be reasonable and should be determined by the senior inspector whereby the new items should be inspected at least 3 times as an observer and 3 times under supervision.

AMC1 ARO.RAMP.115(b)(2)(i) Qualification of ramp inspectors

SYLLABUS OF THEORETICAL KNOWLEDGE FOR RAMP INSPECTORS

INITIAL (THEORETICAL) TRAINING COURSE

- Module (GEN): General overview (legal)
- Module (A): Flight crew compartment inspection items
- Module (B): Cabin safety inspection items
- Module (C): Aircraft condition inspection items
- Module (D): Cargo inspection items

MODULE (GEN)	
a. Overview of the safety assessment of aircraft	
i. Introduction <ul style="list-style-type: none"> • The Ramp Inspection Programme Overview • Role and responsibilities of the Agency — Overview 	Objectives: <ol style="list-style-type: none"> 1. Trainees should know the background of the EU Ramp Inspection Programme 2. Trainees should be able to identify the main elements of the Programme 3. Trainees should understand the role of ramp inspections in the general safety oversight context
ii. The EU Ramp Inspection programme — ICAO basic references <ul style="list-style-type: none"> • ICAO convention • Annex 1 – Personnel Licensing • Annex 6 – Operations of Aircraft • Annex 8 – Airworthiness of Aircraft — Main features • Application by all participating States • Dissemination of inspection results • Bottom-up approach • Focused attention • Compliance with ICAO standards 	
iii. Principles of the EU Ramp Inspection Programme <ul style="list-style-type: none"> • EU Member State Role • States on safety assessment of foreign aircraft (SAFA) working arrangements with the Agency • Common procedures and common reporting format • The centralised data base –introduction • The legal obligation to inspect 	
iv. The European Commission <ul style="list-style-type: none"> • Role and responsibility • Legislative power 	
v. The European Aviation Safety Agency <ul style="list-style-type: none"> • Role and responsibilities 	

<ul style="list-style-type: none"> • The executive tasks • Collection of inspection reports • Maintenance of the centralised database • Analysis of relevant information • Reporting to European Commission and Member States • Advising the European Commission and Member States on follow-up actions • Developing training programmes and fostering the organisation and implementation of training courses and workshops <p>vi. EU and non-EU Member States</p> <ul style="list-style-type: none"> • Role and responsibilities • EU Member States • Non-EU States that have signed the Working Arrangement <p>vii. Eurocontrol</p> <ul style="list-style-type: none"> • Role and responsibilities <p>viii. The Air Safety Committee – (ASC)</p> <ul style="list-style-type: none"> • Role and responsibilities • Representation of EU Member States • Legislative advisory role <p>ix. The European SAFA Steering Expert Group – (ESSG)</p> <ul style="list-style-type: none"> • Role and responsibilities • Representation of EU Member States and non-EU Member States technical advisory role 	
--	--

b. The EU ramp inspection programme’s legal framework	
<p>i. Regulation (EC) No 2111/2005 <i>Scope and relevance</i></p> <p>ii. Regulation (EC) No 474/2006⁸ and subsequent amendments <i>Scope and relevance</i></p> <ul style="list-style-type: none"> • Regulation (EC) No 216/2008 – General overview • Article 10 – oversight and enforcement 	<p>Objectives:</p> <ol style="list-style-type: none"> 1. Trainees should fully understand the legal instruments of the Programme 2. Trainees should be able to identify the stakeholders and their responsibilities 3. Trainees should be capable to define the relationship between the Ramp Inspection Programme and the EU List of Banned air carriers

⁸ Commission Regulation (EC) No 474/2006 of 22 March 2006 establishing the Community list of air carriers which are subject to an operating ban within the Community referred to in Chapter II of Regulation (EC) No 2111/2005 of the European Parliament and of the Council (Text with EEA relevance), As last amended by Commission Regulation (EC) No 619/2009 of 13 July 2009, *OJ L 182, 15.7.2009, p. 4–24.*

c. The ICAO framework	
<p>i. International Requirements</p> <ul style="list-style-type: none"> • The Chicago Convention – general overview • The ICAO general overview • The Convention – key ramp inspection-related Articles • Article 11 – Applicability of air regulations • Article 12 – Rules of the air • Article 16 – Search of aircraft • Article 29 – Documents carried on aircraft • Article 30 – Aircraft radio equipment • Article 31 – Certificate of airworthiness • Article 32 – Licences of personnel • Article 33 – Recognition of certificates and licences • Article 37 – Adoption of international standards and recommended practices • Article 38 – Departures from international standards and procedures • Article 83 <i>bis</i> – Transfer of certain functions and duties <p>ii. Ramp inspection (RI) and ICAO — Annex 7 (Aircraft Nationality and Registration Marks) – Overview</p> <ul style="list-style-type: none"> • The Certificate of Registration • Example of Certificate of Registration • The identification plate <p>iii. RI and ICAO — Annex 8 (Airworthiness of Aircraft) – Overview</p> <ul style="list-style-type: none"> • Validity of the Certificate of Airworthiness • Standard form of Certificate of Airworthiness • Emergency exits, markings and lights • Safety and survival equipment <p>iv. RI and ICAO — Annex 1 (Personnel Licensing) – Overview</p> <ul style="list-style-type: none"> • General rules concerning licenses <p>v. RI and ICAO — Annex 6 (Operation of Aircraft) — Overview</p> <ul style="list-style-type: none"> • Part I, International commercial air transport aeroplanes • Part II, International general aviation aeroplanes • Part III, International operations helicopter <p>vi. RI and ICAO — Annex 16 (Environmental Protection) – Overview</p> <ul style="list-style-type: none"> • Noise Certificate (applicability to SAFA programme) <p>RI & ICAO — Annex 18 (The Safe Transport of Dangerous Goods by Air)</p> <ul style="list-style-type: none"> • Overview • Dangerous goods Technical Instructions for the safe transport of dangerous goods by air (Doc 9284) <p>RI & ICAO Doc 7030 (Regional Supplementary procedures)</p> <ul style="list-style-type: none"> • Overview • Applicability 	<p>Objectives:</p> <ol style="list-style-type: none"> 1. Trainees should be able to outline ICAO’s role and responsibilities within the international civil aviation context. 2. Trainees should understand the obligations of the signatory States. 3. Trainees should understand the direct relationship between ICAO standards and ramp inspection.
d. Safety assessment technical aspects overview	
<p>i. Preparation of the inspection</p> <p>ii. Subjects of the inspection:</p> <ul style="list-style-type: none"> • Aircraft used by third country operators or used by operators under the regulatory oversight of another Member State. • Technical considerations • Experience/feedback from previous checks 	

- ‘Intelligence’ (centralised database, ATC, passenger complaints, etc.)
 - Prioritisation
- iii. Elements to be inspected:
- In principle, all RI checklist items; but:
 - Other considerations for a limited inspection:
 - Time available (stop duration, slot, no unreasonable delay)
 - Inspector privileges
 - Areas of concern (based upon previous checks and/or centralised database)
 - Context (recent/old aircraft, new airline, new type of aircraft)
 - Intelligence information
- iv. Planning the inspection:
- Efficient use of the time available
 - Considerations for inspections on arrival or departure
 - Any day in a week, any time in a day
- v. Short transit times:
- Walk around check during off boarding
 - Segmented inspections
- vi. Toolkit for the RI inspector:
- Inspector’s documentation (RI procedures, regulations, updated reference material, etc.)
 - Inspector’s tools (vest, Independent Portable light, camera, telephone, protective personal equipment, etc.)
 - Inspector’s identification (authority ID, airport badge)
 - Airline documentation available
- Vii. Teamwork:
- Preferably two inspectors covering all fields of expertise
 - Briefing on task allocation
- viii. The ramp inspection checklist:
- Aspects to be covered by the ramp inspection
 - The ramp inspection checklist (format/structure and overview of contents)
- ix. Starting the Inspection:
- Introduction to the crew (flight crew/technical staff/airline representative/translator)
 - Determination of available inspection time
 - Explain that any operator is subject to inspections (ramp inspection principle)
- x. Code of conduct:
- Human factor principle (inspection = intrusion)
 - Cooperation with the crew
 - Time efficiency
 - Collection of evidence
- xi. Categorisation of findings:
- Definition of finding: Deviation from the standards
 - Category 3 finding with major influence on safety
 - Category 2 finding with significant influence on safety
 - Category 1 finding with minor influence on safety
- xii. Follow-up actions:
- Relationship between finding and action
 - Class 1 action
 - Class 2 action
 - Class 3 actions
- xiii. Concluding the inspection:

<ul style="list-style-type: none"> • Debriefing of inspection results • Delivery of proof of inspection to the pilot-in-command/commander/airline representative/sub-contractors 	
<p>e. Ramp inspection centralised database — Hands-on training</p>	
<ul style="list-style-type: none"> • Purpose of the database • The database as inspectors’ tool • RI database – input • RI database – output • RI database – search • Focused inspection module • Follow-up actions: operator logging • Database analytical tools and reports 	<p>Objectives:</p> <ol style="list-style-type: none"> 1. Trainees should have the relevant knowledge to input and retrieve data from the RI centralised database. 2. Trainees should know the analysis process and its deliverables. 3. Trainees should understand the analysis dependability on the accuracy of the inspection reports.

<p>2. MODULE (A)</p>	
<p>a. Ramp inspection items (A)</p>	
<p>A1 General condition (flight crew compartment)</p> <ul style="list-style-type: none"> • Circuit breakers (C/B) (inappropriately pulled/popped) • Secure stowage of interior equipment (incl. baggage) • Crew seats (manual or electrical) • Security/reinforced flight crew compartment door • General condition of flight crew compartment <p>A2 Emergency Exit (flight crew compartment)</p> <ul style="list-style-type: none"> • Access (easy/no blockings) • Escape ropes (secured) • Emergency exits (flight crew compartment) <p>A3 Equipment</p> <ul style="list-style-type: none"> • Awareness of different design philosophies of A/C systems (BITE, message displays/status) • Proper functioning (system test) <p>GPWS — TAWS</p> <ul style="list-style-type: none"> • General (basic principles) • Forward looking terrain avoidance function (7-channel SRPBZ ICAO compliant) • Presence of the equipment • Validity of GPWS database • System test — passed • CIS built A/C systems (SSOS, SPPZ and SRPBZ) <p>ACAS/TCAS II</p> <ul style="list-style-type: none"> • General (applicability and principles) • Mode S transponder and ACAS II (general) • System test <p>8.33 kHz radio channel spacing</p> <ul style="list-style-type: none"> • Selection of an 8.33 kHz channel • Presence of 6 or 5 digits (132.055 or 32.055) • Letter Y in field 10 of the flight plan <p>RNAV — BRNAV — PRNAV</p> <ul style="list-style-type: none"> • General (applicability and principles) 	<p>Objectives:</p> <p>Trainees should possess the relevant knowledge enabling them to inspect each item.</p>

<ul style="list-style-type: none"> • Special authorisation • Required equipment • Flight planning and completion of the flight <p>RVSM</p> <ul style="list-style-type: none"> • General (applicability and principles) • Special authorisation • Required equipment • Flight planning and completion of the flight <p>MNPS</p> <ul style="list-style-type: none"> • General (applicability and principles) • Special authorisation • Required equipment • Flight planning and completion of the flight <p>A4 Manuals</p> <ul style="list-style-type: none"> • Operation manual (structure) • Aircraft flight manual (structure) • Competent Authority approval • Update status • Ex-Soviet-built aircraft Rukowodstwo or RLE • Electronic flight bag (EFB class 1, 2 and 3) • Content in relation to flight preparation <p>A5 Checklists</p> <ul style="list-style-type: none"> • Availability: within reach and update status • Compliance with operator procedures (normal, abnormal and emergency) • Appropriateness of checklist used (aircraft checklists) • A/C system integrated checklists • Ex-Soviet-built aircraft issues (pilot's checklist and flight engineer's checklist) <p>A6 Radio navigation/instrument charts</p> <ul style="list-style-type: none"> • Required charts (departure, en-route, destination and alternate): • within reach and update status • Validity of FMS database • Electronic maps and charts • The AIRAC Cycle <p>A7 Minimum equipment list (MEL)</p> <ul style="list-style-type: none"> • Availability: approval and update status • Content: MEL reflects installed equipment • Ex-Soviet-built aircraft: 'Rukowodstwo' content • Relationship MEL/Master MEL • CDL (configuration deviation list) <p>A8 Certificate of Registration</p> <ul style="list-style-type: none"> • Availability and accuracy • Original documents and certified copies acceptability • Presence of mandatory information on the certificate: • Identification plate (type — location) <p>A9 Noise certificate</p> <ul style="list-style-type: none"> • Availability (if applicable) • Multiple noise certification • Approval status 	
--	--

<p>A10 AOC or equivalent</p> <ul style="list-style-type: none"> • Availability (original or copy) and accuracy • Content in compliance with requirements/format • Content of operational specifications <p>A11 Radio (station) license</p> <ul style="list-style-type: none"> • Availability and accuracy • Original documents and certified copies acceptability <p>A12 Certificate of Airworthiness (C of A)</p> <ul style="list-style-type: none"> • Format of Certificate of Airworthiness • Original documents and certified copies acceptability • Presence, accuracy and validity <p>A13 Flight preparation</p> <ul style="list-style-type: none"> • Presence and accuracy of operational flight plan • Performance calculations • Proper fuel calculation and monitoring • Special considerations for ETOPS operations • Availability and update of meteorological information • Availability and update of NOTAMS <p>A14 Mass and balance calculation</p> <ul style="list-style-type: none"> • Availability and accuracy • Data available for a verification by crew <p>A15 Hand fire extinguishers</p> <ul style="list-style-type: none"> • Validity, access and locations • Mounting • Types <p>A16 Life-jackets/flotation devices</p> <ul style="list-style-type: none"> • Validity, access and locations • Applicability <p>A17 Harness</p> <ul style="list-style-type: none"> • Presence (and usage) • Availability for all flight crew members • Requirements for different crew positions • Conditions (wearing) <p>A18 Oxygen equipment</p> <ul style="list-style-type: none"> • Presence, access and condition • Oxygen cylinder pressure • Minimum required according to the operations manual (in case of low pressure) • Operational functional check of the combined oxygen and communication system (crew) <p>A19 Independent portable light</p> <ul style="list-style-type: none"> • Number of required independent portable light(s) (day/night) • Condition, serviceability and access <p>A20 Flight crew licences</p> <ul style="list-style-type: none"> • Validity of crew licences and appropriate ratings • Validation of foreign licences 	
--	--

<ul style="list-style-type: none"> • Validity of medical certificate • Special medical conditions (spare glasses, etc.) • Age limitations • Minimum crew requirements <p>A21 Journey Log book</p> <ul style="list-style-type: none"> • Content of journey log book (recommendation/roman numerals) • Examples of journey log books <p>A22 Maintenance Release</p> <ul style="list-style-type: none"> • Applicable requirements and duties of the PIC/ commander <p>A23 Defect notification and rectification (incl. technical log)</p> <ul style="list-style-type: none"> • Defects notification • Cross check with MEL • History of defects/notification (incl. hold item list) <p>A24 Pre-flight inspection</p> <ul style="list-style-type: none"> • Applicable requirements and duties of the PIC 	
---	--

MODULE (B)	
a. Ramp inspection items (b)	
<p>B1 General internal condition</p> <ul style="list-style-type: none"> • General condition • Safety and survival equipment • Design and construction <p>B2 Cabin Crew Stations and Crew Rest Area</p> <ul style="list-style-type: none"> • Cabin crew seats (number, material/fire resistant and condition, upright position/safety hazard) • Equipment <p>B3 First-aid kit/emergency medical kit</p> <ul style="list-style-type: none"> • Recommendation on contents (validity) • Locations of kits • Adequacy • Readily/access • Identifications/markings/seals <p>B4 Hand fire extinguishers</p> <ul style="list-style-type: none"> • Validity, access and locations • Mounting • Types <p>B5 Life-jackets/flotation devices</p> <ul style="list-style-type: none"> • Validity, access and locations • Applicability • Different models of jackets and/or flotation devices on-board • Instructions for passengers (written and demonstration) <p>B6 Seat belt and seat condition</p> <ul style="list-style-type: none"> • Seats and belts (material/condition/installation) • Portable light (cabin crew) • Instructions for passengers (written and demonstration) 	<p>Objectives: Trainees should possess the relevant knowledge enabling them to inspect each item.</p>

<ul style="list-style-type: none"> • Opening assistance systems <p>B7 Emergency exit, lighting and marking, independent portable light</p> <ul style="list-style-type: none"> • Evacuation signs • Lighting and marking (passenger compartment) • Independent Portable light <p>B8 Slides/life-rafts/ELTs</p> <ul style="list-style-type: none"> • Slides/rafts general (locations, types) • Serviceability — pressure gauge/green band • Instructions for passengers (written and demonstration) • Emergency locator transmitter (ELT) (general/types/location) <p>B9 Oxygen supply (cabin crew and passengers)</p> <ul style="list-style-type: none"> • Oxygen supply: cylinders and generators • Serviceability — pressure gauge/green band • Models/A/C types • Drop-out panels/storage of masks <p>B10 Safety instructions</p> <ul style="list-style-type: none"> • Availability and accuracy <p>B11 Cabin crew members</p> <ul style="list-style-type: none"> • Appropriate number of cabin crew (A/C type) • Refuelling with passengers on-board (crew positions) <p>B12 Access to emergency exits</p> <ul style="list-style-type: none"> • Number and location of exits • Different models and sizes (A/C type) • Obstructions • Instructions for passengers (written and demonstration) <p>B13 Stowage of passenger baggage's (cabin luggage)</p> <ul style="list-style-type: none"> • Proper storage (size, weight and number) • Safety risks <p>B14 Seat capacity</p> <ul style="list-style-type: none"> • Numbers of seats (A/C type) • Max number of passengers (A/C type) 	
--	--

MODULE (C)	
RAMP INSPECTION ITEMS (C)	
<p>C1 General External Condition</p> <ul style="list-style-type: none"> • Corrosion (different corrosion types) 	<p>Objectives: Trainees should possess the relevant knowledge enabling them to inspect each item.</p>

<ul style="list-style-type: none"> • Cleanliness and contamination (fuselage and wings) • Windows and windshields (delamination) • Exterior lights (landing lights, NAV-lights, strobes, beacon, etc.) • Markings • De-icing requirements <p>C2 Doors and hatches</p> <ul style="list-style-type: none"> • Door types (normal — emergency — cargo doors) • Markings and placards of doors • Operating instructions of doors • Condition and possible damages <p>C3 Flight controls</p> <ul style="list-style-type: none"> • Condition and possible damages, corrosion and loose parts • Rotor head condition • Leakage <p>C4 Wheels, tyres and brakes</p> <ul style="list-style-type: none"> • Tyre pressure (cockpit indications/wheel integrated gauge) • Brake condition • Condition and possible damages, leaking and loose parts <p>C5 Undercarriage</p> <ul style="list-style-type: none"> • Condition and possible damages, corrosion and loose parts • Strut (and tilt cylinder) pressure <p>C6 Wheel well</p> <ul style="list-style-type: none"> • Condition and possible damages, corrosion, leaks and loose parts <p>C7 Powerplant and pylon</p> <ul style="list-style-type: none"> • Cowlings, cowling doors and blow-out doors • Condition and possible damages, corrosion, leaks and loose parts • Pylon, pylon doors, blow-out panels and missing rivets • Condition and possible damages, corrosion, leaks and loose parts • Reversers' condition <p>C8 Fan blades, propellers, rotors</p> <ul style="list-style-type: none"> • Types of fan blades/propellers/rotors • Foreign object damage (FOD), (dents, nicks, blade bending) • De-icing (boots and heating elements) <p>C9 Obvious repairs</p> <ul style="list-style-type: none"> • Obvious repairs/maintenance release, technical log <p>C1.0 Obvious unprepared damage</p> <ul style="list-style-type: none"> • Damages/missing maintenance release, technical log • Assessment of damage 	
---	--

<p>C11 Leakage</p> <ul style="list-style-type: none"> • Obvious leakage, technical log • Types and assessment of leakage • Toilet leaks/blue ice, etc. 	
--	--

MODULE (D)	
Ramp inspections items (D)	
<p>D1 General condition of cargo compartment</p> <ul style="list-style-type: none"> • Structures, wall panels, wall sealing • Fire detection & extinguishing systems • Blow-out panels • 9G-net • Containers • Loading instructions/door instructions • Damage <p>D2 Dangerous goods</p> <ul style="list-style-type: none"> • Notification to the pilot-in-command/commander • Segregation and accessibility • Packaging and labelling • Limitations/restrictions (cargo aircraft) goods) <p>D3 Cargo stowage</p> <ul style="list-style-type: none"> • Loading instructions (placards, wall markings) • Flight kit (secured) • Pallets, nets, straps, containers (secured) • Loading limitations (weight, size and height) <p>E1 General</p> <ul style="list-style-type: none"> • All the general items that may have a direct relation with the safety of the aircraft or its occupants 	<p>Objectives:</p> <p>Trainees should possess the relevant knowledge enabling them to inspect each item.</p>

AMC2 ARO.RAMP.115(b)(2)(i) Qualification of ramp inspectors

SYLLABUS OF PRACTICAL TRAINING FOR RAMP INSPECTORS — INITIAL (PRACTICAL) TRAINING COURSE

- Module (A): Flight crew compartment inspection items
- Module (B): Cabin safety inspection items
- Module (C): Aircraft condition inspection items
- Module (D): Cargo inspection items

MODULE A (Flight crew compartment inspection items)	
<p>A1 General condition (of flight crew compartment)</p> <ul style="list-style-type: none"> • Security/reinforced door (how to recognise) • Reinforced flight crew compartment door installations/locking functions (with a real example) • C/Bs/circuit breakers (recognise pulled/popped) • Crew seats/serviceability (functions of seats/manual — electrical) • Examples of storage of flight cases and crew luggage (possible safety hazards) • Check cleanness of flight crew compartment <p>A2 Emergency exit (flight crew compartment)</p> <ul style="list-style-type: none"> • Recognise easy access (no blockings) • Escape ropes (check if secured) <p>A3 Equipment</p> <p>GPWS-TAWS:</p> <ul style="list-style-type: none"> • GPWS, locate instruments in cockpit • Aural warning test demonstrating: Sounds/display patterns • Recognise CIS-built A/C systems (if possible): SSOS — SPPZ — SRPBZ <p>ACAS/TCAS II</p> <ul style="list-style-type: none"> • Locate instruments in cockpit • Mode S transponder and ACAS II (locate and check the model) • System warning test/indications <p>8.33 kHz radio channel spacing</p> <ul style="list-style-type: none"> • Indication in the flight plan (examples) • How to check real channel spacing during the inspection (performed with real radios or approved training devices) <p>A4 Manuals (flight manuals only)</p> <ul style="list-style-type: none"> • Operations manual: (content/handling exercise) • Aircraft flight manual (examples) • Electronic manuals (lap-tops)/integrated systems <p>A5 Checklists</p> <ul style="list-style-type: none"> • Check validity normal-, abnormal-, emergency checklists and ‘quick reference handbook’ • Meaning of ‘available’/within reach (case study/ examples) • A/C sys integrated checklists (demonstration of system) • Ex-Soviet-built A/C checklists (recognise/examples) <p>A6 Radio navigation/instrument charts</p> <ul style="list-style-type: none"> • Check the covering of charts • En-route and instruments approach charts (view examples) • Locations in the flight crew compartment • Electronic maps and charts (examples) • Check updating markings of the charts and folders. • FMS navigation data-base (check the ‘INIT’ page for validity) <p>A7 Minimum equipment list (MEL)</p> <ul style="list-style-type: none"> • Check the deferred defects are in accordance with the MEL instructions • Inspect MEL according the current MMEL • Approval (check) • ‘Rukowodstwo’ (examples) 	<p>Objectives:</p> <p>Trainees should be able to use their technical knowledge and ramp inspection techniques in a satisfactory manner during the subsequent on-the-job training</p>

<p>A8 Certificate of Registration (CoR)</p> <ul style="list-style-type: none"> • Content and accuracy of the Certificate of Registration (various examples/check) • Requirements of certified true copy (examples of copies) • Common location in the A/C • Identification plate/show various locations in A/C <p>A9 Noise certificate</p> <ul style="list-style-type: none"> • Format of the noise certificate • Content of noise certificate/approval/(check) <p>A10 Air Operator Certificate (AOC) or equivalent</p> <ul style="list-style-type: none"> • Format of the air operator certificate • Content and accuracy of AOC/approval (check compliance with the requirement) • Show location (A/C documents or door) <p>A11 Radio (station) licence</p> <ul style="list-style-type: none"> • Format of the radio station licence (examples) • Show location (a/c documents or door) <p>A12 Certificate of Airworthiness (C of A)</p> <ul style="list-style-type: none"> • Check certificate and content (recognise standard form) • Accuracy and validity (check) • Show location (A/C documents or door) <p>A13 Flight preparation</p> <ul style="list-style-type: none"> • Check operational flight plan, proper filling and relevant documents • Proper fuel calculation and monitoring (demonstration of various examples) • NOTAMs/check validity (examples) • Weather information/available and within reach (demonstrate updated reports/examples) <p>A14 Mass and balance calculation</p> <ul style="list-style-type: none"> • Check examples of different type weight and balance sheets/A/C types (manual and computerised) <p>A15 Hand fire extinguishers</p> <ul style="list-style-type: none"> • Locations/access (flight crew compartment visit) • Condition and pressure gauge • Familiarise with different date markings (inspection date or expiry date) • Mountings (review examples) • Types (review examples) <p>A16 Life-jackets/flotation devices</p> <ul style="list-style-type: none"> • Locations • Familiarise with date markings • Extra raft location in flight crew compartment (installation, pressure gauge) <p>A17 Harness</p> <ul style="list-style-type: none"> • Worn out (examples) • Locks (common problems) <p>A18 Oxygen equipment</p> <ul style="list-style-type: none"> • Storage of masks (Quick Donning/Balloon) • Pressure gauge (check green band) • Radio boom — mask check <p>A19 Independent Portable light</p> <ul style="list-style-type: none"> • Locations • Operational check 	
--	--

<p>A20 Flight crew licences</p> <ul style="list-style-type: none"> • Licenses of personnel: <ul style="list-style-type: none"> — endorsement of certificates and licenses — validity of endorsed certificates and licenses — language proficiency — medical certificate (spare glasses, etc.) — validity of licences • Aeroplane flight crew: <ul style="list-style-type: none"> — composition of the flight crew — age limitations <p>A21 Journey logbook</p> <ul style="list-style-type: none"> • Content of journey log book (check markings and comply with the requirement) • Responsibility of signing log book (example) <p>A22 Maintenance release</p> <ul style="list-style-type: none"> • Aeroplane maintenance (maintenance record) • Maintenance release, general (checkmark or sign) • Relevant release for service (examples) <p>A23 Defect notification and rectification (incl. Tech Log)</p> <ul style="list-style-type: none"> • Open defects • History of defects (including hold item list) <p>A24 Pre-flight inspection</p> <ul style="list-style-type: none"> • Pre-flight inspection sheet and journey log book (presence and signed off) 	
--	--

MODULE B (Cabin Safety)	
<p>B1 General internal condition (cabin)</p> <ul style="list-style-type: none"> • Safety and survival equipment (cabin visit for the locations) • Design and construction (familiarise with different type cabins) • Recognise loose carpet and damaged floor panel • System design features: <ul style="list-style-type: none"> — recognise right materials (<i>Cabin visit</i>) — lavatory smoke detection system/<i>Cabin visit for the locations</i> — built-in fire extinguisher system for each receptacle intended for disposal of towels, paper or waste (how to check extinguishers)/<i>Cabin visit for the locations</i> • Check that normal and abnormal duties by cabin crew may be performed without hindrance (<i>Guided tour in cabin for demonstration of duties</i>) <p>B2 Cabin crew stations and crew rest area</p> <ul style="list-style-type: none"> • Cabin crew seats (cabin visit for number, material and condition) • Cabin crew seats upright position (case study/ recognise safety hazard) • Familiarise with problems with belt wearing and fast locks • Familiarise with seat attachment to the floor or wall • Easy access to emergency equipment (cabin visit for locations and condition) <p>B3 First-aid kit/emergency medical kit</p> <ul style="list-style-type: none"> • Cabin visit for locations (readily/access) • Adequacy (how to determine) • Confirmation that contents match the relevant checklist • Identifications/markings/seals (examples) <p>B4 Hand fire extinguishers</p> <ul style="list-style-type: none"> • Cabin visit for locations (readily/access) 	<p>Objectives:</p> <p>Trainees should be able to use their technical knowledge and ramp inspection techniques in a satisfactory manner during the subsequent on-the-job training</p>

<ul style="list-style-type: none"> • Checking serviceability <p>B5 Life-jackets/flotation devices</p> <ul style="list-style-type: none"> • Different models of life- jackets and flotation devices • Instructions for passengers • Condition and serviceability <p>B6 Seat belt and seat condition</p> <ul style="list-style-type: none"> • Seat belt material/condition (examples) • Recognise common problems with fast locks • Recognise common problems with seat belt wearing • Installation of seat belts (hazard to block evacuation) • Extra belts (locations) • Passenger seats (number and condition) • Passenger seat materials/fire resistant (recognise right materials) • Seat attach to the cabin floor (how to check) <p>B7 Emergency exit, lighting and marking, independent portable light</p> <ul style="list-style-type: none"> • Lighting and marking (cabin visit for locations and condition) • Condition and serviceability of exits • Instructions for passengers • Availability, serviceability and easy access of independent Portable light <p>B8 Slides/life-rafts/ELT's</p> <ul style="list-style-type: none"> • Slides/rafts general (cabin visit for locations and condition) • Check pressure gauge and recognise green band • Recognise condition of slides and rafts and familiarise with expiry date markings • Emergency locator transmitter (ELT) (cabin visit for locations and condition) • Automatic fixed ELT (examples/how to recognise) • Automatic portable ELT (examples/how to recognise) • Automatic deployable ELT (examples/how to recognise) <p>B9 Oxygen supply (cabin crew and passengers)</p> <ul style="list-style-type: none"> • Check oxygen supply (cylinders and generators) (cabin visit for locations and condition) • Check the cylinder pressure gauge and recognise green band • Drop-out panels (cabin visit for locations and condition) • Storage of masks/serviceability <p>B10 Safety instructions</p> <ul style="list-style-type: none"> • The meaning of available (within reach) • The meaning of accuracy/A/C types (recognise difference in instructions) • Content of instructions <p>B11 Cabin crew members</p> <ul style="list-style-type: none"> • Appropriate number of cabin crew (how to check) • Refuelling with passengers on board (check cabin crew positions) • Cabin crew member's type training document (familiarise with different types) <p>B12 Access to emergency exits</p> <ul style="list-style-type: none"> • Number and location of exits • Different models and sizes (A/C type) • Instructions for passengers (written and demonstration) • Obstructions (requirement on the projected opening) <p>B13 Stowage of passenger baggage (cabin luggage)</p> <ul style="list-style-type: none"> • Recognise proper storage (size, weight and number) • Familiarise and recognise safety risks (case study) <p>B14 Seat capacity</p>	
--	--

<ul style="list-style-type: none"> • Max number of passengers according to the cabin configuration • Compare the numbers of passenger and the number of serviceable seats • Interrelation with other inspection items: maximum number of passengers influenced by: B6 (inoperative seat) and/or B7 (inoperative exit) 	
--	--

MODULE C (aircraft condition)	
<p>C1 General external condition</p> <ul style="list-style-type: none"> • Recognise presence of ice, snow and frost • Condition of paint (familiarise when loose of painting is problem) • Recognise legibility of aircraft’s markings (registration) • Corrosion (familiarise and recognise different corrosion types) • Cleanliness and contamination of fuselage and wings (familiarise and recognise) • Windshields (recognise delaminating) • Windows (recognise damages and problems) • Exterior lights (landing lights, NAV-lights, strobes, beacon, etc.) (check the condition) • Recognise marks of lightning strike <p>C2 Doors and hatches</p> <ul style="list-style-type: none"> • Familiarise with different door types/structures (aircraft visit for locations) • Cockpit indications of doors (flight crew compartment visit) • Familiarise with markings and placards of doors • Operating instructions of doors (recognise hazards if lack of markings) • Recognise normal condition and possible damages/loosing parts <p>C3 Flight controls</p> <ul style="list-style-type: none"> • Condition and possible damages, corrosion and loose parts • Recognise marks of lightning strike • Familiarise with static dischargers (recognise when missing) • Recognise possible defects and damages <p>C4 Wheels, tyres and brakes</p> <ul style="list-style-type: none"> • Familiarise with different tyre models • Familiarise with different brake assemblies • Familiarise with maintenance manual limits • Recognise brake wearing indicator ‘pin’ (examples/locations) • Recognise normal condition and possible damages, leaking and loose parts • Tyre wear/tyre pressure (check) <p>C5 Undercarriage</p> <ul style="list-style-type: none"> • Condition and possible damages, corrosion and loose parts • Proper strut (and tilt cylinder pressure) • Lubrication (recognise signs of lubrication) • Familiarise with marking placards • Recognise bonding wires • Possible defects and damages <p>C6 Wheel well</p> <ul style="list-style-type: none"> • Condition and possible damages, corrosion and loose parts • Lubrication (recognise signs of lubrication) • Familiarise with marking placards • Recognise bonding wires 	<p>Objectives: Trainees should be able to use their technical knowledge and ramp inspection techniques in a satisfactory manner during the subsequent on-the-job training</p>

<ul style="list-style-type: none"> • Possible defects and damages <p>C7 Powerplant and pylon</p> <ul style="list-style-type: none"> • Powerplants (type of engines) • Cowlings, cowling doors and blow-out doors • Leaks (hydraulic, fuel, oil) • Condition and possible damages, corrosion, leaks and loose parts • Recognise engine sensors (condition) • Possible defects and damages • Pylon (types of pylons) — Recognise pylon doors, panels and blow-out panels and loose rivets — bolts • Reverser's condition (broken hinges and proper closure) <p>C8 Fan blades, propellers, rotors</p> <ul style="list-style-type: none"> • Typical foreign object damages (FOD), (examples of dents, nicks and blade bending) • Recognise looseness of blades in hub • Possible defects and damages (familiarise with procedures related to compliance with engine maintenance manual) • Check de-icing boots <p>C9 Obvious repairs</p> <ul style="list-style-type: none"> • Recognise obvious repairs (examples) • Maintenance release/technical log <p>C10 Obvious unrepaired damage</p> <ul style="list-style-type: none"> • Recognise obvious damages (examples) • Damages/maintenance release/technical log • Recognise assessment of damage (examples) <p>C11 Leakage</p> <ul style="list-style-type: none"> • Fluid leaks outside of limits (examples fuel, hydraulic, oil) • Obvious leak: check the maintenance release, technical log • Recognise toilet leaks (blue ice examples) • Recognise de-icing fluids on the A/C (aircraft visit for locations) 	
<p>MODULE D (Cargo)</p>	
<p>D1 General condition of cargo compartment</p> <ul style="list-style-type: none"> • Cargo compartment (aircraft visit for locations) • Check wall panels • Recognise wall sealing • Familiarise with A/C systems in cargo compartment: <ul style="list-style-type: none"> — fire containment, detection and extinguishing systems — ventilation — heating — loading systems (rollers) — lighting • Recognise blow-out panels • Familiarise with 9G-net • Cargo restraining devices • Check cargo door sealing for ETOPS • Containers • Loading instructions/door instructions • Damages in cargo compartment • Recognise obvious repairs in cargo compartment <p>D2 Dangerous goods (DG)</p> <ul style="list-style-type: none"> • How to recognise the special authorisation to transport DG • Assessing the scope of the authorisation (different classes) 	

<ul style="list-style-type: none"> • Notification to Captain (NOTOC) format and content • Segregation and accessibility • Examples of packaging and labelling of DG • Identifying limitations and restrictions for certain (sub)classes of DG • Identification and removal of contamination with DG <p>D3 Secure cargo stowage</p> <ul style="list-style-type: none"> • Cargo bay (guided visit for locations) • Loading instructions (placards, wall markings/tidiness) • Familiarise with flight kit/spare wheel (secured) • Familiarise with pallets, nets, straps, containers (secured) • Recognising loading limits (weight and height) 	
---	--

AMC1 ARO.RAMP.115(b)(3) Qualification of ramp inspectors

RECURRENT TRAINING

- (a) Once qualified, ramp inspectors should undergo recurrent training in order to be kept up-to-date.
- (b) The competent authority should ensure that all ramp inspectors undergo recurrent training at least once every 3 years after being qualified as ramp inspectors or when deemed necessary by the competent authority or the Agency, e.g. after major changes in the inspection procedures. The Agency will inform the competent authority of such necessity and on the associated timeframe for implementation.
- (c) Recurrent training should be delivered by a competent authority or by an approved training organisation.
- (d) The recurrent training should cover at least the following elements:
 - (1) new regulatory and procedural developments;
 - (2) new operational practices;
 - (3) articulation review of other European processes and regulations (list of banned operators or aircraft pursuant to Regulation (EC) No 2111/2005, authorisation of third-country operators); using data collected through ramp inspections; and
 - (4) standardisation and harmonisation issues.
- (e) If a senior ramp inspector loses his/her qualification as a result of failure to undergo the recurrent training mentioned in paragraph (b) above, he/she should be re-qualified by the competent authority by providing him/her with the missing recurrent training.

AMC2 ARO.RAMP.115(b)(3) Qualification of ramp inspectors

RECENT EXPERIENCE REQUIREMENTS

- (a) The minimum number of inspections required for ramp inspectors to maintain their qualification should be conducted during any 12-month period after undergoing training, evenly spread during such intervals.
- (b) This number may be reduced by the number of inspections on aircraft operated by domestic operators if the inspector is also a qualified flight operations, ramp or airworthiness inspector of a competent authority and is regularly engaged in the oversight of such operators.
- (c) If the inspector has performed some ramp inspections but he/she loses his/her qualification as a result of not reaching the minimum number of inspections during any 12-month period after qualification, he/she may be re-qualified by the competent authority by performing a number of

inspections under the supervision of a senior ramp inspector. The number of supervised inspections should not be less than half the number of missed inspections according to the minimum requirement. All ramp inspections under supervision which are necessary for re-qualification should be performed within 90 calendar days.

- (d) If the inspector loses his/her qualification because he/she has not been engaged in performing inspections on aircraft for more than 12 months, he/she may be requalified by the competent authority only after successfully completing on-the-job-training as prescribed in AMC2 ARO.RAMP.115(b)(2) and any recurrent training required.
- (e) If the inspector loses his/her qualification because he/she has not been engaged in performing inspections on aircraft for more than 36 months, he/she should be fully requalified by successfully completing initial theoretical, practical and on-the-job training.
- (f) The competent authority should ensure that all ramp inspectors undergo recurrent training at least once every 3 years after being qualified as ramp inspectors and whenever deemed necessary by the Agency due to significant changes of the ramp inspection programme.

GM1 ARO.RAMP.115(c) Qualification of ramp inspectors

COMPETENT AUTHORITY'S TRAINING PROGRAMME

The competent authority should ensure that its training programmes are amended accordingly to reflect any recommendations arising from the standardisation audits conducted by the Agency in accordance with Regulation (EU) No 7628/2013⁹.

⁹ OJ L 179, 29.6.2013, p.46

GM2 ARO.RAMP.115(c) Qualification of ramp inspectors

CHECKLIST FOR THE EVALUATION OF A THIRD PARTY TRAINING ORGANISATION

CHECKLIST FOR THE VERIFICATION OF A THIRD PARTY TRAINING ORGANISATION

1. ORGANISATIONAL STRUCTURE					
No.	Description	Yes	No	Remarks	
1	Has a manager with corporate authority been appointed?				
2	Has the training provider contracted enough staff to develop and deliver the envisaged training?				
3	Is the development and delivery of training in accordance with the technical criteria required by the Agency?				
2. FACILITIES AND OFFICE ACCOMMODATION					
No.	Description	Yes	No	Remarks	
1	Does the size and structure of the available training facilities ensure adequate protection against weather elements?				
2	Does the size and structure of the available training facilities provide proper training activities?				
3	As alternate means of compliance has the training organisation a procedure containing the applicable criteria when selecting the training facilities to be used, and are these criteria in compliance with the technical requirements provided by the Agency?				
3. INSTRUCTIONAL EQUIPMENT					
No.	Description	Yes	No	Remarks	
1	Is the presentation equipment appropriate for the training to be delivered?				
2	Can the trainees easily read the presented material from any position in the classroom?				
3	As alternate means of compliance has the training organisation a procedure containing the applicable criteria when selecting the training facilities to be used, and are these criteria in compliance with the technical requirements provided by the Agency?				
4	Does the training organisation ensure that a suitable aircraft is available for practical training for an adequate period?				

4. TRAINING PROCEDURE					
No.	Description	Yes	No	Remarks	
1	Has the training provider established appropriate procedures to ensure proper training standards?				
2	Has the training provider established a system to control the training preparation and delivery process?				
3	Is the course material written in the English language and will the course be given in the English language?				
4	Has the training provider demonstrated how compliance with Agency's technical criteria is maintained current and kept in line with the training syllabi?				
5	Has the training provider developed a system to evaluate the effectiveness of training provided?				
6	Has the training provider developed a system to evaluate the effectiveness of the training based upon the feedback received?				
5. INSTRUCTORS – QUALIFICATION CRITERIA					
No.	Description	Yes	No	Remarks	
1	Does the training organisation have an instructors' recruitment procedure?				
2	Does the recruitment procedure contain applicable selection criteria which are in compliance with the technical requirements provided by the Agency?				
3	Do the instructors possess knowledge of the ramp inspection programmes?				
4	Do the instructors have the knowledge on training methods and techniques?				
5	Do the instructors delivering training on inspection items/practical training meet the eligibility and inspection experience requirements?				
6	Do the other instructors meet the working experience criteria?				
6. INSTRUCTORS – QUALIFICATION RECORDS					
No.	Description	Yes	No	Remarks	
1	Has the training organisation created and maintained an adequate instructors' qualification tracking system that ensures their continuous competence at all times?				
2	Are the criteria used for the maintenance of the				

		instructors' continuous competence in compliance with the technical requirements provided by the Agency?			
7. INSTRUCTORS – RECENT EXPERIENCE AND RECURRENT TRAINING					
No.	Description		Yes	No	Remarks
1	Do the instructors meet, if applicable, the requirements on recent experience?				
2	Do the instructors meet the requirements on recurrent training?				
8. RECORDS KEEPING SYSTEM					
No.	Description		Yes	No	Remarks
1	Has the training organisation put in place a records keeping system that ensures the appropriate collection, storage, protection, confidentiality of data related to training materials developed, associated updates, examinations of the trainees, etc.?				
9. QUALITY SYSTEM					
No.	Description		Yes	No	Remarks
1	Has the training organisation put in place a quality system that ensures adequate control of the training development, preparation, delivery process and records keeping?				
10. TRAINING MATERIAL					
No.	Description		Yes	No	Remarks
1	Are the overview items covered during the theoretical training?				
2	Is the legal framework covered during the theoretical training?				
3	Is the ICAO framework covered during the theoretical training?				
4	Is the EU framework covered during the theoretical training?				
5	Are the technical aspects covered during the theoretical training?				
6	Is the 'Hands-on' training of the Database covered during the theoretical training?				
7	Are all A inspection items covered during the theoretical training?				

	8	Are all A inspection items covered during the practical training?			
	9	Are all B inspection items covered during the theoretical training?			
	10	Are all B inspection items covered during the practical training?			
	11	Are all C inspection items covered during the theoretical training?			
	12	Are all C inspection items covered during the practical training?			
	13	Are all D and E inspection items covered during the theoretical training?			
	14	Are all D and E inspection items covered during the practical training?			
	15	Does the training organisation provide to all course participants a copy of the complete training course material and the relevant EU aviation legislation, as well as relevant examples of technical information?			
11. ADDITIONAL REMARKS					

GM3 ARO.RAMP.115(c) Qualification of ramp inspectors

CHECKLIST FOR THE EVALUATION OF RAMP INSPECTIONS TRAINING INSTRUCTORS

1 Qualification Criteria				
No.	DESCRIPTION	YES	NO	REMARKS
1	Do the instructors possess knowledge of the EU Ramp Inspection Programme?			
2	Do the instructors have the knowledge on training methods and techniques?			
3	Do the instructors delivering training on inspection items/practical training meet the eligibility and inspection experience requirements?			
4	Do the other instructors meet the working experience criteria?			
2 Qualification records				
No.	DESCRIPTION	YES	NO	REMARKS
1	Has the training organisation created and maintained proper records on their instructors?			
3 Recent experience and recurrent training				
No.	DESCRIPTION	YES	NO	REMARKS
1	Do the instructors meet, if applicable, the requirements on recent experience?			
2	Do the instructors meet the requirements on recurrent training?			
ADDITIONAL REMARKS				

ARO.RAMP.120 Approval of training organisations

- (a) The competent authority shall approve a training organisation, having its principal place of business in the territory of the respective Member State, when satisfied that the training organisation:
- (1) has nominated a head of training possessing sound managerial capability to ensure that the training provided is in compliance with the applicable requirements;
 - (2) has available training facilities and instructional equipment suitable for the type of training provided;
 - (3) provides training in accordance with the syllabi developed by the Agency in accordance with ARO.RAMP.115(d);
 - (4) uses qualified training instructors.
- (b) If so requested by the competent authority, the verification of compliance and continuous compliance with the requirements referred to in (a) shall be performed by the Agency.
- (c) The training organisation shall be approved to provide one or more of the following types of training:
- (1) initial theoretical training;
 - (2) initial practical training;
 - (3) recurrent training.

AMC1 ARO.RAMP.120 Approval of training organisations

OVERSIGHT OF APPROVED TRAINING ORGANISATION

- (a) When determining the oversight programme of ramp inspector training organisations, the competent authority should assess the risks related to the type of activity carried out by the training organisation and adapt the oversight to the level of risk identified and to the organisation's ability to effectively manage safety risks.
- (b) An oversight cycle not exceeding 24 months should be applied. The oversight planning cycle may be extended to a maximum of 48 months if the competent authority has established that during the previous 24 months the organisation has been able to effectively manage safety risks.

AMC1 ARO.RAMP.120(a) Approval of training organisations

APPROVAL OF A TRAINING ORGANISATION BY THE COMPETENT AUTHORITY

- (a) When evaluating the training organisation's capability to deliver training the competent authority should verify that the training organisation:
- (1) provides a detailed description of:
 - (i) the organisational structure;
 - (ii) the facilities and office accommodation;
 - (iii) instructional equipment;
 - (iv) instructor recruitment and maintenance of their continuing competence;
 - (v) record keeping system;
 - (vi) training course material development and its continuous update; and

(vii) additional means and methods used to fulfil its tasks,

The documents and information specified above may be included into an organisation manual.

- (2) ensures compliance with its own procedures on adequate control of the training development, preparation, delivery process and records keeping, as well as compliance with the legal requirements. The training organisation should evaluate the effectiveness of the training provided, based upon written feedbacks collected from course participants after each training delivery.
 - (3) conducts the training in English with the aim to train trainees in the jargon used during ramp inspections;
- (b) For the purpose of evaluating an organisation's capability, the competent authority should use checklists containing at least the elements listed in GM2 ARO.RAMP.115(c). These checklists should be part of the final evaluation report drawn up by the competent authority and be kept for a minimum of 5 years, in accordance with ARO.GEN.220(c).
- (c) The competent authority should issue the approval for an unlimited duration.

AMC1 ARO.RAMP.120(a)(1) Approval of training organisations

ORGANISATIONAL STRUCTURE

The competent authority should verify that the training organisation has appointed a head of training with corporate authority to ensure that the training organisation:

- (a) has a sufficient number and properly qualified instructors to develop, update and deliver the training courses referred to in ARO.RAMP.115(b)(2)(i);
- (b) makes use of adequate training facilities and properly equipped office accommodation;
- (c) has established training procedures in accordance with AMC4 ARO.RAMP.120(a);
- (d) delivers training developed in accordance with the syllabi developed by the Agency;
- (e) periodically evaluates the effectiveness of the training provided; and
- (f) makes available to the competent authority an annual review summarising the results of the feedback system together with the training organisation's corrective actions (if any).

AMC1 ARO.RAMP.120(a)(2) Approval of training organisations

FACILITIES, OFFICE ACCOMODATION AND INSTRUCTIONAL EQUIPMENT

- (a) The competent authority should verify that:
- (1) the size and structure of the training facilities and office accommodation ensures protection from the prevailing weather elements and proper development, record keeping and delivery of all planned training on any particular day;
 - (2) the accommodation is separated from other facilities and appropriate to provide training;
 - (3) a suitable aircraft is available for practical training for an adequate period;
 - (4) classrooms have appropriate presentation equipment ensuring that students can easily read presentation text/drawings/diagrams and figures from any position in the classroom. Where necessary, audio amplification should be available to assist instructors in verbal

communication. Internet access should also be available to enable instructors to use the online applications used in the EU Ramp Inspection programme.

- (b) If the training organisation does not possess its own training facilities, office accommodation and instructional equipment, the competent authority should verify the system put in place by the training organisation to ensure full access to and use of training facilities, office accommodation and instructional equipment in accordance with this paragraph.

AMC1 ARO.RAMP.120(a)(3) Approval of training organisations

TRAINING COURSE

To assess training courses and training course materials, the competent authority should:

- (a) request from the training organisation a compliance checklist cross-referencing the training course content and the relevant syllabus developed by the Agency;
- (b) verify that the content of the training courses to be delivered complies with the syllabi developed by the Agency, also by attending at least one initial theoretical and practical training course;
- (c) ensure that the training course is reflecting any recommendations arising from the standardisation audits conducted by the Agency in accordance with Regulation (EU) No 628/2013¹⁰;
- (d) verify that the training course material is accurate and up to date and has been developed for the type of training to be delivered (including course slides, reference documents, etc);
- (e) verify that the training organisation provides to all course participants a copy of the complete training course material and the relevant EU aviation legislation, as well as relevant examples of technical information.

AMC1 ARO.RAMP.120(a)(4) Approval of training organisations

TRAINING INSTRUCTORS

- (a) The competent authority should verify that the training organisation has a sufficient number of instructors with at least adequate:
- (1) Adequate general knowledge and experience
 - (2) knowledge of the EU Ramp Inspection programme;
 - (3) knowledge of training delivery techniques; and
 - (4) English language communication skills.
- (b) Instructors delivering training on inspection items and/or delivering practical training should:
- (1) have conducted at least 72 inspections in the previous 3 years as qualified ramp inspectors before being nominated as instructors;
 - (2) have conducted at least 12 inspections as qualified ramp inspectors in the previous 12 months prior to the date of the training delivery;
 - (3) deliver training only on those inspection items which they are entitled to inspect;

¹⁰ Commission Implementing Regulation (EU) No 628/2013 of 28 June 2013 on working methods of the European Aviation Safety Agency for conducting standardisation inspections and for monitoring the application of the rules of Regulation (EC) No 216/2008 of the European Parliament and of the Council and repealing Commission Regulation (EC) No 736/2006 OJ L 179, 29.6.2013, p.46.

- (c) Instructors delivering training on the regulatory framework for ramp inspections should have at least 3 years of experience as national coordinators such as referred to in GM1 ARO.RAMP.100(c), or as qualified senior ramp inspectors, or as an European aviation safety legislation expert;
- (d) All instructors should attend (or familiarise with the content of) a recurrent training workshop, organised by the Agency, at least once every 3 years or at the request of the Agency to update their knowledge of the EU Ramp Inspection Programme and to promote standardisation.
- (e) Regarding theoretical and practical training on D02 items, instructors on dangerous goods certified in accordance with ICAO Annex 18 Doc 9284 AN/905 should only be required to have adequate knowledge of training delivery methods and techniques, and English language communication skills.

AMC1 ARO.RAMP.120(b) Approval of training organisations

VERIFICATION OF THE TRAINING ORGANISATION'S COMPLIANCE AND CONTINUOUS COMPLIANCE BY THE AGENCY

- (a) When the competent authority requests the Agency to verify a training organisation's compliance or continuous compliance with the applicable requirements, the following should be taken into account:
 - (1) the request should be submitted to the Agency at least 90 days prior to the intended date of issuing the approval or to the intended date of ending the continuous compliance verification; and
 - (2) the training organisation should be notified that the verification of compliance will be performed by the Agency, and, therefore, full cooperation and unimpeded access to the organisation staff, documentation, records and facilities should be ensured.
- (b) Verification may include an on-site audit and/or unannounced inspection of the training organisation.
- (c) The Agency should provide the requesting competent authority with a report containing the results of the compliance verification as soon as the process is finalised, but no later than 10 days prior to the anticipated date of approval.
- (d) When the Agency identifies a non-compliance with the applicable requirements, it should:
 - (i) immediately inform the competent authority concerned of non-compliance and indicate the level of finding(s), providing all the supporting evidence available;
 - (ii) provide the training organisation concerned with all the necessary information on the identified non-compliance indicating that the certifying competent authority has been informed in order to take action.
- (e) The competent authority may approve that organisation, if the results of the Agency's report indicate that the training organisation meets the applicable requirements.
- (f) When verifying continuous compliance with the applicable requirements, the Agency may:
 - (1) request the training organisation to provide updated versions of information, evidences and documents related to the training.
 - (2) sample the training course material delivered during any training session to candidates or qualified ramp inspectors;
 - (3) use the results of the standardisation inspections.

ARO.RAMP.125 Conduct of ramp inspections

- (a) Ramp inspections shall be performed in a standardised manner using the form established in either Appendix III or Appendix IV.
- (b) When performing a ramp inspection, the inspector(s) shall make all possible efforts to avoid an unreasonable delay of the aircraft inspected.
- (c) On completion of the ramp inspection, the pilot-in-command or, in his/her absence, another member of the flight crew or a representative of the operator shall be informed of the ramp inspection's results using the form established in Appendix III.

AMC1 ARO.RAMP.125 Conduct of Ramp Inspections & ARO.RAMP.130 Categorisation of findings

INSPECTION INSTRUCTIONS ON THE CATEGORISATION OF FINDINGS

Inspectors should follow the inspection instructions on the categorisation of findings established by the Agency for inspections performed on aircraft used by third country operators (SAFA) and on aircraft used by operators under the regulatory oversight of another Member State (SACA).

GM1 ARO.RAMP.125(a) Conduct of ramp inspections

STANDARDISED PERFORMANCE OF RAMP INSPECTIONS

- (a) When preparing a ramp inspection, the following should be taken into account:
 - (1) Selection of the aircraft/operator to be inspected and gathering of general information about the aircraft and operator;
 - (2) Obtaining the last update of the operating schedule for the selected operator from the operator, airport authorities, or ground-handling agents. In general, operators submit operating schedules twice per year. However, there might be 'last-minute changes' to these schedules. Therefore, inspecting team members should ensure that they have the latest schedule update. The internet can be a valuable source of information, and most airports have a website displaying information on arrival and departure times of scheduled flights. Schedule information on special flights, such as cargo and unscheduled or private flights, may need to be specifically requested from airports.
 - (3) Distribution of the tasks between ramp inspectors involved, especially in the case of limited inspection time and/or size and complexity of the aircraft.
 - (4) Co-operation with security, ground, and all other officials involved in airport activities, to enable the inspecting team to reach the aircraft to be inspected. When officials from different organisations (i.e. customs, security, Dangerous Goods inspectorate) have to work in co-operation during the inspection, a procedure on co-operation might need to be developed at a national level. Since most Member States have different airport procedures for inspectors, there is no standardised method, but Member States should provide inspectors with the respective credentials in order to ensure an unrestricted and unimpeded access.
 - (5) Obtaining relevant flight information on targeted operators from EUROCONTROL by using the application form to request access to EUROCONTROL's Central Flow Management Unit (CFMU) system.
 - (6) As a general rule, ramp inspections should be performed by at least two inspectors. Inspections performed by solo inspectors should be limited to exceptional cases, such as last minute unavailability of a team member, very short time to prepare a spot inspection,

etc. The authority should provide inspectors with the necessary tools (e.g. flashlights, digital camera, mobile phone) and protective clothing suitable for environmental circumstances (e.g. fluorescent vests, ear protection, anti-static clothing).

- (7) Depending on the items to be inspected, a ramp inspection may be performed on landing or on departure of the aircraft. The remaining fuel and cargo area (overloading, restraining, segregation, etc.) are examples of items that could be checked on landing. Flight preparation and storage of baggage in the cabin could be checked on departure. An inspection after landing should not jeopardise the total resting time of the flight crew.
- (8) Any unnecessary contact with passengers should be avoided and the inspection should not interfere, as much as possible, with the normal boarding/de-boarding procedures. However, inspecting certain elements in the cabin may be justified, for example such as:
 - (i) proper stowage of cabin baggage under the seat;
 - (ii) excessive overweight in overhead luggage bins;
 - (iii) baggage in front of emergency exit;
 - (iv) infants/children over the minimum age determined by the State of operator should have their own seat;
 - (v) allocation of passengers in the cabin, compared to the loadsheet data;
 - (vi) sufficient number of seats;
 - (vii) observing the boarding process during normal operations and/or during refuelling in process;
 - (viii) attempting to establish the commercial nature of a flight which is suspected to be performed illegally.
- (9) When circumstances (time, manpower, etc.) prevent inspection of all checklist items, inspectors should try to inspect those elements which, according to the inspectors' preparation and experience, are likely to be more safety critical depending on the particularities of the inspected flight. For this purpose, the following should be taken into account:
 - (i) Certain elements are less safety critical, and should, therefore, be given lower priority (e.g. a noise certificate has far less impact on safety than incorrectly completed mass and balance documentation, or incorrect calculation).
 - (ii) Differences in aircraft configuration: whereas for a cargo configuration the securing of the cargo and the segregation of dangerous goods is important; for a passenger configuration, checking the refuelling procedures with passengers on board could have higher priority.
 - (iii) Previous ramp inspection results: if serious and/or recurrent findings were raised during previous inspections on e.g. the Minimum Equipment List (MEL), this might be more important than the flight preparation on which previously no non-compliances were found.
 - (iv) Type and age of the aircraft: some aircraft types are known to have issues with e.g. leakages or missing screws, therefore, the age of the aircraft should also be taken into consideration.
- (10) If deemed appropriate, the inspector could contact the operator's representative at the airport so that he or she can be present during the ramp inspection. Experience shows that

the operator's representative may be helpful in providing support, especially in facilitating communication with the crew or the operator's home base.

- (11) Inspecting authorities might consider informing operators and authorities about the EU Ramp Inspection programme and explain to them what is expected from them when an inspection is being performed.

GM2 ARO.RAMP.125(a) Conduct of ramp inspections

DEFICIENCIES UNDER THE CONTROL OF THE OPERATOR

Deficiencies under the control of operators in accordance with applicable requirements are not to be considered as non-compliance: e.g. if an aircraft diverted because of a technical defect is inspected upon arrival, such defect should not be considered as a non-compliance and no finding should be raised, as long as the defect is properly reported (e.g. through the Technical Log Book) and subsequently assessed.

AMC1 ARO.RAMP.125(b) Conduct of ramp inspections

GENERAL

- (a) Ramp inspections should be performed by inspectors possessing the necessary knowledge relevant to the area of inspection whereby technical, airworthiness and operational knowledge must be represented in case all items of the checklist are being verified. When a ramp inspection is performed by two or more inspectors, the main elements of the inspection — the visual inspection of the aircraft exterior, the inspection in the flight deck and the inspection of the passenger cabin and/or cargo compartments — may be divided among the inspectors, according to their privileges granted in accordance with ARO.RAMP.115.
- (b) The competent authority should put in place appropriate procedures to allow them unrestricted access to the aircraft to be inspected. In this respect ramp inspectors should possess adequate credentials.
- (c) Inspectors should identify themselves to the pilot-in-command/commander of the aircraft or, in his/her absence, to a member of the flight crew or to the most senior representative of the operator prior to commencing the on-board part of their ramp inspection. When it is not possible to inform any representative of the operator or when there is no such representative present in or near the aircraft, the general principle should be not to perform a ramp inspection. In special circumstances it may be decided to perform a ramp inspection but this should be limited to a visual check of the aircraft exterior.
- (d) The inspection should be as comprehensive as possible within the time and resources available. This means that if only a limited amount of time or resources is available, not all inspection items but a reduced number may be verified. According to the time and resources available for a ramp inspection, the items that are to be inspected should be selected accordingly in conformity with the objectives of the ramp inspection programme. Items not being inspected may be inspected during a next inspection.
- (e) Inspectors should show tact and diplomacy when performing a ramp inspection. A certain amount of inconvenience to flight and cabin crews, handling agents and other personnel involved in ground handling activities may arise but inspectors should try to reduce it to the minimum. Unnecessary contact with passengers should be avoided.
- (f) Ramp inspectors should not open any hatches, doors or panels themselves nor should they operate or interfere with any aircraft controls or equipment. When such actions are required for

the scope of the inspection, the ramp inspectors should request the assistance of the operator's personnel (flight crew, cabin crew, ground crew).

- (g) The items to be inspected should be selected from the ramp inspection checklist (see Appendices III and IV). The ramp inspection checklist contains a total of 54 items. Of these, 24 relate to operational requirements (A-items) to be checked on the flight crew compartment, 14 items address safety and cabin items (B-items), 12 items are concerning the aircraft condition (C-items) and three items (D-items) are related to the inspection of cargo (including dangerous goods) and the cargo compartment. In case of any general inspection items not addressed by the other items of the checklist, they may be administered by the E-item (General) of the checklist.
- (h) Items which have been inspected as well as any possible findings and observations will be recorded in the Ramp Inspections Report (see Appendices III and IV).
- (i) ARO.RAMP.125(c) requires that the operator is informed about the results of every ramp inspection by providing it with a copy of the Proof of Inspection (see Appendix III). A signed acknowledgement of receipt should be requested from the recipient and retained by the inspector. Refusal to sign by the recipient should be recorded in the document.

GM1 ARO.RAMP.125(b) Conduct of ramp inspections

UNREASONABLE DELAY

- (a) The inspector intending to conduct the ramp inspection should be able to start the inspection immediately. The inspector should ensure that the inspection can be carried out expeditiously. Delays related to the availability of the inspector or the necessary inspection documentation or similar avoidable reasons of delay caused by the inspector, which are not directly related to safety, should be avoided without exception.
- (b) The inspector should carefully consider that flight and cabin crew distraction during the flight preparation phase as this might be a significant safety hazard and should, therefore, be avoided as much as possible. In order to minimise distraction to the flight and cabin crew, the inspector should:
 - (1) try to be as precise and complete as possible when requesting aircraft documents from flight crew. This should result in a minimum of discussion time, thus allowing the flight crew to deal with their primary task of flight preparation;
 - (2) ask the senior cabin crew member to assign a crew member to assist them with their inspection tasks;
 - (3) inform cargo loading staff of possible hindrance due to inspection task in cargo compartment;
 - (4) give priority to staff directly involved in the flight preparation, when carrying out inspections on the flight deck (e.g. fuel master, load-planning agent, handling agent, etc.).
- (c) A delay of the aircraft might be justified for safety reasons, such as whenever non-compliances are detected and either need a corrective action before departure, or need proper identification/assessment by the operator, for example if:
 - (1) tyres appear to be worn beyond the limits (central groove no longer visible). However, reference is to be made to the applicable Aircraft Maintenance Manual (AMM) to determine the actual limit;
 - (2) oil leakage (e.g. 5 drops per minute) is to be checked against the applicable AMM to determine the actual limit;

- (3) a flight crew member cannot produce a valid licence. Clarification is to be sought from the operator to confirm that the flight crew member has a valid licence by requesting, for instance, a copy of the licence to be sent to the inspectors for verification.
- (4) missing relevant flight operational data (e.g. missing or incorrect performance calculation, incorrect operational flight plan, incorrect weight and balance calculation).

AMC1 ARO.RAMP.125(c) Conduct of ramp inspections

PROOF OF RAMP INSPECTION

- (a) On completion of the ramp inspection, information about its results should be provided to the pilot-in-command/commander or, in his/her absence, to another member of the flight crew or a representative of the operator, regardless of whether or not findings have been identified. When completing the Proof of Inspection (POI), the following should be taken into account:
 - (1) Only the remarks mentioned in the POI should be reported as findings in the final ramp inspection report. Any other relevant information which was not included in the POI should only be reported in the final report as a general remark under 'G' or in the additional information box.
 - (2) When handing over the POI to the pilot-in-command/commander or operator representative, the inspector should ask him/her to sign the POI whilst explaining that the signature does in no way imply acceptance of the listed findings. The signature only confirms that the POI has been received by the pilot-in-command/operator representative, and that the aircraft has been inspected on the date and at the place indicated.
- (b) POIs may be completed electronically, including the required signatures, and may be printed on site or delivered electronically (e.g. by e-mail). In either case, they should follow, to the greatest possible extent, the layout provided by EASA form 136, and should contain all the elements of such form.

ARO.RAMP.130 Categorisation of findings

For each inspection item, three categories of possible non-compliance with the applicable requirements are defined as findings. Such findings shall be categorised as follows:

- (1) a category 3 finding is any detected significant non-compliance with the applicable requirements or the terms of a certificate that has a major influence on safety;
- (2) a category 2 finding is any detected non-compliance with the applicable requirements or the terms of a certificate that has a significant influence on safety;
- (3) a category 1 finding is any detected non-compliance with the applicable requirements or the terms a certificate that has a minor influence on safety.

GM1 ARO.RAMP.130 Categorisation of findings

APPLICABLE REQUIREMENTS

- (a) For aircraft used by third country operators, applicable requirements are the ICAO international standards.
- (b) The relevant EU requirements apply to aircraft used by operators under the regulatory oversight of another Member State.
- (c) Manufacturers' standards should be used for checking the technical condition of the aircraft.
- (d) Published national standards (e.g. Aeronautical Information Publications (AIPs)) that are declared applicable to all operators flying to that State may also be checked. Deviations from national standards should be reported as findings only if they have an impact on safety. For such findings, the report should indicate 'N' in the column 'Std.' and the appropriate reference should be included in the column 'Ref.'. Any other deviation from national standards which does not have an impact on safety (e.g. insurance certificate in USD instead of SDR) should be recorded as category G (General Remark). Member States should develop guidance for the use of their inspectors on the enforcement of national standards.

GM2 ARO.RAMP.130 Categorisation of findings

ASSESSMENT OF NON-COMPLIANCES

- (a) When a non-compliance with the applicable requirements is identified, the inspector should be certain that the finding is applicable to the specific circumstances of the inbound and/or outbound flight. (e.g. for third country operators, no electric torch on board is, a finding, but only during night-flight operations; or insufficient number of life-vests, but only if the flight is overwater on a distance greater than 50 NM from the shore or when taking off or landing at an aerodrome where the take-off or approach path is so disposed over water that there would be a likelihood of a ditching). Nevertheless, such information should be reported as a general remark.
- (b) When a contracting state finds it impracticable to comply with an international standard, it is entitled to notify a difference to ICAO in accordance with Article 38 of the Chicago Convention. However, this right has its boundaries within the sovereign territory of other contracting States. It is not 'exportable' into other Contracting States. More precisely, there is no legal obligation for other Contracting States to accept within their territory an activity, organisation or object which has been certified or approved by a Contracting State according to such lower standards. So, for third country operators, a notification to ICAO of a difference in accordance with Article 38 of the Chicago Convention has no effect within the territory of another Contracting State. Therefore, in another State's territory the operator is obliged to:

- (1) either comply with the ICAO standard (Art. 37 in conjunction with Art. 33 of the Chicago Convention); or
- (2) comply with the mitigating measures accepted by the Agency in accordance with Regulation (EU) No 452/2014¹¹.

Notified differences may, however, be taken into account in the follow-up process of the ramp inspection report (as detailed in the follow-up procedures).

- (c) Compliance with the applicable requirements of aircraft and their crew is not only a responsibility of the operator. The State of operator, the State of licensing, and the State of registry are also responsible. The inspected operator might not be the responsible entity for certain non-compliances (e.g. related to the issuance of certificates of registration, of the AOC and/or personnel licences). Such non-compliances pertaining to the authority should be raised by the inspector as part of the ramp inspection process in accordance with ARO.RAMP and recorded as non-compliance in the ramp inspection report.
- (d) Non-compliances detected should, as much as possible, be documented and recorded as follows:
 - (1) pictures of the deficiency itself;
 - (2) pictures of the manufacturer references used to assess the technical defects;
 - (3) pictures or copy of the technical logbook entries performed.

Such documents or records could be very useful in the follow-up phases of the ramp inspection either to explain in detail and illustrate detected findings or to be able to exchange appropriate documented evidence when findings are challenged.

GM3 ARO.RAMP.130 Categorisation of findings

NON-COMPLIANCES WITH MANUFACTURER STANDARDS

- (a) A finding against manufacturer standards should always be demonstrated in relation to aircraft technical documentation such as: Aircraft Maintenance Manual (AMM), Structural Repair Manual (SRM), Configuration Deviation List (CDL), Wiring Diagram Manual (WDM), Standard Wiring Practices Manual (SWPM), etc., and MEL references. If significant defects are suspected, the operator should be asked to demonstrate compliance with the standards. Deviations from these standards can only be acceptable if the operator's competent authority has issued a formal waiver or concession detailing conditions and/or limitations to allow the aircraft to continue to operate for a specific period of time before final repair, or if the aircraft will perform a non-commercial flight (with less prescriptive standards and requirements), provided that the validity of the CofA is not affected.
- (b) With regard to non-compliances on missing fasteners, findings can only be raised if the maintenance documentation contains clear limits and/or dispatch conditions. In the absence of such clear manufacturer standards, inspectors should only raise findings if their expert judgement (possibly supported by licensed maintenance personnel) is such that similar circumstances on comparable aircraft would be considered to be out of limits.
- (c) In exceptional cases, a single fault may give rise to more than one finding under different inspection items, for example: a tyre worn beyond limits whilst the pilot-in-command refuses to

¹¹ Commission Regulation (EU) No 452/2014 of 29 April 2014 laying down technical requirements and administrative procedures related to air operations of third country operators pursuant to Regulation (EC) No 216/2008 of the European Parliament and of the Council.

enter the defect in the Technical Log (or equivalent) would trigger raising findings under both C04 and A23.

GM4 ARO.RAMP.130 Categorisation of findings

INSPECTION INSTRUCTIONS

- (a) The inspection instructions include the description, categorisation and reference to the applicable requirement.
- (b) Findings on arrival flights being identical to the findings raised for departure flights should lead to the same categorisation, although the corrective action might not be possible when the flight has been completed. For example, an incorrect mass and balance sheet (outside operational limits) found on arrival should be categorised as a category 3. Obviously, this cannot be corrected, however, the appropriate class 3 action could be to confirm that the mass and balance calculations are within operational limits for the outbound flight.
- (c) In exceptional cases, where multiple findings are inter-related and the impact on safety is higher, the category of such findings may be increased to reflect the impact on safety. The increase in category should be explained in the detailed description of the finding.

GM5 ARO.RAMP.130 Categorisation of findings

DETECTION, REPORTING AND ASSESSMENT OF SIGNIFICANT TECHNICAL DEFECTS

- (a) A technical defect is considered to be any material fault pertaining to the aircraft, its systems or components. Minor defects are typically without influence on safety and, therefore, the operator is deemed to be compliant. However, minor defects should be brought to the attention of the operator using general remarks as described in GM8 ARO.RAMP.130. Those defects which are potentially out of limits are considered to be significant defects. Further assessment is needed to determine if the significant defect is within or outside the applicable limits. Such defects should be known to the operator since they should have been detected during regular maintenance, aircraft acceptance procedure or pre-flight inspections.
- (b) Technical defects which were not detected by the operator, because the Approved Maintenance Programme (AMP) did not require the operator to detect such defects during turn-around inspections, do not necessarily qualify as a finding under A23/A24. Examples of such defects, which are not supposed to be part of the pre-flight inspection. are:
 - (1) missing fasteners,
 - (2) bonding wires,
 - (3) the cabin emergency lighting,

Manufacturer's data often contain limits on certain defects. Those data are normally to be used during scheduled maintenance. It is generally accepted that, in between scheduled maintenance, defects that are beyond those manufacturer's limit might appear. Inspectors should, therefore, be reluctant in using such limits during ramp inspections. However, where the manufacturer has specified dispatch limits, and the defect is beyond the dispatch limits, a category 3 finding should be raised.

- (c) Significant defects might have appeared during the inbound flight. If time allows the inspector should delay his/her own inspection of the aircraft condition until the operator has completed the pre-flight inspection, in order to give the operator the opportunity to identify and assess such a defect during the pre-flight inspection.

- (d) A 'defect within limits but not recorded' should not be considered as a technical non-compliance. Such discrepancies should be brought to the attention of the operator using general remarks as described in GM8 ARO.RAMP.130. If the significant defect appeared to be within limits, the safety focus changes from the defect itself to the non-compliance of the defect not being detected/assessed by the operator.

GM6 ARO.RAMP.130 Categorisation of findings

DETECTION, REPORTING AND ASSESSMENT OF SIGNIFICANT TECHNICAL DEFECTS

- (a) Before findings can be categorised, an assessment of the encountered situation should be made. The inspector can only allocate a proper category to the finding, if the extent of the non-compliance is clear. This implies that inspectors should not raise category 3 findings with the only intent to perform a further investigation/assessment. The Appendix to this GM provides a flowchart that can be used as guidance for the steps to be taken.
- (b) The following procedure should be used when inspecting Aircraft Condition (C-items) or, if appropriate, items A, B and D.
- (1) The inspector should delay the inspection of the aircraft until the operator has completed the pre-flight inspection, if time allows. However, he/she should always start with a quick check on the cargo compartment(s) after arrival of the aircraft.
 - (2) When the inspector performs the aircraft condition inspection in advance of the operator's pre-flight inspection, reporting defects identified should not be done before the operator has completed the pre-flight inspection.
 - (3) The inspector should subsequently check if the operator detected the significant defects found by the inspector, such as:
 - (i) leaks;
 - (ii) dents in pressurised areas of the fuselage; and
 - (iii) damages to emergency systems (e.g., escape hatches, escape slides, RAT, cargo compartment blow out panels).
 - (4) A single fastener missing in the middle of a fairing, traces of old leaks and non-structural damages to e.g. fairings can, in many cases, be considered as 'minor defects'. Such defects need to be pre-assessed by the inspector in accordance with the relevant manufacturer limitation instruction (e.g. AMM, SRM etc.)
 - (5) If the operator detected the significant defect, but did not report and/or assess it in accordance with the applicable procedures, the operator should assess the defect. If the defect appears to be within limits, a finding should be raised under A23 (Defect notification and rectification) mentioning 'Known defect not reported/assessed'. However, when collecting evidence for this finding, the inspector should take into account the reporting system used by the operator. For instance, if the operator uses a Technical Logbook and/or a damage chart, a finding could be raised if the defect was not entered. Additionally, a general remark should be created for such defect. If the defect is outside limits, a category 3 finding should be raised under the respective inspection item. In this case no supplementary finding related to this defect should be raised under A23.
 - (6) If the operator did not detect the significant defect, the inspector should inform the crew of the non-identified defects. Subsequently, the operator should assess the defect in order to determine if the defect is within or outside dispatch limits. If the defect is within limits, a category 2 finding mentioning 'Pre-flight inspection performed but without identifying

significant defects' should be raised under A24 (pre-flight inspection) addressing the deficiency that the defect was not detected. Additionally, a general remark should be made for the defect. If the defect is outside limits, a category 3 finding should be raised under the respective inspection item. In this case, no supplementary finding related to this defect should be raised under A24.

- (7) Multiple findings related to the same system or item should be grouped and reported as one finding. Examples of such findings are:
 - (i) Multiple category 2 findings raised under A23 or A24, if such findings concern the same system as per ATA system taxonomy (e.g. hydraulic leakage, fuel leakage,) and the non-compliance was not identified, reported or assessed); examples requiring regrouping hydraulic leakages which were identified but not assessed. Nonetheless, situations such as a fuel leakage on the left wing which was not identified and a fuel leakage on engine #2 which was reported but not assessed, should be noted as two separate findings.
 - (ii) Findings on missing fasteners.
- (8) If an operator performs the pre-flight inspection procedures (aircraft acceptance) only briefly before the departure of the aircraft, the inspector should wait until completion of the inspection before reporting identified defects to the operator. Although an assessment, which may cause a delay, might subsequently be needed once the inspector has informed the operator of those non-detected technical defects, the procedure established by the operator would have resulted in the same delays if the flight crew would have identified the defect requiring the associated assessment. Therefore, a pre-flight inspection performed by the operator close to departure entails risk of a delay.

Appendix to GM5 and GM6 ARO.RAMP.130

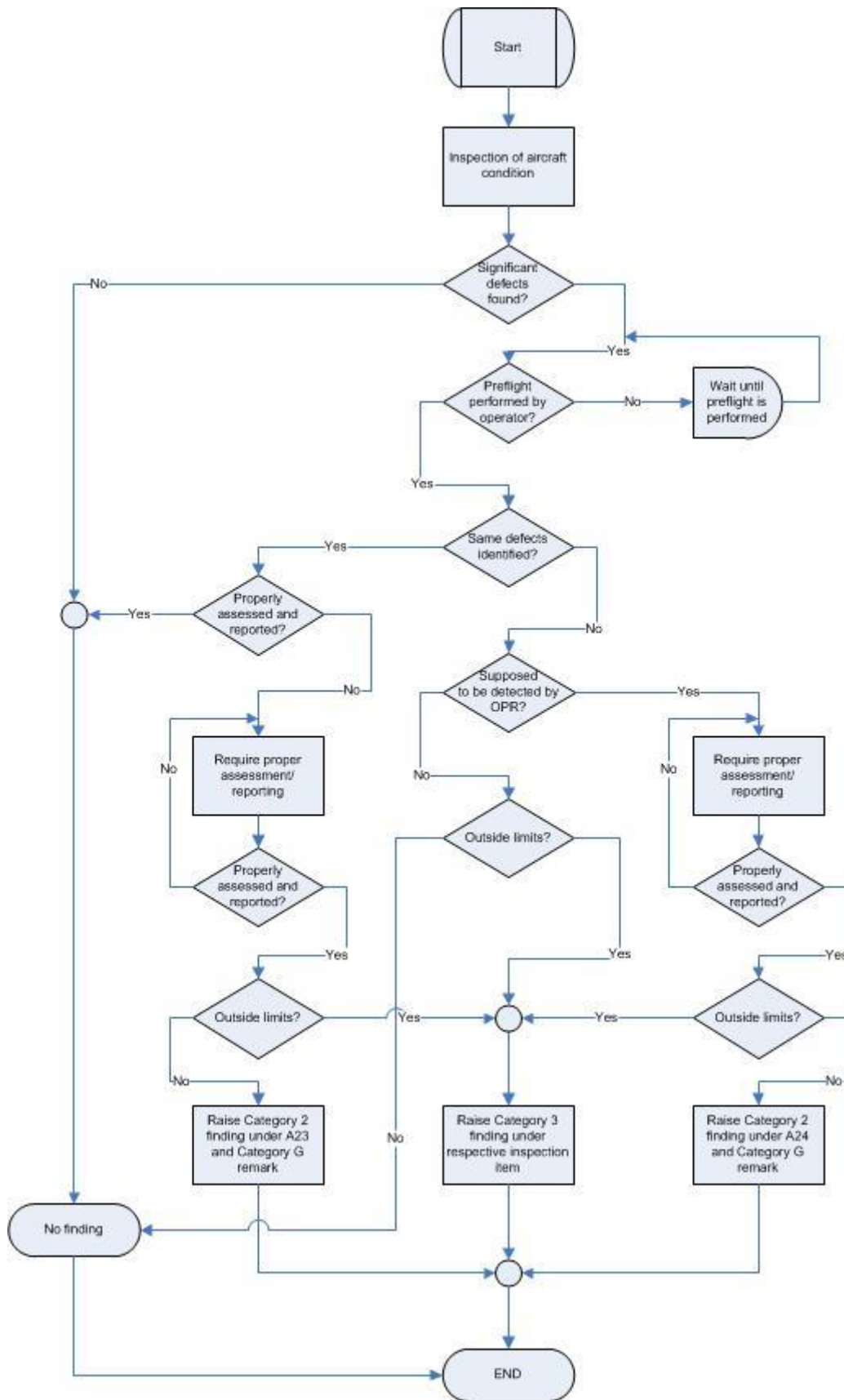

GM7 ARO.RAMP.130 Categorisation of findings

ASSESSMENT OF FINDINGS ON CERTIFICATES AND LICENSES PRIOR TO CATEGORISATION

- (a) The principle described in GM6 ARO.RAMP.130 should be applied for the assessment of findings on certificates and licenses prior to their categorisation.
- (b) Whenever a licence or a certificate is not carried on board (including AOC and OPS Specs), it may become clear that the impact on safety is less than initially foreseen after receiving a copy of a missing licence or certificate before departure. In this case, a category 1 finding should be raised and the relevant pre-described findings (PDFs) should be used regarding certificates and licenses not carried on board at the time of the inspection. If evidence is not provided before departure, a higher category of finding should be raised (for a missing certificate of registration or radio station license, the appropriate category 2 PDF should be used; for all other cases, the relevant category 3 PDF should be used. Under no circumstances should a flight crew member be permitted to perform flying duties without receiving confirmation that he/she has been issued an appropriate and valid licence.

GM8 ARO.RAMP.130 Categorisation of findings

USE OF GENERAL REMARKS

- (a) Although not classified as a non-compliance, any relevant safety issues identified during ramp inspections should be reported as a General Remark (category G) under each inspection item. For example:
 - (1) insufficient number of life jackets/flotation devices, however the flight was/will be over land;
 - (2) any non-compliance not recorded in the Proof of Inspection (POI), as well as any other relevant information;
 - (3) minor defects;
 - (4) non-compliances with operator/national standards whereas regulatory standards are met (e.g. smoke goggles at the work station in the cockpit unserviceable).
- (b) General remarks (as well as category 1 findings) do not require any follow-up action, either from the inspecting authority or for the operator/relevant oversight authority.

ARO.RAMP.135 Follow-up actions on findings

- (a) For a category 2 or 3 finding the competent authority, or where relevant the Agency, shall:
- (1) communicate the finding in writing to the operator, including a request for evidence of corrective actions taken; and
 - (2) inform the competent authority of the State of the operator and, where relevant, the State in which the aircraft is registered and where the licence of the flight crew was issued. Where appropriate, the competent authority or Agency shall request confirmation of their acceptance of the corrective actions taken by the operator in accordance with ARO.GEN.350 or ARO.GEN.355.
- (b) In addition to (a), in the case of a category 3 finding, the competent authority shall take immediate steps by:
- (1) imposing a restriction on the aircraft flight operation;
 - (2) requesting immediate corrective actions;
 - (3) grounding the aircraft in accordance with ARO.RAMP.140; or
 - (4) imposing an immediate operating ban in accordance with Article 6 of Regulation (EC) No 2111/2005.
- (c) When the Agency has raised a category 3 finding, it shall request the competent authority where the aircraft is landed to take the appropriate measures in accordance with (b).

AMC1 ARO.RAMP.135(a) Follow-up actions on findings

FOLLOW-UP ACTIONS FOR CATEGORY 2 OR 3 FINDINGS

- (a) Exceptionally, where multiple category 2 findings have been raised and the accumulation of these findings or their interaction justifies corrective action before the flight takes place, the class of action may be increased to the actions foreseen by ARO.RAMP.135(b).
- (b) When communicating findings to the operator, the inspecting authority should:
- (1) use the database as the primary communication channel with the operator and limit communication via other channels.
 - (2) request evidence of corrective/preventive actions taken, or alternatively the submission of a corrective action plan followed by evidence that planned corrective actions have been taken.
 - (3) communicate findings to the operator's focal points, the operational department or the management or, failing this, the quality department.
 - (4) monitor if the operator has provided a response to the findings, as required, and if such response gives sufficient reason, or if further information is needed to close findings, evidence of corrective actions taken might be the actual implementation of a corrective action plan. It is then for the inspecting authority to decide, based on the related risk and impact, whether or not a finding may be closed based on proposed corrective actions and taking into account the severity and previous recurrence of detected findings. Depending on the severity and recurrence of the findings raised, the inspecting authority may consider the actual closure of the findings in other report(s) containing the same findings only after having received satisfactory documented evidence of appropriate implementation of actions meant to prevent the reoccurrence of the non-compliance.

- (5) inform the operator's competent authority and the operator no later than 10 working days after the inclusion of the report in the database in order to permit appropriate action to be taken, as well as to confirm to the operator the findings raised. The primary source of information to enable operators to take swift action to address safety deficiencies is the database
 - (6) upload in the database information on possible actions taken and responses provided by the operator following the RAMP inspection and send a communication to the operator only if the operator's actions have not been satisfactory.
 - (7) give the operator a period of 30 days to reply. If the operator does not react to the initial communication within this period, a second request should be sent, including a specific period of days to reply (e.g. 15 working days) whilst copying the operator's competent authority. If the second attempt is also unsuccessful, the operator's competent authority should be requested to encourage the operator to reply. The inspecting authority should indicate in such request that no reaction from the operator could be interpreted as a 'lack of ability and/or willingness of an operator to address safety deficiencies' under Regulation (EC) No 2111/2005.
- (c) In general, no reply is expected when informing the State(s) of oversight. However, findings which indicate possible shortcomings at State level should be emphasised, e.g. when the medical certificate does not indicate the medical class or type/instrument rating validation/expiration date is not mentioned. For such findings, which are out of the control of the operator, the State of oversight should be asked for corrective actions. When assessing the operator's corrective action (plan), it should be accepted that, for such non-compliances, the issue should be escalated to the oversight authority.
- (d) The following are examples requiring a confirmation of the inspecting authority regarding its acceptance of the corrective actions taken by the operator:
- (1) identification of a high number of non-compliances;
 - (2) repetition of same findings;
 - (3) lack of an adequate response from the operator;
 - (4) evidence of consistent non-compliance with a particular standard also detected during ramp inspections of other operators from that State;
 - (5) action by the competent authority may be required given the severity of the findings.
- The inspecting authority should monitor if the State(s) of oversight has replied to any requests for confirmation made and if the response is satisfactory. Should the response be unsatisfactory, the communication should be re-launched following the procedure described in (b)(6) above.
- (e) Any follow-up communication from operators and States of oversight should be acknowledged, and they should be informed about the closure of findings. Requests for clarification should be responded by the inspecting authority. Acknowledgement or clarifications from the inspecting authority should be given within 30 working days after receipt of communications or requests.
- (f) When communicating a finding to the operator, and in any further correspondence from the inspecting authority, the operator's competent authority should, as much as possible, be copied in the communication, as it might contain relevant information for its oversight activities. This is particularly the case for information on the closure of ramp inspections findings sent by the inspecting authority (sent either by e-mail or by official letter).
- (g) Findings should remain 'open' as long as no satisfactory response of the operator and/or the State(s) of oversight was received. However, findings could be closed if it could be confirmed, as

an example by means of additional inspection(s), that appropriate corrective action was taken. Whenever there is further communication to the operator, evidence of such could be uploaded as report attachments.

- (h) If the inspecting authority received evidence from a relevant oversight authority showing that the operator does not exist anymore, all related findings should be closed and the reason for closure explained in the justification.
- (i) A finding raised during a ramp inspection to which the inspecting authority has not received detailed corrective and/or preventive actions from the operator concerned or from its State(s) of oversight, should be considered as closed in the follow-up part of the ramp inspection process, if the acceptance of mitigating measures in accordance with Regulation (EU) No 452/2014 ensures an equivalent level of safety to that achieved by the standards to which differences have been notified to ICAO by non-EU Member States.

AMC1 ARO.RAMP.135(b) Follow-up actions on findings

CLASSES OF CATEGORY 3 FINDINGS

- (a) In the case of a category 3 finding, the action(s) taken before departure of the aircraft should be verified.
- (b) Whenever restrictions on the aircraft flight operation (Class 3a action) have been imposed, it is appropriate to conduct appropriate verification of adherence to such restrictions. Examples of Class 3a actions, and related verification, are, but not limited to:
 - (1) restrictions on flight altitudes if oxygen system deficiencies have been found. This might be verified by checking the ATC flight plans and/or the actual altitude flown as reported by the EUROCONTROL CFMU system;
 - (2) a non-commercial flight to the home base, if allowed by applicable requirements and the MEL (provided that the validity of the CofA is not affected);
 - (3) seats that may not be used by passengers might be verified just before departure to confirm that seats are not occupied;
 - (4) a cargo area that may not be used;
 - (5) operational restrictions mandating the use of specific runways;
 - (6) restrictions to specific environmental conditions (such as departure under visual meteorological conditions (VMC) only).
- (c) Whenever the operator is required to take corrective actions before departure (Class 3b), inspectors should verify that the operator has taken such actions. Examples of immediate corrective actions to be taken before departure are:
 - (1) (temporary) repairs to defects according to the manufactures definitions (e.g. AMM and/or SRM);
 - (2) recalculation of mass and balance, performance calculations and/or fuel figures;
 - (3) a copy of a missing licence/document to be sent by fax or other electronic means;
 - (4) proper restraining of cargo.

If inspectors have imposed corrective actions, they should be mentioned in the 'Class of actions' field on the ramp inspection report. If the operator took voluntarily corrective actions to address a category 1 or a category 2 finding before the flight, it should be reported in the 'Additional information' field only.

- (d) An aircraft following a Class 3c finding should be grounded only if the crew refuses to take the necessary corrective actions or to respect imposed restrictions on the aircraft flight operation. However, grounding might be appropriate if an operator refuses to grant access in accordance with ORO.GEN.140 (in case of an EU operator) or contrary to Regulation (EU) 452/2014 (in case of a third country operator). The inspecting authority should then ensure that the aircraft will not depart as long as the reasons for the grounding remain. Any records of communication undertaken pursuant to ARO.RAMP.140(b), as well as other evidences, should be collected and kept as evidential material.
- (e) Evidence related to findings on licences and certificates should be provided by the authority that issued the licence or certificate. However, if that authority is not able to provide such evidence in time, the inspecting authority may accept evidence from other sources, provided that it seeks confirmation of the validity of such evidence at the earliest opportunity with the authority that issued the licence or certificate. The ramp inspection report should mention which evidence was provided and by whom, including when necessary subsequent confirmation from the authority that issued the licence or certificate.
- (f) In exceptional cases it might not be necessary to verify if the restrictions resulting from a category 3 finding are followed or if corrective actions have been taken (e.g. if the inspector has indications that appropriate actions will be taken), or if they are possible (e.g. for flight segments outside the EUROCONTROL area). The inspecting authority should determine on a case by case basis if it is necessary or feasible to verify that restrictions are respected or if corrective actions have been taken.

GM1 ARO.RAMP.135(b) Follow-up actions on findings

CLASSES OF CATEGORY 3 FINDINGS

- (a) The inspecting authority could impose an immediate operating ban (Class 3d) on an operator under Article 6 of Regulation (EC) No 2111/2005. A Class 3d action is usually imposed in addition to a Class 3a, 3b or 3c action. Therefore, its further follow-up as regards the EU Ramp Inspection Programme, is considered to be covered by the follow-up of those actions.
- (b) If category 3 findings that have been raised concern non-compliances that affect the validity of the certificate of airworthiness of the aircraft, this should be communicated immediately to the State responsible for overseeing the airworthiness of the aircraft. Although the first contact may be, as a matter of urgency, accomplished by telephone, it is advisable to inform the state concerned in writing. For ICAO guidance on this matter, refer to ICAO Annex 8, Part II, Chapter 3.5 — Temporary Loss of Airworthiness.
- (c) If the a posteriori verification shows that the operator did not respect the restrictions imposed, this information should be mentioned in the final ramp inspection report or should be reported in accordance with ARO.RAMP.145(b) and (c).

ARO.RAMP.140 Grounding of aircraft

- (a) In the case of a category 3 finding where it appears that the aircraft is intended or is likely to be flown without completion by the operator or owner of the appropriate corrective action, the competent authority shall:
- (1) notify the pilot-in-command/commander or the operator that the aircraft is not permitted to commence the flight until further notice; and
 - (2) ground that aircraft.
- (b) The competent authority of the State where the aircraft is grounded shall immediately inform the competent authority of the State of the operator and of the State in which the aircraft is registered, if relevant, and the Agency in the case of a grounded aircraft used by a third-country operator.
- (c) The competent authority shall, in coordination with the State of the operator or the State of Registry, prescribe the necessary conditions under which the aircraft can be allowed to take-off.
- (d) If the non-compliance affects the validity of the certificate of airworthiness of the aircraft, the grounding shall only be lifted by the competent authority when the operator shows evidence that:
- (1) compliance with the applicable requirements has been re-established;
 - (2) it has obtained a permit-to-fly in accordance with Commission Regulation (EC) No 1702/2003¹², for aircraft registered in a Member State;
 - (3) a permit-to-fly or equivalent document of the State of Registry or the State of the operator for aircraft registered in a third country and operated by an EU or a third country operator; and
 - (4) permission from third countries which will be overflown, if applicable.

GM1 ARO.RAMP.140(a) Grounding of aircraft**AIRCRAFT LIKELY TO BE FLOWN WITHOUT COMPLETION OF APPROPRIATE CORRECTIVE ACTION**

Should an operator refuse to permit the performance of a ramp inspection without valid reasons, the inspecting authority should consider grounding of the aircraft. In such a case, the inspecting authority must immediately undertake the relevant communication in accordance with ARO.RAMP.140(b).

GM1 ARO.RAMP.140(d)(4) Grounding of aircraft**LIFTING OF A GROUNDING**

Aircraft with a permit to fly issued by a competent authority of an EASA State of registry do not need permission from other EASA Member States to be overflown.

¹² OJ L 243, 27.9.2003, p. 6.

ARO.RAMP.145 Reporting

- (a) Information collected in accordance with ARO.RAMP.125(a) shall be entered into the centralised database referred to in ARO.RAMP.150(b)(2), within 21 calendar days after the inspection.
- (b) The competent authority or the Agency shall enter into the centralised database any information useful for the application of Regulation (EC) No 216/2008 and its Implementing Rules and for the accomplishment by the Agency of the tasks assigned to it by this Annex, including the relevant information referred to in ARO.RAMP.110.
- (c) Whenever the information as referred to in ARO.RAMP.110 shows the existence of a potential safety threat, such information shall also be communicated to each competent authority and the Agency without delay.
- (d) Whenever information concerning aircraft deficiencies is given by a person to the competent authority, the information referred to in ARO.RAMP.110 and ARO.RAMP.125(a) shall be de-identified regarding the source of such information.

GM1 ARO.RAMP.145(b) Reporting

IMPORTANT SAFETY INFORMATION

- (a) Safety-related information should be verified by the reporting authority, as far as possible, before insertion in the centralised database pursuant to ARO.RAMP.110. However, credible safety information received voluntarily (e.g. whistleblower reports) which can be verified by means of ramp inspections should also be reported.
- (b) If available, any relevant information contained in documents and pictures should be attached to the 'Standard report' available in the centralised database.
- (c) Significant safety-related occurrences where, in addition to the follow-up required by occurrence reporting requirements, ramp checks of an aircraft or operator are desirable include (among others):
 - (1) ATC reports on level-busts;
 - (2) communication failure or difficulties;
 - (3) non-standard take-off lengths;
 - (4) information received from maintenance organisations with regard to lack of AD compliance or maintenance work performed incorrectly;
 - (5) reports from the general public/whistleblower concerning perceived unsafe situations;
 - (6) reports from airport personnel on observed unsafe practices; or
 - (7) factual information concerning accidents and serious incidents which occurred in Member States' airspace.

ARO.RAMP.150 Agency coordination tasks

- (a) The Agency shall manage and operate the tools and procedures necessary for the storage and exchange of:
- (1) the information referred to in ARO.RAMP.145, using the forms as established in Appendices III and IV;
 - (2) the information provided by third countries or international organisations with whom appropriate agreements have been concluded with the EU, or organisations with whom the Agency has concluded appropriate arrangements in accordance with Article 27(2) of Regulation (EC) No 216/2008.
- (b) This management shall include the following tasks:
- (1) store data from the Member States relevant to the safety information on aircraft landing at aerodromes located in the territory subject to the provisions of the Treaty;
 - (2) develop, maintain and continuously update a centralised database containing all the information referred to in (a)(1) and (2);
 - (3) provide necessary changes and enhancements to the database application;
 - (4) analyse the centralised database and other relevant information concerning the safety of aircraft and of air operators and, on that basis:
 - (i) advise the Commission and the competent authorities on immediate actions or follow-up policy;
 - (ii) report potential safety problems to the Commission and to the competent authorities;
 - (iii) propose coordinated actions to the Commission and to the competent authorities, when necessary on safety grounds, and ensure coordination at the technical level of such actions;
 - (5) liaise with other European institutions and bodies, international organisations and third country competent authorities on information exchange.

ARO.RAMP.155 Annual report

The Agency shall prepare and submit to the Commission an annual report on the ramp inspection system containing at least the following information:

- (a) status of the progress of the system;
- (b) status of the inspections performed in the year;
- (c) analysis of the inspection results with indication of the categories of findings;
- (d) actions taken during the year;
- (e) proposals for further improving the ramp inspection system; and
- (f) annexes containing lists of inspections sorted out by State of operation, aircraft type, operator and ratios per item.

ARO.RAMP.160 Information to the public and protection of information

- (a) Member States shall use the information received by them pursuant to ARO.RAMP.105 and ARO.RAMP.145 solely for the purpose of Regulation (EC) No 216/2008 and its implementing rules and shall protect it accordingly.
- (b) The Agency shall publish an aggregated information report annually that shall be available to the public containing the analysis of the information received in accordance with ARO.RAMP.145. The report shall be simple and easy to understand, and the source of the information shall be de-identified.

GM1 ARO.RAMP.160(a) Information to the public and protection of information

PROTECTION OF INFORMATION FROM RAMP INSPECTIONS

In accordance with their national legislation on freedom of information, Member States can disclose information from ramp inspections that they have conducted. When a request for access to information regarding a ramp inspection conducted by another State is made, the Member State receiving the request should forward it to the inspecting State and inform the requester accordingly.

APPENDIX I

<p>AIR OPERATOR CERTIFICATE (Approval schedule for air transport operators)</p>											
<p>Types of operation: Commercial air transport (CAT) <input type="checkbox"/> Passengers; <input type="checkbox"/> Cargo; <input type="checkbox"/> Other¹:.....</p>											
5	<table border="1" style="width: 100%; border-collapse: collapse;"> <tr> <td style="padding: 5px;">State of the Operator³</td> <td rowspan="2" style="width: 20%; padding: 5px; vertical-align: top;">5</td> </tr> <tr> <td style="padding: 5px;">Issuing Authority⁴</td> </tr> </table>	State of the Operator ³	5	Issuing Authority ⁴							
State of the Operator ³	5										
Issuing Authority ⁴											
AOC # ⁶ :	<table border="1" style="width: 100%; border-collapse: collapse;"> <tr> <td style="padding: 5px;">Operator Name⁷</td> <td rowspan="4" style="width: 20%; padding: 5px; vertical-align: top;">Operational Points of Contact:⁹ Contact details, at which operational management can be contacted without undue delay, are listed in¹².</td> </tr> <tr> <td style="padding: 5px;">Dba Trading Name⁸</td> </tr> <tr> <td style="padding: 5px;">Operator address¹⁰:</td> </tr> <tr> <td style="padding: 5px;">Telephone¹¹:</td> </tr> <tr> <td style="padding: 5px;">Fax:</td> <td></td> </tr> <tr> <td style="padding: 5px;">E-mail:</td> <td></td> </tr> </table>	Operator Name ⁷	Operational Points of Contact: ⁹ Contact details, at which operational management can be contacted without undue delay, are listed in ¹² .	Dba Trading Name ⁸	Operator address ¹⁰ :	Telephone ¹¹ :	Fax:		E-mail:		
Operator Name ⁷	Operational Points of Contact: ⁹ Contact details, at which operational management can be contacted without undue delay, are listed in ¹² .										
Dba Trading Name ⁸											
Operator address ¹⁰ :											
Telephone ¹¹ :											
Fax:											
E-mail:											
<p>This certificate certifies that¹³ is authorised to perform commercial air operations, as defined in the attached operations specifications, in accordance with the operations manual, Annex IV to Regulation (EC) No 216/2008 and its Implementing Rules.</p>											
Date of issue ¹⁴ :	<table border="1" style="width: 100%; border-collapse: collapse;"> <tr> <td style="padding: 5px;">Name and Signature¹⁵:</td> </tr> <tr> <td style="padding: 5px;">Title:</td> </tr> </table>		Name and Signature ¹⁵ :	Title:							
Name and Signature ¹⁵ :											
Title:											

1. Other type of transportation to be specified.

3. Replaced by the name of the State of the Operator.
4. Replaced by the identification of the issuing competent authority.
5. For use of the competent authority.
6. Approval reference, as issued by the competent authority.
7. Replaced by the operator’s registered name.
8. Operator’s trading name, if different. Insert “Dba” (for “Doing business as”) before the trading name.
9. The contact details include the telephone and fax numbers, including the country code, and the e-mail address (if available) at which operational management can be contacted without undue delay for issues related to flight operations, airworthiness, flight and cabin crew competency, dangerous goods and other matters as appropriate.

-
10. Operator's principal place of business address.
 11. Operator's principal place of business telephone and fax details, including the country code. E-mail to be provided if available.
 12. Insertion of the controlled document, carried on board, in which the contact details are listed, with the appropriate paragraph or page reference. E.g.: "Contact details ... are listed in the operations manual, gen/basic, chapter 1, 1.1"; or "... are listed in the operations specifications, page 1"; or "... are listed in an attachment to this document".
 13. Operator's registered name.
 14. Issue date of the AOC (dd-mm-yyyy).
 15. Title, name and signature of the competent authority representative. In addition, an official stamp may be applied on the AOC.

EASA FORM 138 Issue 1

APPENDIX II

OPERATIONS SPECIFICATIONS (subject to the approved conditions in the operations manual)				
Issuing Authority Contact Details Telephone ⁽¹⁾ : _____; Fax: _____; E-mail: _____				
AOC ⁽²⁾ :	Operator Name ⁽³⁾ : Db a Trading Name	Date ⁽⁴⁾ :	Signature:	
Operations Specifications:				
Aircraft Model ⁽⁵⁾ : Registration Marks ⁽⁶⁾ :				
Commercial operations <input type="checkbox"/>				
Area of operation ⁽⁷⁾ :				
Special Limitations ⁽⁸⁾ :				
Specific Approvals:	Yes	No	Specification ⁽⁹⁾	Remarks
Dangerous Goods	<input type="checkbox"/>	<input type="checkbox"/>		
Low Visibility Operations Take-off Approach and Landing	<input type="checkbox"/>	<input type="checkbox"/>	CAT ⁽¹⁰⁾ RVR ⁽¹¹⁾ : m DA/H: ft RVR: m	
RVSM ⁽¹²⁾ <input type="checkbox"/> N/A	<input type="checkbox"/>	<input type="checkbox"/>		
ETOPS ⁽¹³⁾ <input type="checkbox"/> N/A	<input type="checkbox"/>	<input type="checkbox"/>	Maximum diversion time ⁽¹⁴⁾ : min.	
Complex navigation specifications for PBN operations ⁽¹⁵⁾	<input type="checkbox"/>	<input type="checkbox"/>		(16)
Minimum navigation performance specification	<input type="checkbox"/>	<input type="checkbox"/>		
Helicopter operations with the aid of night vision imaging systems	<input type="checkbox"/>	<input type="checkbox"/>		
Helicopter hoist operations	<input type="checkbox"/>	<input type="checkbox"/>		

Helicopter emergency medical service operations	<input type="checkbox"/>	<input type="checkbox"/>		
Helicopter offshore operations	<input type="checkbox"/>	<input type="checkbox"/>		
Cabin crew training ⁽¹⁷⁾	<input type="checkbox"/>	<input type="checkbox"/>		
Issue of CC attestation ⁽¹⁸⁾	<input type="checkbox"/>	<input type="checkbox"/>		
Continuing airworthiness	<input type="checkbox"/>	<input type="checkbox"/>	⁽¹⁹⁾	
Others ⁽²⁰⁾				

- (1) Telephone and fax contact details of the competent authority, including the country code. E-mail to be provided if available.
- (2) Insertion of associated air operator certificate (AOC) number.
- (3) Insertion of the operator's registered name and the operator's trading name, if different. Insert 'DbA' before the trading name (for 'Doing business as').
- (4) Issue date of the operations specifications (dd-mm-yyyy) and signature of the competent authority representative.
- (5) Insertion of ICAO designation of the aircraft make, model and series, or master series, if a series has been designated (e.g. Boeing-737-3K2 or Boeing-777-232).
- (6) Either the registration marks are listed in the operations specifications or in the operations manual. In the latter case, the related operations specifications must make a reference to the related page in the operation manual. In case not all specific approvals apply to the aircraft model, the registration marks of the aircraft could be entered in the remark column to the related specific approval.
- (7) Listing of geographical area(s) of authorised operation (by geographical coordinates or specific routes, flight information region or national or regional boundaries).
- (8) Listing of applicable special limitations (e.g. VFR only, Day only, etc.).
- (9) List in this column the most permissive criteria for each approval or the approval type (with appropriate criteria).
- (10) Insertion of applicable precision approach category: LTS CAT I, CAT II, OTS CAT II, CAT IIIA, CAT IIIB or CAT IIIC. Insertion of minimum runway visual range (RVR) in meters and decision height (DH) in feet. One line is used per listed approach category.
- (11) Insertion of approved minimum take-off RVR in metres. One line per approval may be used if different approvals are granted.
- (12) Not Applicable (N/A) box may be checked only if the aircraft maximum ceiling is below FL290.
- (13) Extended range operations (ETOPS) currently applies only to two-engined aircraft. Therefore, the Not Applicable (N/A) box may be checked if the aircraft model has more or less than two engines.
- (14) The threshold distance may also be listed (in NM), as well as the engine type.
- (15) Performance-Based Navigation (PBN): one line is used for each complex PBN specific approval (e.g. RNP AR APCH), with appropriate limitations listed in the 'Specifications' and/or 'Remarks' columns. Individual approvals of specific RNP AR APCH procedures may be listed in the operations

specifications or in the operations manual. In the latter case, the related operations specifications should have a reference to the related page in the operations manual.

- (16) Specify if the specific approval is limited to certain runway ends and/or aerodromes.
- (17) Approval to conduct the training course and examination to be completed by applicants for a cabin crew attestation as specified in Annex V (Part-CC) to Commission Regulation (EU) No 1178/2011.
- (18) Approval to issue cabin crew attestations as specified in Annex V (Part-CC) to Commission Regulation (EU) No 1178/2011.
- (19) The name of the person/organisation responsible for ensuring that the continuing airworthiness of the aircraft is maintained and a reference to the regulation that requires the work, i.e. Annex I (Part-M), Subpart G to Commission Regulation (EU) [1321/2014](#).
- (20) Other approvals or data can be entered here, using one line (or one multi-line block) per authorisation (e.g. short landing operations, steep approach operations, helicopter operations to/from a public interest site, helicopter operations over a hostile environment located outside a congested area, helicopter operations without a safe forced landing capability, operations with increased bank angles, maximum distance from an adequate aerodrome for two-engined aeroplanes without an ETOPS approval, aircraft used for non-commercial operations).

EASA Form 139 Issue 2

APPENDIX III

Proof of Ramp Inspection					
Date:		Time:		Place:	
Operator:			State:	AOC no.:	
Route from:		Flight no:		Route to:	Flight no:
Flight type:	Chartered by Operator:			Aircraft type:	Aircraft configuration:
Charterer's State:			Registration mark:	Construction no:	
Flight crew State(s) of licensing:		Acknowledgement of Receipt ^(*)			
		Name:		Signature:	
Function:					

Free format information of competent authority (Logo, contact details tel/fax/email)

		Check	Remark			Check	Remark			Check	Remark	
A	Flight deck											
	1	General condition										
	2	Emergency exit										
	3	Equipment										
		Documentation										
	4	Manuals										
	5	Checklists										
	6	Navigation/instrument charts										
	7	Minimum equipment list										
	8	Certificate of registration										
	9	Noise certificate (where applicable)										
	10	AOC or equivalent										
	11	Radio licence										
	12	Certificate of Airworthiness										
	Flight data											
13	Flight preparation											
14	Mass and balance calculation											
	Safety equipment											
15	Hand fire extinguishers											
16	Life-jackets / flotation devices											
17	Harness											
18	Oxygen equipment											
19	Independent Portable light											
B	Cabin Safety											
	1	General internal condition										
	2	Cabin crew station and crew rest area										
	3	First-aid kit / Emergency medical kit										
	4	Hand fire extinguishers										
	5	Life-jackets / flotation devices										
	6	Seat belt and seat condition										
	7	Emergency exit, lighting and Independent Portable light										
	8	Slides /Life-rafts (as required), ELT										
	9	Oxygen Supply (Cabin Crew and Passengers)										
	10	Safety Instructions										
	11	Cabin crew members										
	12	Access to emergency exits										
	13	Stowage of passenger baggage										
14	Seat capacity											
C	Aircraft condition											
	1	General external condition										
	2	Doors and hatches										
	3	Flight controls										
	4	Wheels, tyres and brakes										
	5	Undercarriage, skids/floats										
	6	Wheel well										
	7	Powerplant and pylon										
	8	Fan blades, Propellers, Rotors (main/tail)										
	9	Obvious repairs										
	10	Obvious unrepaired damage										
11	Leakage											
D	Cargo											
	1	General condition of cargo compartment										
	2	Dangerous goods										
	3	Cargo stowage										
E	General											
	1	General										

Action Taken	Inspection Item	Category	Remarks
(3d) Immediate operating ban			
(3c) Aircraft grounded by inspecting NAA			
(3b) Corrective actions before flight			
(3a) Restrictions on the aircraft operation			
(2) Information to the authority and operator			
(1) Information to the pilot-in-command/			
(0) No remarks			
Inspector(s) sign or code			
Crew comments (if any):			
<p>(*) Signature by any member of the crew or other representative of the inspected operator does in no way imply acceptance of the listed findings but simply a confirmation that the aircraft has been inspected on the date and at the place indicated on this document.</p> <p>This report represents an indication of what was found on this occasion and must not be construed as a determination that the aircraft is fit for the intended flight. Data submitted in this report can be subject to changes upon entering into the centralised database.</p>			

APPENDIX IV

Ramp inspection report



Competent Authority (*name*)

(*State*)

Ramp Inspection Report

NR:-.....-.....

Source: RI

Date:-.....-.....

Place:

Local time::.....

Operator:

AOC Number:

State:

Type of Operation:

Route from:-.....-.....

Flight Number:

Route to:-.....-.....

Flight Number:

Chartered by Operator*:

Charterer's State*:

** (where applicable)*

Aircraft Type:.....-.....

Registration Marks:

Aircraft Configuration:

Construction Number:-.....

Flight crew: State of Licensing:

2nd State of Licensing*:

** (where applicable)*

Findings:

Code / Std / Ref / Cat / Finding	Detailed Description
.....-.....-.....-.....
.....-.....-.....-.....
.....-.....-.....-.....
.....-.....-.....-.....
.....-.....-.....-.....

Class of actions taken: Detailed Description

- 3d) Immediate operating ban
- 3c) Aircraft grounded by inspecting competent authority.....
- 3b) Corrective actions before flight.....

3a) Restriction on aircraft flight operation.....

2) Information to the competent authority and Operator

1) Information to pilot-in-command

Additional information (if any)

Inspector's names or no:

- This report represents an indication of what was found on this occasion and must not be construed as a determination that the aircraft is fit for the intended flight.

- Data submitted in this report can be subject to changes for correct wording upon entering into the centralised database.

Item Code	Checked	Remark
A. Flight Deck		
General		
1. General Condition	1. <input type="checkbox"/>	1. <input type="checkbox"/>
2. Emergency Exit.....	2. <input type="checkbox"/>	2. <input type="checkbox"/>
3. Equipment.....	3. <input type="checkbox"/>	3. <input type="checkbox"/>
Documentation		
4. Manuals	4. <input type="checkbox"/>	4. <input type="checkbox"/>
5. Checklists.....	5. <input type="checkbox"/>	5. <input type="checkbox"/>
6. Radio Navigation Charts	6. <input type="checkbox"/>	6. <input type="checkbox"/>
7. Minimum Equipment List	7. <input type="checkbox"/>	7. <input type="checkbox"/>
8. Certificate of registration.....	8. <input type="checkbox"/>	8. <input type="checkbox"/>
9. Noise certificate (where applicable)	9. <input type="checkbox"/>	9. <input type="checkbox"/>
10. AOC or equivalent	10. <input type="checkbox"/>	10. <input type="checkbox"/>
11. Radio licence	11. <input type="checkbox"/>	11. <input type="checkbox"/>
12. Certificate of Airworthiness (C of A).....	12. <input type="checkbox"/>	12. <input type="checkbox"/>
Flight data		
13. Flight preparation	13. <input type="checkbox"/>	13. <input type="checkbox"/>
14. Mass and balance calculation.....	14. <input type="checkbox"/>	14. <input type="checkbox"/>
Safety Equipment		
15. Hand fire extinguishers	15. <input type="checkbox"/>	15. <input type="checkbox"/>
16. Life-jackets / flotation device.....	16. <input type="checkbox"/>	16. <input type="checkbox"/>
17. Harness	17. <input type="checkbox"/>	17. <input type="checkbox"/>
18. Oxygen equipment	18. <input type="checkbox"/>	18. <input type="checkbox"/>

19. <i>Independent Portable light</i>	19.	<input type="checkbox"/>	19.	<input type="checkbox"/>
Flight Crew				
20. <i>Flight crew licence/composition</i>	20.	<input type="checkbox"/>	20.	<input type="checkbox"/>
Journey logbook / Technical log or equivalent				
21. <i>Journey log book, or equivalent</i>	21.	<input type="checkbox"/>	21.	<input type="checkbox"/>
22. <i>Maintenance release</i>	22.	<input type="checkbox"/>	22.	<input type="checkbox"/>
23. <i>Defect notification and rectification (incl. Tech log)</i>	23.	<input type="checkbox"/>	23.	<input type="checkbox"/>
24. <i>Pre-flight inspection</i>	24.	<input type="checkbox"/>	24.	<input type="checkbox"/>
B. Cabin Safety				
1. <i>General Internal Condition</i>	1.	<input type="checkbox"/>	1.	<input type="checkbox"/>
2. <i>Cabin crew stations and crew rest area</i>	2.	<input type="checkbox"/>	2.	<input type="checkbox"/>
3. <i>First-aid kit/ Emergency medical kit</i>	3.	<input type="checkbox"/>	3.	<input type="checkbox"/>
4. <i>Hand fire extinguishers</i>	4.	<input type="checkbox"/>	4.	<input type="checkbox"/>
5. <i>Life-jackets / Flotation devices</i>	5.	<input type="checkbox"/>	5.	<input type="checkbox"/>
6. <i>Seat belt and seat condition</i>	6.	<input type="checkbox"/>	6.	<input type="checkbox"/>
7. <i>Emergency exit, lighting and Independent Portable light</i>	7.	<input type="checkbox"/>	7.	<input type="checkbox"/>
8. <i>Slides /Life-rafts (as required), ELT</i>	8.	<input type="checkbox"/>	8.	<input type="checkbox"/>
9. <i>Oxygen Supply (Cabin Crew and Passengers)</i>	9.	<input type="checkbox"/>	9.	<input type="checkbox"/>
10. <i>Safety Instructions</i>	10.	<input type="checkbox"/>	10.	<input type="checkbox"/>
11. <i>Cabin crew members</i>	11.	<input type="checkbox"/>	11.	<input type="checkbox"/>
12. <i>Access to emergency exits</i>	12.	<input type="checkbox"/>	12.	<input type="checkbox"/>
13. <i>Stowage of passenger baggage's</i>	13.	<input type="checkbox"/>	13.	<input type="checkbox"/>
14. <i>Seat capacity</i>	14.	<input type="checkbox"/>	14.	<input type="checkbox"/>
Item Code		Checked		Remark
C. Aircraft Condition				
1. <i>General external condition</i>	1.	<input type="checkbox"/>	1.	<input type="checkbox"/>
2. <i>Doors and hatches</i>	2.	<input type="checkbox"/>	2.	<input type="checkbox"/>
3. <i>Flight controls</i>	3.	<input type="checkbox"/>	3.	<input type="checkbox"/>
4. <i>Wheels, tyres and brakes</i>	4.	<input type="checkbox"/>	4.	<input type="checkbox"/>
5. <i>Undercarriage skids/floats</i>	5.	<input type="checkbox"/>	5.	<input type="checkbox"/>
6. <i>Wheel well</i>	6.	<input type="checkbox"/>	6.	<input type="checkbox"/>

7. Powerplant and pylon.....	7.	<input type="checkbox"/>	7.	<input type="checkbox"/>
8. Fan blades, Propellers, Rotors (main & tail)	8.	<input type="checkbox"/>	8.	<input type="checkbox"/>
9. Obvious repairs	9.	<input type="checkbox"/>	9.	<input type="checkbox"/>
10. Obvious unrepaired damage	10.	<input type="checkbox"/>	10.	<input type="checkbox"/>
11. Leakage.....	11.	<input type="checkbox"/>	11.	<input type="checkbox"/>
.....		<input type="checkbox"/>		<input type="checkbox"/>
D. Cargo				
1. General condition of cargo compartment.....	1.	<input type="checkbox"/>	1.	<input type="checkbox"/>
2. Dangerous Goods.....	2.	<input type="checkbox"/>	2.	<input type="checkbox"/>
3. Stowage of cargo	3.	<input type="checkbox"/>	3.	<input type="checkbox"/>
E. General				
1. General	1.	<input type="checkbox"/>	1.	<input type="checkbox"/>

APPENDIX V**List of specific approvals***Non-commercial operations**Specialised operations*

(subject to the conditions specified in the approval and contained in the operations manual or pilot's operating handbook)

Issuing Authority ⁽¹⁾ :		
List of Specific Approvals # ⁽²⁾ :		
Name of Operator:		
Date ⁽³⁾ :		
Signature:		
Aircraft Model and Registration Marks ⁽⁴⁾ :		
Types of specialised operation (SPO), if applicable: <input type="checkbox"/> ⁽⁵⁾ ...		
Specific Approvals ⁽⁶⁾ :	Specification ⁽⁷⁾	Remarks
...		
...		
...		
...		

(1) Insertion of name and contact details.

(2) Insertion of the associated number.

(3) Issue date of the specific approvals (dd-mm-yyyy) and signature of the competent authority representative.

(4) Insertion of the Commercial Aviation Safety Team (CAST)/ICAO designation of the aircraft make, model and series, or master series, if a series has been designated (e.g. Boeing-737-3K2 or Boeing-777-232). The CAST/ICAO taxonomy is available at: <http://www.intlaviationstandards.org/>

The registration marks should be either listed in the List of Specific Approvals or in the operations manual. In the latter case the List of Specific Approvals shall refer to the related page in the operation manual.

(5) Specify the type of operation, e.g., agriculture, construction, photography, surveying, observation and patrol, aerial advertisement.

(6) List in this column any approved operations, e.g., dangerous goods, LVO, RVSM, PBN, MNPS, HOFO.

(7) List in this column the most permissive criteria for each approval, e.g. the decision height and RVR minima for CAT II.

HOFO is applicable from 01 July 2018.

APPENDIX VI

AUTHORISATION OF HIGH RISK COMMERCIAL SPECIALISED OPERATIONS	
Issuing Authority: ¹	
Authorisation no: ²	
Operator Name: ³ Operator address: ⁴ Telephone: ⁵ Fax: E-mail:	
Aircraft Model and Registration Marks: ⁶	
Authorised specialised operation: ⁷	
Authorised area or site of operation: ⁸	
Special limitations: ⁹	
This is to confirm that is authorised to perform high risk commercial specialised operation(s) in accordance with this authorisation, operator's Standard Operating Procedures, Annex IV to Regulation (EC) No 216/2008 and its Implementing Rules.	
Date of issue ¹⁰ :	Name and Signature ¹¹ : Title:

EASA FORM 151 Issue 1

1. Name and contact details of the competent authority
2. Insertion of associated authorisation number.
3. Insertion of the operator's registered name and the operator's trading name, if different. Insert "DbA" before the trading name (for "Doing business as").
4. Operator's principal place of business address.
5. Operator's principal place of business telephone and fax details, including the country code. E-mail to be provided if available.
6. Insertion of the Commercial Aviation Safety Team (CAST)/ICAO designation of the aircraft make, model and series, or master series, if a series has been designated (e.g. Boeing-737-3K2 or Boeing-777-232). The CAST/ICAO taxonomy is available at: <http://www.intlaviationstandards.org/H>.

The registration marks should be either listed in the List of Specific Approvals or in the operations manual. In the latter case the List of Specific Approvals shall refer to the related page in the operation manual.

7. Specify the type of operation, e.g., agriculture, construction, photography, surveying, observation and patrol, aerial advertisement.
8. Listing of geographical area(s) or site(s) of authorised operation (by geographical coordinates or flight information region or national or regional boundaries).
9. Listing of applicable special limitations (e.g. VFR only, Day only, etc.).
10. Issue date of the authorisation (dd-mm-yyyy).
11. Title, name and signature of the competent authority representative. In addition, an official stamp may be applied on the authorisation.

ANNEX III

Organisation Requirements for Air Operations

[PART-ORO]

ORO.GEN.005 Scope

This Annex establishes requirements to be followed by an air operator conducting:

- (a) commercial air transport operations (CAT);
- (b) commercial specialised operations;
- (c) non-commercial operations with complex motor-powered aircraft;
- (d) non-commercial specialised operations with complex motor-powered aircraft.

SUBPART GEN: GENERAL REQUIREMENTS

SECTION I *General*

ORO.GEN.105 Competent authority

For the purpose of this Annex, the competent authority exercising oversight over operators subject to a certification or declaration obligation or specialised operation authorisation shall be for operators having their principal place of business in a Member State, the authority designated by that Member State.

GM1 ORO.GEN.105 Competent authority

NON-COMMERCIAL OPERATIONS

- (a) For the determination of the principal place of business ‘activities referred to in this Part’ means those activities to which Part-ORO, Part-NCC or Part-SPO apply. For organisations that also exercise activities that are not subject to Part-ORO, Part-NCC or Part-SPO, the determination of the principal place of business should consider that part of the organisation that is responsible for the operation of aircraft subject to Part-ORO, Part-NCC or Part-SPO. For non-commercial operations, this is usually the home base of the aircraft concerned, or the location of the flight department.
- (b) For organisations that also exercise activities not subject to Part-ORO, Part-NCC or Part-SPO, the reference to the accountable manager is intended to mean the manager who has the authority to ensure that all activities subject to Part-ORO, Part-NCC or Part-SPO can be financed and carried out in accordance with the applicable requirements.

- (c) If the accountable manager is not located in that part of the organisation that is responsible for the operation of aircraft, but the majority of other management personnel are located there, the location of the accountable manager may not need to be considered for the determination of the principal place of business.

ORO.GEN.110 Operator responsibilities

- (a) The operator is responsible for the operation of the aircraft in accordance with Annex IV to Regulation (EC) No 216/2008, as applicable, the relevant requirements of this Annex and its air operator certificate (AOC) or specialised operation authorisation (SPO authorisation) or declaration.
- (b) Every flight shall be conducted in accordance with the provisions of the operations manual.
- (c) The operator shall establish and maintain a system for exercising operational control over any flight operated under the terms of its certificate, SPO authorisation or declaration.
- (d) The operator shall ensure that its aircraft are equipped and its crews are qualified as required for the area and type of operation.
- (e) The operator shall ensure that all personnel assigned to, or directly involved in, ground and flight operations are properly instructed, have demonstrated their abilities in their particular duties and are aware of their responsibilities and the relationship of such duties to the operation as a whole.
- (f) The operator shall establish procedures and instructions for the safe operation of each aircraft type, containing ground staff and crew member duties and responsibilities, for all types of operation on the ground and in flight. Those procedures and instructions shall not require crew members to perform any activities during critical phases of flight other than those required for the safe operation of the aircraft. Procedures and instructions for a sterile flight crew compartment shall also be included.
- (g) The operator shall ensure that all personnel are made aware that they shall comply with the laws, regulations and procedures of those States in which operations are conducted and that are pertinent to the performance of their duties.
- (h) The operator shall establish a checklist system for each aircraft type to be used by crew members in all phases of flight under normal, abnormal and emergency conditions to ensure that the operating procedures in the operations manual are followed. The design and utilisation of checklists shall observe human factors principles and take into account the latest relevant documentation from the aircraft manufacturer.
- (i) The operator shall specify flight planning procedures to provide for the safe conduct of the flight based on considerations of aircraft performance, other operating limitations and relevant expected conditions on the route to be followed and at the aerodromes or operating sites concerned. These procedures shall be included in the operations manual.
- (j) The operator shall establish and maintain dangerous goods training programmes for personnel as required by the technical instructions which shall be subject to review and approval by the competent authority. Training programmes shall be commensurate with the responsibilities of personnel.
- (k) Notwithstanding (j), the operator of a sailplane or a balloon or of flights taking off and landing at the same aerodrome or operating site, under VFR by day, with
 - (i) single-engined propeller-driven aeroplanes having a maximum certified take-off mass of 5 700 kg or less and a MOPSC of 5 or less; or
 - (ii) other-than complex motor-powered helicopters, single-engined, with a MOPSC of 5 or less,shall ensure that the flight crew has received an appropriate training or briefing to enable them to recognise undeclared dangerous goods brought on-board by passengers or as cargo.

AMC1 ORO.GEN.110(a) Operator responsibilities

SECURITY TRAINING PROGRAMME FOR CREW MEMBERS — CAT OPERATIONS

Without prejudice to Regulation (EC) No 300/2008, the CAT operator should establish and maintain a security training programme for crew members, including theoretical and practical elements. This training should be provided at the time of operator conversion training and thereafter at intervals not exceeding three years. The content and duration of the training should be adapted to the security threats of the individual operator and should ensure that crew members act in the most appropriate manner to minimise the consequences of acts of unlawful interference. This programme should include the following elements:

- (a) determination of the seriousness of the occurrence;
- (b) crew communication and coordination;
- (c) appropriate self-defence responses;
- (d) use of non-lethal protective devices assigned to crew members whose use is authorised by the Member State;
- (e) understanding of behaviour of terrorists so as to facilitate the ability of crew members to cope with hijacker behaviour and passenger responses;
- (f) in case where cabin crew are required, live situational training exercises regarding various threat conditions;
- (g) flight crew compartment procedures to protect the aircraft;
- (h) aircraft search procedures, in accordance with Regulation (EC) No 300/2008, including identification of prohibited articles; and
- (i) guidance on the least risk bomb locations.

AMC2 ORO.GEN.110(a) Operator responsibilities

SECURITY TRAINING PROGRAMME FOR GROUND PERSONNEL — CAT OPERATIONS

In accordance with Regulation (EC) No 300/2008, the CAT operator should establish and maintain a security training programme for ground personnel to acquaint appropriate employees with preventive measures and techniques in relation to passengers, baggage, cargo, mail, equipment, stores and supplies intended for carriage so that they contribute to the prevention of acts of sabotage or other forms of unlawful interference.

GM1 ORO.GEN.110(a) Operator responsibilities

SECURITY TRAINING PROGRAMME FOR CREW MEMBERS

ICAO Security Manual Doc 9811 (restricted access) contains guidance on the development of training programmes.

AMC1 ORO.GEN.110(c) Operator responsibilities

OPERATIONAL CONTROL

The organisation and methods established to exercise operational control should be included in the operations manual and should cover at least a description of responsibilities concerning the initiation, continuation and termination or diversion of each flight.

GM1 ORO.GEN.110(c) Operator responsibilities

OPERATIONAL CONTROL

- (a) ORO.GEN.110(c) does not imply a requirement for licensed flight dispatchers or a full flight watch system.
- (b) If the operator employs flight operations officers in conjunction with a method of operational control, training for these personnel should be based on relevant parts of ICAO Doc 7192 Training Manual, Part D-3. This training should be described in the operations manual.

AMC1 ORO.GEN.110(e) Operator responsibilities

MEL TRAINING PROGRAMME

- (a) The operator should develop a training programme for ground personnel dealing with the use of the MEL and detail such training in the continuing airworthiness maintenance exposition CAME and OM as appropriate. Such training programme should include:
 - (1) the scope, extent and use of the MEL;
 - (2) placarding of inoperative equipment;
 - (3) deferral procedures;
 - (4) dispatching; and
 - (5) any other operator's MEL related procedures.
- (b) The operator should develop a training programme for crew members and detail such training in the Operations Manual. Such training programme should include:
 - (1) the scope, extent and use of the MEL;
 - (2) the operator's MEL procedures;
 - (3) elementary maintenance procedures in accordance with Commission Regulation (EC) No 2042/2003; and
 - (4) pilot-in-command/commander responsibilities.

AMC2 ORO.GEN.110(e) Operator responsibilities

GROUND OPERATIONS WITH PASSENGERS ON BOARD IN THE ABSENCE OF FLIGHT CREW

For ground operations, whenever passengers are embarking, on board or disembarking in the absence of flight crew members, the operator should:

- (a) establish procedures to alert the aerodrome services in the event of ground emergency or urgent need; and
- (b) ensure that at least one person on board the aircraft is qualified to apply these procedures and ensure proper coordination between the aircraft and the aerodrome services.

GM1 ORO.GEN.110(e) Operator responsibilities

GROUND PERSONNEL

For the purpose of the MEL training programme referred to in AMC1 ORO.GEN.110(e) ground personnel include maintenance personnel, flight dispatchers and operations officers.

GM2 ORO.GEN.110(e) Operator responsibilities

AERODROME SERVICES

Aerodrome services refer to units available at an aerodrome that could be of assistance in responding to an urgent need or an emergency, such as rescue and firefighting services, medical and ambulance services, air traffic services, security services, police, aerodrome operations, air operators.

AMC1 ORO.GEN.110(f) Operator responsibilities

STERILE FLIGHT CREW COMPARTMENT

- (a) Sterile flight crew compartment procedures should ensure that:
- (1) flight crew activities are restricted to essential operational activities; and
 - (2) cabin crew and technical crew communications to flight crew or entry into the flight crew compartment are restricted to safety or security matters.
- (b) The sterile flight crew compartment procedures should be applied:
- (1) during critical phases of flight;
 - (2) during taxiing (aeroplanes);
 - (3) below 10 000 feet above the aerodrome of departure after take-off and the aerodrome of destination before landing, except for cruise flight; and
 - (4) during any other phases of flight as determined by the pilot-in-command or commander.
- (c) All crew members should be trained on sterile flight crew compartment procedures established by the operator, as appropriate to their duties.

GM1 ORO.GEN.110(f) Operator responsibilities

STERILE FLIGHT CREW COMPARTMENT

- (a) Establishment of procedures
- The operator should establish procedures for flight, cabin, and technical crew that emphasise the objectives and importance of the sterile flight crew compartment. These procedures should also emphasise that, during periods of time when the sterile flight deck compartment procedures are applied, cabin crew and technical crew members should call the flight crew or enter the flight crew compartment only in cases related to safety or security matters. In such cases, information should be timely and accurate.
- (b) Flight crew activities
- When sterile flight crew compartment procedures are applied, flight crew members are focused on their essential operational activities without being disturbed by non-safety related matters. Examples of activities that should not be performed are:
- (1) radio calls concerning passenger connections, fuel loads, catering, etc.;
 - (2) non-critical paperwork; and
 - (3) mass and balance corrections and performance calculations, unless required for safety reasons.
- (c) Communication to the flight crew

Cabin crew and technical crew use their own discretion to determine whether the situation is related to safety or security matters and whether to call the flight crew. Situations requiring information to the flight crew may include:

- (1) any outbreak of fire inside the cabin or in an engine;
- (2) a burning smell in the cabin or presence of smoke inside or outside;
- (3) fuel or fluid leakage;
- (4) exit door unable to be armed or disarmed;
- (5) localised extreme cabin temperature changes;
- (6) evidence of airframe icing;
- (7) cabin/galley equipment or furniture malfunction/breakage posing a hazard to the occupants;
- (8) suspicious object;
- (9) disruptive passenger;
- (10) security threat;
- (11) abnormal vibration or noise;
- (12) medical emergency;
- (13) general drop-down of the oxygen masks in the cabin; and
- (14) any other condition deemed relevant by a cabin crew or technical crew member.

AMC1 ORO.GEN.110(f)(h) Operator responsibilities

ESTABLISHMENT OF PROCEDURES

- (a) An operator should establish procedures to be followed by cabin crew covering at least:
- (1) arming and disarming of slides;
 - (2) operation of cabin lights, including emergency lighting;
 - (3) prevention and detection of cabin, oven and toilet fires;
 - (4) actions to be taken when turbulence is encountered; and
 - (5) actions to be taken in the event of an emergency and/or an evacuation.
- (b) When establishing procedures and a checklist system for cabin crew with respect to the aircraft cabin, the operator should take into account at least the following duties:

Duties	Pre-take off	In-flight	Pre-landing	Post-landing
(1) Briefing of cabin crew by the senior cabin crew member prior to commencement of a flight or series of flights	x			
(2) Check of safety and emergency equipment in accordance with operator's policies and procedures	x			

(3) Security checks as applicable	x			x
(4) Passenger embarkation and disembarkation	x			x
(5) Securing of passenger cabin (e.g. seat belts, cabin cargo/baggage)	x		x	
(6) Securing of galleys and stowage of equipment	x	if required	x	
(7) Arming of door/exit slides	x			
(8) Safety briefing/information to passengers	x	x	x	x
(9) 'Cabin secure' report to flight crew	x	if required	x	
(10) Operation of cabin lights	x	if required	x	x
(11) Cabin crew at assigned crew stations	x	if required	x	x
(12) Surveillance of passenger cabin	x	x	x	x
(13) Prevention and detection of fire in the cabin (including the combi-cargo area, crew rest areas, galleys, lavatories and any other cabin remote areas) and instructions for actions to be taken	x	x	x	x
(14) Actions to be taken when turbulence is encountered		x		
(15) Actions to be taken in case of in-flight incidents (e.g. medical emergency)		x		
(16) Actions to be taken in the event of emergency situations	x	x	x	x
(17) Disarming of door/exit slides				x
(18) Reporting of any deficiency and/or un-serviceability of equipment and/or any incident	x	x	x	x

- (c) The operator should specify the contents of safety briefings for all cabin crew members prior to the commencement of a flight or series of flights.

ORO.GEN.115 Application for an AOC

- (a) The application for an air operator certificate or an amendment to an existing certificate shall be made in a form and manner established by the competent authority, taking into account the applicable requirements of Regulation (EC) No 216/2008 and its Implementing Rules.
- (b) Applicants for an initial certificate shall provide the competent authority with documentation demonstrating how they will comply with the requirements established in Regulation (EC) No 216/2008 and its Implementing Rules. Such documentation shall include a procedure describing how changes not requiring prior approval will be managed and notified to the competent authority.

ORO.GEN.120 Means of compliance

- (a) Alternative means of compliance to those adopted by the Agency may be used by an operator to establish compliance with Regulation (EC) No 216/2008 and its Implementing Rules.
- (b) When an operator subject to certification wishes to use an alternative means of compliance to the acceptable means of compliance (AMC) adopted by the Agency to establish compliance with Regulation (EC) No 216/2008 and its Implementing Rules, it shall, prior to implementing it, provide the competent authority with a full description of the alternative means of compliance. The description shall include any revisions to manuals or procedures that may be relevant, as well as an assessment demonstrating that the Implementing Rules are met.

The operator may implement these alternative means of compliance subject to prior approval by the competent authority and upon receipt of the notification as prescribed in ARO.GEN.120(d).
- (c) An operator required to declare its activity shall notify to the competent authority the list of alternative means of compliance it uses to establish compliance with Regulation (EC) No 216/2008 and its Implementing Rules.
- (d) When an operator subject to SPO authorisation wishes to use alternative means of compliance, it shall comply with (b) whenever such alternative means of compliance affects the standard operating procedures that are part of the authorisation and with (c) for the declared part of its organisation and operation.

AMC1 ORO.GEN.120(a) Means of compliance**DEMONSTRATION OF COMPLIANCE**

In order to demonstrate that the Implementing Rules are met, a risk assessment should be completed and documented. The result of this risk assessment should demonstrate that an equivalent level of safety to that established by the Acceptable Means of Compliance (AMC) adopted by the Agency is reached.

ORO.GEN.125 Terms of approval and privileges of an AOC holder

A certified operator shall comply with the scope and privileges defined in the operations specifications attached to the operator's certificate.

AMC1 ORO.GEN.125 Terms of approval and privileges of an AOC holder**MANAGEMENT SYSTEM DOCUMENTATION**

The management system documentation should contain the privileges and detailed scope of activities for which the operator is certified, as relevant to the applicable requirements. The scope of activities defined in the management system documentation should be consistent with the terms of approval.

ORO.GEN.130 Changes related to an AOC holder

- (a) Any change affecting:
- (1) the scope of the certificate or the operations specifications of an operator; or
 - (2) any of the elements of the operator's management system as required in ORO.GEN.200(a)(1) and (a)(2),
- shall require prior approval by the competent authority.
- (b) For any changes requiring prior approval in accordance with Regulation (EC) No 216/2008 and its Implementing Rules, the operator shall apply for and obtain an approval issued by the competent authority. The application shall be submitted before any such change takes place, in order to enable the competent authority to determine continued compliance with Regulation (EC) No 216/2008 and its Implementing Rules and to amend, if necessary, the operator certificate and related terms of approval attached to it.
- The operator shall provide the competent authority with any relevant documentation.
- The change shall only be implemented upon receipt of formal approval by the competent authority in accordance with ARO.GEN.330.
- The operator shall operate under the conditions prescribed by the competent authority during such changes, as applicable.
- (c) All changes not requiring prior approval shall be managed and notified to the competent authority as defined in the procedure approved by the competent authority in accordance with ARO.GEN.310(c).

AMC1 ORO.GEN.130 Changes related to an AOC holder

APPLICATION TIME FRAMES

- (a) The application for the amendment of an air operator certificate (AOC) should be submitted at least 30 days before the date of the intended changes.
- (b) In the case of a planned change of a nominated person, the operator should inform the competent authority at least 10 days before the date of the proposed change.
- (c) Unforeseen changes should be notified at the earliest opportunity, in order to enable the competent authority to determine continued compliance with the applicable requirements and to amend, if necessary, the AOC and related terms of approval.

GM1 ORO.GEN.130(a) Changes related to an AOC holder

GENERAL

- (a) Typical examples of changes that may affect the AOC or the operations specifications or the operator's management system, as required in ORO.GEN.200 (a)(1) and (a)(2), are listed below:
- (1) the name of the operator;
 - (2) a change of legal entity;
 - (3) the operator's principal place of business;
 - (4) the operator's scope of activities;
 - (5) additional locations of the operator;

- (6) the accountable manager;
 - (7) any of the persons referred to in ORO.GEN.210 (a) and (b);
 - (8) the operator's documentation, as required by this Annex, safety policy and procedures;
 - (9) the facilities.
- (b) Prior approval by the competent authority is required for any changes to the operator's procedure describing how changes not requiring prior approval will be managed and notified to the competent authority.
- (c) Changes requiring prior approval may only be implemented upon receipt of formal approval by the competent authority.

GM2 ORO.GEN.130(a) Changes related to an AOC holder

CHANGE OF NAME

A change of name requires the operator to submit a new application as a matter of urgency.

Where this is the only change to report, the new application can be accompanied by a copy of the documentation previously submitted to the competent authority under the previous name, as a means of demonstrating how the operator complies with the applicable requirements.

GM3 ORO.GEN.130(b) Changes related to an AOC holder

CHANGES REQUIRING PRIOR APPROVAL

The following GM is a non-exhaustive checklist of items that require prior approval from the competent authority as specified in the applicable Implementing Rules:

- (a) alternative means of compliance;
- (b) procedures regarding items to be notified to the competent authority;
- (c) cabin crew:
 - (1) evacuation procedures with a reduced number of required cabin crew during ground operations or in unforeseen circumstances;
 - (2) conduct of the training, examination and checking required by Annex V (Part-CC) to Commission Regulation (EU) No 290/2012¹ and issue of cabin crew attestations;
 - (3) procedures for cabin crew to operate on four aircraft types;
 - (4) training programmes, including syllabi;
- (d) leasing agreements;
- (e) non-commercial operations by AOC holders;
- (f) specific approvals in accordance with Annex V (Part-SPA);
- (g) dangerous goods training programmes;

¹ Commission Regulation (EU) No 290/2012 of 30 March 2012 amending Commission Regulation (EU) No 1178/2011 laying down technical requirements and administrative procedures related to civil aviation aircrew pursuant to Regulation (EC) No 216/2008 of the European Parliament and of the Council.

-
- (h) flight crew:
 - (1) alternative training and qualification programmes (ATQPs);
 - (2) procedures for flight crew to operate on more than one type or variant;
 - (3) training and checking programmes, including syllabi and use of flight simulation training devices (FSTDs);
 - (i) fuel policy;
 - (j) helicopter operations:
 - (1) airborne radar approaches;
 - (2) over a hostile environment located outside a congested area, unless the operator holds an approval to operate according to Subpart J of Annex V (SPA.HEMS);
 - (3) procedures for selecting off-shore alternates;
 - (4) to/from a public interest site;
 - (5) without an assured safe forced landing capability;
 - (k) mass and balance:
 - (1) standard masses for load items other than standard masses for passengers and checked baggage;
 - (2) use of on-board mass and balance computer systems;
 - (l) minimum equipment list (MEL):
 - (1) MEL;
 - (2) operating other than in accordance with the MEL, but within the constraints of the master minimum equipment list (MMEL);
 - (3) rectification interval extension (RIE) procedures;
 - (m) minimum flight altitudes:
 - (1) the method for establishing minimum flight altitudes;
 - (2) descent procedures to fly below specified minimum altitudes;
 - (n) performance:
 - (1) increased bank angles at take-off (for performance class A aeroplanes);
 - (2) short landing operations (for performance class A and B aeroplanes);
 - (3) steep approach operations (for performance class A and B aeroplanes);
 - (o) isolated aerodrome: using an isolated aerodrome as destination aerodrome for operations with aeroplanes;
 - (p) approach flight technique:
 - (1) all approaches not flown as stabilised approaches for a particular approach to a particular runway;
 - (2) non-precision approaches not flown with the continuous descent final approach (CDFA) technique for each particular approach/runway combination;
 - (q) maximum distance from an adequate aerodrome for two-engined aeroplanes without an extended range operations with two-engined aeroplanes (ETOPS) approval:

-
- (1) air operations with two-engined performance class A aeroplanes with a maximum operational passenger seating configuration (MOPSC) of 19 or less and a maximum take-off mass less than 45 360 kg, over a route that contains a point further than 120 minutes from an adequate aerodrome, under standard conditions in still air;
 - (r) aircraft categories:
 - (1) Applying a lower landing mass than the maximum certified landing mass for determining the indicated airspeed at threshold (VAT).

ORO.GEN.135 Continued validity of an AOC

- (a) The operator's certificate shall remain valid subject to:
- (1) the operator remaining in compliance with the relevant requirements of Regulation (EC) No 216/2008 and its Implementing Rules, taking into account the provisions related to the handling of findings as specified under ORO.GEN.150;
 - (2) the competent authority being granted access to the operator as defined in ORO.GEN.140 to determine continued compliance with the relevant requirements of Regulation (EC) No 216/2008 and its Implementing Rules; and
 - (3) the certificate not being surrendered or revoked.
- (b) Upon revocation or surrender the certificate shall be returned to the competent authority without delay.

ORO.GEN.140 Access

- (a) For the purpose of determining compliance with the relevant requirements of Regulation (EC) No 216/2008 and its Implementing Rules, the operator shall grant access at any time to any facility, aircraft, document, records, data, procedures or any other material relevant to its activity subject to certification, SPO authorisation or declaration, whether it is contracted or not, to any person authorised by one of the following authorities:
- (1) the competent authority defined in ORO.GEN.105;
 - (2) the authority acting under the provisions of ARO.GEN.300(d), ARO.GEN.300(e) or ARO.RAMP.
- (b) Access to the aircraft mentioned under (a) shall, in the case of CAT, include the possibility to enter and remain in the aircraft during flight operations unless otherwise decided by the commander for the flight crew compartment in accordance with CAT.GEN.MPA.135 in the interest of safety.

ORO.GEN.150 Findings

After receipt of notification of findings, the operator shall:

- (a) identify the root cause of the non-compliance;
- (b) define a corrective action plan; and
- (c) demonstrate corrective action implementation to the satisfaction of the competent authority within a period agreed with that authority as defined in ARO.GEN.350(d).

AMC1 ORO.GEN.150(b) Findings**GENERAL**

The corrective action plan defined by the operator should address the effects of the non-compliance, as well as its root cause.

GM1 ORO.GEN.150 Findings

GENERAL

- (a) Preventive action is the action to eliminate the cause of a potential non-compliance or other undesirable potential situation.
- (b) Corrective action is the action to eliminate or mitigate the root cause(s) and prevent recurrence of an existing detected non-compliance or other undesirable condition or situation. Proper determination of the root cause is crucial for defining effective corrective actions to prevent reoccurrence.
- (c) Correction is the action to eliminate a detected non-compliance.

ORO.GEN.155 Immediate reaction to a safety problem

The operator shall implement:

- (a) any safety measures mandated by the competent authority in accordance with ARO.GEN.135(c); and
- (b) any relevant mandatory safety information issued by the Agency, including airworthiness directives.

ORO.GEN.160 Occurrence reporting

- (a) The operator shall report to the competent authority, and to any other organisation required by the State of the operator to be informed, any accident, serious incident and occurrence as defined in Regulation (EU) No 996/2010 of the European Parliament and of the Council² and Directive 2003/42/EC.
- (b) Without prejudice to point (a) the operator shall report to the competent authority and to the organisation responsible for the design of the aircraft any incident, malfunction, technical defect, exceeding of technical limitations or occurrence that would highlight inaccurate, incomplete or ambiguous information contained in the operational suitability data established in accordance with Regulation (EU) No 748/2012 or other irregular circumstance that has or may have endangered the safe operation of the aircraft and that has not resulted in an accident or serious incident.
- (c) Without prejudice to Regulation (EU) No 996/2010, Directive 2003/42/EC, Commission Regulation (EC) No 1321/2007³ and Commission Regulation (EC) No 1330/2007⁴, the reports referred in paragraphs (a) and (b) shall be made in a form and manner established by the competent authority and contain all pertinent information about the condition known to the operator.
- (d) Reports shall be made as soon as practicable, but in any case within 72 hours of the operator identifying the condition to which the report relates, unless exceptional circumstances prevent this.
- (e) Where relevant, the operator shall produce a follow-up report to provide details of actions it intends to take to prevent similar occurrences in the future, as soon as these actions have been identified. This report shall be produced in a form and manner established by the competent authority.

AMC1 ORO.GEN.160 Occurrence reporting

GENERAL

- (a) The operator should report all occurrences defined in AMC 20-8, and as required by the applicable national rules implementing Directive 2003/42/EC⁵ on occurrence reporting in civil aviation.
- (b) In addition to the reports required by AMC 20-8 and Directive 2003/42/EC, the operator should report volcanic ash clouds encountered during flight.

² OJ L 295, 12.11.2010, p. 35.

³ OJ L 294, 13.11.2007, p. 3.

⁴ OJ L 295, 14.11.2007, p. 7.

⁵ Directive 2003/42/EC of the European Parliament and of the Council of 13 June 2003 on occurrence reporting in civil aviation (OJ L 167, 4.7.2003, p. 23–36).

AMC2 ORO.GEN.160 Occurrence reporting

REPORTABLE EVENTS OF PBN OPERATIONS

- (a) A reportable event should be an event that adversely affects the safety of the operation and may be caused by actions or events external to the functioning of the aircraft navigation system.
- (b) Technical defects and the exceedance of technical limitations, including:
 - (1) significant navigation errors attributed to incorrect data or a database coding error;
 - (2) unexpected deviations in lateral/vertical flight path not caused by flight crew input or erroneous operation of equipment;
 - (3) significant misleading information without a failure warning;
 - (4) total loss or multiple navigation equipment failure; and
 - (5) loss of integrity, e.g. RAIM function, whereas integrity was predicted to be available during preflight planning,should be considered a reportable event.
- (c) The operator should have in place a system for investigating a reportable event to determine if it is due to an improperly coded procedure or a navigation database error. The operator should initiate corrective actions for such an event.

SECTION 2
Management**ORO.GEN.200 Management system**

- (a) The operator shall establish, implement and maintain a management system that includes:
- (1) clearly defined lines of responsibility and accountability throughout the operator, including a direct safety accountability of the accountable manager;
 - (2) a description of the overall philosophies and principles of the operator with regard to safety, referred to as the safety policy;
 - (3) the identification of aviation safety hazards entailed by the activities of the operator, their evaluation and the management of associated risks, including taking actions to mitigate the risk and verify their effectiveness;
 - (4) maintaining personnel trained and competent to perform their tasks;
 - (5) documentation of all management system key processes, including a process for making personnel aware of their responsibilities and the procedure for amending this documentation;
 - (6) a function to monitor compliance of the operator with the relevant requirements. Compliance monitoring shall include a feedback system of findings to the accountable manager to ensure effective implementation of corrective actions as necessary; and
 - (7) any additional requirements that are prescribed in the relevant Subparts of this Annex or other applicable Annexes.
- (b) The management system shall correspond to the size of the operator and the nature and complexity of its activities, taking into account the hazards and associated risks inherent in these activities.

AMC1 ORO.GEN.200(a)(1);(2);(3);(5) Management system**NON-COMPLEX OPERATORS — GENERAL**

- (a) Safety risk management may be performed using hazard checklists or similar risk management tools or processes, which are integrated into the activities of the operator.
- (b) The operator should manage safety risks related to a change. The management of change should be a documented process to identify external and internal change that may have an adverse effect on safety. It should make use of the operator's existing hazard identification, risk assessment and mitigation processes.
- (c) The operator should identify a person who fulfils the role of safety manager and who is responsible for coordinating the safety management system. This person may be the accountable manager or a person with an operational role within the operator.
- (d) Within the operator, responsibilities should be identified for hazard identification, risk assessment and mitigation.
- (e) The safety policy should include a commitment to improve towards the highest safety standards, comply with all applicable legal requirements, meet all applicable standards, consider best practices and provide appropriate resources.

- (f) The operator should, in cooperation with other stakeholders, develop, coordinate and maintain an emergency response plan (ERP) that ensures orderly and safe transition from normal to emergency operations and return to normal operations. The ERP should provide the actions to be taken by the operator or specified individuals in an emergency and reflect the size, nature and complexity of the activities performed by the operator.

AMC1 ORO.GEN.200(a)(1) Management system

COMPLEX OPERATORS — ORGANISATION AND ACCOUNTABILITIES

The management system of an operator should encompass safety by including a safety manager and a safety review board in the organisational structure.

- (a) Safety manager
- (1) The safety manager should act as the focal point and be responsible for the development, administration and maintenance of an effective safety management system.
 - (2) The functions of the safety manager should be to:
 - (i) facilitate hazard identification, risk analysis and management;
 - (ii) monitor the implementation of actions taken to mitigate risks, as listed in the safety action plan;
 - (iii) provide periodic reports on safety performance;
 - (iv) ensure maintenance of safety management documentation;
 - (v) ensure that there is safety management training available and that it meets acceptable standards;
 - (vi) provide advice on safety matters; and
 - (vii) ensure initiation and follow-up of internal occurrence/accident investigations.
- (b) Safety review board
- (1) The safety review board should be a high level committee that considers matters of strategic safety in support of the accountable manager's safety accountability.
 - (2) The board should be chaired by the accountable manager and be composed of heads of functional areas.
 - (3) The safety review board should monitor:
 - (i) safety performance against the safety policy and objectives;
 - (ii) that any safety action is taken in a timely manner; and
 - (iii) the effectiveness of the operator's safety management processes.
- (c) The safety review board should ensure that appropriate resources are allocated to achieve the established safety performance.
- (d) The safety manager or any other relevant person may attend, as appropriate, safety review board meetings. He/she may communicate to the accountable manager all information, as necessary, to allow decision making based on safety data.

GM1 ORO.GEN.200(a)(1) Management system

SAFETY MANAGER

- (a) Depending on the size of the operator and the nature and complexity of its activities, the safety manager may be assisted by additional safety personnel for the performance of all safety management related tasks.
- (b) Regardless of the organisational set-up it is important that the safety manager remains the unique focal point as regards the development, administration and maintenance of the operator's safety management system.

GM2 ORO.GEN.200(a)(1) Management system

COMPLEX OPERATORS — SAFETY ACTION GROUP

- (a) A safety action group may be established as a standing group or as an ad-hoc group to assist or act on behalf of the safety review board.
- (b) More than one safety action group may be established depending on the scope of the task and specific expertise required.
- (c) The safety action group should report to and take strategic direction from the safety review board and should be comprised of managers, supervisors and personnel from operational areas.
- (d) The safety action group should:
 - (1) monitor operational safety;
 - (2) resolve identified risks;
 - (3) assess the impact on safety of operational changes; and
 - (4) ensure that safety actions are implemented within agreed timescales.
- (e) The safety action group should review the effectiveness of previous safety recommendations and safety promotion.

AMC1 ORO.GEN.200(a)(2) Management system

COMPLEX OPERATORS — SAFETY POLICY

- (a) The safety policy should:
 - (1) be endorsed by the accountable manager;
 - (2) reflect organisational commitments regarding safety and its proactive and systematic management;
 - (3) be communicated, with visible endorsement, throughout the operator; and
 - (4) include safety reporting principles.
- (b) The safety policy should include a commitment:
 - (1) to improve towards the highest safety standards;
 - (2) to comply with all applicable legislation, meet all applicable standards and consider best practices;
 - (3) to provide appropriate resources;
 - (4) to enforce safety as one primary responsibility of all managers; and

- (5) not to blame someone for reporting something which would not have been otherwise detected.
- (c) Senior management should:
 - (1) continually promote the safety policy to all personnel and demonstrate their commitment to it;
 - (2) provide necessary human and financial resources for its implementation; and
 - (3) establish safety objectives and performance standards.

GM1 ORO.GEN.200(a)(2) Management system

SAFETY POLICY

The safety policy is the means whereby the operator states its intention to maintain and, where practicable, improve safety levels in all its activities and to minimise its contribution to the risk of an aircraft accident as far as is reasonably practicable.

The safety policy should state that the purpose of safety reporting and internal investigations is to improve safety, not to apportion blame to individuals.

AMC1 ORO.GEN.200(a)(3) Management system

COMPLEX OPERATORS — SAFETY RISK MANAGEMENT

- (a) Hazard identification processes
 - (1) Reactive and proactive schemes for hazard identification should be the formal means of collecting, recording, analysing, acting on and generating feedback about hazards and the associated risks that affect the safety of the operational activities of the operator.
 - (2) All reporting systems, including confidential reporting schemes, should include an effective feedback process.
- (b) Risk assessment and mitigation processes
 - (1) A formal risk management process should be developed and maintained that ensures analysis (in terms of likelihood and severity of occurrence), assessment (in terms of tolerability) and control (in terms of mitigation) of risks to an acceptable level.
 - (2) The levels of management who have the authority to make decisions regarding the tolerability of safety risks, in accordance with (b)(1), should be specified.
- (c) Internal safety investigation
 - (1) The scope of internal safety investigations should extend beyond the scope of occurrences required to be reported to the competent authority.
- (d) Safety performance monitoring and measurement
 - (1) Safety performance monitoring and measurement should be the process by which the safety performance of the operator is verified in comparison to the safety policy and objectives.
 - (2) This process should include:
 - (i) safety reporting, addressing also the status of compliance with the applicable requirements;

- (ii) safety studies, that is, rather large analyses encompassing broad safety concerns;
 - (iii) safety reviews including trends reviews, which would be conducted during introduction and deployment of new technologies, change or implementation of procedures, or in situations of structural change in operations;
 - (iv) safety audits focussing on the integrity of the operator's management system, and periodically assessing the status of safety risk controls; and
 - (v) safety surveys, examining particular elements or procedures of a specific operation, such as problem areas or bottlenecks in daily operations, perceptions and opinions of operational personnel and areas of dissent or confusion.
- (e) The management of change
- The operator should manage safety risks related to a change. The management of change should be a documented process to identify external and internal change that may have an adverse effect on safety. It should make use of the operator's existing hazard identification, risk assessment and mitigation processes.
- (f) Continuous improvement
- The operator should continuously seek to improve its safety performance. Continuous improvement should be achieved through:
- (1) proactive and reactive evaluations of facilities, equipment, documentation and procedures through safety audits and surveys;
 - (2) proactive evaluation of individuals' performance to verify the fulfilment of their safety responsibilities; and
 - (3) reactive evaluations in order to verify the effectiveness of the system for control and mitigation of risk.
- (g) The emergency response plan (ERP)
- (1) An ERP should be established that provides the actions to be taken by the operator or specified individuals in an emergency. The ERP should reflect the size, nature and complexity of the activities performed by the operator.
 - (2) The ERP should ensure:
 - (i) an orderly and safe transition from normal to emergency operations;
 - (ii) safe continuation of operations or return to normal operations as soon as practicable; and
 - (iii) coordination with the emergency response plans of other organisations, where appropriate.

GM1 ORO.GEN.200(a)(3) Management system

INTERNAL OCCURRENCE REPORTING SCHEME

- (a) The overall purpose of the scheme is to use reported information to improve the level of safety performance of the operator and not to attribute blame.
- (b) The objectives of the scheme are to:

- (1) enable an assessment to be made of the safety implications of each relevant incident and accident, including previous similar occurrences, so that any necessary action can be initiated; and
 - (2) ensure that knowledge of relevant incidents and accidents is disseminated, so that other persons and operators may learn from them.
- (c) The scheme is an essential part of the overall monitoring function and it is complementary to the normal day-to-day procedures and ‘control’ systems and is not intended to duplicate or supersede any of them. The scheme is a tool to identify those instances where routine procedures have failed.
- (d) All occurrence reports judged reportable by the person submitting the report should be retained as the significance of such reports may only become obvious at a later date.

GM2 ORO.GEN.200(a)(3) Management system

RISK MANAGEMENT OF FLIGHT OPERATIONS WITH KNOWN OR FORECAST VOLCANIC ASH CONTAMINATION

(a) Responsibilities

The operator is responsible for the safety of its operations, including within an area with known or forecast volcanic ash contamination.

The operator should complete this assessment of safety risks related to known or forecast volcanic ash contamination as part of its management system before initiating operations into airspace forecast to be or aerodromes/operating sites known to be contaminated with volcanic ash.

This process is intended to ensure the operator takes account of the likely accuracy and quality of the information sources it uses in its management system and to demonstrate its own competence and capability to interpret data from different sources in order to achieve the necessary level of data integrity reliably and correctly resolve any conflicts among data sources that may arise.

In order to decide whether or not to operate into airspace forecast to be or aerodromes/operating sites known to be contaminated with volcanic ash, the operator should make use of the safety risk assessment within its management system, as required by ORO.GEN.200.

The operator’s safety risk assessment should take into account all relevant data including data from the type certificate holders (TCHs) regarding the susceptibility of the aircraft they operate to volcanic cloud-related airworthiness effects, the nature and severity of these effects and the related pre-flight, in-flight and post-flight precautions to be observed by the operator.

The operator should ensure that personnel required to be familiar with the details of the safety risk assessments receives all relevant information (both pre-flight and in-flight) in order to be in a position to apply appropriate mitigation measures as specified by the safety risk assessments.

(b) Procedures

The operator should have documented procedures for the management of operations into airspace forecast to be or aerodromes/operating sites known to be contaminated with volcanic ash.

These procedures should ensure that, at all times, flight operations remain within the accepted safety boundaries as established through the management system allowing for any variations in

information sources, equipment, operational experience or organisation. Procedures should include those for flight crew, flight planners, dispatchers, operations, continuing airworthiness personnel such that they are in a position to evaluate correctly the risk of flights into airspace forecast to be contaminated by volcanic ash and to plan accordingly.

Continuing airworthiness personnel should be provided with procedures allowing them to correctly assess the need for and to execute relevant continuing airworthiness interventions.

The operator should retain sufficient qualified and competent staff to generate well supported operational risk management decisions and ensure that its staff are appropriately trained and current. It is recommended that the operator make the necessary arrangements for its relevant staff to take up opportunities to be involved in volcanic ash exercises conducted in their areas of operation.

(c) Volcanic activity information and operator's potential response

Before and during operations, information valuable to the operator is generated by various volcano agencies worldwide. The operator's risk assessment and mitigating actions need to take account of, and respond appropriately to, the information likely to be available during each phase of the eruptive sequence from pre-eruption through to end of eruptive activity. It is nevertheless noted that eruptions rarely follow a deterministic pattern of behaviour. A typical operator's response may consist of the following:

(1) Pre-eruption

The operator should have in place a robust mechanism for ensuring that it is constantly vigilant for any alerts of pre-eruption volcanic activity relevant to its operations. The staff involved need to understand the threat to safe operations that such alerts represent.

An operator whose routes traverse large, active volcanic areas for which immediate International Airways Volcano Watch (IAVW) alerts may not be available, should define its strategy for capturing information about increased volcanic activity before pre-eruption alerts are generated. For example, an operator may combine elevated activity information with information concerning the profile and history of the volcano to determine an operating policy, which could include re-routing or restrictions at night. This would be useful when dealing with the 60% of volcanoes which are unmonitored.

Such an operator should also ensure that its crews are aware that they may be the first to observe an eruption and so need to be vigilant and ready to ensure that this information is made available for wider dissemination as quickly as possible.

(2) Start of an eruption

Given the likely uncertainty regarding the status of the eruption during the early stages of an event and regarding the associated volcanic cloud, the operator's procedures should include a requirement for crews to initiate re-routes to avoid the affected airspace.

The operator should ensure that flights are planned to remain clear of the affected areas and that consideration is given to available aerodromes/operating sites and fuel requirements.

It is expected that the following initial actions will be taken by the operator:

- (i) determine if any aircraft in flight could be affected, alert the crew and provide advice on re-routing and available aerodromes/operating sites as required;
- (ii) alert management;

- (iii) for flight departures, brief flight crew and revise flight and fuel planning in accordance with the safety risk assessment;
 - (iv) alert flight crew and operations staff to the need for increased monitoring of information (e.g. special air report (AIREP), volcanic activity report (VAR), significant weather information (SIGMET), NOTAMs and company messages);
 - (v) initiate the gathering of all data relevant to determining the risk; and
 - (vi) apply mitigations identified in the safety risk assessment.
- (3) On-going eruption

As the eruptive event develops, the operator can expect the responsible Volcanic Ash Advisory Centre (VAAC) to provide volcanic ash advisory messages (VAA/VAGs) defining, as accurately as possible, the vertical and horizontal extent of areas and layers of volcanic clouds. As a minimum, the operator should monitor, and take account of, this VAAC information as well as of relevant SIGMETs and NOTAMs.

Other sources of information are likely to be available such as VAR/AIREPs, satellite imagery and a range of other information from State and commercial organisations. The operator should plan its operations in accordance with its safety risk assessment taking into account the information that it considers accurate and relevant from these additional sources.

The operator should carefully consider and resolve differences or conflicts among the information sources, notably between published information and observations (pilot reports, airborne measurements, etc.).

Given the dynamic nature of the volcanic hazards, the operator should ensure that the situation is monitored closely and operations adjusted to suit changing conditions.

The operator should be aware that the affected or danger areas may be established and presented in a different way than the one currently used in Europe, as described in EUR Doc 019-NAT Doc 006.

The operator should require reports from its crews concerning any encounters with volcanic emissions. These reports should be passed immediately to the appropriate air traffic services (ATS) unit and to the operator's competent authority.

For the purpose of flight planning, the operator should treat the horizontal and vertical limits of the temporary danger area (TDA) or airspace forecast to be contaminated by volcanic ash as applicable, to be overflowed as it would mountainous terrain, modified in accordance with its safety risk assessment. The operator should take account of the risk of cabin depressurisation or engine failure resulting in the inability to maintain level flight above a volcanic cloud, especially when conducting ETOPS operations. Additionally, minimum equipment list (MEL) provisions should be considered in consultation with the TCHs.

Flying below volcanic ash contaminated airspace should be considered on a case-by-case basis. It should only be planned to reach or leave an aerodrome/operating site close to the boundary of this airspace or where the ash contamination is very high and stable. The establishment of Minimum Sector Altitude (MSA) and the availability of aerodromes/operating sites should be considered.

- (d) Safety risk assessment

When directed specifically at the issue of intended flight into airspace forecast to be or aerodromes/operating sites known to be contaminated with volcanic ash, the process should involve the following:

(1) Identifying the hazards

The generic hazard, in the context of this document, is airspace forecast to be or aerodromes/operating sites known to be contaminated with volcanic ash, and whose characteristics are harmful to the airworthiness and operation of the aircraft.

This GM is referring to volcanic ash contamination since it is the most significant hazard for flight operations in the context of a volcanic eruption. Nevertheless, it might not be the only hazard and therefore the operator should consider additional hazards which could have an adverse effect on aircraft structure or passengers safety such as gases.

Within this generic hazard, the operator should develop its own list of specific hazards taking into account its specific aircraft, experience, knowledge and type of operation, and any other relevant data stemming from previous eruptions.

(2) Considering the severity and consequences of the hazard occurring (i.e. the nature and actual level of damage expected to be inflicted on the particular aircraft from exposure to that volcanic ash cloud).

(3) Evaluating the likelihood of encountering volcanic ash clouds with characteristics harmful to the safe operation of the aircraft.

For each specific hazard within the generic hazard, the likelihood of adverse consequences should be assessed, either qualitatively or quantitatively.

(4) Determining whether the consequent risk is acceptable and within the operator's risk performance criteria.

At this stage of the process, the safety risks should be classified as acceptable or unacceptable. The assessment of tolerability will be subjective, based on qualitative data and expert judgement, until specific quantitative data are available in respect of a range of parameters.

(5) Taking action to reduce the safety risk to a level that is acceptable to the operator's management.

Appropriate mitigation for each unacceptable risk identified should then be considered in order to reduce the risk to a level acceptable to the operator's management.

(e) Procedures to be considered when identifying possible mitigations actions

When conducting a volcanic ash safety risk assessment, the operator should consider the following non-exhaustive list of procedures and processes as mitigation:

(1) Type certificate holders

Obtaining advice from the TCHs and other engineering sources concerning operations in potentially contaminated airspace and/or aerodromes/operating sites contaminated by volcanic ash.

This advice should set out:

- (i) the features of the aircraft that are susceptible to airworthiness effects related to volcanic ash;
- (ii) the nature and severity of these effects;

- (iii) the effect of volcanic ash on operations to/from contaminated aerodromes/operating sites, including the effect on take-off and landing aircraft performance;
 - (iv) the related pre-flight, in-flight and post-flight precautions to be observed by the operator including any necessary amendments to aircraft operating manuals, aircraft maintenance manuals, master minimum equipment list/dispatch deviation or equivalents; and
 - (v) the recommended inspections associated with operations in volcanic ash potentially contaminated airspace and operations to/from volcanic ash contaminated aerodromes/operating sites; this may take the form of instructions for continuing airworthiness or other advice.
- (2) Operator/contracted organisations' personnel
- Definition of procedures for flight planning, operations, engineering and maintenance ensuring that:
- (i) personnel responsible for flight planning are in a position to evaluate correctly the risk of encountering volcanic ash contaminated airspace, or aerodromes/operating sites, and can plan accordingly;
 - (ii) flight planning and operational procedures enable crews to avoid areas and aerodromes/operating sites with unacceptable volcanic ash contamination;
 - (iii) flight crew are aware of the possible signs of entry into a volcanic ash cloud and execute the associated procedures;
 - (iv) continuing airworthiness personnel are able to assess the need for and to execute any necessary maintenance or other required interventions; and
 - (v) crews are provided with appropriate aircraft performance data when operating to/from aerodromes/operating sites contaminated with volcanic ash.
- (3) Provision of enhanced flight watch
- This should ensure:
- (i) close and continuous monitoring of VAA, VAR/AIREP, SIGMET, NOTAM, ASHTAM and other relevant information, and information from crews, concerning the volcanic ash cloud hazard;
 - (ii) access to plots of the affected areas from SIGMETs, NOTAMs and relevant company information for crews and personnel responsible for the management and the supervision of the flight operations; and
 - (iii) communication of the latest information to crews and personnel responsible for the management and the supervision of the flight operations in a timely fashion.
- (4) Flight planning
- Flexibility of the process to allow re-planning at short notice should conditions change.
- (5) Departure, destination and alternate aerodromes
- For the airspace to be traversed, or the aerodromes/operating sites in use, parameters to evaluate and take account of:
- (i) the probability of contamination;
 - (ii) any additional aircraft performance requirements;

- (iii) required maintenance considerations;
 - (iv) fuel requirements for re-routeing and extended holding.
- (6) Routing policy
- Parameters to evaluate and take account of:
- (i) the shortest period in and over the forecast contaminated area;
 - (ii) the hazards associated with flying over the contaminated area;
 - (iii) drift down and emergency descent considerations;
 - (iv) the policy for flying below the contaminated airspace and the associated hazards.
- (7) Diversion policy
- Parameters to evaluate and take account of:
- (i) maximum allowed distance from a suitable aerodrome/operating site;
 - (ii) availability of aerodromes/operating sites outside the forecast contaminated area;
 - (iii) diversion policy after an volcanic ash encounter.
- (8) Minimum equipment list (MEL)
- Additional provisions in the MEL for dispatching aircraft with unserviceabilities that might affect the following non-exhaustive list of systems:
- (i) air conditioning packs;
 - (ii) engine bleeds;
 - (iii) pressurisation system;
 - (iv) electrical power distribution system;
 - (v) air data system;
 - (vi) standby instruments;
 - (vii) navigation systems;
 - (viii) de-icing systems;
 - (ix) engine-driven generators;
 - (x) auxiliary power unit (APU);
 - (xi) airborne collision avoidance system (ACAS);
 - (xii) terrain awareness warning system (TAWS);
 - (xiii) autoland systems;
 - (xiv) provision of crew oxygen;
 - (xv) supplemental oxygen for passengers.
- (9) Standard operating procedures
- Crew training to ensure they are familiar with normal and abnormal operating procedures and particularly any changes regarding but not limited to:
- (i) pre-flight planning;
 - (ii) in-flight monitoring of volcanic ash cloud affected areas and avoidance procedures;

- (iii) diversion;
 - (iv) communications with ATC;
 - (v) in-flight monitoring of engine and systems potentially affected by volcanic ash cloud contamination;
 - (vi) recognition and detection of volcanic ash clouds and reporting procedures;
 - (vii) in-flight indications of a volcanic ash cloud encounter;
 - (viii) procedures to be followed if a volcanic ash cloud is encountered;
 - (ix) unreliable or erroneous airspeed;
 - (x) non-normal procedures for engines and systems potentially affected by volcanic ash cloud contamination;
 - (xi) engine-out and engine relight;
 - (xii) escape routes; and
 - (xiii) operations to/from aerodromes/operating sites contaminated with volcanic ash.
- (10) Provision for aircraft technical log
- This should ensure:
- (i) systematic entry in the aircraft technical log related to any actual or suspected volcanic ash encounter whether in-flight or at an aerodrome/operating site; and
 - (ii) checking, prior to flight, of the completion of maintenance actions related to an entry in the aircraft technical log for a volcanic ash cloud encounter on a previous flight.
- (11) Incident reporting
- Crew requirements for:
- (i) reporting an airborne volcanic ash cloud encounter (VAR);
 - (ii) post-flight volcanic ash cloud reporting (VAR);
 - (iii) reporting non-encounters in airspace forecast to be contaminated; and
 - (iv) filing a mandatory occurrence report in accordance with ORO.GEN.160.
- (12) Continuing airworthiness procedures
- Procedures when operating in or near areas of volcanic ash cloud contamination:
- (i) enhancement of vigilance during inspections and regular maintenance and appropriate adjustments to maintenance practices;
 - (ii) definition of a follow-up procedure when a volcanic ash cloud encounter has been reported or suspected;
 - (iii) thorough investigation for any sign of unusual or accelerated abrasions or corrosion or of volcanic ash accumulation;
 - (iv) reporting to TCHs and the relevant authorities observations and experiences from operations in areas of volcanic ash cloud contamination;
 - (v) completion of any additional maintenance recommended by the TCH or by the Competent Authority.

(f) Reporting

The operator should ensure that reports are immediately submitted to the nearest ATS unit using the VAR/AIREP procedures followed up by a more detailed VAR on landing together with, as applicable, a report, as defined in Commission Regulation (EU) No 996/2010 and Directive 2003/42/EC, and an aircraft technical log entry for:

- (1) any incident related to volcanic clouds;
- (2) any observation of volcanic ash activity; and
- (3) any time that volcanic ash is not encountered in an area where it was forecast to be.

(g) References

Further guidance on volcanic ash safety risk assessment is given in ICAO Doc. 9974 (Flight safety and volcanic ash — Risk management of flight operations with known or forecast volcanic ash contamination).

GM3 ORO.GEN.200(a)(3) Management system

SAFETY RISK ASSESSMENT — RISK REGISTER

The results of the assessment of the potential adverse consequences or outcome of each hazard may be recorded by the operator in a risk register, an example of which is provided below.

Hazard		Incident Sequence Description	Existing Controls	Outcome (Pre-Mitigation)			Additional Mitigation required	Outcome (Post-Mitigation)			Actions and Owners	Monitoring and Review Requirements
No.	Description			Severity	Likelihood	Risk		Severity	Likelihood	Risk		

AMC1 ORO.GEN.200(a)(4) Management system

TRAINING AND COMMUNICATION ON SAFETY

- (a) Training
 - (1) All personnel should receive safety training as appropriate for their safety responsibilities.
 - (2) Adequate records of all safety training provided should be kept.
- (b) Communication
 - (1) The operator should establish communication about safety matters that:
 - (i) ensures that all personnel are aware of the safety management activities as appropriate for their safety responsibilities;
 - (ii) conveys safety critical information, especially relating to assessed risks and analysed hazards;
 - (iii) explains why particular actions are taken; and
 - (iv) explains why safety procedures are introduced or changed.
 - (2) Regular meetings with personnel where information, actions and procedures are discussed may be used to communicate safety matters.

GM1 ORO.GEN.200(a)(4) Management system

TRAINING AND COMMUNICATION ON SAFETY

The safety training programme may consist of self-instruction via the media (newsletters, flight safety magazines), classroom training, e-learning or similar training provided by training service providers.

AMC1 ORO.GEN.200(a)(5) Management system

MANAGEMENT SYSTEM DOCUMENTATION — GENERAL

- (a) The operator's management system documentation should at least include the following information:
 - (1) a statement signed by the accountable manager to confirm that the operator will continuously work in accordance with the applicable requirements and the operator's documentation, as required by this Annex;
 - (2) the operator's scope of activities;
 - (3) the titles and names of persons referred to in ORO.GEN.210 (a) and (b);
 - (4) an operator chart showing the lines of responsibility between the persons referred to in ORO.GEN.210;
 - (5) a general description and location of the facilities referred to in ORO.GEN.215;
 - (6) procedures specifying how the operator ensures compliance with the applicable requirements;
 - (7) the amendment procedure for the operator's management system documentation.

- (b) The operator's management system documentation may be included in a separate manual or in (one of) the manual(s), as required by the applicable subpart(s). A cross-reference should be included.

AMC2 ORO.GEN.200(a)(5) Management system

COMPLEX OPERATORS — SAFETY MANAGEMENT MANUAL

- (a) The safety management manual (SMM) should be the key instrument for communicating the approach to safety for the whole of the operator. The SMM should document all aspects of safety management, including the safety policy, objectives, procedures and individual safety responsibilities.
- (b) The contents of the safety management manual should include all of the following:
- (1) scope of the safety management system;
 - (2) safety policy and objectives;
 - (3) safety accountability of the accountable manager;
 - (4) safety responsibilities of key safety personnel;
 - (5) documentation control procedures;
 - (6) hazard identification and risk management schemes;
 - (7) safety action planning;
 - (8) safety performance monitoring;
 - (9) incident investigation and reporting;
 - (10) emergency response planning;
 - (11) management of change (including organisational changes with regard to safety responsibilities);
 - (12) safety promotion.
- (c) The SMM may be contained in (one of) the manual(s) of the operator.

GM1 ORO.GEN.200(a)(5) Management system

MANAGEMENT SYSTEM DOCUMENTATION — GENERAL

- (a) It is not required to duplicate information in several manuals. The information may be contained in any of the operator manuals (e.g. operations manual, training manual), which may also be combined.
- (b) The operator may also choose to document some of the information required to be documented in separate documents (e.g. procedures). In this case, it should ensure that manuals contain adequate references to any document kept separately. Any such documents are then to be considered an integral part of the operator's management system documentation.

AMC1 ORO.GEN.200(a)(6) Management system

COMPLIANCE MONITORING — GENERAL

- (a) Compliance monitoring

The implementation and use of a compliance monitoring function should enable the operator to monitor compliance with the relevant requirements of this Annex and other applicable Annexes.

- (1) The operator should specify the basic structure of the compliance monitoring function applicable to the activities conducted.
 - (2) The compliance monitoring function should be structured according to the size of the operator and the complexity of the activities to be monitored.
- (b) Organisations should monitor compliance with the procedures they have designed to ensure safe activities. In doing so, they should as a minimum, and where appropriate, monitor compliance with:
- (1) privileges of the operator;
 - (2) manuals, logs, and records;
 - (3) training standards;
 - (4) management system procedures and manuals.
- (c) Organisational set up
- (1) To ensure that the operator continues to meet the requirements of this Part and other applicable Parts, the accountable manager should designate a compliance monitoring manager. The role of the compliance monitoring manager is to ensure that the activities of the operator are monitored for compliance with the applicable regulatory requirements, and any additional requirements as established by the operator, and that these activities are carried out properly under the supervision of the relevant head of functional area.
 - (2) The compliance monitoring manager should be responsible for ensuring that the compliance monitoring programme is properly implemented, maintained and continually reviewed and improved.
 - (3) The compliance monitoring manager should:
 - (i) have direct access to the accountable manager;
 - (ii) not be one of the other persons referred to in ORO.GEN.210 (b);
 - (iii) be able to demonstrate relevant knowledge, background and appropriate experience related to the activities of the operator, including knowledge and experience in compliance monitoring; and
 - (iv) have access to all parts of the operator, and as necessary, any contracted operator.
 - (4) In the case of a non-complex operator, this task may be exercised by the accountable manager provided he/she has demonstrated having the related competence as defined in (c)(3)(iii).
 - (5) In the case the same person acts as compliance monitoring manager and as safety manager, the accountable manager, with regards to his/her direct accountability for safety, should ensure that sufficient resources are allocated to both functions, taking into account the size of the operator and the nature and complexity of its activities.
 - (6) The independence of the compliance monitoring function should be established by ensuring that audits and inspections are carried out by personnel not responsible for the function, procedure or products being audited.

- (d) Compliance monitoring documentation
- (1) Relevant documentation should include the relevant part(s) of the operator's management system documentation.
 - (2) In addition, relevant documentation should also include the following:
 - (i) terminology;
 - (ii) specified activity standards;
 - (iii) a description of the operator;
 - (iv) the allocation of duties and responsibilities;
 - (v) procedures to ensure regulatory compliance;
 - (vi) the compliance monitoring programme, reflecting:
 - (A) schedule of the monitoring programme;
 - (B) audit procedures;
 - (C) reporting procedures;
 - (D) follow-up and corrective action procedures; and
 - (E) recording system.
 - (vii) the training syllabus referred to in (e)(2);
 - (viii) document control.
- (e) Training
- (1) Correct and thorough training is essential to optimise compliance in every operator. In order to achieve significant outcome of such training, the operator should ensure that all personnel understand the objectives as laid down in the operator's management system documentation.
 - (2) Those responsible for managing the compliance monitoring function should receive training on this task. Such training should cover the requirements of compliance monitoring, manuals and procedures related to the task, audit techniques, reporting and recording.
 - (3) Time should be provided to train all personnel involved in compliance management and for briefing the remainder of the personnel.
 - (4) The allocation of time and resources should be governed by the volume and complexity of the activities concerned.

GM1 ORO.GEN.200(a)(6) Management system

COMPLIANCE MONITORING — GENERAL

- (a) The organisational set-up of the compliance monitoring function should reflect the size of the operator and the nature and complexity of its activities. The compliance monitoring manager may perform all audits and inspections himself/herself or appoint one or more auditors by choosing personnel having the related competence as defined in AMC1 ORO.GEN.200(a)(6) point (c)(3)(iii), either from, within or outside the operator.

- (b) Regardless of the option chosen it must be ensured that the independence of the audit function is not affected, in particular in cases where those performing the audit or inspection are also responsible for other functions for the operator.
- (c) In case external personnel are used to perform compliance audits or inspections:
 - (1) any such audits or inspections are performed under the responsibility of the compliance monitoring manager; and
 - (2) the operator remains responsible to ensure that the external personnel has relevant knowledge, background and experience as appropriate to the activities being audited or inspected; including knowledge and experience in compliance monitoring.
- (d) The operator retains the ultimate responsibility for the effectiveness of the compliance monitoring function, in particular for the effective implementation and follow-up of all corrective actions.

GM2 ORO.GEN.200(a)(6) Management system

COMPLEX OPERATORS — COMPLIANCE MONITORING PROGRAMME

- (a) Typical subject areas for compliance monitoring audits and inspections for operators should be, as applicable:
 - (1) actual flight operations;
 - (2) ground de-icing/anti-icing;
 - (3) flight support services;
 - (4) load control;
 - (5) technical standards.
- (b) Operators should monitor compliance with the operational procedures they have designed to ensure safe operations, airworthy aircraft and the serviceability of both operational and safety equipment. In doing so, they should, where appropriate, additionally monitor the following:
 - (1) operational procedures;
 - (2) flight safety procedures;
 - (3) operational control and supervision;
 - (4) aircraft performance;
 - (5) all weather operations;
 - (6) communications and navigational equipment and practices;
 - (7) mass, balance and aircraft loading;
 - (8) instruments and safety equipment;
 - (9) ground operations;
 - (10) flight and duty time limitations, rest requirements, and scheduling;
 - (11) aircraft maintenance/operations interface;
 - (12) use of the MEL;
 - (13) flight crew;
 - (14) cabin crew;

- (15) dangerous goods;
- (16) security.

GM3 ORO.GEN.200(a)(6) Management system

NON-COMPLEX OPERATORS — COMPLIANCE MONITORING

- (a) Compliance monitoring audits and inspections may be documented on a 'Compliance Monitoring Checklist', and any findings recorded in a 'Non-compliance Report'. The following documents may be used for this purpose.

COMPLIANCE MONITORING CHECKLIST			
Year:			
Subject	Date checked	Checked by	Comments/Non-compliance Report No.
Flight Operations			
Aircraft checklists checked for accuracy and validity			
Minimum five flight plans checked and verified for proper and correct information			
Flight planning facilities checked for updated manuals, documents and access to relevant flight information			
Incident reports evaluated and reported to the appropriate competent authority			
Ground Handling			
Contracts with ground handling organisations established and valid, if applicable			
Instructions regarding fuelling and de-icing issued, if applicable			
Instructions regarding dangerous goods issued and known by all relevant personnel, if applicable			
Mass & Balance			
Min. five load sheets checked and verified for proper and correct information, if applicable			
Aircraft fleet checked for valid weight check, if applicable			
Minimum one check per aircraft of correct loading and distribution, if applicable			

Training			
Training records updated and accurate			
All pilot licenses checked for currency, correct ratings and valid medical check			
All pilots received recurrent training			
Training facilities & Instructors approved			
All pilots received daily inspection (DI) training			
Documentation			
All issues of operations manual (OM) checked for correct amendment status			
AOC checked for validity and appropriate operations specifications, if applicable			
Aviation requirements applicable and updated			
Crew flight and duty time record updated, if applicable			
Flight documents record checked and updated			
Compliance monitoring records checked and updated			

— NON-COMPLIANCE REPORT — No:			
To Compliance Monitoring Manager	Reported by:	Date:	
Category			
Flight Operations <input type="checkbox"/>	Ground Handling <input type="checkbox"/>	Mass & Balance <input type="checkbox"/>	
Training <input type="checkbox"/>	Documentation <input type="checkbox"/>	Other <input type="checkbox"/>	
Description:		Reference:	
Level of finding:			

Root-cause of non-compliance:	
Suggested correction:	
Compliance Monitoring Manager: <input type="checkbox"/> Corrective action required <input type="checkbox"/> Corrective action not required	
Responsible Person:	Time limitation:
Corrective action:	Reference:
Signature Responsible Person:	Date:
Compliance Monitoring Manager <input type="checkbox"/> Correction and corrective action verified <input type="checkbox"/> Report Closed	
Signature Compliance Monitoring Manager:	Date:

GM4 ORO.GEN.200(a)(6) Management system

AUDIT AND INSPECTION

- (a) 'Audit' means a systematic, independent and documented process for obtaining evidence and evaluating it objectively to determine the extent to which requirements are complied with.
- (b) 'Inspection' means an independent documented conformity evaluation by observation and judgement accompanied as appropriate by measurement, testing or gauging, in order to verify compliance with applicable requirements.

AMC1 ORO.GEN.200(b) Management system

SIZE, NATURE AND COMPLEXITY OF THE ACTIVITY

- (a) An operator should be considered as complex when it has a workforce of more than 20 full time equivalents (FTEs) involved in the activity subject to Regulation (EC) No 216/2008⁶ and its Implementing Rules.

⁶ Regulation (EC) No 216/2008 of the European Parliament and of the Council of 20 February 2008 on common rules in the field of civil aviation and establishing a European Aviation Safety Agency, and repealing Council Directive 91/670/EEC, Regulation (EC) No 1592/2002 and Directive 2004/36/EC. *OJ L 79*, 19.3.2008, p. 1.

-
- (b) Operators with up to 20 FTEs involved in the activity subject to Regulation (EC) No 216/2008⁷ and its Implementing Rules may also be considered complex based on an assessment of the following factors:
- (1) in terms of complexity, the extent and scope of contracted activities subject to the approval;
 - (2) in terms of risk criteria, whether any of the following are present:
 - (i) operations requiring the following specific approvals: performance-based navigation (PBN), low visibility operation (LVO), extended range operations with two-engined aeroplanes (ETOPS), helicopter hoist operation (HHO), helicopter emergency medical service (HEMS), night vision imaging system (NVIS) and dangerous goods (DG);
 - (ii) commercial specialised operations requiring an authorisation;
 - (iii) different types of aircraft used;
 - (iv) the environment (offshore, mountainous area, etc.).

⁷ Regulation (EC) No 216/2008 of the European Parliament and of the Council of 20 February 2008 on common rules in the field of civil aviation and establishing a European Aviation Safety Agency, and repealing Council Directive 91/670/EEC, Regulation (EC) No 1592/2002 and Directive 2004/36/EC. *OJ L 79*, 19.3.2008, p. 1.

ORO.GEN.205 Contracted activities

- (a) The operator shall ensure that when contracting or purchasing any part of its activity, the contracted or purchased service or product conforms to the applicable requirements.
- (b) When the certified operator or the SPO authorisation holder contracts any part of its activity to an organisation that is not itself certified or authorised in accordance with this Part to carry out such activity, the contracted organisation shall work under the approval of the operator. The contracting organisation shall ensure that the competent authority is given access to the contracted organisation, to determine continued compliance with the applicable requirements.

AMC1 ORO.GEN.205 Contracted activities

RESPONSIBILITY WHEN CONTRACTING ACTIVITIES

- (a) The operator may decide to contract certain activities to external organisations.
- (b) A written agreement should exist between the operator and the contracted organisation clearly defining the contracted activities and the applicable requirements.
- (c) The contracted safety-related activities relevant to the agreement should be included in the operator's safety management and compliance monitoring programmes.
- (d) The operator should ensure that the contracted organisation has the necessary authorisation or approval when required, and commands the resources and competence to undertake the task.

GM1 ORO.GEN.205 Contracted activities

CONTRACTING — GENERAL

- (a) Operators may decide to contract certain activities to external organisations for the provision of services related to areas such as:
 - (1) ground de-icing/anti-icing;
 - (2) ground handling;
 - (3) flight support (including performance calculations, flight planning, navigation database and dispatch);
 - (4) training; and
 - (5) manual preparation.
- (b) Contracted activities include all activities within the operator's scope of approval that are performed by another organisation either itself certified or authorised to carry out such activity or if not certified or authorised, working under the operator's approval.
- (c) The ultimate responsibility for the product or service provided by external organisations should always remain with the operator.

GM2 ORO.GEN.205 Contracted activities

RESPONSIBILITY WHEN CONTRACTING ACTIVITIES

- (a) Regardless of the approval status of the contracted organisation, the contracting operator is responsible for ensuring that all contracted activities are subject to hazard identification and risk management, as required by ORO.GEN.200 (a)(3), and to compliance monitoring, as required by ORO.GEN.200 (a)(6).

- (b) When the contracted organisation is itself certified or authorised to carry out the contracted activities, the operator's compliance monitoring should at least check that the approval effectively covers the contracted activities and that it is still valid.

ORO.GEN.210 Personnel requirements

- (a) The operator shall appoint an accountable manager, who has the authority for ensuring that all activities can be financed and carried out in accordance with the applicable requirements. The accountable manager shall be responsible for establishing and maintaining an effective management system.
- (b) A person or group of persons shall be nominated by the operator, with the responsibility of ensuring that the operator remains in compliance with the applicable requirements. Such person(s) shall be ultimately responsible to the accountable manager.
- (c) The operator shall have sufficient qualified personnel for the planned tasks and activities to be performed in accordance with the applicable requirements.
- (d) The operator shall maintain appropriate experience, qualification and training records to show compliance with point (c).
- (e) The operator shall ensure that all personnel are aware of the rules and procedures relevant to the exercise of their duties.

ORO.GEN.215 Facility requirements

The operator shall have facilities allowing the performance and management of all planned tasks and activities in accordance with the applicable requirements.

ORO.GEN.220 Record-keeping

- (a) The operator shall establish a system of record-keeping that allows adequate storage and reliable traceability of all activities developed, covering in particular all the elements indicated in ORO.GEN.200.
- (b) The format of the records shall be specified in the operator's procedures.
- (c) Records shall be stored in a manner that ensures protection from damage, alteration and theft.

AMC1 ORO.GEN.220(b) Record-keeping

GENERAL

- (a) The record-keeping system should ensure that all records are accessible whenever needed within a reasonable time. These records should be organised in a way that ensures traceability and retrievability throughout the required retention period.
- (b) Records should be kept in paper form or in electronic format or a combination of both. Records stored on microfilm or optical disc format are also acceptable. The records should remain legible throughout the required retention period. The retention period starts when the record has been created or last amended.
- (c) Paper systems should use robust material which can withstand normal handling and filing. Computer systems should have at least one backup system which should be updated within 24 hours of any new entry. Computer systems should include safeguards against the ability of unauthorised personnel to alter the data.
- (d) All computer hardware used to ensure data backup should be stored in a different location from that containing the working data and in an environment that ensures they remain in good condition. When hardware or software changes take place, special care should be taken that all necessary data continues to be accessible at least through the full period specified in the

relevant subpart. In the absence of such indication, all records should be kept for a minimum period of 5 years.

GM1 ORO.GEN.220(b) Record-keeping

RECORDS

Microfilming or optical storage of records may be carried out at any time. The records should be as legible as the original record and remain so for the required retention period.

SUBPART AOC: AIR OPERATOR CERTIFICATION

ORO.AOC.100 Application for an air operator certificate

- (a) Without prejudice to Regulation (EC) No 1008/2008 of the European Parliament and the Council⁸, prior to commencing commercial air transport operations, the operator shall apply for and obtain an air operator certificate (AOC) issued by the competent authority.
- (b) The operator shall provide the following information to the competent authority:
- (1) the official name and business name, address, and mailing address of the applicant;
 - (2) a description of the proposed operation, including the type(s), and number of aircraft to be operated;
 - (3) a description of the management system, including organisational structure;
 - (4) the name of the accountable manager;
 - (5) the names of the nominated persons required by ORO.AOC.135(a) together with their qualifications and experience;
 - (6) a copy of the operations manual required by ORO.MLR.100;
 - (7) a statement that all the documentation sent to the competent authority have been verified by the applicant and found in compliance with the applicable requirements.
- (c) Applicants shall demonstrate to the competent authority that:
- (1) they comply with all the requirements of annex IV to Regulation (EC) No 216/2008, this Annex (Part-ORO), Annex IV (Part-CAT) and Annex V (Part-SPA) to this Regulation and Annex I (Part 26) to Regulation (EU) 2015/640⁹;
 - (2) all aircraft operated have a certificate of airworthiness (CofA) in accordance with Regulation (EU) No 748/2012 or are dry-leased in accordance with ORO.AOC.110(d); and
 - (3) its organisation and management are suitable and properly matched to the scale and scope of the operation.

AMC1 ORO.AOC.100 Application for an AOC

APPLICATION TIME FRAMES

The application for the initial issue of an AOC should be submitted at least 90 days before the intended start date of operation. The operations manual may be submitted later, but in any case not later than 60 days before the intended start date of operation.

⁸ OJ L 293, 31.10.2008, p. 3.

⁹ Commission Regulation (EU) 2015/640 of 23 April 2015 on additional airworthiness specifications for a given type of operations and amending Regulation (EU) No 965/2012 (OJ L 106, 24.4.2015, p. 18).

AMC1 ORO.AOC.100(a) Application for an air operator certificate

OPERATOR SECURITY PROGRAMME

In accordance with Regulation (EC) No 300/2008, as part of granting the AOC, the CAT operator should provide the competent authority with the operator's security programme, including security training. The security programme should be adapted to the type and area of operation, as well as to the aircraft operated.

ORO.AOC.105 Operations specifications and privileges of an AOC holder

The privileges of the operator, including those granted in accordance with Annex V (Part-SPA), shall be specified in the operations specifications of the certificate.

ORO.AOC.110 Leasing agreement

Any lease-in

- (a) Without prejudice to Regulation (EC) No 1008/2008, any lease agreement concerning aircraft used by an operator certified in accordance with this Part shall be subject to prior approval by the competent authority.
- (b) The operator certified in accordance with this Part shall not lease-in aircraft included in the list of operators subject to operational restrictions, registered in a State of which all operators under its oversight are subject to an operating ban or from an operator that is subject to an operating ban pursuant to Regulation (EC) No 2111/2005.

Wet lease-in

- (c) The applicant for the approval of the wet lease-in of an aircraft of a third country operator shall demonstrate to the competent authority that:
 - (1) the third country operator holds a valid AOC issued in accordance with ICAO Annex 6;
 - (2) the safety standards of the third country operator with regard to continuing airworthiness and air operations are equivalent to the applicable requirements established by Regulation (EC) No 2042/2003 and this Regulation; and
 - (3) the aircraft has a standard CofA issued in accordance with ICAO Annex 8.

Dry lease-in

- (d) An applicant for the approval of the dry lease-in of an aircraft registered in a third country shall demonstrate to the competent authority that:
 - (1) an operational need has been identified that cannot be satisfied through leasing an aircraft registered in the EU;
 - (2) the duration of the dry lease-in does not exceed seven months in any 12 consecutive month period;
 - (3) compliance with the applicable requirements of Regulation (EU) No 1321/2014 is ensured; and
 - (4) the aircraft is equipped in accordance with the EU regulations for Air Operations.

Dry lease-out

- (e) The operator certified in accordance with this Part intending to dry lease-out one of its aircraft shall apply for prior approval by the competent authority. The application shall be accompanied by copies of the intended lease agreement or description of the lease provisions, except financial arrangements, and all other relevant documentation.

Wet lease-out

- (f) Prior to the wet lease-out of an aircraft, the operator certified in accordance with this Part shall notify the competent authority.

AMC1 ORO.AOC.110 Leasing agreement

GENERAL

The operator intending to lease-in an aircraft should provide the competent authority with the following information:

- (a) the aircraft type, registration markings and serial number;
- (b) the name and address of the registered owner;
- (c) a copy of the valid certificate of airworthiness;
- (d) a copy of the lease agreement or description of the lease provisions, except financial arrangements;
- (e) duration of the lease; and
- (f) in case of wet lease-in, a copy of the AOC of the third country operator and the areas of operation.

The information mentioned above should be accompanied by a statement signed by the lessee that the parties to the lease agreement fully understand their respective responsibilities under the applicable regulations.

AMC1 ORO.AOC.110(c) Leasing agreement

WET LEASE-IN

If the operator is not intending to apply EU safety requirements for air operations and continuing airworthiness when wet leasing-in an aircraft registered in a third country, it should demonstrate to the competent authority that the standards complied with are equivalent to the following requirements:

- (a) Annex IV (Part-CAT);
- (b) Part-ORO:
 - (1) ORO.GEN.110 and Section 2 of Subpart GEN;
 - (2) ORO.MLR, excluding ORO.MLR.105;
 - (3) ORO.FC;
 - (4) ORO.CC, excluding ORO.CC.200 and ORO.CC.210(a);
 - (5) ORO.TC;
 - (6) ORO.FTL, including related CS-FTL; and
 - (7) ORO.SEC;
- (c) Annex V (Part-SPA), if applicable;
- (d) for continuing airworthiness management of the third country operator, Part-M¹⁰ Subpart-B, Subpart-C and Subpart-G, excluding M.A.707, and M.A.710;

¹⁰ Commission Regulation (EC) No 2042/2003 of 20 November 2003 on the continuing airworthiness of aircraft and aeronautical products, parts and appliances, and on the approval of organisations and personnel involved in these tasks (OJ L 315, 28.11.2003, p. 1). Regulation as last amended by Commission Regulation (EU) No 1149/2011 of 21 October 2011 (OJ L 298, 16.11.2011, p. 1).

- (e) for the maintenance organisation used by the third country operator during the lease period: Part-145¹¹; and
- (f) the operator should provide the competent authority with a full description of the flight time limitation scheme(s), operating procedures and safety assessment demonstrating compliance with the safety objectives set out in points (b) (1)-(6).

AMC2 ORO.AOC.110(c) Leasing agreement

WET LEASE-IN

The lessee should maintain a record of occasions when lessors are used, for inspection by the State that issued its AOC.

GM1 ORO.AOC.110(c) Leasing agreement

SHORT-TERM WET LEASE-IN

In anticipation of an operational need the operator may enter into a framework agreement with more than one third country operator provided that these operators comply with ORO.AOC.110 (c). These third country operators should be placed in a list maintained by the lessee.

AMC1 ORO.AOC.110(f) Leasing agreement

WET LEASE-OUT

When notifying the competent authority, the operator intending to wet lease-out an aircraft should provide the competent authority with the following information:

- (a) the aircraft type, registration markings and serial number;
- (b) the name and address of the lessee;
- (c) a copy of the lease agreement or description of the lease provisions, except financial arrangements; and
- (d) the duration of the lease agreement.

¹¹ Commission Regulation (EC) No 2042/2003 of 20 November 2003 on the continuing airworthiness of aircraft and aeronautical products, parts and appliances, and on the approval of organisations and personnel involved in these tasks (OJ L 315, 28.11.2003, p. 1). Regulation as last amended by Commission Regulation (EU) No 1149/2011 of 21 October 2011 (OJ L 298, 16.11.2011, p. 1).

ORO.AOC.115 Code-share agreements

- (a) Without prejudice to applicable EU safety requirements for third country operators and aircraft, an operator certified in accordance with this Part shall enter into a code-share agreement with a third country operator only after:
 - (1) having verified that the third country operator complies with the applicable ICAO standards; and
 - (2) having provided the competent authority with documented information enabling such authority to comply with ARO.OPS.105.
- (b) When implementing the code-share agreement the operator shall monitor and regularly assess the ongoing compliance of the third country operator with the applicable ICAO standards.
- (c) The operator certified in accordance with this Part shall not sell and issue tickets for a flight operated by a third country operator when the third country operator is subject to an operating ban pursuant to Regulation (EC) No 2111/2005 or is failing to maintain compliance with the applicable ICAO standards.

AMC1 ORO.AOC.115(a)(1) Code share agreements

INITIAL VERIFICATION OF COMPLIANCE

- (a) In order to verify the third country operator's compliance with the applicable ICAO standards, in particular ICAO Annexes 1, 2, 6, Part I and III, as applicable, 8 and 18, the EU operator should conduct an audit of the third country operator, including interviews of personnel and inspections carried out at the third country operator's facilities.
- (b) The audit should focus on the operational, management and control systems of the operator.

AMC1 ORO.AOC.115(b) Code-share arrangements

CODE-SHARE AUDIT PROGRAMME

- (a) Operators should establish a code-share audit programme for monitoring continuous compliance of the third country operator with the applicable ICAO standards. Such a code-share audit programme should include:
 - (1) the audit methodology (audit report + compliance statements);
 - (2) details of the specific operational areas to audit;
 - (3) criteria for defining satisfactory audit results;
 - (4) a system for reporting and correcting findings;
 - (5) a continuous monitoring system;
 - (6) auditor qualification and authorisation; and
 - (7) the frequency of audits.
- (b) The third country code-share operator should be audited at periods not exceeding 24 months. The beginning of the first 24-month oversight planning cycle is determined by the date of the first audit and should then determine the start and end dates of the recurrent 24-month planning cycle. The interval between two audits should not exceed 24 months.
- (c) The EU operator should ensure a renewal audit of each third country code-share operator prior to the audit expiry date of the previous audit. The audit expiry date for the previous audit

becomes the audit effective date for the renewal audit provided the closing meeting for the renewal audit is within 150 days prior to the audit expiry date for the previous audit. If the closing meeting for the renewal audit is more than 150 days prior to the audit expiry date from the previous audit, then the audit effective date for the renewal audit is the day of the closing meeting of the renewal audit. Renewal audits are valid for 24 consecutive months beginning with the audit effective date and ending with the audit expiry date.

- (d) A code-share audit could be shared by several operators. In case of a shared audit, the report should be made available for review by all duly identified sharing operators by any means.
- (e) After closure of all findings identified during the audit, the EU operator should submit an audit compliance statement to the competent authority demonstrating that the third country operator meets all the applicable safety standards.

AMC2 ORO.AOC.115(b) Code-share agreements

THIRD PARTY PROVIDERS

- (a) The initial audit and/or the continuous monitoring may be performed by a third party provider on behalf of the EU operator when it is demonstrated that:
 - (1) a documented arrangement has been established with the third party provider;
 - (2) the audit standards applied by the third party provider addresses the scope of the regulation in sufficient detail;
 - (3) the third party provider uses an evaluation system, designed to assess the operational, management and control systems of the third country code-share operator;
 - (4) independence of the third party provider, its evaluation system as well as the impartiality of the auditors is ensured;
 - (5) the auditors are appropriately qualified and have sufficient knowledge, experience and training, including on-the-job training, to perform their allocated tasks;
 - (6) audits are performed on-site;
 - (7) access to the relevant data and facilities is granted to the level of detail necessary to verify compliance with the applicable requirements;
 - (8) access to the full audit report is granted to the EU operator;
 - (9) procedures have been established for monitoring continued compliance of the third country code-share operator with the applicable requirements, taking into account the timelines in AMC1 ORO.AOC.115(b)(b) and (c);
 - (10) procedures have been established to notify the third country code-share operator of any non-compliance with the applicable requirements, the corrective actions to be taken, the follow up of these corrective actions and closure of findings.
- (b) The use of a third party provider for the initial audit or the monitoring of continuous compliance of the third country code-share operator does not exempt the EU operator from its responsibility under ORO.AOC.115.
- (c) The EU operator should maintain a list of the third country code-share operators monitored by the third party provider. This list and the full audit report prepared by the third party provider should be made available to the competent authority upon request.

ORO.AOC.120 Approvals to provide cabin crew training and to issue cabin crew attestations

- (a) When intending to provide the training course required in Annex V (Part-CC) to Regulation (EU) No 1178/2011, the operator shall apply for and obtain an approval issued by the competent authority. For this purpose, the applicant shall demonstrate compliance with the requirements for the conduct and content of training course established in CC.TRA.215 and CC.TRA.220 of that Annex and shall provide the competent authority with:
- (1) the date of intended commencement of activity;
 - (2) the personal details and qualifications of the instructors as relevant to the training elements to be covered;
 - (3) the name(s) and address(es) of the training site(s) at which the training is to be conducted;
 - (4) a description of the facilities, training methods, manuals and representative devices to be used; and
 - (5) the syllabi and associated programmes for the training course.
- (b) If a Member State decides, in accordance with ARA.CC.200 of Annex VI (Part-ARA) to Regulation (EU) No 1178/2011, that operators may be approved to issue cabin crew attestations, the applicant shall, in addition to (a):
- (1) demonstrate to the competent authority that:
 - (i) the organisation has the capability and accountability to perform this task;
 - (ii) the personnel conducting examinations are appropriately qualified and free from conflict of interest; and
 - (2) provide the procedures and the specified conditions for:
 - (i) conducting the examination required by CC.TRA.220;
 - (ii) issuing cabin crew attestations; and
 - (iii) supplying the competent authority with all relevant information and documentation related to the attestations it will issue and their holders, for the purpose of record-keeping, oversight and enforcement actions by that authority.
- (c) The approvals referred to in (a) and (b) shall be specified in the operations specifications.

ORO.AOC.125 Non-commercial operations of aircraft listed in the operations specifications by the holder of an AOC

- (a) The holder of an AOC may conduct non-commercial operations with an aircraft otherwise used for commercial air transport operations that is listed in the operations specifications of its AOC, provided that the operator:
- (1) describes such operations in detail in the operations manual, including:
 - (i) identification of the applicable requirements;
 - (ii) a clear identification of any differences between operating procedures used when conducting commercial air transport and non-commercial operations;
 - (iii) a means of ensuring that all personnel involved in the operation are fully familiar with the associated procedures;
 - (2) submits the identified differences between the operating procedures referred to in (a)(1)(ii) to the competent authority for prior approval.

- (b) An AOC holder conducting operations referred to in (a) shall not be required to submit a declaration in accordance with this Part.

ORO.AOC.130 Flight data monitoring — aeroplanes

- (a) The operator shall establish and maintain a flight data monitoring programme, which shall be integrated in its management system, for aeroplanes with a maximum certificated take-off mass of more than 27 000 kg.
- (b) The flight data monitoring programme shall be non-punitive and contain adequate safeguards to protect the source(s) of the data.

AMC1 ORO.AOC.130 Flight data monitoring — aeroplanes

FLIGHT DATA MONITORING (FDM) PROGRAMME

- (a) The safety manager, as defined under AMC1-ORO.GEN.200(a)(1), should be responsible for the identification and assessment of issues and their transmission to the manager(s) responsible for the process(es) concerned. The latter should be responsible for taking appropriate and practicable safety action within a reasonable period of time that reflects the severity of the issue.
- (b) An FDM programme should allow an operator to:
- (1) identify areas of operational risk and quantify current safety margins;
 - (2) identify and quantify operational risks by highlighting occurrences of non-standard, unusual or unsafe circumstances;
 - (3) use the FDM information on the frequency of such occurrences, combined with an estimation of the level of severity, to assess the safety risks and to determine which may become unacceptable if the discovered trend continues;
 - (4) put in place appropriate procedures for remedial action once an unacceptable risk, either actually present or predicted by trending, has been identified; and
 - (5) confirm the effectiveness of any remedial action by continued monitoring.
- (c) FDM analysis techniques should comprise the following:
- (1) Exceedance detection: searching for deviations from aircraft flight manual limits and standard operating procedures. A set of core events should be selected to cover the main areas of interest to the operator. A sample list is provided in Appendix 1 to AMC1 ORO.AOC.130. The event detection limits should be continuously reviewed to reflect the operator's current operating procedures.
 - (2) All flights measurement: a system defining what is normal practice. This may be accomplished by retaining various snapshots of information from each flight.
 - (3) Statistics — a series of data collected to support the analysis process: this technique should include the number of flights flown per aircraft and sector details sufficient to generate rate and trend information.
- (d) FDM analysis, assessment and process control tools: the effective assessment of information obtained from digital flight data should be dependent on the provision of appropriate information technology tool sets.
- (e) Education and publication: sharing safety information should be a fundamental principle of aviation safety in helping to reduce accident rates. The operator should pass on the lessons learnt to all relevant personnel and, where appropriate, industry.

-
- (f) Accident and incident data requirements specified in CAT.GEN.MPA.195 take precedence over the requirements of an FDM programme. In these cases the FDR data should be retained as part of the investigation data and may fall outside the de-identification agreements.
- (g) Every crew member should be responsible for reporting events. Significant risk-bearing incidents detected by FDM should therefore normally be the subject of mandatory occurrence reporting by the crew. If this is not the case, then they should submit a retrospective report that should be included under the normal process for reporting and analysing hazards, incidents and accidents.
- (h) The data recovery strategy should ensure a sufficiently representative capture of flight information to maintain an overview of operations. Data analysis should be performed sufficiently frequently to enable action to be taken on significant safety issues.
- (i) The data retention strategy should aim at providing the greatest safety benefits practicable from the available data. A full dataset should be retained until the action and review processes are complete; thereafter, a reduced dataset relating to closed issues should be maintained for longer-term trend analysis. Programme managers may wish to retain samples of de-identified full-flight data for various safety purposes (detailed analysis, training, benchmarking, etc.).
- (j) The data access and security policy should restrict information access to authorised persons. When data access is required for airworthiness and maintenance purposes, a procedure should be in place to prevent disclosure of crew identity.
- (k) The procedure to prevent disclosure of crew identity should be written in a document, which should be signed by all parties (airline management, flight crew member representatives nominated either by the union or the flight crew themselves). This procedure should, as a minimum, define:
- (1) the aim of the FDM programme;
 - (2) a data access and security policy that should restrict access to information to specifically authorised persons identified by their position;
 - (3) the method to obtain de-identified crew feedback on those occasions that require specific flight follow-up for contextual information; where such crew contact is required the authorised person(s) need not necessarily be the programme manager or safety manager, but could be a third party (broker) mutually acceptable to unions or staff and management;
 - (4) the data retention policy and accountability, including the measures taken to ensure the security of the data;
 - (5) the conditions under which advisory briefing or remedial training should take place; this should always be carried out in a constructive and non-punitive manner;
 - (6) the conditions under which the confidentiality may be withdrawn for reasons of gross negligence or significant continuing safety concern;
 - (7) the participation of flight crew member representative(s) in the assessment of the data, the action and review process and the consideration of recommendations; and
 - (8) the policy for publishing the findings resulting from FDM.
- (l) Airborne systems and equipment used to obtain FDM data should range from an already installed full quick access recorder (QAR), in a modern aircraft with digital systems, to a basic crash-protected recorder in an older or less sophisticated aircraft. The analysis potential of the reduced data set available in the latter case may reduce the safety benefits obtainable. The

operator should ensure that FDM use does not adversely affect the serviceability of equipment required for accident investigation.

GM1 ORO.AOC.130 Flight data monitoring — aeroplanes

DEFINITION OF AN FDM PROGRAMME

For the purposes of this Guidance Material, an FDM programme may be defined as a proactive and non-punitive programme for gathering and analysing data recorded during routine flights to improve aviation safety.

(a) FDM analysis techniques

(1) Exceedance detection

- (i) FDM programmes are used for detecting exceedances, such as deviations from flight manual limits, standard operating procedures (SOPs), or good airmanship. Typically, a set of core events establishes the main areas of interest to operators.

Examples: high lift-off rotation rate, stall warning, ground proximity warning system (GPWS) warning, flap limit speed exceedance, fast approach, high/low on glideslope, and heavy landing.

- (ii) Trigger logic expressions may be simple exceedances such as redline values. The majority, however, are composites that define a certain flight mode, aircraft configuration or payload-related condition. Analysis software can also assign different sets of rules dependent on airport or geography. For example, noise sensitive airports may use higher than normal glideslopes on approach paths over populated areas. In addition, it might be valuable to define several levels of exceedance severity (such as low, medium and high).

- (iii) Exceedance detection provides useful information, which can complement that provided in crew reports.

Examples: reduced flap landing, emergency descent, engine failure, rejected take-off, go-around, airborne collision avoidance system (ACAS) or GPWS warning, and system malfunctions.

- (iv) The operator may also modify the standard set of core events to account for unique situations they regularly experience, or the SOPs they use.

Example: to avoid nuisance exceedance reports from a non-standard instrument departure.

- (v) The operator may also define new events to address specific problem areas.

Example: restrictions on the use of certain flap settings to increase component life.

(2) All-flights measurements

FDM data are retained from all flights, not just the ones producing significant events. A selection of parameters is retained that is sufficient to characterise each flight and allow a comparative analysis of a wide range of operational variability. Emerging trends and tendencies may be identified and monitored before the trigger levels associated with exceedances are reached.

Examples of parameters monitored: take-off weight, flap setting, temperature, rotation and lift-off speeds versus scheduled speeds, maximum pitch rate and attitude during rotation, and gear retraction speeds, heights and times.

Examples of comparative analyses: pitch rates from high versus low take-off weights, good versus bad weather approaches, and touchdowns on short versus long runways.

(3) Statistics

Series of data are collected to support the analysis process: these usually include the numbers of flights flown per aircraft and sector details sufficient to generate rate and trend information.

(4) Investigation of incidents flight data

Recorded flight data provide valuable information for follow-up to incidents and other technical reports. They are useful in adding to the impressions and information recalled by the flight crew. They also provide an accurate indication of system status and performance, which may help in determining cause and effect relationships.

Examples of incidents where recorded data could be useful:

- high cockpit workload conditions as corroborated by such indicators as late descent, late localizer and/or glideslope interception, late landing configuration;
- unstabilised and rushed approaches, glide path excursions, etc.;
- exceedances of prescribed operating limitations (such as flap limit speeds, engine overtemperatures); and
- wake vortex encounters, turbulence encounters or other vertical accelerations.

It should be noted that recorded flight data have limitations, e.g. not all the information displayed to the flight crew is recorded, the source of recorded data may be different from the source used by a flight instrument, the sampling rate or the recording resolution of a parameter may be insufficient to capture accurate information.

(5) Continuing airworthiness

Data of all-flight measurements and exceedance detections can be utilised to assist the continuing airworthiness function. For example, engine-monitoring programmes look at measures of engine performance to determine operating efficiency and predict impending failures.

Examples of continuing airworthiness uses: engine thrust level and airframe drag measurements, avionics and other system performance monitoring, flying control performance, and brake and landing gear usage.

(b) FDM equipment

(1) General

FDM programmes generally involve systems that capture flight data, transform the data into an appropriate format for analysis, and generate reports and visualisation to assist in assessing the data. Typically, the following equipment capabilities are needed for effective FDM programmes:

- (i) an on-board device to capture and record data on a wide range of in-flight parameters;
- (ii) a means to transfer the data recorded on board the aircraft to a ground-based processing station;

- (iii) a ground-based computer system to analyse the data, identify deviations from expected performance, generate reports to assist in interpreting the read-outs, etc.; and
 - (iv) optional software for a flight animation capability to integrate all data, presenting them as a simulation of in-flight conditions, thereby facilitating visualisation of actual events.
 - (2) Airborne equipment
 - (i) The flight parameters and recording capacity required for flight data recorders (FDR) to support accident investigations may be insufficient to support an effective FDM programme. Other technical solutions are available, including the following:
 - (A) Quick access recorders (QARs). QARs are installed in the aircraft and record flight data onto a low-cost removable medium.
 - (B) Some systems automatically download the recorded information via secure wireless systems when the aircraft is in the vicinity of the gate. There are also systems that enable the recorded data to be analysed on board while the aircraft is airborne.
 - (ii) Fleet composition, route structure and cost considerations will determine the most cost-effective method of removing the data from the aircraft.
 - (3) Ground replay and analysis equipment
 - (i) Data are downloaded from the aircraft recording device into a ground-based processing station, where the data are held securely to protect this sensitive information.
 - (ii) FDM programmes generate large amounts of data requiring specialised analysis software.
 - (iii) The analysis software checks the downloaded flight data for abnormalities.
 - (iv) The analysis software may include: annotated data trace displays, engineering unit listings, visualisation for the most significant incidents, access to interpretative material, links to other safety information and statistical presentations.
- (c) FDM in practice
 - (1) FDM process

Typically, operators follow a closed-loop process in applying an FDM programme, for example:

 - (i) Establish a baseline: initially, operators establish a baseline of operational parameters against which changes can be detected and measured.

Examples: rate of unstable approaches or hard landings.
 - (ii) Highlight unusual or unsafe circumstances: the user determines when non-standard, unusual or basically unsafe circumstances occur; by comparing them to the baseline margins of safety, the changes can be quantified.

Example: increases in unstable approaches (or other unsafe events) at particular locations.

- (iii) Identify unsafe trends: based on the frequency and severity of occurrence, trends are identified. Combined with an estimation of the level of severity, the risks are assessed to determine which may become unacceptable if the trend continues.
Example: a new procedure has resulted in high rates of descent that are nearly triggering GPWS warnings.
 - (iv) Mitigate risks: once an unacceptable risk has been identified, appropriate risk mitigation actions are decided on and implemented.
Example: having found high rates of descent, the SOPs are changed to improve aircraft control for optimum/maximum rates of descent.
 - (v) Monitor effectiveness: once a remedial action has been put in place, its effectiveness is monitored, confirming that it has reduced the identified risk and that the risk has not been transferred elsewhere.
Example: confirm that other safety measures at the aerodrome with high rates of descent do not change for the worse after changes in approach procedures.
- (2) Analysis and follow-up
- (i) FDM data are typically compiled every month or at shorter intervals. The data are then reviewed to identify specific exceedances and emerging undesirable trends and to disseminate the information to flight crews.
 - (ii) If deficiencies in pilot handling technique are evident, the information is usually de-identified in order to protect the identity of the flight crew. The information on specific exceedances is passed to a person (safety manager, agreed flight crew representative, honest broker) assigned by the operator for confidential discussion with the pilot. The person assigned by the operator provides the necessary contact with the pilot in order to clarify the circumstances, obtain feedback and give advice and recommendations for appropriate action. Such appropriate action could include re-training for the pilot (carried out in a constructive and non-punitive way), revisions to manuals, changes to ATC and airport operating procedures.
 - (iii) Follow-up monitoring enables the effectiveness of any corrective actions to be assessed. Flight crew feedback is essential for the identification and resolution of safety problems and could be collected through interviews, for example by asking the following:
 - (A) Are the desired results being achieved soon enough?
 - (B) Have the problems really been corrected, or just relocated to another part of the system?
 - (C) Have new problems been introduced?
 - (iv) All events are usually archived in a database. The database is used to sort, validate and display the data in easy-to-understand management reports. Over time, this archived data can provide a picture of emerging trends and hazards that would otherwise go unnoticed.
 - (v) Lessons learnt from the FDM programme may warrant inclusion in the operator's safety promotion programmes. Safety promotion media may include newsletters, flight safety magazines, highlighting examples in training and simulator exercises, periodic reports to industry and the competent authority. Care is required, however, to ensure that any information acquired through FDM is de-identified before using it in any training or promotional initiative.

- (vi) All successes and failures are recorded, comparing planned programme objectives with expected results. This provides a basis for review of the FDM programme and the foundation for future programme development.

(d) Preconditions for an effective FDM programme

(1) Protection of FDM data

The integrity of FDM programmes rests upon protection of the FDM data. Any disclosure for purposes other than safety management can compromise the voluntary provision of safety data, thereby compromising flight safety.

(2) Essential trust

The trust established between management and flight crew is the foundation for a successful FDM programme. This trust can be facilitated by:

- (i) early participation of the flight crew representatives in the design, implementation and operation of the FDM programme;
- (ii) a formal agreement between management and flight crew, identifying the procedures for the use and protection of data; and
- (iii) data security, optimised by:
 - (A) adhering to the agreement;
 - (B) the operator strictly limiting data access to selected individuals;
 - (C) maintaining tight control to ensure that identifying data is kept securely; and
 - (D) ensuring that operational problems are promptly addressed by management.

(3) Requisite safety culture

Indicators of an effective safety culture typically include:

- (i) top management's demonstrated commitment to promoting a proactive safety culture;
- (ii) a non-punitive operator policy that covers the FDM programme;
- (iii) FDM programme management by dedicated staff under the authority of the safety manager, with a high degree of specialisation and logistical support;
- (iv) involvement of persons with appropriate expertise when identifying and assessing the risks (for example, pilots experienced on the aircraft type being analysed);
- (v) monitoring fleet trends aggregated from numerous operations, not focusing only on specific events;
- (vi) a well-structured system to protect the confidentiality of the data; and
- (vii) an efficient communication system for disseminating hazard information (and subsequent risk assessments) internally and to other organisations to permit timely safety action.

(e) Implementing an FDM programme

(1) General considerations

- (i) Typically, the following steps are necessary to implement an FDM programme:

-
- (A) implementation of a formal agreement between management and flight crew;
 - (B) establishment and verification of operational and security procedures;
 - (C) installation of equipment;
 - (D) selection and training of dedicated and experienced staff to operate the programme; and
 - (E) commencement of data analysis and validation.
- (ii) An operator with no FDM experience may need a year to achieve an operational FDM programme. Another year may be necessary before any safety and cost benefits appear. Improvements in the analysis software, or the use of outside specialist service providers, may shorten these time frames.
- (2) Aims and objectives of an FDM programme
- (i) As with any project there is a need to define the direction and objectives of the work. A phased approach is recommended so that the foundations are in place for possible subsequent expansion into other areas. Using a building block approach will allow expansion, diversification and evolution through experience.
- Example: with a modular system, begin by looking at basic safety-related issues only. Add engine health monitoring, etc. in the second phase. Ensure compatibility with other systems.
- (ii) A staged set of objectives starting from the first week's replay and moving through early production reports into regular routine analysis will contribute to a sense of achievement as milestones are met.
- Examples of short-term, medium-term and long-term goals:
- (A) Short-term goals:
 - establish data download procedures, test replay software and identify aircraft defects;
 - validate and investigate exceedance data; and
 - establish a user-acceptable routine report format to highlight individual exceedances and facilitate the acquisition of relevant statistics.
 - (B) Medium-term goals:
 - produce an annual report — include key performance indicators;
 - add other modules to the analysis (e.g. continuing airworthiness); and
 - plan for the next fleet to be added to programme.
 - (C) Long-term goals:
 - network FDM information across all of the operator's safety information systems;
 - ensure FDM provision for any proposed alternative training and qualification programme (ATQP); and
 - use utilisation and condition monitoring to reduce spares holdings.

- (iii) Initially, focusing on a few known areas of interest will help prove the system's effectiveness. In contrast to an undisciplined 'scatter-gun' approach, a focused approach is more likely to gain early success.

Examples: rushed approaches, or rough runways at particular aerodromes. Analysis of such known problem areas may generate useful information for the analysis of other areas.

(3) The FDM team

- (i) Experience has shown that the 'team' necessary to run an FDM programme could vary in size from one person for a small fleet, to a dedicated section for large fleets. The descriptions below identify various functions to be fulfilled, not all of which need a dedicated position.
 - (A) Team leader: it is essential that the team leader earns the trust and full support of both management and flight crew. The team leader acts independently of others in line management to make recommendations that will be seen by all to have a high level of integrity and impartiality. The individual requires good analytical, presentation and management skills.
 - (B) Flight operations interpreter: this person is usually a current pilot (or perhaps a recently retired senior captain or instructor), who knows the operator's route network and aircraft. This team member's in-depth knowledge of SOPs, aircraft handling characteristics, aerodromes and routes is used to place the FDM data in a credible context.
 - (C) Technical interpreter: this person interprets FDM data with respect to the technical aspects of the aircraft operation and is familiar with the power plant, structures and systems departments' requirements for information and any other engineering monitoring programmes in use by the operator.
 - (D) Gate-keeper: this person provides the link between the fleet or training managers and flight crew involved in events highlighted by FDM. The position requires good people skills and a positive attitude towards safety education. The person is typically a representative of the flight crew association or an 'honest broker' and is the only person permitted to connect the identifying data with the event. It is essential that this person earns the trust of both management and flight crew.
 - (E) Engineering technical support: this person is usually an avionics specialist, involved in the supervision of mandatory serviceability requirements for FDR systems. This team member is knowledgeable about FDM and the associated systems needed to run the programme.
 - (F) Replay operative and administrator: this person is responsible for the day-to-day running of the system, producing reports and analysis.
- (ii) All FDM team members need appropriate training or experience for their respective area of data analysis. Each team member is allocated a realistic amount of time to regularly spend on FDM tasks.

Appendix 1 to AMC1 ORO.AOC.130 Flight data monitoring — aeroplanes

TABLE OF FDM EVENTS

The following table provides examples of FDM events that may be further developed using operator and aeroplane specific limits. The table is considered illustrative and not exhaustive.

Event Group	Description
Rejected take-off	High speed rejected take-off
Take-off pitch	Pitch rate high on take-off
	Pitch attitude high during take-off
Unstick speeds	Unstick speed high
	Unstick speed low
Height loss in climb-out	Initial climb height loss 20 ft above ground level (AGL) to 400 ft above aerodrome level (AAL)
	Initial climb height loss 400 ft to 1 500 ft AAL
Slow climb-out	Excessive time to 1 000 ft AAL after take-off
Climb-out speeds	Climb-out speed high below 400 ft AAL
	Climb-out speed high 400 ft AAL to 1 000 ft AAL
	Climb-out speed low 35 ft AGL to 400 ft AAL
	Climb-out speed low 400 ft AAL to 1 500 ft AAL
High rate of descent	High rate of descent below 2 000 ft AGL
Missed approach	Missed approach below 1 000 ft AAL
	Missed approach above 1 000 ft AAL
Low approach	Low on approach
Glideslope	Deviation under glideslope
	Deviation above glideslope (below 600 ft AGL)
Approach power	Low power on approach
Approach speeds	Approach speed high within 90 seconds of touchdown
	Approach speed high below 500 ft AAL
	Approach speed high below 50 ft AGL

Event Group	Description
	Approach speed low within 2 minutes of touchdown
Landing flap	Late land flap (not in position below 500 ft AAL)
	Reduced flap landing
	Flap load relief system operation
Landing pitch	Pitch attitude high on landing
	Pitch attitude low on landing
Bank angles	Excessive bank below 100 ft AGL
	Excessive bank 100 ft AGL to 500 ft AAL
	Excessive bank above 500 ft AGL
	Excessive bank near ground (below 20 ft AGL)
Normal acceleration	High normal acceleration on ground
	High normal acceleration in flight flaps up (+/- increment)
	High normal acceleration in flight flaps down(+/- increment)
	High normal acceleration at landing
Abnormal configuration	Take-off configuration warning
	Early configuration change after take-off (flap)
	Speed brake with flap
	Speed brake on approach below 800 ft AAL
	Speed brake not armed below 800 ft AAL
Ground proximity warning	Ground proximity warning system (GPWS) operation - hard warning
	GPWS operation — soft warning
	GPWS operation — windshear warning
	GPWS operation — false warning
Airborne collision avoidance system (ACAS II) warning	ACAS operation — Resolution Advisory
Margin to stall/buffet	Stick shake

Event Group	Description
	False stick shake
	Reduced lift margin except near ground
	Reduced lift margin at take-off
	Low buffet margin (above 20 000 ft)
Aircraft flight manual limitations	Maximum operating speed limit (V_{MO}) exceedance
	Maximum operating speed limit (M_{MO}) exceedance
	Flap placard speed exceedance
	Gear down speed exceedance
	Gear selection up/down speed exceedance
	Flap/slat altitude exceedance
	Maximum operating altitude exceedance

GM2 ORO.AOC.130 Flight data monitoring — aeroplanes

FLIGHT DATA MONITORING

Additional guidance material for the establishment of flight data monitoring can be found in UK Civil Aviation Authority CAP 739 (Flight Data Monitoring).

ORO.AOC.135 Personnel requirements

- (a) In accordance with ORO.GEN.210(b), the operator shall nominate persons responsible for the management and supervision of the following areas:
- (1) flight operations;
 - (2) crew training;
 - (3) ground operations; and
 - (4) continuing airworthiness in accordance with Regulation (EC) No 2042/2003.
- (b) *Adequacy and competency of personnel*
- (1) The operator shall employ sufficient personnel for the planned ground and flight operations.
 - (2) All personnel assigned to, or directly involved in, ground and flight operations shall:
 - (i) be properly trained;
 - (ii) demonstrate their capabilities in the performance of their assigned duties; and
 - (iii) be aware of their responsibilities and the relationship of their duties to the operation as a whole.
- (c) *Supervision of personnel*
- (1) The operator shall appoint a sufficient number of personnel supervisors, taking into account the structure of the operator's organisation and the number of personnel employed.
 - (2) The duties and responsibilities of these supervisors shall be defined, and any other necessary arrangements shall be made to ensure that they can discharge their supervisory responsibilities.
 - (3) The supervision of crew members and personnel involved in the operation shall be exercised by individuals with adequate experience and the skills to ensure the attainment of the standards specified in the operations manual.

AMC1 ORO.AOC.135(a) Personnel requirements**NOMINATED PERSONS**

- (a) The person may hold more than one of the nominated posts if such an arrangement is considered suitable and properly matched to the scale and scope of the operation.
- (b) A description of the functions and the responsibilities of the nominated persons, including their names, should be contained in the operations manual.
- (c) The holder of an AOC should make arrangements to ensure continuity of supervision in the absence of nominated persons.
- (d) The person nominated by the holder of an AOC should not be nominated by another holder of an AOC, unless agreed with the competent authorities concerned.
- (e) Persons nominated should be contracted to work sufficient hours to fulfil the management functions associated with the scale and scope of the operation.

AMC2 ORO.AOC.135(a) Personnel requirements

COMBINATION OF NOMINATED PERSONS RESPONSIBILITIES

- (a) The acceptability of a single person holding several posts, possibly in combination with being the accountable manager, should depend upon the nature and scale of the operation. The two main areas of concern should be competence and an individual's capacity to meet his/her responsibilities.
- (b) As regards competence in different areas of responsibility, there should not be any difference from the requirements applicable to persons holding only one post.
- (c) The capacity of an individual to meet his/her responsibilities should primarily be dependent upon the scale of the operation. However, the complexity of the organisation or of the operation may prevent, or limit, combinations of posts which may be acceptable in other circumstances.
- (d) In most circumstances, the responsibilities of a nominated person should rest with a single individual. However, in the area of ground operations, it may be acceptable for responsibilities to be split, provided that the responsibilities of each individual concerned are clearly defined.

GM1 ORO.AOC.135(a) Personnel requirements

NOMINATED PERSONS

The smallest organisation that can be considered is the one-man organisation where all of the nominated posts are filled by the accountable manager, and audits are conducted by an independent person.

GM2 ORO.AOC.135(a) Personnel requirements

COMPETENCE OF NOMINATED PERSONS

- (a) Nominated persons in accordance with ORO.AOC.135 should be expected to possess the experience and meet the licensing provisions that are listed in (b) to (f). Exceptionally, in particular cases, the competent authority may accept a nomination that does not meet these provisions in full. In that circumstance, the nominee should have comparable experience and also the ability to perform effectively the functions associated with the post and with the scale of the operation.
- (b) Nominated persons should have:
 - (1) practical experience and expertise in the application of aviation safety standards and safe operating practices;
 - (2) comprehensive knowledge of:
 - (i) the applicable EU safety regulations and any associated requirements and procedures;
 - (ii) the AOC holder's operations specifications; and
 - (iii) the need for, and content of, the relevant parts of the AOC holder's operations manual;
 - (3) familiarity with management systems preferably in the area of aviation;
 - (4) appropriate management experience, preferably in a comparable organisation; and

-
- (5) 5 years of relevant work experience of which at least 2 years should be from the aeronautical industry in an appropriate position.
- (c) Flight operations. The nominated person should hold or have held a valid flight crew licence and the associated ratings appropriate to a type of operation conducted under the AOC. In case the nominated person's licence and ratings are not current, his/her deputy should hold a valid flight crew licence and the associated ratings.
- (d) Crew training. The nominated person or his/her deputy should be a current type rating instructor on a type/class operated under the AOC. The nominated person should have a thorough knowledge of the AOC holder's crew training concept for flight, cabin and when relevant other crew.
- (e) Ground operations. The nominated person should have a thorough knowledge of the AOC holder's ground operations concept.
- (f) Continuing airworthiness. The nominated person should have the relevant knowledge and appropriate experience requirements related to aircraft continuing airworthiness as detailed in Part-M¹².

¹² Commission Regulation (EC) No 2042/2003 of 20 November 2003 on the continuing airworthiness of aircraft and aeronautical products, parts and appliances, and on the approval of organisations and personnel involved in these tasks (OJ L 315, 28.11.2003, p. 1). Regulation as last amended by Commission Regulation (EU) No 1149/2011 of 21 October 2011 (OJ L 298, 16.11.2011, p. 1).

ORO.AOC.140 Facility requirements

In accordance with ORO.GEN.215, the operator shall:

- (a) make use of appropriate ground handling facilities to ensure the safe handling of its flights;
- (b) arrange operational support facilities at the main operating base, appropriate for the area and type of operation; and
- (c) ensure that the available working space at each operating base is sufficient for personnel whose actions may affect the safety of flight operations. Consideration shall be given to the needs of ground crew, personnel concerned with operational control, the storage and display of essential records and flight planning by crews.

GM1 ORO.AOC.140(b);(c) Facility requirements

VFR DAY OPERATIONS WITH AEROPLANES WITH A MOPSC OF LESS THAN 7 AND HELICOPTERS WITH A MOPSC OF LESS THAN 5 TAKING OFF AND LANDING AT THE SAME AERODROME OR OPERATING SITE

Taking into account the size of the operator and the type of operations, appropriate facilities may consist in arrangements for:

- (a) suitable office accommodation for the nominated person(s), as requested by ORO.AOC.135, and
- (b) adequate working space for the flight preparation to be performed by the flight crew.

ORO.AOC.150 Documentation requirements

- (a) The operator shall make arrangements for the production of manuals and any other documentation required and associated amendments.
- (b) The operator shall be capable of distributing operational instructions and other information without delay.

SUBPART DEC: DECLARATION

ORO.DEC.100 Declaration

The operator of complex motor-powered aircraft engaged in non-commercial operations or non-commercial specialised operations, and the commercial specialised operator shall:

- (a) provide the competent authority with all relevant information prior to commencing operations, using the form contained in Appendix I to this Annex;
- (b) notify to the competent authority a list of the alternative means of compliance used;
- (c) maintain compliance with the applicable requirements and with the information given in the declaration;
- (d) notify the competent authority without delay of any changes to its declaration or the means of compliance it uses through submission of an amended declaration using the form contained in Appendix I to this Annex; and
- (e) notify the competent authority when it ceases operation.

AMC1 ORO.DEC.100(d) Declaration

CHANGES

The new declaration should be submitted before the change becomes effective indicating the date as of which the change would apply.

GM1 ORO.DEC.100 Declaration

GENERAL

The intent of the declaration is to:

- (a) have the operator acknowledge its responsibilities under the applicable safety regulations and that it holds all necessary approvals;
- (b) inform the competent authority of the existence of an operator; and
- (c) enable the competent authority to fulfil its oversight responsibilities in accordance with ARO.GEN.300 and 305.

MANAGED OPERATIONS

When the non-commercial operation of a complex motor-powered aircraft is managed by a third party on behalf of the owner, that party may be the operator in the sense of Article 3(h) of Regulation (EC) No 216/2008, and therefore has to declare its capability and means to discharge the responsibilities associated with the operation of the aircraft to the competent authority.

In such a case, it should also be assessed whether the third party operator undertakes a commercial operation in the sense of Article 3(i) of Regulation (EC) 216/2008.

SUBPART SPO: COMMERCIAL SPECIALISED OPERATIONS

ORO.SPO.100 Common requirements for commercial specialised operators

- (a) A commercial specialised operator shall in addition to ORO.DEC.100 also comply with ORO.AOC.135, ORO.AOC.140 and ORO.AOC.150.
- (b) Aircraft shall have a certificate of airworthiness (CofA) in accordance with Regulation (EU) No 748/2012 or shall be leased-in in accordance with (c).
- (c) A commercial specialised operator shall obtain prior approval of the competent authority and comply with the following conditions, if:
 - (1) Wet leasing-in an aircraft of a third country operator:
 - (i) The safety standards of a third country operator with regard to continuing airworthiness and air operations are equivalent to the applicable requirements established by Regulation (EC) No 2042/2003 and this Regulation;
 - (ii) The aircraft of a third country operator has a standard CofA issued in accordance with ICAO Annex 8;
 - (iii) The duration of the wet lease-in does not exceed seven months in any 12 consecutive month period; or
 - (2) Dry leasing-in an aircraft registered in a third country:
 - (i) An operational need has been identified that cannot be satisfied through leasing an aircraft registered in the EU;
 - (ii) The duration of the dry lease-in does not exceed seven months in any 12 consecutive month period;
 - (iii) Compliance with the applicable requirements of Regulation (EC) No 2042/2003 is ensured;
 - (iv) The aircraft is equipped in accordance with Annex VIII [Part SPO].

AMC1 ORO.SPO.100(a) Personnel requirements

NOMINATED PERSONS

- (a) The person may hold more than one of the nominated posts if such an arrangement is considered suitable and properly matched to the scale and scope of the commercial specialised operation.
- (b) A description of the functions and the responsibilities of the nominated persons, including their names, should be contained in the operations manual.
- (c) A commercial specialised operator should make arrangements to ensure continuity of supervision in the absence of nominated persons.
- (d) The person nominated by a commercial specialised operator should normally not be nominated by another commercial specialised operator.
- (e) Persons nominated should be contracted to work sufficient hours to fulfil the management functions associated with the scale and scope of the commercial specialised operation.

AMC2 ORO.SPO.100(a) Personnel requirements

COMBINATION OF NOMINATED PERSONS RESPONSIBILITIES

- (a) The acceptability of a single person holding several posts, possibly in combination with being the accountable manager, should depend upon the nature and scale of the commercial specialised operation. The two main areas of concern should be competence and an individual's capacity to meet his/her responsibilities.
- (b) As regards competence in different areas of responsibility, there should not be any difference from the requirements applicable to persons holding only one post.
- (c) The capacity of an individual to meet his/her responsibilities should primarily be dependent upon the scale of the commercial specialised operation. However, the complexity of the organisation or of the operation may prevent, or limit, combinations of posts which may be acceptable in other circumstances.
- (d) In most circumstances, the responsibilities of a nominated person should rest with a single individual. However, in the area of ground operations, it may be acceptable for responsibilities to be split, provided that the responsibilities of each individual concerned are clearly defined.

GM1 ORO.SPO.100(a) Personnel requirements

NOMINATED PERSONS

The smallest organisation that can be considered is the one-man organisation where all of the nominated posts are filled by the accountable manager, and audits are conducted by an independent person.

GM2 ORO.SPO.100(a) Personnel requirements

COMPETENCE OF NOMINATED PERSONS

- (a) Nominated persons in accordance with ORO.AOC.135 should normally be expected to possess the experience and meet the licensing provisions that are listed in (b) to (f). There may be exceptional cases where not all of the provisions can be met. In that circumstance, the nominee should have comparable experience and also the ability to perform effectively the functions associated with the post and with the scale of the specialised operation.
- (b) Nominated persons should have:
 - (1) practical experience and expertise in the application of aviation safety standards and safe operating practices;
 - (2) comprehensive knowledge of:
 - (i) the applicable EU safety regulations and any associated requirements and procedures;
 - (ii) the operator's high-risk specialised operation authorisation, if applicable; and
 - (iii) the need for, and content of, the relevant parts of the commercial specialised operator's operations manual;
 - (3) familiarity with management systems preferably in the area of aviation;
 - (4) appropriate management experience, preferably in a comparable organisation; and

- (5) 5 years of relevant work experience of which at least 2 years should be from the aeronautical industry in an appropriate position.
- (c) Flight operations. The nominated person should hold or have held a valid flight crew licence and the associated ratings appropriate to the type of commercial specialised operations conducted by the operator. In case the nominated person's licence and ratings are not current, his/her deputy should hold a valid flight crew licence and the associated ratings.
- (d) Crew training. The nominated person or his/her deputy should be a current type rating instructor on a type/class operated by the commercial specialised operator. The nominated person should have a thorough knowledge of the operator's crew training concept for flight crew and when relevant other crew.
- (e) Ground operations. The nominated person should have a thorough knowledge of the commercial specialised operator's ground operations concept.
- (f) Continuing airworthiness. The nominated person should have the relevant knowledge and appropriate experience requirements related to aircraft continuing airworthiness as detailed in Part-M¹³.

AMC1 ORO.SPO.100(c) Common requirements for commercial specialised operators**LEASING OF THIRD COUNTRY OPERATOR OR AIRCRAFT — INFORMATION TO BE PROVIDED TO THE COMPETENT AUTHORITY**

The operator intending to lease-in an aircraft or operator should provide the competent authority with the following information:

- (a) the aircraft type, registration markings and serial number;
- (b) the name and address of the registered owner;
- (c) a copy of the valid certificate of airworthiness;
- (d) a copy of the lease agreement or description of the lease provisions, except financial arrangements;
- (e) duration of the lease.

The information mentioned above should be accompanied by a statement signed by the lessee that the parties to the lease agreement fully understand their respective responsibilities under the applicable regulations.

GM1 ORO.SPO.100(c) Common requirements for commercial specialised operators**LEASE AGREEMENTS BETWEEN OPERATORS REGISTERED IN AN EU MEMBER STATE**

No approval is required for any lease agreements between operators having their principle place of business in an EU Member State.

¹³ Commission Regulation (EC) No 2042/2003 of 20 November 2003 on the continuing airworthiness of aircraft and aeronautical products, parts and appliances, and on the approval of organisations and personnel involved in these tasks (OJ L 315, 28.11.2003, p. 1). Regulation as last amended by Commission Regulation (EU) No 1149/2011 of 21 October 2011 (OJ L 298, 16.11.2011, p. 1).

AMC1 ORO.SPO.100(c)(1) Common requirements for commercial specialised operators

WET LEASE-IN OF AN AIRCRAFT REGISTERED IN A THIRD COUNTRY

If the operator is not intending to apply EU safety requirements for air operations and continuing airworthiness when wet leasing-in an aircraft registered in a third country, it should demonstrate to the competent authority that the standards complied with are equivalent to the following requirements:

- (a) Annex VIII (Part-SPO);
- (b) Part-ORO:
 - (1) ORO.GEN.110 and Section 2 of Subpart GEN;
 - (2) ORO.MLR, excluding ORO.MLR.105;
 - (3) ORO.FC;
- (c) Annex V (Part-SPA), if applicable;
- (d) for continuing airworthiness management of the third country operator, Part-M¹⁴ Subpart-B, Subpart-C and Subpart-G, excluding M.A.707, and M.A.710;
- (e) for the maintenance organisation used by the third country operator during the lease period: Part-145¹⁵; and
- (f) the operator should provide the competent authority with a full description of the operating procedures and safety assessment demonstrating compliance with the requirements safety objectives set out in points (b) (1)-(3).

AMC2 ORO.SPO.100(c)(1) Common requirements for commercial specialised operators

WET LEASE-IN

The lessee should maintain a record of occasions when lessors are used, for inspection by the competent authority.

GM1 ORO.SPO.100(c)(1) Common requirements for commercial specialised operators

SHORT-TERM WET LEASE-IN

In anticipation of an operational need the operator may enter into a framework agreement with more than one third country operator provided that these operators comply with ORO.SPO.110(c). These third country operators should be placed in a list maintained by the lessee.

¹⁴ Commission Regulation (EC) No 2042/2003 of 20 November 2003 on the continuing airworthiness of aircraft and aeronautical products, parts and appliances, and on the approval of organisations and personnel involved in these tasks (OJ L 315, 28.11.2003, p. 1). Regulation as last amended by Commission Regulation (EU) No 1149/2011 of 21 October 2011 (OJ L 298, 16.11.2011, p. 1).

¹⁵ Commission Regulation (EC) No 2042/2003 of 20 November 2003 on the continuing airworthiness of aircraft and aeronautical products, parts and appliances, and on the approval of organisations and personnel involved in these tasks (OJ L 315, 28.11.2003, p. 1). Regulation as last amended by Commission Regulation (EU) No 1149/2011 of 21 October 2011 (OJ L 298, 16.11.2011, p. 1).

ORO.SPO.110 Authorisation of high risk commercial specialised operations

- (a) A commercial specialised operator shall apply for and obtain an authorisation issued by the competent authority of the operator prior to commencing a high risk commercial specialised operation:
- (1) that is carried out over an area where the safety of third parties on the ground is likely to be endangered in the event of an emergency, or
 - (2) that, as determined by the competent authority of the place where the operation is conducted, due to its specific nature and the local environment in which it is conducted, poses a high risk, in particular to third parties on the ground.
- (b) The operator shall provide the following information to the competent authority:
- (1) the official name and business name, address, and mailing address of the applicant;
 - (2) a description of the management system, including organisational structure;
 - (3) a description of the proposed operation, including the type(s), and number of aircraft to be operated;
 - (4) the risk assessment documentation and related standard operating procedures, required by SPO.OP.230;
 - (5) a statement that all the documentation sent to the competent authority has been verified by the operator and found in compliance with the applicable requirements.
- (c) The application for an authorisation or its amendment shall be made in a form and manner established by the competent authority, taking into account the applicable requirements of Regulation (EC) No 216/2008 and its Implementing Rules.

GM1 ORO.SPO.110(a) Authorisation of high-risk commercial specialised operations

DECLARATION/AUTHORISATION

Any commercial specialised operator should declare its activity to its competent authority, as required by ORO.DEC.100.

GM2 ORO.SPO.110(a) Authorisation of high-risk commercial specialised operations

VALIDITY OF THE AUTHORISATION

The operator may submit an application to its competent authority for a single event, a defined series of flights or for an unlimited duration, depending on the type of operations foreseen.

ORO.SPO.115 Changes

- (a) Any change affecting the scope of the authorisation or the authorised operations shall require prior approval of the competent authority. Any change not covered by the initial risk assessment, shall require the submission of an amended risk assessment and SOP to the competent authority.
- (b) The application for approval of a change shall be submitted before any such change takes place, in order to enable the competent authority to determine continued compliance with Regulation (EC) No 216/2008 and its Implementing Rules and to amend, if necessary, the authorisation. The operator shall provide the competent authority with any relevant documentation.
- (c) The change shall only be implemented upon receipt of formal approval by the competent authority in accordance with ARO.OPS.150.
- (d) The operator shall operate under the conditions prescribed by the competent authority during such changes, as applicable.

GM1 ORO.SPO.115(a) Changes

GENERAL

Any change to information contained in the authorisation, but not leading to an amendment of the SOPs or the operator's risk assessment should be notified by the commercial specialised operator to its competent authority which should amend the authorisation.

ORO.SPO.120 Continued validity

- (a) An operator holding a specialised operation authorisation shall comply with the scope and privileges defined in the authorisation.
- (b) The operator's authorisation shall remain valid subject to:
 - (1) the operator remaining in compliance with the relevant requirements of Regulation (EC) No 216/2008 and its Implementing Rules, taking into account the provisions related to the handling of findings as specified under ORO.GEN.150;
 - (2) the competent authority being granted access to the operator as defined in ORO.GEN.140 to determine continued compliance with the relevant requirements of Regulation (EC) No 216/2008 and its Implementing Rules; and
 - (3) the authorisation not being surrendered or revoked.
- (c) Upon revocation or surrender the authorisation shall be returned to the competent authority without delay.

SUBPART MLR: MANUALS, LOGS AND RECORDS

ORO.MLR.100 Operations manual — general

- (a) The operator shall establish an operations manual (OM) as specified under 8.b of Annex IV to Regulation (EC) No 216/2008.
- (b) The content of the OM shall reflect the requirements set out in this Annex, Annex IV (Part-CAT), Annex V (Part-SPA), Annex VI (Part-NCC) and Annex VIII (Part-SPO), as applicable, and shall not contravene the conditions contained in the operations specifications to the air operator certificate (AOC), the SPO authorisation or the declaration and the list of specific approvals, as applicable.
- (c) The OM may be issued in separate parts.
- (d) All operations personnel shall have easy access to the portions of the OM that are relevant to their duties.
- (e) The OM shall be kept up to date. All personnel shall be made aware of the changes that are relevant to their duties.
- (f) Each crew member shall be provided with a personal copy of the relevant sections of the OM pertaining to their duties. Each holder of an OM, or appropriate parts of it, shall be responsible for keeping their copy up to date with the amendments or revisions supplied by the operator.
- (g) For AOC holders:
 - (1) for amendments required to be notified in accordance with ORO.GEN.115(b) and ORO.GEN.130(c), the operator shall supply the competent authority with intended amendments in advance of the effective date; and
 - (2) for amendments to procedures associated with prior approval items in accordance with ORO.GEN.130, approval shall be obtained before the amendment becomes effective.
- (g1) For SPO authorisation holders, any amendment associated with the authorised standard operating procedures, prior approval shall be obtained before the amendment becomes effective.
- (h) Notwithstanding (g) and (g1), when immediate amendments or revisions are required in the interest of safety, they may be published and applied immediately, provided that any approval required has been applied for.
- (i) The operator shall incorporate all amendments and revisions required by the competent authority.
- (j) The operator shall ensure that information taken from approved documents, and any amendment thereof, is correctly reflected in the OM. This does not prevent the operator from publishing more conservative data and procedures in the OM.
- (k) The operator shall ensure that all personnel are able to understand the language in which those parts of the OM which pertain to their duties and responsibilities are written. The content of the OM shall be presented in a form that can be used without difficulty and observes human factors principles.

AMC1 ORO.MLR.100 Operations manual — general

GENERAL

- (a) The operations manual (OM) may vary in detail according to the complexity of the operation and of the type and number of aircraft operated.
- (b) The OM or parts thereof may be presented in any form, including electronic form. In all cases, the accessibility, usability and reliability should be assured.
- (c) The OM should be such that:
 - (1) all parts of the manual are consistent and compatible in form and content;
 - (2) the manual can be readily amended; and
 - (3) the content and amendment status of the manual is controlled and clearly indicated.
- (d) The OM should include a description of its amendment and revision process specifying:
 - (1) the person(s) who may approve amendments or revisions;
 - (2) the conditions for temporary revisions and/or immediate amendments or revision required in the interest of safety; and
 - (3) the methods by which operator personnel are advised of the changes.
- (e) The OM content may be based on, or may refer to, industry codes of practice.
- (f) When compiling an OM, the operator may take advantage of the contents of other relevant documents. Material produced by the operator for the type-related part of the OM may be supplemented with, or substituted by, applicable parts of the aircraft flight manual (AFM) or, where such a document exists, by an aircraft operating manual produced by the manufacturer of the aircraft.
- (g) In the case of commercial operations with other-than-complex motor-powered aircraft or non-commercial operations, a 'pilot operating handbook' (POH), or equivalent document, may be used as the type-related part of the OM, provided that the POH covers the normal and abnormal/emergency operating procedures.
- (h) For the route and aerodrome part of the OM, material produced by the operator may be supplemented with or substituted by applicable route guide material produced by a specialist company.
- (i) If the operator chooses to use material from another source in the OM, either the applicable material should be copied and included directly in the relevant part of the OM, or the OM should contain a reference to the appropriate section of that applicable material.
- (j) If the operator chooses to make use of material from another source (e.g. a route manual producer, an aircraft manufacturer or a training organisation), this does not absolve the operator from the responsibility of verifying the applicability and suitability of this material. Any material received from an external source should be given its status by a statement in the OM.

AMC2 ORO.MLR.100 Operations manual — General

CONTENTS — NON-COMMERCIAL OPERATIONS WITH COMPLEX MOTOR-POWERED AIRCRAFT AND COMMERCIAL AIR TRANSPORT (CAT) OPERATIONS WITH SINGLE-ENGINED PROPELLER-DRIVEN AEROPLANES WITH A MOPSC OF 5 OR SINGLE ENGINED NON-COMPLEX HELICOPTERS WITH A MOPSC OF 5, TAKING OFF AND LANDING AT THE SAME AERODROME OR OPERATING SITE, UNDER VFR BY DAY AND CAT OPERATIONS WITH SAILPLANES AND BALLOONS

The OM should contain at least the following information, where applicable:

- (a) Table of contents;
- (b) Amendment control status and list of effective pages or paragraphs, unless the entire manual is re-issued and the manual has an effective date on it;
- (c) Duties, responsibilities and succession of management and operating personnel;
- (d) Description of the management system;
- (e) Operational control system;
- (f) Flight time limitations;
- (g) Standard operating procedures (SOPs);
- (h) Weather limitations;
- (i) Emergency procedures;
- (j) Accidents/incidents considerations;
- (k) Security procedures;
- (l) Minimum equipment list (MEL);
- (m) Personnel qualifications and training;
- (n) Record-keeping;
- (o) Normal flight operations;
- (p) Performance operating limitations;
- (q) Procedures for the preservation of recordings of the flight recorders in order to prevent inadvertent reactivation, repair or reinstallation of the flight recorders following an accident or a serious incident or when this preservation is directed by the investigating authority;
- (r) Handling of dangerous goods.

AMC3 ORO.MLR.100 Operations manual — general

CONTENTS — CAT OPERATIONS

- (a) The OM should contain at least the following information, where applicable, as relevant for the area and type of operation:
 - A GENERAL/BASIC
 - 0 ADMINISTRATION AND CONTROL OF OPERATIONS MANUAL
 - 0.1 Introduction:
 - (a) A statement that the manual complies with all applicable regulations and with the terms and conditions of the applicable AOC.

- (b) A statement that the manual contains operational instructions that are to be complied with by the relevant personnel.
- (c) A list and brief description of the various parts, their contents, applicability and use.
- (d) Explanations and definitions of terms and words needed for the use of the manual.

0.2 System of amendment and revision:

- (a) Details of the person(s) responsible for the issuance and insertion of amendments and revisions.
- (b) A record of amendments and revisions with insertion dates and effective dates.
- (c) A statement that handwritten amendments and revisions are not permitted, except in situations requiring immediate amendment or revision in the interest of safety.
- (d) A description of the system for the annotation of pages or paragraphs and their effective dates.
- (e) A list of effective pages or paragraphs.
- (f) Annotation of changes (in the text and, as far as practicable, on charts and diagrams).
- (g) Temporary revisions.
- (h) A description of the distribution system for the manuals, amendments and revisions.

1 ORGANISATION AND RESPONSIBILITIES

- 1.1 Organisational structure. A description of the organisational structure, including the general organogram and operations departments' organograms. The organogram should depict the relationship between the operations departments and the other departments of the operator. In particular, the subordination and reporting lines of all divisions, departments, etc., which pertain to the safety of flight operations, should be shown.
- 1.2 Nominated persons. The name of each nominated person responsible for flight operations, crew training and ground operations, as prescribed in ORO.AOC.135. A description of their function and responsibilities should be included.
- 1.3 Responsibilities and duties of operations management personnel. A description of the duties, responsibilities and authority of operations management personnel pertaining to the safety of flight operations and the compliance with the applicable regulations.
- 1.4 Authority, duties and responsibilities of the pilot-in-command/commander. A statement defining the authority, duties and responsibilities of the pilot-in-command/commander.
- 1.5 Duties and responsibilities of crew members other than the pilot-in-command/commander.

2 OPERATIONAL CONTROL AND SUPERVISION

- 2.1 Supervision of the operation by the operator. A description of the system for supervision of the operation by the operator (see ORO.GEN.110(c)). This should show how the safety of flight operations and the qualifications of personnel are supervised. In particular, the procedures related to the following items should be described:
 - (a) licence and qualification validity,
 - (b) competence of operations personnel,
 - (c) control, analysis and storage of the required records.
 - 2.2 System and responsibility for promulgation of additional operational instructions and information. A description of any system for promulgating information which may be of an operational nature, but which is supplementary to that in the OM. The applicability of this information and the responsibilities for its promulgation should be included.
 - 2.3 Operational control. A description of the procedures and responsibilities necessary to exercise operational control with respect to flight safety.
 - 2.4 Powers of the authority. A description of the powers of the competent authority and guidance to staff on how to facilitate inspections by authority personnel.
- 3 MANAGEMENT SYSTEM
- A description of the management system, including at least the following:
- (a) safety policy;
 - (b) the process for identifying safety hazards and for evaluating and managing the associated risks;
 - (c) compliance monitoring system;
 - (d) allocation of duties and responsibilities;
 - (e) documentation of all key management system processes.
- 4 CREW COMPOSITION
- 4.1 Crew composition. An explanation of the method for determining crew compositions, taking account of the following:
 - (a) the type of aircraft being used;
 - (b) the area and type of operation being undertaken;
 - (c) the phase of the flight;
 - (d) the minimum crew requirement and flight duty period planned;
 - (e) experience (total and on type), recency and qualification of the crew members;
 - (f) the designation of the pilot-in-command/commander and, if necessitated by the duration of the flight, the procedures for the relief of the pilot-in-command/commander or other members of the flight crew (see ORO.FC.105);
 - (g) the designation of the senior cabin crew member and, if necessitated by the duration of the flight, the procedures for the relief of the senior cabin crew member and any other member of the cabin crew.

-
- 4.2 Designation of the pilot-in-command/commander. The rules applicable to the designation of the pilot-in-command/commander.
 - 4.3 Flight crew incapacitation. Instructions on the succession of command in the event of flight crew incapacitation.
 - 4.4 Operation on more than one type. A statement indicating which aircraft are considered as one type for the purpose of:
 - (a) flight crew scheduling; and
 - (b) cabin crew scheduling.
- 5 QUALIFICATION REQUIREMENTS
- 5.1 A description of the required licence, rating(s), qualification/competency (e.g. for routes and aerodromes), experience, training, checking and recency for operations personnel to conduct their duties. Consideration should be given to the aircraft type, kind of operation and composition of the crew.
 - 5.2 Flight crew:
 - (a) pilot-in-command/commander,
 - (b) pilot relieving the pilot-in-command/commander,
 - (c) co-pilot,
 - (d) pilot relieving the co-pilot,
 - (e) pilot under supervision,
 - (f) system panel operator,
 - (g) operation on more than one type or variant.
 - 5.3 Cabin crew:
 - (a) senior cabin crew member,
 - (b) cabin crew member:
 - (i) required cabin crew member,
 - (ii) additional cabin crew member and cabin crew member during familiarisation flights,
 - (c) operation on more than one type or variant.
 - 5.4 Training, checking and supervision personnel:
 - (a) for flight crew; and
 - (b) for cabin crew.
 - 5.5 Other operations personnel (including technical crew and crew members other than flight, cabin and technical crew).
- 6 CREW HEALTH PRECAUTIONS
- 6.1 Crew health precautions. The relevant regulations and guidance to crew members concerning health, including the following:
 - (a) alcohol and other intoxicating liquids,
 - (b) narcotics,

- (c) drugs,
- (d) sleeping tablets,
- (e) anti-depressants,
- (f) pharmaceutical preparations,
- (g) immunisation,
- (h) deep-sea diving,
- (i) blood/bone marrow donation,
- (j) meal precautions prior to and during flight,
- (k) sleep and rest,
- (l) surgical operations.

7 FLIGHT TIME LIMITATIONS

7.1 Flight and duty time limitations and rest requirements.

7.2 Exceedance of flight and duty time limitations and/or reductions of rest periods. Conditions under which flight and duty time may be exceeded or rest periods may be reduced, and the procedures used to report these modifications.

8 OPERATING PROCEDURES

8.1 Flight preparation instructions. As applicable to the operation:

8.1.1 Minimum flight altitudes. A description of the method of determination and application of minimum altitudes including:

- (a) a procedure to establish the minimum altitudes/flight levels for visual flight rules (VFR) flights; and
- (b) a procedure to establish the minimum altitudes/flight levels for instrument flight rules (IFR) flights.

8.1.2 Criteria and responsibilities for determining the adequacy of aerodromes to be used.

8.1.3 Methods and responsibilities for establishing aerodrome operating minima. Reference should be made to procedures for the determination of the visibility and/or runway visual range (RVR) and for the applicability of the actual visibility observed by the pilots, the reported visibility and the reported RVR.

8.1.4 En-route operating minima for VFR flights or VFR portions of a flight and, where single-engined aircraft are used, instructions for route selection with respect to the availability of surfaces that permit a safe forced landing.

8.1.5 Presentation and application of aerodrome and en-route operating minima.

8.1.6 Interpretation of meteorological information. Explanatory material on the decoding of meteorological (MET) forecasts and MET reports relevant to the area of operations, including the interpretation of conditional expressions.

8.1.7 Determination of the quantities of fuel, oil and water methanol carried. The methods by which the quantities of fuel, oil and water methanol to be carried are determined and monitored in-flight. This section should also include instructions on the measurement and distribution of the fluid carried on

board. Such instructions should take account of all circumstances likely to be encountered on the flight, including the possibility of in-flight re-planning and of failure of one or more of the aircraft's power plants. The system for maintaining fuel and oil records should also be described.

8.1.8 Mass and centre of gravity. The general principles of mass and centre of gravity including the following:

- (a) definitions;
- (b) methods, procedures and responsibilities for preparation and acceptance of mass and centre of gravity calculations;
- (c) the policy for using standard and/or actual masses;
- (d) the method for determining the applicable passenger, baggage and cargo mass;
- (e) the applicable passenger and baggage masses for various types of operations and aircraft type;
- (f) general instructions and information necessary for verification of the various types of mass and balance documentation in use;
- (g) last-minute changes procedures;
- (h) specific gravity of fuel, oil and water methanol;
- (i) seating policy/procedures;
- (j) for helicopter operations, standard load plans.

8.1.9 Air traffic services (ATS) flight plan. Procedures and responsibilities for the preparation and submission of the ATS flight plan. Factors to be considered include the means of submission for both individual and repetitive flight plans.

8.1.10 Operational flight plan. Procedures and responsibilities for the preparation and acceptance of the operational flight plan. The use of the operational flight plan should be described, including samples of the operational flight plan formats in use.

8.1.11 Operator's aircraft technical log. The responsibilities and the use of the operator's aircraft technical log should be described, including samples of the format used.

8.1.12 List of documents, forms and additional information to be carried.

8.2 Ground handling instructions. As applicable to the operation:

8.2.1 Fuelling procedures. A description of fuelling procedures, including:

- (a) safety precautions during refuelling and defueling including when an auxiliary power unit is in operation or when rotors are running or when an engine is or engines are running and the prop-brakes are on;
- (b) refuelling and defuelling when passengers are embarking, on board or disembarking; and
- (c) precautions to be taken to avoid mixing fuels.

8.2.2 Aircraft, passengers and cargo handling procedures related to safety. A description of the handling procedures to be used when allocating seats,

embarking and disembarking passengers and when loading and unloading the aircraft. Further procedures, aimed at achieving safety whilst the aircraft is on the ramp, should also be given. Handling procedures should include:

- (a) special categories of passengers, including children/infants, persons with reduced mobility, inadmissible passengers, deportees and persons in custody;
- (b) permissible size and weight of hand baggage;
- (c) loading and securing of items in the aircraft;
- (d) positioning of ground equipment;
- (e) operation of aircraft doors;
- (f) safety on the aerodrome/operating site, including fire prevention and safety in blast and suction areas;
- (g) start-up, ramp departure and arrival procedures, including, for aeroplanes, push-back and towing operations;
- (h) servicing of aircraft;
- (i) documents and forms for aircraft handling;
- (j) special loads and classification of load compartments; and
- (k) multiple occupancy of aircraft seats.

8.2.3 Procedures for the refusal of embarkation. Procedures to ensure that persons who appear to be intoxicated, or who demonstrate by manner or physical indications that they are under the influence of drugs, are refused embarkation. This does not apply to medical patients under proper care.

8.2.4 De-icing and anti-icing on the ground. A description of the de-icing and anti-icing policy and procedures for aircraft on the ground. These should include descriptions of the types and effects of icing and other contaminants on aircraft whilst stationary, during ground movements and during take-off. In addition, a description of the fluid types used should be given, including the following:

- (a) proprietary or commercial names,
- (b) characteristics,
- (c) effects on aircraft performance,
- (d) hold-over times,
- (e) precautions during usage.

8.3 Flight Procedures:

8.3.1 VFR/IFR Policy. A description of the policy for allowing flights to be made under VFR, or for requiring flights to be made under IFR, or for changing from one to the other.

8.3.2 Navigation Procedures. A description of all navigation procedures, relevant to the type(s) and area(s) of operation. Special consideration should be given to:

- (a) standard navigational procedures, including policy for carrying out independent cross-checks of keyboard entries where these affect the flight path to be followed by the aircraft; and
 - (b) required navigation performance (RNP), minimum navigation performance specification (MNPS) and polar navigation and navigation in other designated areas;
 - (c) in-flight re-planning;
 - (d) procedures in the event of system degradation; and
 - (e) reduced vertical separation minima (RVSM), for aeroplanes.
- 8.3.3 Altimeter setting procedures, including, where appropriate, use of:
- (a) metric altimetry and conversion tables; and
 - (b) QFE operating procedures.
- 8.3.4 Altitude alerting system procedures for aeroplanes or audio voice alerting devices for helicopters.
- 8.3.5 Ground proximity warning system (GPWS)/terrain avoidance warning system (TAWS), for aeroplanes. Procedures and instructions required for the avoidance of controlled flight into terrain, including limitations on high rate of descent near the surface (the related training requirements are covered in OM-D 2.1).
- 8.3.6 Policy and procedures for the use of traffic collision avoidance system (TCAS)/airborne collision avoidance system (ACAS) for aeroplanes and, when applicable, for helicopters.
- 8.3.7 Policy and procedures for in-flight fuel management.
- 8.3.8 Adverse and potentially hazardous atmospheric conditions. Procedures for operating in, and/or avoiding, adverse and potentially hazardous atmospheric conditions, including the following:
- (a) thunderstorms,
 - (b) icing conditions,
 - (c) turbulence,
 - (d) windshear,
 - (e) jet stream,
 - (f) volcanic ash clouds,
 - (g) heavy precipitation,
 - (h) sand storms,
 - (i) mountain waves,
 - (j) significant temperature inversions.
- 8.3.9 Wake turbulence. Wake turbulence separation criteria, taking into account aircraft types, wind conditions and runway/final approach and take-off area (FATO) location. For helicopters, consideration should also be given to rotor downwash.

- 8.3.10 Crew members at their stations. The requirements for crew members to occupy their assigned stations or seats during the different phases of flight or whenever deemed necessary in the interest of safety and, for aeroplane operations, including procedures for controlled rest in the flight crew compartment.
- 8.3.11 Use of restraint devices for crew and passengers. The requirements for crew members and passengers to use safety belts and/or restraint systems during the different phases of flight or whenever deemed necessary in the interest of safety.
- 8.3.12 Admission to flight crew compartment. The conditions for the admission to the flight crew compartment of persons other than the flight crew. The policy regarding the admission of inspectors from an authority should also be included.
- 8.3.13 Use of vacant crew seats. The conditions and procedures for the use of vacant crew seats.
- 8.3.14 Incapacitation of crew members. Procedures to be followed in the event of incapacitation of crew members in-flight. Examples of the types of incapacitation and the means for recognising them should be included.
- 8.3.15 Cabin safety requirements. Procedures:
- (a) covering cabin preparation for flight, in-flight requirements and preparation for landing, including procedures for securing the cabin and galleys;
 - (b) to ensure that passengers are seated where, in the event that an emergency evacuation is required, they may best assist and not hinder evacuation from the aircraft;
 - (c) to be followed during passenger embarkation and disembarkation;
 - (d) when refuelling/defuelling with passengers embarking, on board or disembarking;
 - (e) covering the carriage of special categories of passengers;
 - (f) covering smoking on board;
 - (g) covering the handling of suspected infectious diseases.
- 8.3.16 Passenger briefing procedures. The contents, means and timing of passenger briefing in accordance with Annex IV (Part-CAT).
- 8.3.17 Procedures for aircraft operated whenever required cosmic or solar radiation detection equipment is carried.
- 8.3.18 Policy on the use of autopilot and autothrottle for aircraft fitted with these systems.
- 8.4 Low visibility operations (LVO). A description of the operational procedures associated with LVO.
- 8.5 Extended-range operations with two-engined aeroplanes (ETOPS). A description of the ETOPS operational procedures. (Refer to EASA AMC 20-6)
- 8.6 Use of the minimum equipment and configuration deviation list(s).

- 8.7 Non-revenue flights. Procedures and limitations, for example, for the following:
- (a) non-commercial operations by AOC holders, a description of the differences to commercial operations,
 - (b) training flights,
 - (c) test flights,
 - (d) delivery flights,
 - (e) ferry flights,
 - (f) demonstration flights,
 - (g) positioning flights, including the kind of persons who may be carried on such flights.

8.8 Oxygen requirements:

8.8.1 An explanation of the conditions under which oxygen should be provided and used.

8.8.2 The oxygen requirements specified for the following persons:

- (a) flight crew;
- (b) cabin crew;
- (c) passengers.

9 DANGEROUS GOODS AND WEAPONS

9.1 Information, instructions and general guidance on the transport of dangerous goods, in accordance with Subpart G of Annex V (SPA.DG), including:

- (a) operator's policy on the transport of dangerous goods;
- (b) guidance on the requirements for acceptance, labelling, handling, stowage and segregation of dangerous goods;
- (c) special notification requirements in the event of an accident or occurrence when dangerous goods are being carried;
- (d) procedures for responding to emergency situations involving dangerous goods;
- (e) duties of all personnel involved; and
- (f) instructions on the carriage of the operator's personnel on cargo aircraft when dangerous goods are being carried.

9.2 The conditions under which weapons, munitions of war and sporting weapons may be carried.

10 SECURITY

Security instructions, guidance, procedures, training and responsibilities, taking into account Regulation (EC) No 300/2008¹⁶. Some parts of the security instructions and guidance may be kept confidential.

11 HANDLING, NOTIFYING AND REPORTING ACCIDENTS, INCIDENTS AND OCCURRENCES AND USING THE CVR RECORDING

¹⁶ OJ L 97, 11.3.2008, p. 72.

Procedures for handling, notifying and reporting accidents, incidents and occurrences. This section should include the following:

- (a) definition of accident, incident and occurrence and of the relevant responsibilities of all persons involved;
- (b) illustrations of forms to be used for reporting all types of accident, incident and occurrence (or copies of the forms themselves), instructions on how they are to be completed, the addresses to which they should be sent and the time allowed for this to be done;
- (c) in the event of an accident, descriptions of which departments, authorities and other organisations have to be notified, how this will be done and in what sequence;
- (d) procedures for verbal notification to air traffic service units of incidents involving ACAS resolution advisories (RAs), bird hazards, dangerous goods and hazardous conditions;
- (e) procedures for submitting written reports on air traffic incidents, ACAS RAs, bird strikes, dangerous goods incidents or accidents, and unlawful interference;
- (f) reporting procedures. These procedures should include internal safety-related reporting procedures to be followed by crew members, designed to ensure that the pilot-in-command/commander is informed immediately of any incident that has endangered, or may have endangered, safety during the flight, and that the pilot-in-command/commander is provided with all relevant information.
- (g) Procedures for the preservation of recordings of the flight recorders following an accident or a serious incident or when so directed by the investigating authority. These procedures should include:
 - (1) a full quotation of CAT.GEN.MPA.195(a); and
 - (2) instructions and means to prevent inadvertent reactivation, repair or reinstallation of the flight recorders by personnel of the operator or of third parties, and to ensure that flight recorder recordings are preserved for the needs of the investigating authority.
- (h) Procedures required by CAT.GEN.MPA.195 for using the CVR recording or its transcript without prejudice to Regulation (EU) No 996/210, when applicable.

12 RULES OF THE AIR

- (a) Visual and instrument flight rules,
- (b) Territorial application of the rules of the air,
- (c) Communication procedures, including communication-failure procedures,
- (d) Information and instructions relating to the interception of civil aircraft,
- (e) The circumstances in which a radio listening watch is to be maintained,
- (f) Signals,
- (g) Time system used in operation,
- (h) ATC clearances, adherence to flight plan and position reports,
- (i) Visual signals used to warn an unauthorised aircraft flying in or about to enter a restricted, prohibited or danger area,

- (j) Procedures for flight crew observing an accident or receiving a distress transmission,
- (k) The ground/air visual codes for use by survivors, and description and use of signal aids,
- (l) Distress and urgency signals.

13 LEASING/CODE-SHARE

A description of the operational arrangements for leasing and code-share, associated procedures and management responsibilities.

B AIRCRAFT OPERATING MATTERS — TYPE RELATED

Taking account of the differences between types/classes, and variants of types, under the following headings:

0 GENERAL INFORMATION AND UNITS OF MEASUREMENT

- 0.1 General information (e.g. aircraft dimensions), including a description of the units of measurement used for the operation of the aircraft type concerned and conversion tables.

1 LIMITATIONS

1.1 A description of the certified limitations and the applicable operational limitations should include the following:

- (a) certification status (e.g. EASA (supplemental) type certificate, environmental certification, etc.);
- (b) passenger seating configuration for each aircraft type, including a pictorial presentation;
- (c) types of operation that are approved (e.g. VFR/IFR, CAT II/III, RNP, flights in known icing conditions, etc.);
- (d) crew composition;
- (e) mass and centre of gravity;
- (f) speed limitations;
- (g) flight envelope(s);
- (h) wind limits, including operations on contaminated runways;
- (i) performance limitations for applicable configurations;
- (j) (runway) slope;
- (k) for aeroplanes, limitations on wet or contaminated runways;
- (l) airframe contamination;
- (m) system limitations.

2 NORMAL PROCEDURES

The normal procedures and duties assigned to the crew, the appropriate checklists, the system for their use and a statement covering the necessary coordination procedures

between flight and cabin/other crew members. The normal procedures and duties should include the following:

- (a) pre-flight,
- (b) pre-departure,
- (c) altimeter setting and checking,
- (d) taxi, take-off and climb,
- (e) noise abatement,
- (f) cruise and descent,
- (g) approach, landing preparation and briefing,
- (h) VFR approach,
- (i) IFR approach,
- (j) visual approach and circling,
- (k) missed approach,
- (l) normal landing,
- (m) post-landing,
- (n) for aeroplanes, operations on wet and contaminated runways.

3 ABNORMAL AND/OR EMERGENCY PROCEDURES

The abnormal and/or emergency procedures and duties assigned to the crew, the appropriate checklists, the system for their use and a statement covering the necessary coordination procedures between flight and cabin/other crew members. The abnormal and/or emergency procedures and duties should include the following:

- (a) crew incapacitation,
- (b) fire and smoke drills,
- (c) for aeroplanes, un-pressurised and partially pressurised flight,
- (d) for aeroplanes, exceeding structural limits such as overweight landing,
- (e) lightning strikes,
- (f) distress communications and alerting ATC to emergencies,
- (g) engine/burner failure,
- (h) system failures,
- (i) guidance for diversion in case of serious technical failure,
- (j) ground proximity warning, including for helicopters audio voice alerting device (AVAD) warning,
- (k) ACAS/TCAS warning for aeroplanes/audio voice alerting device (AVAD) warning for helicopters,
- (l) windshear,
- (m) emergency landing/ditching,
- (n) for aeroplanes, departure contingency procedures.

4 PERFORMANCE

4.0 Performance data should be provided in a form that can be used without difficulty.

4.1 Performance data. Performance material that provides the necessary data for compliance with the performance requirements prescribed in Annex IV (Part-CAT). For aeroplanes, this performance data should be included to allow the determination of the following:

- (a) take-off climb limits — mass, altitude, temperature;
- (b) take-off field length (for dry, wet and contaminated runway conditions);
- (c) net flight path data for obstacle clearance calculation or, where applicable, take-off flight path;
- (d) the gradient losses for banked climb-outs;
- (e) en-route climb limits;
- (f) approach climb limits;
- (g) landing climb limits;
- (h) landing field length (for dry, wet and contaminated runway conditions) including the effects of an in-flight failure of a system or device, if it affects the landing distance;
- (i) brake energy limits;
- (j) speeds applicable for the various flight stages (also considering dry, wet and contaminated runway conditions).

4.1.1 Supplementary data covering flights in icing conditions. Any certified performance related to an allowable configuration, or configuration deviation, such as anti-skid inoperative.

4.1.2 If performance data, as required for the appropriate performance class, are not available in the AFM, then other data should be included. The OM may contain cross-reference to the data contained in the AFM where such data are not likely to be used often or in an emergency.

4.2 Additional performance data for aeroplanes. Additional performance data, where applicable, including the following:

- (a) all engine climb gradients,
- (b) drift-down data,
- (c) effect of de-icing/anti-icing fluids,
- (d) flight with landing gear down,
- (e) for aircraft with 3 or more engines, one-engine-inoperative ferry flights,
- (f) flights conducted under the provisions of the configuration deviation list (CDL).

5 FLIGHT PLANNING

5.1 Data and instructions necessary for pre-flight and in-flight planning including, for aeroplanes, factors such as speed schedules and power settings. Where applicable, procedures for engine(s)-out operations, ETOPS (particularly the one-engine-

inoperative cruise speed and maximum distance to an adequate aerodrome determined in accordance with Annex IV (Part-CAT)) and flights to isolated aerodromes should be included.

5.2 The method for calculating fuel needed for the various stages of flight.

5.3 When applicable, for aeroplanes, performance data for ETOPS critical fuel reserve and area of operation, including sufficient data to support the critical fuel reserve and area of operation calculation based on approved aircraft performance data. The following data should be included:

- (a) detailed engine(s)-inoperative performance data, including fuel flow for standard and non-standard atmospheric conditions and as a function of airspeed and power setting, where appropriate, covering:
 - (i) drift down (includes net performance), where applicable;
 - (ii) cruise altitude coverage including 10 000 ft;
 - (iii) holding;
 - (iv) altitude capability (includes net performance); and
 - (v) missed approach;
- (b) detailed all-engine-operating performance data, including nominal fuel flow data, for standard and non-standard atmospheric conditions and as a function of airspeed and power setting, where appropriate, covering:
 - (i) cruise (altitude coverage including 10 000 ft); and
 - (ii) holding;
- (c) details of any other conditions relevant to ETOPS operations which can cause significant deterioration of performance, such as ice accumulation on the unprotected surfaces of the aircraft, ram air turbine (RAT) deployment, thrust-reverser deployment, etc.; and
- (d) the altitudes, airspeeds, thrust settings, and fuel flow used in establishing the ETOPS area of operations for each airframe-engine combination should be used in showing the corresponding terrain and obstruction clearances in accordance with Annex IV (Part-CAT).

6 MASS AND BALANCE

Instructions and data for the calculation of the mass and balance, including the following:

- (a) calculation system (e.g. index system);
- (b) information and instructions for completion of mass and balance documentation, including manual and computer generated types;
- (c) limiting masses and centre of gravity for the types, variants or individual aircraft used by the operator;
- (d) dry operating mass and corresponding centre of gravity or index.

7 LOADING

Procedures and provisions for loading and unloading and securing the load in the aircraft.

8 CONFIGURATION DEVIATION LIST

The CDL(s), if provided by the manufacturer, taking account of the aircraft types and variants operated, including procedures to be followed when an aircraft is being dispatched under the terms of its CDL.

9 MINIMUM EQUIPMENT LIST (MEL)

The MEL for each aircraft type or variant operated and the type(s)/area(s) of operation. The MEL should also include the dispatch conditions associated with operations required for a specific approval (e.g. RNAV, RNP, RVSM, ETOPS). Consideration should be given to using the ATA number system when allocating chapters and numbers.

10 SURVIVAL AND EMERGENCY EQUIPMENT INCLUDING OXYGEN

10.1 A list of the survival equipment to be carried for the routes to be flown and the procedures for checking the serviceability of this equipment prior to take-off. Instructions regarding the location, accessibility and use of survival and emergency equipment and its associated checklist(s) should also be included.

10.2 The procedure for determining the amount of oxygen required and the quantity that is available. The flight profile, number of occupants and possible cabin decompression should be considered.

11 EMERGENCY EVACUATION PROCEDURES

11.1 Instructions for preparation for emergency evacuation, including crew coordination and emergency station assignment.

11.2 Emergency evacuation procedures. A description of the duties of all members of the crew for the rapid evacuation of an aircraft and the handling of the passengers in the event of a forced landing, ditching or other emergency.

12 AIRCRAFT SYSTEMS

A description of the aircraft systems, related controls and indications and operating instructions. Consideration should be given to use the ATA number system when allocating chapters and numbers.

C ROUTE/ROLE/AREA AND AERODROME/OPERATING SITE INSTRUCTIONS AND INFORMATION

1 Instructions and information relating to communications, navigation and aerodromes/operating sites, including minimum flight levels and altitudes for each route to be flown and operating minima for each aerodrome/operating site planned to be used, including the following:

- (a) minimum flight level/altitude;
- (b) operating minima for departure, destination and alternate aerodromes;
- (c) communication facilities and navigation aids;
- (d) runway/final approach and take-off area (FATO) data and aerodrome/operating site facilities;
- (e) approach, missed approach and departure procedures including noise abatement procedures;
- (f) communication-failure procedures;
- (g) search and rescue facilities in the area over which the aircraft is to be flown;

- (h) a description of the aeronautical charts that should be carried on board in relation to the type of flight and the route to be flown, including the method to check their validity;
- (i) availability of aeronautical information and MET services;
- (j) en-route communication/navigation procedures;
- (k) aerodrome/operating site categorisation for flight crew competence qualification;
- (l) special aerodrome/operating site limitations (performance limitations and operating procedures, etc.).

D TRAINING

- 1 Description of scope: Training syllabi and checking programmes for all operations personnel assigned to operational duties in connection with the preparation and/or conduct of a flight.
 - 2 Content: Training syllabi and checking programmes should include the following:
 - 2.1 for flight crew, all relevant items prescribed in Annex IV (Part-CAT), Annex V (Part-SPA) and ORO.FC;
 - 2.2 for cabin crew, all relevant items prescribed in Annex IV (Part-CAT), Annex V (Part-CC) of Commission Regulation (EU) 1178/2011 and ORO.CC;
 - 2.3 for technical crew, all relevant items prescribed in Annex IV (Part-CAT), Annex V (Part-SPA) and ORO.TC;
 - 2.4 for operations personnel concerned, including crew members:
 - (a) all relevant items prescribed in SPA.DG Subpart G of Annex IV (SPA.DG); and
 - (b) all relevant items prescribed in Annex IV (Part-CAT) and ORO.SEC; and
 - 2.5 for operations personnel other than crew members (e.g. dispatcher, handling personnel, etc.), all other relevant items prescribed in Annex IV (Part-CAT) and in this Annex pertaining to their duties.
 - 3 Procedures:
 - 3.1 Procedures for training and checking.
 - 3.2 Procedures to be applied in the event that personnel do not achieve or maintain the required standards.
 - 3.3 Procedures to ensure that abnormal or emergency situations requiring the application of part or all of the abnormal or emergency procedures, and simulation of instrument meteorological conditions (IMC) by artificial means are not simulated during CAT operations.
 - 4 Description of documentation to be stored and storage periods.
- (b) Notwithstanding (a), an OM that is compiled in accordance with JAR-OPS 3 amendment 5 may be considered to be compliant.
- (c) If there are sections that, because of the nature of the operation, do not apply, it is recommended that operators maintain the numbering system described in ORO.MLR.101 and above and insert 'Not applicable' or 'Intentionally blank' where appropriate.

AMC4 ORO.MLR.100 Operations manual — General**CONTENTS – NON-COMMERCIAL SPECIALISED OPERATIONS WITH COMPLEX MOTOR-POWERED AIRCRAFT AND COMMERCIAL SPECIALISED OPERATIONS**

- (a) The OM should contain at least the following information, where applicable, as relevant to the area and type of operation:

A GENERAL/BASIC

For chapters 0-7 refer to AMC3 ORO.MLR.100.

In addition:

- 6.2 The relevant regulations and guidance to crew members concerning dangerous goods used for specialised tasks (pesticides and chemicals, etc.).

8 OPERATING PROCEDURES

- 8.1 Flight preparation instructions. As applicable to the operation:

8.1.1 General procedures;

8.1.2 Minimum flight altitudes. A description of the method of determination and application of minimum altitudes, including a procedure to establish the minimum altitudes/flight levels;

8.1.3 Criteria and responsibilities for determining the adequacy of aerodromes/operating sites to be used;

8.1.4 Interpretation of meteorological information. Explanatory material on the decoding of MET forecasts and MET reports relevant to the area of operations, including the interpretation of conditional expressions;

8.1.5 Determination of the quantities of fuel, oil and water methanol carried. The methods by which the quantities of fuel, oil and water methanol to be carried are determined and monitored in-flight. The system for maintaining fuel and oil records should also be described;

8.1.6 Procedure for the determination of the mass of loads, the calculation of performance margins and the centre of gravity;

8.1.7 Emergency procedures, e.g. load, fuel or chemical jettison (to include the actions of all personnel);

8.1.8 System for supply of NOTAMS, meteorological and other safety-critical information both at base and in field locations;

8.1.9 Mandatory equipment for specific tasks (mirror, cargo sling, load cell, special radio equipment, radar altimeters, etc.);

8.1.10 Guidance on the CDL and MEL;

8.1.11 Policy on completion and carriage of documents including operator's aircraft technical log and journey log, or equivalent;

8.1.12 Any task-specific standard operating procedures not covered above.

- 8.2 Ground handling instructions. As applicable to the operation:

8.2.1 Briefing requirements for in-flight and ground task specialists;

8.2.2 Decontamination procedures;

- 8.2.3 Fuelling procedures, including safety precautions during refuelling and defuelling including quality checks required in the field location, precautions against spillage and environmental damage;
- 8.2.4. De-icing and anti-icing on the ground. A description of the de-icing and anti-icing policy and procedures for aircraft on the ground.
- 8.3 Flight procedures. As applicable to the operation:
 - 8.3.1 Procedures relevant to the aircraft type, specific task and area;
 - 8.3.2 Altimeter setting procedures;
 - 8.3.3 Actions following alerts from audio warning devices;
 - 8.3.4 GPWS/TAWS for aeroplanes. Procedures and instructions required for the avoidance of controlled flight into terrain, including limitations on high rate of descent near the surface (the related training requirements are covered in OM-D 2.1);
 - 8.3.5 Policy and procedures for the use of TCAS/ACAS for aeroplanes and, when applicable, for helicopters;
 - 8.3.6 Policy and procedures for in-flight fuel management;
 - 8.3.7 Procedures for operating in adverse and potentially hazardous atmospheric conditions;
 - 8.3.8 Wake turbulence and rotor downwash for helicopters;
 - 8.3.9 Use of restraint devices;
 - 8.3.10 Policy on use of vacant seats;
 - 8.3.11 Cabin safety requirements including smoking.
- 8.4 Task-specific weather limitations.
- 8.5 Use of the minimum equipment and configuration deviation list(s).
- 8.6 Oxygen requirements. An explanation of the conditions under which oxygen should be provided and used (altitude, exposure times, night etc.).
- 9 DANGEROUS GOODS AND WEAPONS
 - 9.1 Information, instruction and general guidance on the transport of dangerous goods as internal or external loads, including:
 - 9.1.1 The operator's policy on the transport of dangerous goods;
 - 9.1.2 Guidance on the requirements for acceptance, labelling, handling, stowage, and segregation of dangerous goods;
 - 9.1.3 Procedures for responding to emergency situations involving dangerous goods;
 - 9.1.4 Duties of all personnel involved; and
 - 9.1.5 Instructions on carriage of the operator's personnel on cargo aircraft when dangerous goods are being carried.
 - 9.2 The conditions under which weapons, munitions of war and sporting weapons may be carried.
- 10 SECURITY

Security instructions, guidance, procedures, training and responsibilities, taking into account Regulation (EC) No 300/2008. Some parts of the security instructions and guidance may be kept confidential.

11 HANDLING, NOTIFYING AND REPORTING ACCIDENTS, INCIDENTS AND OCCURRENCES, AND USING THE CVR RECORDINGS

Procedures for handling, notifying and reporting accidents, incidents and occurrences. This section should include:

11.1 Definitions of accidents and occurrences and responsibilities of all persons involved;

11.2 Reporting procedures (including any mandatory forms);

11.3 Special notification when dangerous goods are carried; and

11.4 Procedures for the preservation of recordings of the flight recorders in order to prevent inadvertent reactivation, repair or reinstallation of the flight recorders following an accident or a serious incident or when this preservation is directed by the investigating authority.

12 RULES OF THE AIR

In addition to the items referred to in AMC3 ORO.MLR.100, territorial procedures for obtaining permissions and exemptions, e.g. for underslung loads and lowflying clearances.

13 LEASING

Refer to AMC3 ORO.MLR.100.

B AIRCRAFT OPERATING MATTERS — TYPE RELATED

For chapters 0-1 refer to AMC3 ORO.MLR.100.

2 NORMAL PROCEDURES

The normal procedures and duties assigned to the crew, the appropriate checklists and the system for their use, including any task or specific role equipment procedures not contained in the AFM.

3 ABNORMAL AND/OR EMERGENCY PROCEDURES

The abnormal and/or emergency procedures and duties assigned to the crew, the appropriate checklists and the system for their use, including any task or specific role equipment emergency procedures not contained in the AFM.

4 PERFORMANCE

4.1 Performance data should be provided in a form in which it can be used without difficulty.

4.2 Performance data. Performance material which provides the necessary data for compliance with the performance requirements prescribed in Part-SPO.

5 FLIGHT PLANNING

5.1 Data and instructions necessary for pre-flight and in-flight planning.

5.2 Procedures for specialised tasks.

6 MASS AND BALANCE

Instructions and data for the calculation of the mass and balance, including:

- 6.1 Calculation system (e.g. index system);
- 6.2 Information and instructions for completion of mass and balance documentation; and
- 6.3 Limitations.

7 LOADING

Refer to AMC3 ORO.MLR.100.

8 CONFIGURATION DEVIATION LIST (CDL)

Refer to AMC3 ORO.MLR.100.

9 MINIMUM EQUIPMENT LIST (MEL)

The MEL for each aircraft type or variant operated and the type(s)/area(s) of operation. It should also contain procedures to be followed when an aircraft is being dispatched with one or more inoperative items, in accordance with the MEL.

10 SURVIVAL AND EMERGENCY EQUIPMENT INCLUDING OXYGEN

- 10.1 A list of the survival equipment to be carried, taking into account the nature of the area of operation, such as a hostile or a non-hostile environment.
- 10.2 A checklist for assessing the serviceability of the equipment and instructions for its use prior to take-off.
- 10.3 The procedure for determining the amount of oxygen required and the quantity that is available.

11 EMERGENCY EVACUATION PROCEDURES

- 11.1 Emergency evacuation procedures, crew coordination and occupant handling in the event of a forced landing, ditching or other emergency.

12 AIRCRAFT SYSTEMS

A description of the aircraft systems and all equipment specific to the tasks. Additional equipment, systems or fitting, related special procedures including any supplements to the AFM.

C TASKS AND OPERATING AREAS INSTRUCTIONS AND INFORMATION

Specific instructions related to the specialised tasks and operating areas in accordance with AMC3 ORO.MLR.100.

D TRAINING

- 1 Training syllabi and checking programmes for all operations personnel assigned to operational duties in connection with the preparation and/or conduct of a flight.
- 2 Training syllabi and checking programmes should include:
 - 2.1 For flight crew, all relevant items prescribed in Part-SPO, Part-SPA and this Part;
 - 2.2 For other crew members, all relevant items prescribed in Part-SPO and this Part, as applicable;

-
- 2.3 For in-flight and ground task specialists concerned, including crew members:
 - a. All relevant items prescribed in SPA.DG; and
 - b. All relevant items prescribed in Part-SPO and ORO.SEC; and
 - 2.4 For operations personnel other than crew members, all other relevant items pertaining to their duties prescribed in Part-SPO and this Part.
- 3 Procedures:
- 3.1 Procedures for training and checking.
 - 3.2 Procedures to be applied in the event that personnel do not achieve or maintain the required standards.
 - 3.3 A system for tracking expiry dates for qualifications, checks, tests, recency and licences.
- 4 Description of documentation to be stored and storage periods.
- (b) If there are sections that, because of the nature of the operation, do not apply, it is recommended that operators maintain the numbering system described in ORO.MLR.101 and above and insert 'Not applicable' or 'Intentionally blank' where appropriate.

GM1 ORO.MLR.100(k) Operations manual — general

HUMAN FACTORS PRINCIPLES

Guidance material on the application of human factors principles can be found in the ICAO Human Factors Training Manual (Doc 9683).

ORO.MLR.101 Operations manual — structure for commercial air transport

Except for operations with single engine propeller-driven aeroplanes with a MOPSC of 5 or single engine non-complex helicopters with a MOPSC of 5, taking off and landing at the same aerodrome or operating site, under VFR by day, and for operations with sailplanes and balloons, the main structure of the OM shall be as follows:

- (a) Part A: General/Basic, comprising all non-type-related operational policies, instructions and procedures;
- (b) Part B: Aircraft operating matters, comprising all type-related instructions and procedures, taking into account differences between types/classes, variants or individual aircraft used by the operator;
- (c) Part C: Commercial air transport operations, comprising route/role/area and aerodrome/operating site instructions and information;
- (d) Part D: Training, comprising all training instructions for personnel required for a safe operation.

ORO.MLR.105 Minimum equipment list

- (a) A minimum equipment list (MEL) shall be established as specified under point 8.a.3 of Annex IV to Regulation (EC) No 216/2008, based on the relevant master minimum equipment list (MMEL) as defined in the data established in accordance with Regulation (EU) No 748/2012. If an MMEL has not been established as part of the operational suitability data, the MEL may be based on the relevant MMEL accepted by the State of Operator or Registry as applicable.
- (b) The MEL and any amendment thereto shall be approved by the competent authority.
- (c) The operator shall amend the MEL after any applicable change to the MMEL within the acceptable timescales.
- (d) In addition to the list of items, the MEL shall contain:
 - (1) a preamble, including guidance and definitions for flight crews and maintenance personnel using the MEL;
 - (2) the revision status of the MMEL upon which the MEL is based and the revision status of the MEL;
 - (3) the scope, extent and purpose of the MEL.
- (e) The operator shall:
 - (1) establish rectification intervals for each inoperative instrument, item of equipment or function listed in the MEL. The rectification interval in the MEL shall not be less restrictive than the corresponding rectification interval in the MMEL;
 - (2) establish an effective rectification programme;
 - (3) only operate the aircraft after expiry of the rectification interval specified in the MEL when:
 - (i) the defect has been rectified; or
 - (ii) the rectification interval has been extended in accordance with (f).
- (f) Subject to approval of the competent authority, the operator may use a procedure for the one time extension of category B, C and D rectification intervals, provided that:
 - (1) the extension of the rectification interval is within the scope of the MMEL for the aircraft type;

- (2) the extension of the rectification interval is, as a maximum, of the same duration as the rectification interval specified in the MEL;
 - (3) the rectification interval extension is not used as a normal means of conducting MEL item rectification and is used only when events beyond the control of the operator have precluded rectification;
 - (4) a description of specific duties and responsibilities for controlling extensions is established by the operator;
 - (5) the competent authority is notified of any extension of the applicable rectification interval; and
 - (6) a plan to accomplish the rectification at the earliest opportunity is established.
- (g) The operator shall establish the operational and maintenance procedures referenced in the MEL taking into account the operational and maintenance procedures referenced in the MMEL. These procedures shall be part of the operator's manuals or the MEL.
- (h) The operator shall amend the operational and maintenance procedures referenced in the MEL after any applicable change to the operational and maintenance procedures referenced in the MMEL.
- (i) Unless otherwise specified in the MEL, the operator shall complete:
- (1) the operational procedures referenced in the MEL when planning for and/or operating with the listed item inoperative; and
 - (2) the maintenance procedures referenced in the MEL prior to operating with the listed item inoperative.
- (j) Subject to a specific case-by-case approval by the competent authority, the operator may operate an aircraft with inoperative instruments, items of equipment or functions outside the constraints of the MEL but within the constraints of the MMEL, provided that:
- (1) the concerned instruments, items of equipment or functions are within the scope of the MMEL as defined in point (a);
 - (2) the approval is not used as a normal means of conducting operations outside the constraints of the approved MEL and is used only when events beyond the control of the operator have precluded the MEL compliance;
 - (3) a description of specific duties and responsibilities for controlling the operation of the aircraft under such approval is established by the operator; and
 - (4) a plan to rectify the inoperative instruments, items of equipment or functions or to return operating the aircraft under the MEL constraints at the earliest opportunity is established.

GM1 ORO.MLR.105(a) Minimum equipment list

GENERAL

- (a) The Minimum Equipment List (MEL) is a document that lists the equipment that may be temporarily inoperative, subject to certain conditions, at the commencement of flight. This document is prepared by the operator for their own particular aircraft taking account of their aircraft configuration and all those individual variables that cannot be addressed at MMEL level, such as operating environment, route structure, geographic location, aerodromes where spare parts and maintenance capabilities are available, etc., in accordance with a procedure approved by the competent authority.

- (b) The MMEL, as defined in the mandatory part of the operational suitability data established in accordance with Commission Regulation (EU) No 748/2012, is developed in compliance with CS-MMEL or CS-GEN-MMEL. These Certification Specifications contain, among other, guidance intended to standardise the level of relief granted in MMELs, in particular for items that are subject to operational requirements. If a MMEL established as part of the operational suitability data is not available and items subject to operational requirements are listed in the available MMEL without specific relief or dispatch conditions but only with a reference to the operational requirements, the operator may refer to CS-MMEL or CS-GEN-MMEL guidance material, as applicable, to develop the relevant MEL content for such items.

NON-SAFETY-RELATED EQUIPMENT

- (a) Most aircraft are designed and certified with a significant amount of equipment redundancy, such that the airworthiness requirements are satisfied by a substantial margin. In addition, aircraft are generally fitted with equipment that is not required for safe operation under all operating conditions, e.g. instrument lighting in day VMC.
- (b) All items related to the airworthiness, or required for the safe operation, of the aircraft and not included in the list are automatically required to be operative.
- (c) Equipment, such as entertainment systems or galley equipment, may be installed for passenger convenience. If this non-safety-related equipment does not affect the airworthiness or operation of the aircraft when inoperative, it does not require a rectification interval, and need not be listed in the operator's MEL, if it is not addressed in the MMEL. The exceptions to this are as follows:
- (1) Where non-safety-related equipment serves a second function, such as movie equipment being used for cabin safety briefings, operators should develop and include operational contingency procedures in the MEL in case of an equipment malfunction.
 - (2) Where non-safety-related equipment is part of another aircraft system, for example the electrical system, procedures should be developed and included in the MEL for deactivating and securing in case of malfunction. In these cases, the item should be listed in the MEL, with compensating provisions and deactivation instructions if applicable. The rectification interval will be dependent on the secondary function of the item and the extent of its effect on other systems.
- (d) If the operator chooses to list non-safety-related equipment in the MEL, not listed in the MMEL, they should include a rectification interval category. These items may be given a 'D' category rectification interval provided any applicable (M) procedure (in the case of electrically supplied items) is applied.
- (e) Operators should establish an effective decision making process for failures that are not listed to determine if they are related to airworthiness and required for safe operation. In order for inoperative installed equipment to be considered non-safety-related, the following criteria should be considered:
- (1) the operation of the aircraft is not adversely affected such that standard operating procedures related to ground personnel, and crew members are impeded;
 - (2) the condition of the aircraft is not adversely affected such that the safety of passengers and/or personnel is jeopardised;
 - (3) the condition of the aircraft is configured to minimise the probability of a subsequent failure that may cause injury to passengers/personnel and/or cause damage to the aircraft;

- (4) the condition does not include the use of required emergency equipment and does not impact emergency procedures such that personnel could not perform them.

AMC1 ORO.MLR.105(c) Minimum equipment list**AMENDMENTS TO THE MEL FOLLOWING CHANGES TO THE MMEL — APPLICABLE CHANGES AND ACCEPTABLE TIMESCALES**

- (a) The following are applicable changes to the MMEL that require amendment of the MEL:
- (1) a reduction of the rectification interval;
 - (2) change of an item, only when the change is applicable to the aircraft or type of operations and is more restrictive.
- (b) An acceptable timescale for submitting the amended MEL to the competent authority is 90 days from the effective date specified in the approved change to the MMEL.
- (c) Reduced timescales for the implementation of safety-related amendments may be required if the Agency and/or the competent authority consider it necessary.

AMC1 ORO.MLR.105(d) Minimum equipment list**MEL FORMAT**

- (a) The MEL format and the presentation of items and dispatch conditions should reflect those of the MMEL.
- (b) The ATA 100/2200 Specification numbering system for MEL items is preferred.
- (c) Other formats and item numbering systems may be used provided they are clear and unambiguous.

AMC1 ORO.MLR.105(d)(1) Minimum equipment list**MEL PREAMBLE**

The MEL preamble should:

- (a) reflect the content of the MMEL preamble as applicable to the MEL scope and extent;
- (b) contain terms and definitions used in the MEL;
- (c) contain any other relevant specific information for the MEL scope and use that is not originally provided in the MMEL;
- (d) provide guidance on how to identify the origin of a failure or malfunction to the extent necessary for appropriate application of the MEL;
- (e) contain guidance on the management of multiple unserviceabilities, based on the guidance given in the MMEL; and
- (f) contain guidance on placarding of inoperative items to inform crew members of equipment condition, as appropriate. In particular, when such items are accessible to the crew during flight, the control(s) and indicator(s) related to inoperative unit(s) should be clearly placarded.

AMC1 ORO.MLR.105(d)(3) Minimum equipment list

SCOPE OF THE MEL

The MEL should include:

- (a) The dispatch conditions associated with flights conducted in accordance with special approvals held by the operator in accordance with Part-SPA.
- (b) Specific provision for particular types of operations carried out by the operator in accordance with ORO.AOC.125.

AMC2 ORO.MLR.105(d)(3) Minimum equipment list

EXTENT OF THE MEL

The operator should include guidance in the MEL on how to deal with any failures that occur between the commencement of the flight and the start of the take-off. If a failure occurs between the commencement of the flight and the start of the take-off, any decision to continue the flight should be subject to pilot judgement and good airmanship. The pilot-in-command/commander may refer to the MEL before any decision to continue the flight is taken.

GM1 ORO.MLR.105(d)(3) Minimum equipment list

SCOPE OF THE MEL

- (a) Examples of special approvals in accordance with Part-SPA may be:
 - (1) RVSM,
 - (2) ETOPS,
 - (3) LVO.
- (b) Examples of operations carried out by the operator in accordance with ORO.AOC.125 may be:
 - (1) crew training,
 - (2) positioning flights,
 - (3) demonstration flights.
- (c) When an aircraft has installed equipment which is not required for the operations conducted, the operator may wish to delay rectification of such items for an indefinite period. Such cases are considered to be out of the scope of the MEL, therefore modification of the aircraft is appropriate and deactivation, inhibition or removal of the item should be accomplished by an appropriate approved modification procedure.

GM2 ORO.MLR.105(d)(3) Minimum equipment list

PURPOSE OF THE MEL

The MEL is an alleviating document having the purpose to identify the minimum equipment and conditions to operate safely an aircraft having inoperative equipment. Its purpose is not, however, to encourage the operation of aircraft with inoperative equipment. It is undesirable for aircraft to be dispatched with inoperative equipment and such operations are permitted only as a result of careful analysis of each item to ensure that the acceptable level of safety, as intended in the applicable airworthiness and operational requirements is maintained. The continued operation of an aircraft in this condition should be minimised.

GM1 ORO.MLR.105(e);(f) Minimum equipment list

RECTIFICATION INTERVAL (RI)

The definitions and categories of rectification intervals are provided in CS-MMEL.

AMC1 ORO.MLR.105(f) Minimum equipment list

RECTIFICATION INTERVAL EXTENSION (RIE) — OPERATOR PROCEDURES FOR THE APPROVAL BY THE COMPETENT AUTHORITY AND NOTIFICATION TO THE COMPETENT AUTHORITY

- (a) The operator's procedures to address the extension of rectification intervals and ongoing surveillance to ensure compliance should provide the competent authority with details of the name and position of the nominated personnel responsible for the control of the operator's rectification interval extension (RIE) procedures and details of the specific duties and responsibilities established to control the use of RIEs.
- (b) Personnel authorising RIEs should be adequately trained in technical and/or operational disciplines to accomplish their duties. They should have necessary operational knowledge in terms of operational use of the MEL as alleviating documents by flight crew and maintenance personnel and engineering competence. The authorising personnel should be listed by appointment and name.
- (c) The operator should notify the competent authority within 1 month of the extension of the applicable rectification interval or within the appropriated timescales specified by the approved procedure for the RIE.
- (d) The notification should be made in a form determined by the competent authority and should specify the original defect, all such uses, the reason for the RIE and the reasons why rectification was not carried out within the original rectification interval.

GM1 ORO.MLR.105(f) Minimum equipment list

RECTIFICATION INTERVAL EXTENSION (RIE)

Procedures for the extension of rectification intervals should only be applied under certain conditions, such as a shortage of parts from manufacturers or other unforeseen situations (e.g. inability to obtain equipment necessary for proper troubleshooting and repair), in which case the operator may be unable to comply with the specified rectification intervals.

AMC1 ORO.MLR.105(g) Minimum equipment list

OPERATIONAL AND MAINTENANCE PROCEDURES

- (a) The operational and maintenance procedures referenced in the MEL should be based on the operational and maintenance procedures referenced in the MMEL. Modified procedures may, however, be developed by the operator when they provide the same level of safety, as required by the MMEL. Modified maintenance procedures should be developed in accordance with Commission Regulation (EC) No 2042/2003.
- (b) Providing appropriate operational and maintenance procedures referenced in the MEL, regardless of who developed them, is the responsibility of the operator.
- (c) Any item in the MEL requiring an operational or maintenance procedure to ensure an acceptable level of safety should be so identified in the 'remarks' or 'exceptions' column/part/section of

the MEL. This will normally be '(O)' for an operational procedure, or '(M)' for a maintenance procedure. '(O)(M)' means both operational and maintenance procedures are required.

- (d) The satisfactory accomplishment of all procedures, regardless of who performs them, is the responsibility of the operator.

GM1 ORO.MLR.105(g) Minimum equipment list

OPERATIONAL AND MAINTENANCE PROCEDURES

- (a) Operational and maintenance procedures are an integral part of the compensating conditions needed to maintain an acceptable level of safety, enabling the competent authority to approve the MEL. The competent authority may request presentation of fully developed (O) and/or (M) procedures in the course of the MEL approval process.
- (b) Normally, operational procedures are accomplished by the flight crew; however, other personnel may be qualified and authorised to perform certain functions.
- (c) Normally, maintenance procedures are accomplished by the maintenance personnel; however, other personnel may be qualified and authorised to perform certain functions in accordance with Commission Regulation (EC) No 2042/2003.
- (d) Operator's manuals may include the OM, the continued airworthiness management organisation manual (CAME) or other documents. Operational and maintenance procedures, regardless of the document where they are contained, should be readily available for use when needed for the application of the MEL.
- (e) Unless specifically permitted by a maintenance procedure, an inoperative item may not be removed from the aircraft.

AMC1 ORO.MLR.105(h) Minimum equipment list

OPERATIONAL AND MAINTENANCE PROCEDURES — APPLICABLE CHANGES

- (a) Changes to the operational and maintenance procedures referenced in the MMEL are considered applicable and require the amendment of the maintenance and operating procedures referenced in the MEL when:
- (1) the modified procedure is applicable to the operator's MEL; and
 - (2) the purpose of this change is to improve compliance with the intent of the associated MMEL dispatch condition.
- (b) An acceptable timescale for the amendments of maintenance and operating procedures, as defined in (a), should be 90 days from the date when the amended procedures referenced in the MMEL are made available. Reduced timescales for the implementation of safety related amendments may be required if the competent authority considers it necessary.

AMC1 ORO.MLR.105(j) Minimum equipment list

OPERATION OF AN AIRCRAFT WITHIN THE CONSTRAINTS OF THE MMEL — OPERATOR'S PROCEDURES FOR THE APPROVAL BY THE COMPETENT AUTHORITY

- (a) The operator's procedures to address the operation of an aircraft outside the constraints of the MEL but within the constraints of the MMEL and ongoing surveillance to ensure compliance should provide the competent authority with details of the name and position of the nominated

personnel responsible for the control of the operations under such conditions and details of the specific duties and responsibilities established to control the use of the approval.

- (b) Personnel authorising operations under such approval should be adequately trained in technical and operational disciplines to accomplish their duties. They should have the necessary operational knowledge in terms of operational use of the MEL as alleviating documents by flight crew and maintenance personnel and engineering competence. The authorising personnel should be listed by appointment and name.

GM1 ORO.MLR.105(j) Minimum equipment list

OPERATION OF AN AIRCRAFT WITHIN THE CONSTRAINTS OF THE MMEL — OPERATOR'S PROCEDURES FOR THE APPROVAL BY THE COMPETENT AUTHORITY

Procedures for the operation of an aircraft outside the constraints of the MEL but within the constraints of the MMEL should only be applied under certain conditions, such as a shortage of parts from manufacturers or other unforeseen situations (e.g. inability to obtain equipment necessary for proper troubleshooting and repair), in which case the operator may be unable to comply with the constraints specified in the MEL.

ORO.MLR.110 Journey log

Particulars of the aircraft, its crew and each journey shall be retained for each flight, or series of flights, in the form of a journey log, or equivalent.

AMC1 ORO.MLR.110 Journey log

GENERAL

- (a) The aircraft journey log, or equivalent, should include the following items, where applicable:
- (1) aircraft nationality and registration,
 - (2) date,
 - (3) name(s) of crew member(s),
 - (4) duty assignments of crew member(s),
 - (5) place of departure,
 - (6) place of arrival,
 - (7) time of departure,
 - (8) time of arrival,
 - (9) hours of flight,
 - (10) nature of flight (scheduled or non-scheduled),
 - (11) incidents, observations, if any,
 - (12) signature of person in charge.
- (b) The information, or parts thereof, may be recorded in a form other than on printed paper. Accessibility, usability and reliability should be assured.
- (c) ‘Journey log, or equivalent’ means that the required information may be recorded in documentation other than a log book, such as the operational flight plan or the aircraft technical log.
- (d) ‘Series of flights’ means consecutive flights, which begin and end:
- (1) within a 24-hour period;
 - (2) at the same aerodrome or operating site or remain within a local area specified in the operations manual; and
 - (3) with the same pilot-in-command/commander of the aircraft.

GM1 ORO.MLR.110 Journey log

SERIES OF FLIGHTS

The term ‘series of flights’ is used to facilitate a single set of documentation.

ORO.MLR.115 Record-keeping

- (a) The following records shall be stored for at least 5 years.
- (1) for CAT operators, records of the activities referred to in ORO.GEN.200;
 - (2) for declared operators, a copy of the operator's declaration, details of approvals held and operations manual;
 - (3) for SPO authorisation holders, in addition to (a)(2), records related to the risk assessment conducted in accordance with SPO.OP.230 and related standard operating procedures.
- (b) The following information used for the preparation and execution of a flight, and associated reports, shall be stored for three months:
- (1) the operational flight plan, if applicable;
 - (2) route-specific notice(s) to airmen (NOTAM) and aeronautical information services (AIS) briefing documentation, if edited by the operator;
 - (3) mass and balance documentation;
 - (4) notification of special loads, including written information to the commander/pilot-in-command about dangerous goods, if applicable;
 - (5) the journey log, or equivalent; and
 - (6) flight report(s) for recording details of any occurrence, or any event that the commander/pilot-in-command deems necessary to report or record;
- (c) Personnel records shall be stored for the periods indicated below:

Flight crew licence and cabin crew attestation	As long as the crew member is exercising the privileges of the licence or attestation for the aircraft operator
Crew member training, checking and qualifications	3 years
Records on crew member recent experience	15 months
Crew member route and aerodrome/task and area competence, as appropriate	3 years
Dangerous goods training, as appropriate	3 years
Training/qualification records of other personnel for whom a training programme is required	Last 2 training records

- (d) The operator shall:
- (1) maintain records of all training, checking and qualifications of each crew member, as prescribed in Part-ORO; and
 - (2) make such records available, on request, to the crew member concerned.
- (e) The operator shall preserve the information used for the preparation and execution of a flight and personnel training records, even if the operator ceases to be the operator of that aircraft or the employer of that crew member, provided this is within the timescales prescribed in (c).

-
- (f) If a crew member becomes a crew member for another operator, the operator shall make the crew member's records available to the new operator, provided this is within the timescales prescribed in (c).

AMC1 ORO.MLR.115 Record-keeping

TRAINING RECORDS

A summary of training should be maintained by the operator to show every crew member's completion of each stage of training and checking.

SUBPART SEC: SECURITY

ORO.SEC.100 Flight crew compartment security — aeroplanes

- (a) In an aeroplane which is equipped with a flight crew compartment door, this door shall be capable of being locked, and means shall be provided by which the cabin crew can notify the flight crew in the event of suspicious activity or security breaches in the cabin.
- (b) All passenger-carrying aeroplanes of a maximum certificated take-off mass exceeding 45500 kg, or with a MOPSC of more than 60 engaged in the commercial transportation of passengers, shall be equipped with an approved flight crew compartment door that is capable of being locked and unlocked from either pilot's station and designed to meet the applicable airworthiness requirements.
- (c) In all aeroplanes which are equipped with a flight crew compartment door in accordance with point (b) above:
 - (1) this door shall be closed prior to engine start for take-off and will be locked when required by security procedures or by the pilot-in-command until engine shut down after landing, except when deemed necessary for authorised persons to access or egress in compliance with national civil aviation security programmes; and
 - (2) means shall be provided for monitoring from either pilot's station the entire door area outside the flight crew compartment to identify persons requesting entry and to detect suspicious behaviour or potential threat.

ORO.SEC.105 Flight crew compartment security — helicopters

If installed, the flight crew compartment door on a helicopter operated for the purpose of carrying passengers shall be capable of being locked from within the flight crew compartment in order to prevent unauthorised access.

SUBPART FC: FLIGHT CREW

ORO.FC.005 Scope

This Subpart establishes requirements to be met by the operator related to flight crew training, experience and qualification and comprises:

- (a) SECTION 1 specifying common requirements applicable to both non-commercial operations of complex motor-powered aircraft and any commercial operation;
- (b) SECTION 2 specifying additional requirements applicable to commercial air transport operations, with the exception of:
 - (1) commercial air transport operations of sailplanes or balloons; or
 - (2) commercial air transport operations of passengers conducted under visual flight rules (VFR) by day, starting and ending at the same aerodrome or operating site and within a local area specified by the competent authority, with
 - single-engined propeller-driven aeroplanes having a maximum certified take-off mass of 5 700 kg or less and a MOPSC of 5, or
 - other-than complex motor-powered helicopters, single-engined, with a MOPSC of 5.
- (c) SECTION 3 specifying additional requirements for commercial specialised operations and for those referred to in b(1) and (2).

SECTION 1
Common requirements**ORO.FC.100 Composition of flight crew**

- (a) The composition of the flight crew and the number of flight crew members at designated crew stations shall be not less than the minimum specified in the aircraft flight manual or operating limitations prescribed for the aircraft.
- (b) The flight crew shall include additional flight crew members when required by the type of operation and shall not be reduced below the number specified in the operations manual.
- (c) All flight crew members shall hold a licence and ratings issued or accepted in accordance with Commission Regulation (EU) No 1178/2011¹⁷ and appropriate to the duties assigned to them.
- (d) The flight crew member may be relieved in flight of his/her duties at the controls by another suitably qualified flight crew member.
- (e) When engaging the services of flight crew members who are working on a freelance or part-time basis, the operator shall verify that all applicable requirements of this Subpart and the relevant elements of Annex I (Part-FCL) to Regulation (EU) No 1178/2011, including the requirements on recent experience, are complied with, taking into account all services rendered by the flight crew member to other operator(s) to determine in particular:
 - (1) the total number of aircraft types or variants operated; and
 - (2) the applicable flight and duty time limitations and rest requirements.

AMC1 ORO.FC.100(c) Composition of flight crew

OPERATIONAL MULTI-PILOT LIMITATION (OML)

The operator should ensure that pilots with an OML on their medical certificate only operate aircraft in multi-pilot operations when the other pilot is fully qualified on the relevant type of aircraft, is not subject to an OML and has not attained the age of 60 years.

¹⁷ OJ L 311, 25.11.2011, p. 1.

ORO.FC.105 Designation as pilot-in-command/commander

- (a) In accordance with 8.e of Annex IV to Regulation (EC) No 216/2008, one pilot amongst the flight crew, qualified as pilot-in-command in accordance with Annex I (Part-FCL) to Regulation (EU) No 1178/2011, shall be designated by the operator as pilot-in-command or, for commercial air transport operations, as commander.
- (b) The operator shall only designate a flight crew member to act as pilot-in-command/commander if he/she has:
- (1) the minimum level of experience specified in the operations manual;
 - (2) adequate knowledge of the route or area to be flown and of the aerodromes, including alternate aerodromes, facilities and procedures to be used;
 - (3) in the case of multi-crew operations, completed an operator's command course if upgrading from co-pilot to pilot-in-command/commander.
- (c) In the case of commercial operations of aeroplanes and helicopters, the pilot-in-command/commander or the pilot, to whom the conduct of the flight may be delegated, shall have had initial familiarisation training of the route or area to be flown and of the aerodromes, facilities and procedures to be used. This route/area and aerodrome knowledge shall be maintained by operating at least once on the route or area or to the aerodrome within a 12-month period.
- (d) Point (c) shall not apply in the case of:
- (1) performance class B aeroplanes involved in commercial air transport operations under VFR by day; and
 - (2) commercial air transport operations of passengers conducted under VFR by day, starting and ending at the same aerodrome or operating site or within a local area specified by the competent authority, with other-than complex motor-powered helicopters, single-engined, with a MOPSC of 5.

AMC1 ORO.FC.105(b)(2);(c) Designation as pilot-in-command/commander**ROUTE/AREA AND AERODROME KNOWLEDGE FOR COMMERCIAL OPERATIONS**

For commercial operations, the experience of the route or area to be flown and of the aerodrome facilities and procedures to be used should include the following:

- (a) Area and route knowledge
- (1) Area and route training should include knowledge of:
 - (i) terrain and minimum safe altitudes;
 - (ii) seasonal meteorological conditions;
 - (iii) meteorological, communication and air traffic facilities, services and procedures;
 - (iv) search and rescue procedures where available; and
 - (v) navigational facilities associated with the area or route along which the flight is to take place.
 - (2) Depending on the complexity of the area or route, as assessed by the operator, the following methods of familiarisation should be used:

- (i) for the less complex areas or routes, familiarisation by self-briefing with route documentation, or by means of programmed instruction; and
- (ii) in addition, for the more complex areas or routes, in-flight familiarisation as a pilot-in-command/commander or co-pilot under supervision, observer, or familiarisation in a flight simulation training device (FSTD) using a database appropriate to the route concerned.

(b) Aerodrome knowledge

- (1) Aerodrome training should include knowledge of obstructions, physical layout, lighting, approach aids and arrival, departure, holding and instrument approach procedures, applicable operating minima and ground movement considerations.
- (2) The operations manual should describe the method of categorisation of aerodromes and, in the case of CAT operations, provide a list of those aerodrome categorised as B or C.
- (3) All aerodromes to which an operator operates should be categorised in one of these three categories:
 - (i) category A — an aerodrome that meets all of the following requirements:
 - (A) an approved instrument approach procedure;
 - (B) at least one runway with no performance limited procedure for take-off and/or landing;
 - (C) published circling minima not higher than 1 000 ft above aerodrome level; and
 - (D) night operations capability.
 - (ii) category B — an aerodrome that does not meet the category A requirements or which requires extra considerations such as:
 - (A) non-standard approach aids and/or approach patterns;
 - (B) unusual local weather conditions;
 - (C) unusual characteristics or performance limitations; or
 - (D) any other relevant considerations, including obstructions, physical layout, lighting, etc.
 - (iii) category C — an aerodrome that requires additional considerations to a category B aerodrome;
 - (iv) offshore installations may be categorised as category B or C aerodromes, taking into account the limitations determined in accordance with AMC2 CAT.OP.MPA.105 'Use of aerodromes and operating sites'.
 - (iv) offshore installations may be categorised as category B or C aerodromes, taking into account the limitations determined in accordance with AMC1 SPA.HOFO.115 'Use of offshore locations'.

Applicable until 01/07/2018, then it will be replaced with the version below.

Applicable from 01/07/2018. Will replace the paragraph above.

(c) Prior to operating to a:

- (1) category B aerodrome, the pilot-in-command/commander should be briefed, or self-briefed by means of programmed instruction, on the category B aerodrome(s) concerned. The completion of the briefing should be recorded. This recording may be accomplished after completion or confirmed by the pilot-in-command/commander before departure on a flight involving category B aerodrome(s) as destination or alternate aerodromes.

- (2) category C aerodrome, the pilot-in-command/commander should be briefed and visit the aerodrome as an observer and/or undertake instruction in a suitable FSTD. The completion of the briefing, visit and/or instruction should be recorded.

GM1 ORO.FC.105 (b)(2) Route and aerodrome knowledge

ENVIRONMENTAL KNOWLEDGE RELATED TO THE PREVENTION OF AEROPLANE UPSETS

The knowledge should include understanding of:

- (a) the relevant environmental hazards, such as:
- Clear Air Turbulence (CAT),
 - Intertropical Convergence Zone (ITCZ),
 - thunderstorms,
 - microbursts,
 - wind shear,
 - icing,
 - mountain waves,
 - wake turbulence, and
 - temperature changes at high altitude;
- (b) the evaluation and management of the associated risks of the relevant hazards in (a); and
- (c) the available mitigating procedures for the relevant hazards in (a) related to the specific route, route area, or aerodrome used by the operator.

AMC1 ORO.FC.105(c) Designation as pilot-in-command/commander

ROUTE/AREA AND AERODROME RECENCY

- (a) The 12-month period should be counted from the last day of the month:
- (1) when the familiarisation training was undertaken; or
 - (2) of the latest operation on the route or area to be flown and of the aerodromes, facilities and procedures to be used.
- (b) When the operation is undertaken within the last 3 calendar months of that period, the new 12-month period should be counted from the original expiry date.

AMC2 ORO.FC.105(c) Designation as pilot-in-command/commander

ROUTE/AREA AND AERODROME RECENCY — PERFORMANCE CLASS B AEROPLANES OPERATED UNDER VFR BY NIGHT OR IFR IN CAT OPERATIONS AND COMMERCIAL OPERATIONS OTHER THAN CAT

In the case of CAT operations with performance class B aeroplanes operating under visual flight rules (VFR) by night or instrument flight rules (IFR), or commercial operations other than CAT, the knowledge should be maintained as follows:

- (a) except for operations to the most demanding aerodromes, by completion of at least 10 flight sectors within the area of operation during the preceding 12 months in addition to any required self-briefing;

-
- (b) operations to the most demanding aerodromes may be performed only if:
- (1) the pilot-in-command/commander has been qualified at the aerodrome within the preceding 36 months by a visit as an operating flight crew member or as an observer;
 - (2) the approach is performed in visual meteorological conditions (VMC) from the applicable minimum sector altitude; and
 - (3) an adequate self-briefing has been made prior to the flight.

GM1 ORO.FC.105(d) Designation as pilot-in-command/commander

PERFORMANCE CLASS B AEROPLANES OPERATED UNDER VFR BY DAY IN CAT OPERATIONS

For CAT operations under VFR by day with performance class B aeroplanes, the operator should take account of any requirement that might be stipulated in specific cases by the State of the aerodrome.

ORO.FC.110 Flight engineer

When a separate flight engineer station is incorporated in the design of an aeroplane, the flight crew shall include one crew member who is suitably qualified in accordance with applicable national rules.

ORO.FC.115 Crew resource management (CRM) training

- (a) Before operating, the flight crew member shall have received CRM training, appropriate to his/her role, as specified in the operations manual.
- (b) Elements of CRM training shall be included in the aircraft type or class training and recurrent training as well as in the command course.

AMC1 ORO.FC.115 Crew resource management (CRM) training

CRM TRAINING — MULTI-PILOT OPERATIONS

- (a) General
 - (1) Training environment

CRM training should be conducted in the non-operational environment (classroom and computer-based) and in the operational environment (flight simulation training device (FSTD) and aircraft). Tools such as group discussions, team task analysis, team task simulation and feedback should be used.
 - (2) Classroom training

Whenever possible, classroom training should be conducted in a group session away from the pressures of the usual working environment, so that the opportunity is provided for flight crew members to interact and communicate in an environment conducive to learning.
 - (3) Computer-based training

Computer-based training should not be conducted as a stand-alone training method, but may be conducted as a complementary training method.
 - (4) Flight simulation training devices (FSTDs)

Whenever practicable, parts of the CRM training should be conducted in FSTDs that reproduce a realistic operational environment and permit interaction. This includes but is not limited to line-oriented flight training (LOFT) scenarios.
 - (5) Integration into flight crew training

CRM principles should be integrated into relevant parts of flight crew training and operations including checklists, briefings, abnormal and emergency procedures.
 - (6) Combined CRM training for flight crew, cabin crew and technical crew
 - (i) Operators should provide combined training for flight crew, cabin crew and technical crew during recurrent CRM training.
 - (ii) The combined training should address at least:
 - (A) effective communication, coordination of tasks and functions of flight crew, cabin crew and technical crew; and
 - (B) mixed multinational and cross-cultural flight crew, cabin crew and technical crew, and their interaction, if applicable.

- (iii) The combined training should be expanded to include medical passengers, if applicable to the operation.
 - (iv) Combined CRM training should be conducted by flight crew CRM trainer or cabin crew CRM trainer.
 - (v) There should be an effective liaison between flight crew, cabin crew and technical crew training departments. Provision should be made for transfer of relevant knowledge and skills between flight crew, cabin crew and technical crew CRM trainers.
- (7) Management system
- CRM training should address hazards and risks identified by the operator's management system described in ORO.GEN.200.
- (8) Competency-based CRM training
- (i) Whenever practicable, the compliance-based approach concerning CRM training may be substituted by a competency-based approach such as evidence-based training. In this context, CRM training should be characterised by a performance orientation, with emphasis on standards of performance and their measurement, and the development of training to the specified performance standards.
 - (ii) CRM training should be an essential element of the alternative training and qualification programme (ATQP) described in ORO.FC.A.245, when the operator applies ATQP.
- (9) Contracted CRM training
- If the operator chooses not to establish its own CRM training, another operator, a third party or a training organisation may be contracted to provide the training in accordance with ORO.GEN.205. In case of contracted CRM training, the operator should ensure that the content of the course covers the specific culture, the type of operations and the associated procedures of the operator. When crew members from different operators attend the same course, the CRM training should be specific to the relevant flight operations and to the trainees concerned.
- (b) Initial operator's CRM training
- (1) The flight crew member should complete the initial operator's CRM training once. When the type of operation of a new operator is not different, the new operator should not be required to provide the initial operator's CRM training to this flight crew member a second time.
 - (2) The initial training should cover all elements specified in Table 1 of (g).
- (c) Operator conversion course — CRM training
- When the flight crew member undertakes a conversion course with a change of aircraft type or change of operator, elements of CRM training should be integrated into all appropriate phases of the operator's conversion course, as specified in Table 1 of (g).
- (d) Annual recurrent CRM training
- (1) Annual recurrent CRM training should be provided in such a way that all CRM training elements specified for the annual recurrent training in Table 1 of (g) are covered over a period not exceeding 3 years.

- (2) Operators should update their CRM recurrent training programme over a period not exceeding 3 years. The revision of the programme should take into account information from the operator's management system including the results of the CRM assessment.

(e) Command course — CRM training

The operator should ensure that elements of CRM training are integrated into the command course, as specified in Table 1 of (g).

(f) Training elements

The CRM training elements to be covered are specified in Table 1 of (g). The operator should ensure that the following aspects are addressed:

(1) Automation and philosophy on the use of automation

- (i) The CRM training should include training in the use and knowledge of automation, and in the recognition of systems and human limitations associated with the use of automation. The operator should, therefore, ensure that the flight crew member receives training on:

- (A) the application of the operations policy concerning the use of automation as stated in the operations manual; and
- (B) system and human limitations associated with the use of automation, giving special attention to issues of mode awareness, automation surprises and over-reliance including false sense of security and complacency.

- (ii) The objective of this training should be to provide appropriate knowledge, skills and attitudes for managing and operating automated systems. Special attention should be given to how automation increases the need for crews to have a common understanding of the way in which the system performs, and any features of automation that make this understanding difficult.

- (iii) If conducted in an FSTD, the training should include automation surprises of different origin (system- and pilot-induced).

(2) Monitoring and intervention

Flight crew should be trained in CRM-related aspects of operation monitoring before, during and after flight, together with any associated priorities. This CRM training should include guidance to the pilot monitoring on when it would be appropriate to intervene, if felt necessary, and how this should be done in a timely manner. Reference should be made to the operator procedures for structured intervention as specified in the operations manual.

(3) Resilience development

CRM training should address the main aspects of resilience development. The training should cover:

- (i) Mental flexibility

Flight crew should be trained to:

- (A) understand that mental flexibility is necessary to recognise critical changes;
- (B) reflect on their judgement and adjust it to the unique situation;
- (C) avoid fixed prejudices and over-reliance on standard solutions; and
- (D) remain open to changing assumptions and perceptions.

(ii) Performance adaptation

Flight crew should be trained to:

- (A) mitigate frozen behaviours, overreactions and inappropriate hesitation; and
- (B) adjust actions to current conditions.

(4) Surprise and startle effect

CRM training should address unexpected, unusual and stressful situations. The training should cover:

- (i) surprises and startle effects; and
- (ii) management of abnormal and emergency situations, including:
 - (A) the development and maintenance of the capacity to manage crew resources;
 - (B) the acquisition and maintenance of adequate automatic behavioural responses; and
 - (C) recognising the loss and re-building situation awareness and control.

(5) Cultural differences

CRM training should cover cultural differences of multinational and cross-cultural crews. This includes recognising that:

- (i) different cultures may have different communication specifics, ways of understanding and approaches to the same situation or problem;
- (ii) difficulties may arise when crew members with different mother tongue communicate in a common language which is not their mother tongue; and
- (iii) cultural differences may lead to different methods for identifying a situation and solving a problem.

(6) Operator's safety culture and company culture

CRM training should cover the operator's safety culture, its company culture, the type of operations and the associated procedures of the operator. This should include areas of operations that may lead to particular difficulties or involve unusual hazards.

(7) Case studies

- (i) CRM training should cover aircraft type-specific case studies, based on the information available within the operator's management system, including:
 - (A) accident and serious incident reviews to analyse and identify any associated non-technical causal and contributory factors, and instances or examples of lack of CRM; and
 - (B) analysis of occurrences that were well managed.
- (ii) If relevant aircraft type-specific or operator-specific case studies are not available, the operator should consider other case studies relevant to the scale and scope of its operations.

(g) CRM training syllabus

Table 1 below specifies which CRM training elements should be covered in each type of training. The levels of training in Table 1 can be described as follows:

- (1) ‘Required’ means training that should be instructional or interactive in style to meet the objectives specified in the CRM training programme or to refresh and strengthen knowledge gained in a previous training.
- (2) ‘In-depth’ means training that should be instructional or interactive in style taking full advantage of group discussions, team task analysis, team task simulation, etc., for the acquisition or consolidation of knowledge, skills and attitudes. The CRM training elements should be tailored to the specific needs of the training phase being undertaken.

Table 1: Flight crew CRM training

CRM training elements	Initial operator’s CRM training	Operator conversion course when changing aircraft type	Operator conversion course when changing operator	Annual recurrent training	Command course
General principles					
Human factors in aviation; General instructions on CRM principles and objectives; Human performance and limitations; Threat and error management.	In-depth	Required	Required	Required	Required
Relevant to the individual flight crew member					
Personality awareness, human error and reliability, attitudes and behaviours, self-assessment and self-critique; Stress and stress management; Fatigue and vigilance; Assertiveness, situation awareness, information acquisition and processing.	In-depth	Not required	Not required	Required	In-depth
Relevant to the flight crew					
Automation and philosophy on the use of automation	Required	In-depth	In-depth	In-depth	In-depth

CRM training elements	Initial operator's CRM training	Operator conversion course when changing aircraft type	Operator conversion course when changing operator	Annual recurrent training	Command course
Specific type-related differences	Required	In-depth	Not required	Required	Required
Monitoring and intervention	Required	In-depth	In-depth	Required	Required
Relevant to the entire aircraft crew					
Shared situation awareness, shared information acquisition and processing; Workload management; Effective communication and coordination inside and outside the flight crew compartment; Leadership, cooperation, synergy, delegation, decision-making, actions; Resilience development; Surprise and startle effect; Cultural differences.	In-depth	Required	Required	Required	In-depth
Relevant to the operator and the organisation					
Operator's safety culture and company culture, standard operating procedures (SOPs), organisational factors, factors linked to the type of operations; Effective communication and coordination with other operational personnel and ground services.	In-depth	Required	In-depth	Required	In-depth
Case studies	In-depth	In-depth	In-depth	In-depth	In-depth

(h) Assessment of CRM skills

- (1) Assessment of CRM skills is the process of observing, recording, interpreting and debriefing crews and crew member's performance using an accepted methodology in the context of the overall performance.
- (2) The flight crew member's CRM skills should be assessed in the operational environment, but not during CRM training in the non-operational environment. Nevertheless, during training in the non-operational environment, feedback from the flight crew CRM trainer or from trainees on individual and crew performance may be given to the crew members concerned.
- (3) The assessment of CRM skills should:
 - (i) include debriefing the crew and the individual crew member;
 - (ii) serve to identify additional training, where needed, for the crew or the individual crew member; and
 - (iii) be used to improve the CRM training system by evaluating de-identified summaries of all CRM assessments.
- (4) Prior to the introduction of CRM skills assessment, a detailed description of the CRM methodology, including the required CRM standards and the terminology used for the assessment, should be published in the operations manual.
- (5) Methodology of CRM skills assessment

The assessment should be based on the following principles:

 - (i) only observable behaviours are assessed;
 - (ii) the assessment should positively reflect any CRM skills that result in enhanced safety; and
 - (iii) assessments should include behaviour that results in an unacceptable reduction in safety margin.
- (6) Operators should establish procedures, including additional training, to be applied in the event that flight crew members do not achieve or maintain the required CRM standards.

AMC2 ORO.FC.115 Crew resource management (CRM) training**CRM TRAINING — SINGLE-PILOT OPERATIONS**

- (a) For single-pilot helicopter operations with technical crew, AMC1 ORO.FC.115 should be applied.
- (b) For single-pilot operations other than those specified in (a), AMC1 ORO.FC.115 should be applied with the following differences:
 - (1) Relevant training

Training should cover the relevant CRM training, i.e. initial operator's training, the operator conversion course and recurrent training.
 - (2) Relevant training elements

CRM training should focus on the elements specified in Table 1 of (g) of AMC1 ORO.FC.115 which are relevant to single-pilot operations. Therefore, single-pilot CRM training should include, among others:

 - (i) situation awareness;

- (ii) workload management;
 - (iii) decision-making;
 - (iv) resilience development;
 - (v) surprise and startle effect; and
 - (vi) effective communication and coordination with other operational personnel and ground services.
- (3) Computer-based training
- Notwithstanding (a)(3) of AMC1 ORO.FC.115, computer-based training may be conducted as a stand-alone training method.
- (4) Operation with ELA2 aircraft
- Notwithstanding (1) and (2), for operations with ELA2 aircraft the relevant CRM training and its duration should be determined by the operator, based on the aircraft type and the complexity of the operation.

AMC3 ORO.FC.115 Crew resource management (CRM) training

FLIGHT CREW CRM TRAINER

(a) Applicability

The provisions described herein:

- (1) should be fulfilled by flight crew CRM trainers responsible for classroom CRM training; and
- (2) are not applicable to:
 - (i) instructors, holding a certificate in accordance with Commission Regulation (EU) No 1178/2011, who conduct CRM training in the operational environment; and
 - (ii) trainers or instructors conducting training other than CRM training, but integrating CRM elements into this training.

(b) Qualification of flight crew CRM trainer

- (1) A training and standardisation programme for flight crew CRM trainers should be established.
- (2) A flight crew CRM trainer, in order to be suitably qualified, should:
 - (i) have adequate knowledge of the relevant flight operations;
 - (ii) have adequate knowledge of human performance and limitations (HPL), whilst:
 - (A) having obtained a commercial pilot licence in accordance with Commission Regulation (EU) No 1178/2011; or
 - (B) having followed a theoretical HPL course covering the whole syllabus of the HPL examination;
 - (iii) have completed flight crew initial operator's CRM training;
 - (iv) have received training in group facilitation skills;
 - (v) have received additional training in the fields of group management, group dynamics and personal awareness; and

- (vi) have demonstrated the knowledge, skills and credibility required to train the CRM training elements in the non-operational environment, as specified in Table 1 of AMC1 ORO.FC.115.
- (3) The following qualifications and experiences are also acceptable for a flight crew CRM trainer in order to be suitably qualified:
- (i) A flight crew member holding a recent qualification as a flight crew CRM trainer may continue to be a flight crew CRM trainer after the cessation of active flying duties if he/she maintains adequate knowledge of the relevant flight operations.
 - (ii) A former flight crew member may become a flight crew CRM trainer if he/she maintains adequate knowledge of the relevant flight operations and fulfils the provisions of (2)(ii) to (2)(vi).
 - (iii) An experienced CRM trainer may become a flight crew CRM trainer if he/she demonstrates adequate knowledge of the relevant flight operations and fulfils the provisions of (2)(ii) to (2)(vi).
- (c) Training of flight crew CRM trainer
- (1) Training of flight crew CRM trainers should be both theoretical and practical. Practical elements should include the development of specific trainer skills, particularly the integration of CRM into line operations.
 - (2) The basic training of flight crew CRM trainers should include the training elements for flight crew, as specified in Table 1 of AMC1 ORO.FC.115. In addition, the basic training should include the following:
 - (i) introduction to CRM training;
 - (ii) operator's management system;
 - (iii) characteristics, as applicable:
 - (A) of the different types of CRM trainings (initial, recurrent, etc.);
 - (B) of combined training; and
 - (C) related to the type of aircraft or operation; and
 - (iv) assessment.
 - (3) The refresher training of flight crew CRM trainers should include new methodologies, procedures and lessons learned.
 - (4) Instructors, holding a certificate in accordance with Commission Regulation (EU) No 1178/2011, who are also CRM trainers, may combine the CRM trainer refresher training with instructor refresher training.
 - (5) Instructors for other-than complex motor-powered aircraft should be qualified as flight crew CRM trainers for this aircraft category with no additional training, as specified in (2) and (3) when:
 - (i) holding a certificate in accordance with Commission Regulation (EU) No 1178/2011; and
 - (ii) fulfilling the provisions of (b)(2) or (b)(3).
 - (6) The training of flight crew CRM trainers should be conducted by flight crew CRM trainers with a minimum of 3 years' experience. Assistance may be provided by experts in order to address specific areas.

- (d) Assessment of flight crew CRM trainer
- (1) A flight crew CRM trainer should be assessed by the operator when conducting the first CRM training course. This first assessment should be valid for a period of 3 years.
 - (2) The operator should ensure that the process for the assessment is included in the operations manual describing methods for observing, recording, interpreting and debriefing the flight crew CRM trainer. All personnel involved in the assessment must be credible and competent in their role.
- (e) Recency and renewal of qualification as flight crew CRM trainer
- (1) For recency of the 3-year validity period, the flight crew CRM trainer should:
 - (i) conduct at least 2 CRM training events in any 12-month period;
 - (ii) be assessed within the last 12 months of the 3-year validity period by the operator; and
 - (iii) complete CRM trainer refresher training within the 3-year validity period.
 - (2) The next 3-year validity period should start at the end of the previous period.
 - (3) For renewal, i.e. when a flight crew CRM trainer does not fulfil the provisions of (1), he/she should, before resuming as flight crew CRM trainer:
 - (i) comply with the qualification provisions of (b) and (d); and
 - (ii) complete CRM trainer refresher training.

GM1 ORO.FC.115 Crew resource management (CRM) training

GENERAL

- (a) CRM is the effective utilisation of all available resources (e.g. crew members, aircraft systems, supporting facilities and persons) to achieve safe and efficient operation.
- (b) The objective of CRM is to enhance the communication and management skills of the flight crew member concerned. Emphasis is placed on the non-technical knowledge, skills and attitudes of flight crew performance.

GM2 ORO.FC.115 Crew resource management (CRM) training

TRAINING ENVIRONMENT, TRAINERS AND INSTRUCTORS

- (a) Flight crew CRM training can be separated as follows:
 - (1) training in the non-operational environment:
 - (i) classroom; and
 - (ii) computer-based;
 - (2) training in the operational environment:
 - (i) flight simulation training device (FSTD); and
 - (ii) aircraft.
- (b) In general, CRM training is provided as follows:
 - (1) classroom training by a flight crew CRM trainer;

- (2) training in the operational environment by an instructor holding a certificate in accordance with Commission Regulation (EU) No 1178/2011;
- (3) computer-based training as a self-study training method. If needed, directions concerning CRM-related issues are provided by a flight crew CRM trainer or by an instructor holding a certificate in accordance with Commission Regulation (EU) No 1178/2011.

GM3 ORO.FC.115 Crew resource management (CRM) training

MINIMUM TRAINING TIMES

- (a) The following minimum training times are appropriate:
 - (1) multi-pilot operations:
 - (i) combined CRM training: 6 training hours over a period of 3 years; and
 - (ii) initial operator's CRM training: 18 training hours with a minimum of 12 training hours in classroom training;
 - (2) initial operator's CRM training for single-pilot operations: 6 training hours; and
 - (3) flight crew CRM trainer:
 - (i) basic training:
 - (A) 18 training hours for trainees holding an instructor certificate for complex motor-powered aircraft, as specified in Commission Regulation (EU) No 1178/2011, which includes 25-hour training in teaching and learning; or
 - (B) 30 training hours for trainees who do not hold an instructor certificate as specified in (A); and
 - (ii) refresher training: 6 training hours.
- (b) 'Training hours' means actual training time excluding breaks and assessment.

GM4 ORO.FC.115 Crew resource management (CRM) training

DESIGN, IMPLEMENTATION AND EVALUATION OF CRM TRAINING

The checklist in Table 1 provides guidance on the design, implementation and evaluation of CRM training, and on their incorporation into the operator's safety culture. Elements of the operator's management systems and the competency-based approach are incorporated in the checklist.

Table 1 — Checklist for design, implementation, evaluation and incorporation of CRM training

Step No	Description	Element
1	Needs analysis	Determine the necessary CRM competencies
		Develop CRM training goals
		Ensure the organisation is ready for CRM training
2	Design	Develop CRM training objectives
		Determine what to measure and how to measure it
3	Development	Describe the CRM learning environment
		Develop full-scale prototype of training

Step No	Description	Element
		Validate and modify CRM training
4	Implementation	Prepare trainees and environment
		Set a climate for learning (e.g. practice and feedback)
		Implement the CRM training programme
5	Evaluation	Determine training effectiveness
		Evaluate CRM training at multiple levels
		Revise the CRM training programme to improve effectiveness
6	Incorporation	Establish an environment where CRM training is positively recognised
		Reinforce CRM behaviours in daily work
		Provide recurrent CRM training

GM5 ORO.FC.115 Crew resource management (CRM) training

RESILIENCE DEVELOPMENT

- (a) The main aspects of resilience development can be described as the ability to:
- (1) learn ('knowing what has happened');
 - (2) monitor ('knowing what to look for');
 - (3) anticipate ('finding out and knowing what to expect'); and
 - (4) respond ('knowing what to do and being capable of doing it').
- (b) Operational safety is a continuous process of evaluation of and adjustment to existing and future conditions. In this context, and following the description in (a), resilience development involves an ongoing and adaptable process including situation assessment, self-review, decision and action. Training in resilience development enables crew members to draw the right conclusions from both positive and negative experiences. Based on those experiences, crew members are better prepared to maintain or create safety margins by adapting to dynamic complex situations.
- (c) The training topics in (f)(3) of AMC1 ORO.FC.115 are to be understood as follows:
- (1) Mental flexibility
 - (i) The phrase 'understand that mental flexibility is necessary to recognise critical changes' means that crew members are prepared to respond to situations for which there is no set procedure.
 - (ii) The phrase 'reflect on their judgement and adjust it to the unique situation' means that crew members learn to review their judgement based on the unique characteristics of the given circumstances.
 - (iii) The phrase 'avoid fixed prejudices and over-reliance on standard solutions' means that crew members learn to update solutions and standard response sets, which have been formed on prior knowledge.
 - (iv) The phrase 'remain open to changing assumptions and perceptions' means that crew members constantly monitor the situation, and are prepared to adjust their understanding of the evolving conditions.

- (2) Performance adaptation
- (i) The phrase ‘mitigate frozen behaviours, overreactions and inappropriate hesitation’ means that crew members correct improper actions with a balanced response.
 - (ii) The phrase ‘adjust actions to current conditions’ means that crew members’ responses are in accordance with the actual situation.

GM6 ORO.FC.115 Crew resource management (CRM) training

NON-TECHNICAL SKILLS ASSESSMENT

- (a) NOTECHS (non-technical skills) is a validated method for assessing flight crew CRM skills. The NOTECHS framework consists of four main categories:
- (1) Cooperation: Cooperation is the ability to work effectively in a crew.
 - (2) Leadership and managerial skills: Effective leadership and managerial skills help to achieve joint task completion within a motivated, fully functioning team through coordination and persuasiveness.
 - (3) Situation awareness: Situation awareness relates to one’s ability to accurately perceive what is in the flight crew compartment and outside the aircraft. It is also one’s ability to comprehend the meaning of different elements in the environment and the projection of their status in the near future.
 - (4) Decision-making: Decision-making is the process of reaching a judgement or choosing an option.
- (b) Each of the four categories is subdivided into elements and behavioural markers. The elements are specified in Table 1 with examples of behavioural markers (effective behaviour). The behavioural markers are assessed by a rating scale to be established by the operator.

Table 1 — Categories, elements and behavioural markers of NOTECHS

Category	Element	Behavioural marker (examples)
Cooperation	Team building and maintaining	Establishes atmosphere for open communication and participation
	Considering others	Takes condition of other crew members into account
	Supporting others	Helps other crew members in demanding situations
	Conflict solving	Concentrates on what is right rather than who is right
Leadership and managerial skills	Use of authority and assertiveness	Takes initiative to ensure crew involvement and task completion
	Maintaining standards	Intervenes if task completion deviates from standards
	Planning and coordination	Clearly states intentions and goals
	Workload management	Allocates adequate time to complete tasks

Category	Element	Behavioural marker (examples)
Situation awareness	Awareness of aircraft systems	Monitors and reports changes in systems' states
	Awareness of external environment	Collects information about environment (position, weather and traffic)
	Anticipation	Identifies possible future problems
Decision-making	Problem definition and diagnosis	Reviews causal factors with other crew members
	Option generation	States alternative courses of action
		Asks other crew members for options
	Risk assessment and option selection	Considers and shares estimated risk of alternative courses of action
Outcome review	Checks outcome against plan	

GM7 ORO.FC.115 Crew resource management (CRM) training

FLIGHT CREW CRM TRAINER ASSESSMENT

- (a) For assessing flight crew CRM trainers, the operator may nominate experienced flight crew CRM trainers who have demonstrated continued compliance with the provisions for a flight crew CRM trainer and capability in that role for at least 3 years.
- (b) An operator that does not have the resources to conduct the assessment may employ a contractor. The standard as regards the assessment is confirmed on a 3-year basis by the operator.
- (c) The checklist in Table 1 provides guidance on the assessment of a flight crew CRM trainer. If a flight crew CRM trainer is competent in his/her role, the response to the questions in Table 1 should be 'yes'. When answering the questions in Table 1, justifications and examples related to the responses given should be provided.

Table 1 — Flight crew CRM trainer assessment checklist

Questions to assess a flight crew CRM trainer	Response yes/no
Did the CRM trainer demonstrate the knowledge required for the role?	
Did the CRM trainer support CRM concepts?	
Did the CRM trainer encourage trainees to participate, share their experiences and self-analyse?	
Did the CRM trainer identify and respond to the trainees' needs relative to expertise/experience?	
Did the CRM trainer show how CRM is integrated in technical training and line operations?	
Did the CRM trainer incorporate company CRM standards when appropriate?	

Questions to assess a flight crew CRM trainer	Response yes/no
Did the CRM trainer identify and discuss the non-technical reasons involved in accidents, incidents and events included in case studies?	
Did the CRM trainer regularly check for understanding and resolve ambiguities?	
Did the CRM trainer demonstrate effective instruction and facilitation skills?	

ORO.FC.120 Operator conversion training

- (a) In the case of aeroplane or helicopter operations, the flight crew member shall complete the operator conversion training course before commencing unsupervised line flying:
 - (1) when changing to an aircraft for which a new type or class rating is required;
 - (2) when joining an operator.
- (b) The operator conversion training course shall include training on the equipment installed on the aircraft as relevant to flight crew members' roles.

ORO.FC.125 Differences training and familiarisation training

- (a) Flight crew members shall complete differences or familiarisation training when required by Annex I (Part-FCL) to Regulation (EU) No 1178/2011 and when changing equipment or procedures requiring additional knowledge on types or variants currently operated.
- (b) The operations manual shall specify when such differences or familiarisation training is required.

AMC1 ORO.FC.125 Differences training and familiarisation training

GENERAL

- (a) Differences training requires additional knowledge and training on the aircraft or an appropriate training device. It should be carried out:
 - (1) when introducing a significant change of equipment and/or procedures on types or variants currently operated; and
 - (2) in the case of aeroplanes, when operating another variant of an aeroplane of the same type or another type of the same class currently operated; or
 - (3) in the case of helicopters, when operating a variant of a helicopter currently operated.
- (b) Familiarisation training requires only the acquisition of additional knowledge. It should be carried out when:
 - (1) operating another helicopter or aeroplane of the same type; or
 - (2) when introducing a significant change of equipment and/or procedures on types or variants currently operated.

ORO.FC.130 Recurrent training and checking

- (a) Each flight crew member shall complete annual recurrent flight and ground training relevant to the type or variant of aircraft on which he/she operates, including training on the location and use of all emergency and safety equipment carried.
- (b) Each flight crew member shall be periodically checked to demonstrate competence in carrying out normal, abnormal and emergency procedures.

ORO.FC.135 Pilot qualification to operate in either pilot's seat

Flight crew members who may be assigned to operate in either pilot's seat shall complete appropriate training and checking as specified in the operations manual.

ORO.FC.140 Operation on more than one type or variant

- (a) Flight crew members operating more than one type or variant of aircraft shall comply with the requirements prescribed in this Subpart for each type or variant, unless credits related to the training, checking, and recent experience requirements are defined in the mandatory part of the operational suitability data established in accordance with Regulation (EU) No 748/2012 for the relevant types or variants.
- (b) Appropriate procedures and/or operational restrictions shall be specified in the operations manual for any operation on more than one type or variant.

ORO.FC.145 Provision of training

- (a) All the training required in this Subpart shall be conducted:
 - (1) in accordance with the training programmes and syllabi established by the operator in the operations manual;
 - (2) by appropriately qualified personnel. In the case of flight and flight simulation training and checking, the personnel providing the training and conducting the checks shall be qualified in accordance with Annex I (Part-FCL) to Regulation (EU) No 1178/2011.
- (b) When establishing the training programmes and syllabi, the operator shall include the relevant elements defined in the mandatory part of the operational suitability data established in accordance with Regulation (EU) No 748/2012.
- (c) In the case of CAT operations, training and checking programmes, including syllabi and use of individual flight simulation training devices (FSTDs), shall be approved by the competent authority.
- (d) The FSTD shall replicate the aircraft used by the operator, as far as practicable. Differences between the FSTD and the aircraft shall be described and addressed through a briefing or training, as appropriate.
- (e) The operator shall establish a system to adequately monitor changes to the FSTD and to ensure that those changes do not affect the adequacy of the training programmes.

AMC1 ORO.FC.145(b) Provision of training

NON-MANDATORY (RECOMMENDATION) ELEMENTS OF OPERATIONAL SUITABILITY DATA

When developing the training programmes and syllabi, the operator should consider the non-mandatory (recommendation) elements for the relevant type that are provided in the operational suitability data established in accordance with Commission Regulation (EU) No 748/2012¹⁸.

AMC1 ORO.FC.145(d) Provision of training

FULL FLIGHT SIMULATORS (FFS)

The operator should classify any differences between the aircraft and FFS in accordance with the Air Transport Association (ATA) chapters as follows:

Compliance Levels

(a) Level A differences:

- (1) no influence on flight characteristics;
- (2) no influence on procedures (normal and/or abnormal);
- (3) differences in presentation; and
- (4) differences in operation.

Method: self-instruction via the operations manual or flight crew information.

(b) Level B differences:

- (1) no influence on flight characteristics;
- (2) influence on procedures (normal and/or abnormal); and
- (3) possible differences in presentation and operation.

Method: flight crew information, computer-based training, system device training or special instruction by instructor.

(c) Level C differences:

- (1) influence on flight characteristics;
- (2) influence on procedures (normal and/or abnormal); and
- (3) eventually differences in presentation and operation.

Method: special instruction by instructor, a selected partial training on another FSTD or aircraft or a waiver because of previous experience, special instruction or training programme.

(d) Level D differences:

- (1) influence on flight characteristics; and/or
- (2) influence on procedures (normal and/or abnormal); and/or
- (3) differences in presentation and/or operation; and
- (4) FSTD is level D qualified and is used for zero flight-time training (ZFTT).

Method: a specified partial training on another FSTD or aircraft or a waiver because of previous experience, special instruction or training programme.

¹⁸ OJ L 243, 27.9.2003, p. 6.

SECTION 2
Additional requirements for commercial air transport operations

ORO.FC.200 Composition of flight crew

- (a) There shall not be more than one inexperienced flight crew member in any flight crew.
- (b) The commander may delegate the conduct of the flight to another pilot suitably qualified in accordance with Annex I (Part-FCL) to Regulation (EU) No 1178/2011 provided that the requirements of ORO.FC.105(b)(1), (b)(2) and (c) are complied with.
- (c) Specific requirements for aeroplane operations under instrument flight rules (IFR) or at night.
 - (1) The minimum flight crew shall be two pilots for all turbo-propeller aeroplanes with a maximum operational passenger seating configuration (MOPSC) of more than nine and all turbojet aeroplanes.
 - (2) Aeroplanes other than those covered by (c)(1) shall be operated with a minimum crew of two pilots, unless the requirements of ORO.FC.202 are complied with, in which case they may be operated by a single pilot.
- (d) Specific requirements for helicopter operations.
 - (1) For all operations of helicopters with an MOPSC of more than 19 and for operations under IFR of helicopters with an MOPSC of more than 9:
 - (i) the minimum flight crew shall be two pilots; and
 - (ii) the commander shall be the holder of an airline transport pilot licence (helicopter) (ATPL(H)) with an instrument rating issued in accordance with Annex I (Part-FCL) to Regulation (EU) No 1178/2011.
 - (2) Operations not covered by (d)(1) may be operated by a single pilot under IFR or at night provided that the requirements of ORO.FC.202 are complied with.

AMC1 ORO.FC.200(a) Composition of flight crew**CREWING OF INEXPERIENCED FLIGHT CREW MEMBERS**

The operator should establish procedures in the operations manual taking into account the following elements:

Aeroplanes

- (a) The operator should consider that a flight crew member is inexperienced, following completion of a type rating or command course, and the associated line flying under supervision, until he/she has achieved on the type either:
 - (1) 100 flight hours and flown 10 sectors within a consolidation period of 120 consecutive days; or
 - (2) 150 flight hours and flown 20 sectors (no time limit).
- (b) A lesser number of flight hours or sectors, subject to any other conditions that the competent authority may impose, may be acceptable to the competent authority when one of the following applies:
 - (1) a new operator is commencing operations;

- (2) an operator introduces a new aeroplane type;
- (3) flight crew members have previously completed a type conversion course with the same operator;
- (4) credits are defined in the operational suitability data established in accordance with Commission Regulation (EU) No 748/2012; or
- (5) the aeroplane has a maximum take-off mass of less than 10 tonnes or a maximum operational passenger seating configuration (MOPSC) of less than 20.

Helicopters

- (c) The operator should consider that, when two flight crew members are required, a flight crew member, following completion of a type rating or command course, and the associated line flying under supervision, is inexperienced until either:
 - (1) he/she has achieved 50 flight hours on the type and/or in the role within a period of 60 days; or
 - (2) he/she has achieved 100 flight hours on the type and/or in the role (no time limit).
- (d) A lesser number of flight hours, on the type and/or in the role, and subject to any other conditions which the competent authority may impose, may be acceptable to the competent authority when one of the following applies:
 - (1) a new operator is commencing operations;
 - (2) an operator introduces a new helicopter type;
 - (3) flight crew members have previously completed a type conversion course with the same operator (reconversion); or
 - (4) credits are defined in the operational suitability data established in accordance with Commission Regulation (EU) No 748/2012.

ORO.FC.A.201 In-flight relief of flight crew members

- (a) The commander may delegate the conduct of the flight to:
- (1) another qualified commander; or
 - (2) for operations only above flight level (FL) 200, a pilot who complies with the following minimum qualifications:
 - (i) ATPL;
 - (ii) conversion training and checking, including type rating training, in accordance with ORO.FC.220;
 - (iii) all recurrent training and checking in accordance with ORO.FC.230 and ORO.FC.240;
 - (iv) route/area and aerodrome competence in accordance with ORO.FC.105.
- (b) The co-pilot may be relieved by:
- (1) another suitably qualified pilot;
 - (2) for operations only above FL 200, a cruise relief co-pilot that complies with the following minimum qualifications:
 - (i) valid commercial pilot licence (CPL) with an instrument rating;
 - (ii) conversion training and checking, including type rating training, in accordance with ORO.FC.220 except the requirement for take-off and landing training;
 - (iii) recurrent training and checking in accordance with ORO.FC.230 except the requirement for take-off and landing training.
- (c) A flight engineer may be relieved in flight by a crew member suitably qualified in accordance with applicable national rules.

ORO.FC.202 Single-pilot operations under IFR or at night

In order to be able to fly under IFR or at night with a minimum flight crew of one pilot, as foreseen in ORO.FC.200(c)(2) and (d)(2), the following shall be complied with:

- (a) The operator shall include in the operations manual a pilot's conversion and recurrent training programme that includes the additional requirements for a single-pilot operation. The pilot shall have undertaken training on the operator's procedures, in particular regarding:
- (1) engine management and emergency handling;
 - (2) use of normal, abnormal and emergency checklist;
 - (3) air traffic control (ATC) communication;
 - (4) departure and approach procedures;
 - (5) autopilot management, if applicable;
 - (6) use of simplified in-flight documentation;
 - (7) single-pilot crew resource management.
- (b) The recurrent checks required by ORO.FC.230 shall be performed in the single-pilot role on the relevant type or class of aircraft in an environment representative of the operation.
- (c) For aeroplane operations under IFR the pilot shall have:

- (1) a minimum of 50 hours flight time under IFR on the relevant type or class of aeroplane, of which 10 hours are as commander; and
 - (2) completed during the preceding 90 days on the relevant type or class of aeroplane:
 - (i) five IFR flights, including three instrument approaches, in a single-pilot role; or
 - (ii) an IFR instrument approach check.
- (d) For aeroplane operations at night the pilot shall have:
- (1) a minimum of 15 hours flight time at night which may be included in the 50 hours flight time under IFR in (c)(1); and
 - (2) completed during the preceding 90 days on the relevant type or class of aeroplane:
 - (i) three take-offs and landings at night in the single pilot role; or
 - (ii) a night take-off and landing check.
- (e) For helicopter operations under IFR the pilot shall have:
- (1) 25 hours total IFR flight experience in the relevant operating environment; and
 - (2) 25 hours flight experience as a single pilot on the specific type of helicopter, approved for single-pilot IFR, of which 10 hours may be flown under supervision, including five sectors of IFR line flying under supervision using the single-pilot procedures; and
 - (3) completed during the preceding 90 days:
 - (i) five IFR flights as a single pilot, including three instrument approaches, carried out on a helicopter approved for this purpose; or
 - (ii) an IFR instrument approach check as a single pilot on the relevant type of helicopter, flight training device (FTD) or full flight simulator (FFS).

ORO.FC.205 Command course

- (a) For aeroplane and helicopter operations, the command course shall include at least the following elements:
- (1) training in an FSTD, which includes line oriented flight training (LOFT) and/or flight training;
 - (2) the operator proficiency check, operating as commander;
 - (3) command responsibilities training;
 - (4) line training as commander under supervision, for a minimum of:
 - (i) 10 flight sectors, in the case of aeroplanes; and
 - (ii) 10 hours, including at least 10 flight sectors, in the case of helicopters;
 - (5) completion of a line check as commander and demonstration of adequate knowledge of the route or area to be flown and of the aerodromes, including alternate aerodromes, facilities and procedures to be used; and
 - (6) crew resource management training.

AMC1 ORO.FC.205 Command course

COMBINED UPGRADING AND CONVERSION COURSE — HELICOPTER

If a pilot is converting from one helicopter type or variant to another when upgrading to commander:

- (a) the command course should also include a conversion course in accordance with ORO.FC.220; and
- (b) additional flight sectors should be required for a pilot transitioning onto a new type of helicopter.

ORO.FC.215 Initial operator's crew resource management (CRM) training

- (a) The flight crew member shall have completed an initial CRM training course before commencing unsupervised line flying.
- (b) Initial CRM training shall be conducted by at least one suitably qualified CRM trainer who may be assisted by experts in order to address specific areas.
- (c) If the flight crew member has not previously received theoretical training in human factors to the ATPL level, he/she shall complete, before or combined with the initial CRM training, a theoretical course provided by the operator and based on the human performance and limitations syllabus for the ATPL as established in Annex I (Part-FCL) to Regulation (EU) No 1178/2011.

AMC1 ORO.FC.215 Initial operator's crew resource management (CRM) training

TRAINING ELEMENTS AND TRAINER QUALIFICATION

Initial operator's CRM training should:

- (a) cover the applicable provisions of AMC1 ORO.FC.115, including the training elements as specified in Table 1 thereof; and
- (b) be conducted by a flight crew CRM trainer who is qualified as specified in AMC3 ORO.FC.115.

ORO.FC.220 Operator conversion training and checking

- (a) CRM training shall be integrated into the operator conversion training course.
- (b) Once an operator conversion course has been commenced, the flight crew member shall not be assigned to flying duties on another type or class of aircraft until the course is completed or terminated. Crew members operating only performance class B aeroplanes may be assigned to flights on other types of performance class B aeroplanes during conversion courses to the extent necessary to maintain the operation.
- (c) The amount of training required by the flight crew member for the operator's conversion course shall be determined in accordance with the standards of qualification and experience specified in the operations manual, taking into account his/her previous training and experience.
- (d) The flight crew member shall complete:
 - (1) the operator proficiency check and the emergency and safety equipment training and checking before commencing line flying under supervision (LIFUS); and
 - (2) the line check upon completion of line flying under supervision. For performance class B aeroplanes, LIFUS may be performed on any aeroplane within the applicable class.
- (e) In the case of aeroplanes, pilots that have been issued a type rating based on a zero flight-time training ('ZFTT') course shall:
 - (1) commence line flying under supervision not later than 21 days after the completion of the skill test or after appropriate training provided by the operator. The content of that training shall be described in the operations manual;
 - (2) complete six take-offs and landings in an FSTD not later than 21 days after the completion of the skill test under the supervision of a type rating instructor for aeroplanes ('TRI(A)') occupying the other pilot seat. The number of take-offs and landings may be reduced when credits are defined in the mandatory part of the operational suitability data established in accordance with Regulation (EU) No 748/2012. If those take-offs and landings have not been performed within 21 days, the operator shall provide refresher training the content of which shall be described in the operations manual;
 - (3) conduct the first four take-offs and landings of the LIFUS in the aeroplane under the supervision of a TRI(A) occupying the other pilot seat. The number of take-offs and landings may be reduced when credits are defined in the mandatory part of the operational suitability data established in accordance with Regulation (EU) No 748/2012.

AMC1 ORO.FC.220 Operator conversion training and checking

OPERATOR CONVERSION TRAINING SYLLABUS

- (a) General
 - (1) The operator conversion training should include, in the following order:
 - (i) ground training and checking, including aircraft systems, and normal, abnormal and emergency procedures;
 - (ii) emergency and safety equipment training and checking, (completed before any flight training in an aircraft commences);
 - (iii) flight training and checking (aircraft and/or FSTD); and
 - (iv) line flying under supervision and line check.

-
- (2) When the flight crew member has not previously completed an operator's conversion course, he/she should undergo general first-aid training and, if applicable, ditching procedures training using the equipment in water.
 - (3) Where the emergency drills require action by the non-handling pilot, the check should additionally cover knowledge of these drills.
 - (4) The operator's conversion may be combined with a new type/class rating training, as required by Commission Regulation (EU) No 1178/2011.
 - (5) The operator should ensure that:
 - (i) applicable elements of CRM training, as specified in Table 1 of AMC1 ORO.FC.115, are integrated into all appropriate phases of the conversion training; and
 - (ii) the personnel integrating elements of CRM into conversion training are suitably qualified, as specified in AMC3 ORO.FC.115.
- (b) Ground training
- (1) Ground training should comprise a properly organised programme of ground instruction supervised by training staff with adequate facilities, including any necessary audio, mechanical and visual aids. Self-study using appropriate electronic learning aids, computer-based training (CBT), etc., may be used with adequate supervision of the standards achieved. However, if the aircraft concerned is relatively simple, unsupervised private study may be adequate if the operator provides suitable manuals and/or study notes.
 - (2) The course of ground instruction should incorporate formal tests on such matters as aircraft systems, performance and flight planning, where applicable.
- (c) Emergency and safety equipment training and checking
- (1) Emergency and safety equipment training should take place in conjunction with cabin/technical crew undergoing similar training with emphasis on coordinated procedures and two-way communication between the flight crew compartment and the cabin.
 - (2) On the initial conversion course and on subsequent conversion courses as applicable, the following should be addressed:
 - (i) Instruction on first-aid in general (initial conversion course only); instruction on first-aid as relevant to the aircraft type of operation and crew complement, including those situations where no cabin crew is required to be carried (initial and subsequent).
 - (ii) Aero-medical topics, including:
 - (A) hypoxia;
 - (B) hyperventilation;
 - (C) contamination of the skin/eyes by aviation fuel or hydraulic or other fluids;
 - (D) hygiene and food poisoning; and
 - (E) malaria.
 - (iii) The effect of smoke in an enclosed area and actual use of all relevant equipment in a simulated smoke-filled environment.

- (iv) Actual fire fighting, using equipment representative of that carried in the aircraft on an actual or simulated fire except that, with Halon extinguishers, an alternative extinguisher may be used.
 - (v) The operational procedures of security, rescue and emergency services.
 - (vi) Survival information appropriate to their areas of operation (e.g. polar, desert, jungle or sea) and training in the use of any survival equipment required to be carried.
 - (vii) A comprehensive drill to cover all ditching procedures where flotation equipment is carried. This should include practice of the actual donning and inflation of a life-jacket, together with a demonstration or audio-visual presentation of the inflation of life-rafts and/or slide-rafts and associated equipment. This practice should, on an initial conversion course, be conducted using the equipment in water, although previous certified training with another operator or the use of similar equipment will be accepted in lieu of further wet-drill training.
 - (viii) Instruction on the location of emergency and safety equipment, correct use of all appropriate drills, and procedures that could be required of flight crew in different emergency situations. Evacuation of the aircraft (or a representative training device) by use of a slide where fitted should be included when the operations manual procedure requires the early evacuation of flight crew to assist on the ground.
- (d) Flight training
- (1) Flight training should be conducted to familiarise the flight crew member thoroughly with all aspects of limitations and normal, abnormal and emergency procedures associated with the aircraft and should be carried out by suitably qualified class and type rating instructors and/or examiners. For specific operations, such as steep approaches, ETOPS, or operations based on QFE, additional training should be carried out, based on any additional elements of training defined for the aircraft type in the operational suitability data in accordance with Commission Regulation (EU) No 748/2012, where they exist.
 - (2) In planning flight training on aircraft with a flight crew of two or more, particular emphasis should be placed on the practice of LOFT with emphasis on CRM, and the use of crew coordination procedures, including coping with incapacitation.
 - (3) Normally, the same training and practice in the flying of the aircraft should be given to co-pilots as well as commanders. The 'flight handling' sections of the syllabus for commanders and co-pilots alike should include all the requirements of the operator proficiency check required by ORO.FC.230.
 - (4) Unless the type rating training programme has been carried out in an FSTD usable for ZFTT, the training should include at least three take-offs and landings in the aircraft.
- (e) Line flying under supervision (LIFUS)
- (1) Following completion of flight training and checking as part of the operator's conversion course, each flight crew member should operate a minimum number of sectors and/or flight hours under the supervision of a flight crew member nominated by the operator.
 - (2) The minimum flight sectors/hours should be specified in the operations manual and should be determined by the following:
 - (i) previous experience of the flight crew member;
 - (ii) complexity of the aircraft; and

- (iii) the type and area of operation.
- (3) For performance class B aeroplanes, the amount of LIFUS required is dependent on the complexity of the operations to be performed.
- (f) Passenger handling for operations where no cabin crew is required
Other than general training on dealing with people, emphasis should be placed on the following:
- (1) advice on the recognition and management of passengers who appear or are intoxicated with alcohol, under the influence of drugs or aggressive;
 - (2) methods used to motivate passengers and the crowd control necessary to expedite an aircraft evacuation; and
 - (3) the importance of correct seat allocation with reference to aircraft mass and balance. Particular emphasis should also be given on the seating of special categories of passengers.
- (g) Discipline and responsibilities, for operations where no cabin crew is required
Emphasis should be placed on discipline and an individual's responsibilities in relation to:
- (1) his/her ongoing competence and fitness to operate as a crew member with special regard to flight and duty time limitation (FTL) requirements; and
 - (2) security procedures.
- (h) Passenger briefing/safety demonstrations, for operations where no cabin crew is required
Training should be given in the preparation of passengers for normal and emergency situations.

AMC1 ORO.FC.220&230 Operator conversion training and checking & recurrent training and checking

UPSET PREVENTION AND RECOVERY TRAINING (UPRT) FOR COMPLEX MOTOR-POWERED AEROPLANES WITH A MAXIMUM OPERATIONAL PASSENGER SEATING CONFIGURATION (MOPSC) OF MORE THAN 19

- (a) Upset prevention training should:
- (1) consist of ground training and flight training in an FSTD or an aeroplane;
 - (2) include upset prevention elements from Table 1 for the conversion training course; and
 - (3) include upset prevention elements in Table 1 for the recurrent training programme at least every 12 calendar months, such that all the elements are covered over a period not exceeding 3 years.

Table 1: Elements and respective components of upset prevention training

Elements and components		Ground training	FSTD/ Aeroplane training
A.	Aerodynamics		
1.	General aerodynamic characteristics	•	
2.	Aeroplane certification and limitations	•	
3.	Aerodynamics (high and low altitudes)	•	•
4.	Aeroplane performance (high and low altitudes)	•	•
5.	Angle of attack (AOA) and stall awareness	•	•

6.	Stick shaker or other stall-warning device activation (as applicable)	•	•
7.	Stick pusher (as applicable)	•	•
8.	Mach effects (if applicable to the aeroplane type)	•	•
9.	Aeroplane stability	•	•
10.	Control surface fundamentals	•	•
11.	Use of trims	•	•
12.	Icing and contamination effects	•	•
13.	Propeller slipstream (as applicable)	•	•
B.	Causes of and contributing factors to upsets		
1.	Environmental	•	•
2.	Pilot-induced	•	•
3.	Mechanical (aeroplane systems)	•	•
C.	Safety review of accidents and incidents relating to aeroplane upsets		
1.	Safety review of accidents and incidents relating to aeroplane upsets	•	•
D.	g-load awareness and management		
1.	Positive/negative/increasing/decreasing g-loads	•	•
2.	Lateral g awareness (sideslip)	•	•
3.	g-load management	•	•
E.	Energy management		
1.	Kinetic energy vs potential energy vs chemical energy (power)	•	•
F.	Flight path management		
1.	Relationship between pitch, power and performance	•	•
2.	Performance and effects of differing power plants (if applicable)	•	•
3.	Manual and automation inputs for guidance and control	•	•
4.	Type-specific characteristics	•	•
5.	Management of go-arounds from various stages during the approach	•	•
6.	Automation management	•	•
7.	Proper use of rudder	•	•
G.	Recognition		
1.	Type-specific examples of physiological, visual and instrument clues during developing and developed upsets	•	•
2.	Pitch/power/roll/yaw	•	•
3.	Effective scanning (effective monitoring)	•	•
4.	Type-specific stall protection systems and cues	•	•
5.	Criteria for identifying stalls and upsets	•	•
H.	System malfunction (including immediate handling and subsequent operational considerations, as applicable)		
1.	Flight control defects	•	•
2.	Engine failure (partial or full)	•	•
3.	Instrument failures	•	•
4.	Loss of reliable airspeed	•	•
5.	Automation failures	•	•
6.	Fly-by-wire protection degradations	•	•

7.	Stall protection system failures including icing alerting systems	•	•
I.	Manual handling skills (no autopilot, no autothrust/autothrottle and, where possible, without flight directors)		
1.	Flight at different speeds, including slow flight, and altitudes within the full normal flight envelope		•
2.	Procedural instrument flying and manoeuvring including instrument departure and arrival		•
3.	Visual approach		•
4.	Go-arounds from various stages during the approach		•
5.	Steep turns		•

(b) Upset recovery training should:

- (1) consist of ground training and flight training in an FFS qualified for the training task;
- (2) be completed from each seat in which a pilot's duties require him/her to operate; and
- (3) include the recovery exercises in Table 2 for the recurrent training programme, such that all the exercises are covered over a period not exceeding 3 years.

Table 2: Exercises for upset recovery training

Exercises		Ground training	FFS training
A.	Recovery from developed upsets		
1.	Timely and appropriate intervention	•	•
2.	Recovery from stall events, in the following configurations; <ul style="list-style-type: none"> — take-off configuration, — clean configuration low altitude, — clean configuration near maximum operating altitude, and — landing configuration during the approach phase. 	•	•
3.	Recovery from nose high at various bank angles	•	•
4.	Recovery from nose low at various bank angles	•	•
5.	Consolidated summary of aeroplane recovery techniques	•	•

(c) The operator should ensure that personnel providing FSTD UPRT are competent and current to deliver the training, and understand the capabilities and limitations of the device used.

(d) The FFS qualification requirements in (b)(1) are further clarified in the Guidance Material (GM).

AMC2 ORO.FC.220 Operator conversion training and checking

OPERATOR CONVERSION TRAINING SYLLABUS — FLIGHT ENGINEERS

- (a) Operator conversion training for flight engineers should approximate to that of pilots.
- (b) If the flight crew includes a pilot with the duties of a flight engineer, he/she should, after training and the initial check in these duties, operate a minimum number of flight sectors under the supervision of a nominated additional flight crew member. The minimum figures should be specified in the operations manual and should be selected after due note has been taken of the complexity of the aircraft and the experience of the flight crew member.

AMC2 ORO.FC.220&230 Operator conversion training and checking & recurrent training and checking

UPSET PREVENTION AND RECOVERY TRAINING (UPRT) FOR COMPLEX MOTOR-POWERED AEROPLANES WITH A MAXIMUM OPERATIONAL PASSENGER SEATING CONFIGURATION (MOPSC) OF 19 OR LESS

- (a) Upset prevention training should:
- (1) consist of ground training and flight training in an FSTD or an aeroplane;
 - (2) include upset prevention elements in Table 1 of AMC1 ORO.FC.220&230 for the conversion training course; and
 - (3) include upset prevention elements in Table 1 of AMC1 ORO.FC.220&230 for the recurrent training programme at least every 12 calendar months, such that all the elements are covered over a period not exceeding 3 years.
- (b) Upset recovery training should:
- (1) consist of ground training and flight training in an FFS qualified for the training task, if available;
 - (2) be completed from each seat in which a pilot's duties require him/her to operate; and
 - (3) include the recovery exercises in Table 2 of AMC1 ORO.FC.220&230 for the recurrent training programme, such that all the exercises are covered over a period not exceeding 3 years.
- (c) The operator should ensure that personnel providing FSTD UPRT are competent and current to deliver the training, and understand the capabilities and limitations of the device used.
- (d) The FFS qualification requirements in (b)(1) are further specified in the Guidance Material (GM).

GM1 ORO.FC.220(c) Operator conversion training and checking

OPERATOR CONVERSION COURSE (OCC) FOR MULTI-CREW PILOT LICENCE (MPL) HOLDERS

When defining the amount of training for MPL holders, who undertake their first conversion course on a new type or at an operator other than the one that was involved in their training for the MPL, the operator should put a process in place to ensure that corrective action can be taken if post-MPL licence training evaluation indicates the need to do so.

GM1 ORO.FC.220&230 Operator conversion training and checking & recurrent training and checking

UPSET PREVENTION AND RECOVERY TRAINING (UPRT) FOR COMPLEX MOTOR-POWERED AEROPLANES

The objective of the UPRT is to help flight crew acquire the required competencies in order to prevent or recover from a developing or developed aeroplane upset. Prevention training prepares flight crew to avoid incidents whereas recovery training prepares flight crew to prevent an accident once an upset condition has developed.

HUMAN FACTORS

Threat and Error Management (TEM) and Crew Resource Management (CRM) principles should be integrated into the UPRT. In particular, the surprise and startle effect, and the importance of resilience development should be emphasised.

Training should also emphasise that an actual upset condition may expose flight crew to significant physiological and psychological challenges, such as visual illusions, spatial disorientation and unusual g-forces, with the objective to develop strategies to deal with such challenges.

USE OF FSTD FOR UPRT

The use of an FSTD provides valuable training without the risks associated with aeroplane training. In order to avoid ‘negative transfer of training’, the capabilities of the specific FSTD to be used should be considered when designing and delivering the training programme, especially when manoeuvre training could involve operation outside the normal flight envelope of the aeroplane, for example during aerodynamic stall. Type specific content contained in the training programme should be developed in consultation with the Original Equipment Manufacturers (OEMs).

Some FSTDs may offer capabilities that could enhance the UPRT, such as Instructor Operating Station (IOS) features. Operators may consider the value of such features in support of their training objectives.

ADDITIONAL GUIDANCE

Specific guidance to the UPRT elements and exercises contained in the AMC is available from the latest revision of the ICAO Document 10011 (‘Manual on UPRT’).

Further guidance is available from revision 2 of the aeroplane upset recovery training aid (AURTA), the UK CAA Paper 2013/02 (‘Monitoring Matters’), and the Flight Safety Foundation Publication (‘A Practical Guide for Improving Flight Path Monitoring’), November 2014.

GM2 ORO.FC.220&230 Operator conversion training and checking & recurrent training and checking

UPSET PREVENTION TRAINING FOR COMPLEX MOTOR-POWERED AEROPLANES

The recurrent training should prioritise the upset prevention elements and respective components according to the operator’s safety risk assessment.

Upset prevention training should use a combination of manoeuvre-based and scenario-based training. Scenario-based training may be used to introduce flight crew to situations which, if not correctly managed, could lead to an upset condition. Relevant TEM and CRM aspects should be included in scenario-based training and the flight crew should understand the limitations of the FSTD in replicating the physiological and psychological aspects of exposure to upset prevention scenarios.

In order to avoid negative training and negative transfer of training, operators should ensure that the selected upset prevention scenarios and exercises take into consideration the limitations of the FSTD and the extent to which it represents the handling characteristics of the actual aeroplane. If it is determined that the FSTD is not suitable, the operator should ensure that the required training outcome can be achieved by other means.

GO-AROUNDS FROM VARIOUS STAGES DURING THE APPROACH

Operators should conduct the go-around exercises from various altitudes during the approach with all engines operating, taking into account the following considerations:

- Un-planned go-arounds expose the crew to the surprise and startle effect;
- Go-arounds with various aeroplane configurations and different weights; and
- Balked landings (between Decision Altitude and touchdown or after touchdown unless thrust reversers have been activated).

In addition to full thrust all engine go-arounds, operators should consider including exercises using the ‘limited thrust’ go-around procedure, when available. This procedure reduces the risk of the airframe structural limits being exceeded and reduces the risk of crew being exposed to somatogravic illusion and disorientation effects, thereby reducing the risk of aeroplane upsets further.

The go-around exercises should always be performed in accordance with the OEM procedures and recommendations.

GM3 ORO.FC.220&230 Operator conversion training and checking & Recurrent training and checking

UPSET RECOVERY TRAINING FOR COMPLEX MOTOR-POWERED AEROPLANES

The upset recovery training exercises should be manoeuvre-based, which enables flight crew to apply their handling skills and recovery strategy whilst leveraging CRM principles to return the aeroplane from an upset condition to a stabilised flight path.

The flight crew should understand the limitations of the FFS in replicating the physiological and psychological aspects of upset recovery exercises.

In order to avoid negative training and negative transfer of training, operators should ensure that the selected upset recovery exercises take into consideration the limitations of the FFS.

STALL EVENT RECOVERY TRAINING

It is of utmost importance that stall event recovery training takes into account the capabilities of the FFS used. Most current and grandfathered FFS models are deficient in representing the aeroplane in the aerodynamic stall regime, thus practising of ‘full stall’ in such a device could potentially result in negative training or negative transfer of training. The term ‘stall event’ is therefore introduced to cater for the capability of current and grandfathered FFS, and for potential future FFS enhancements. A ‘stall event’ is defined as an occurrence whereby the aeroplane experiences one or more conditions associated with an approach-to-stall or an aerodynamic stall.

IMPORTANT – when using current or grandfathered FFS, the stall event recovery exercises should only be conducted as approach-to-stall exercises.

Stall event recovery training should emphasise the requirement to reduce the angle of attack (AOA) whilst accepting the resulting altitude loss. High-altitude stall event training should be included so that flight crew appreciate the aeroplane control response, the significant altitude loss during the recovery, and the increased time required. The training should also emphasise the risk of triggering a secondary stall event during the recovery.

Recovery from a stall event should always be in accordance with the stall event recovery procedures of the OEMs. If an OEM-approved recovery procedure does not exist, operators should develop and train the aeroplane-specific stall recovery procedure based on the template in Table 1 below.

Refer to revision 2 of the AURTA for a detailed explanation and rationale on the stall event recovery template as recommended by the OEMs.

Table 1: Recommended Stall Event Recovery Template

Stall Event Recovery Template
Pilot Flying - Immediately do the following at first indication of a stall (aerodynamic buffeting, reduced roll stability and aileron effectiveness, visual or aural cues and warnings, reduced elevator

(pitch) authority, inability to maintain altitude or arrest rate of descent, stick shaker activation (if installed).) – during any flight phases <i>except at lift-off</i> .	
Pilot Flying (PF)	Pilot Monitoring (PM)
1. AUTOPILOT – DISCONNECT (A large out-of-trim condition could be encountered when the autopilot is disconnected.)	MONITOR airspeed and attitude throughout the recovery and ANNOUNCE any continued divergence
2. AUTOTHRUST/AUTOTHROTTLE – OFF	
3. a) NOSE DOWN PITCH CONTROL apply until stall warning is eliminated b) NOSE DOWN PITCH TRIM (as needed) (Reduce the angle of attack (AOA) whilst accepting the resulting altitude loss.)	
4. BANK – WINGS LEVEL	
5. THRUST – ADJUST (as needed) (Thrust reduction for aeroplanes with underwing mounted engines may be needed)	
6. SPEEDBRAKES/SPOILERS - RETRACT	
7. When airspeed is sufficiently increasing - RECOVER to level flight (Avoid the secondary stall due premature recovery or excessive g-loading.)	

NOSE HIGH AND NOSE LOW RECOVERY TRAINING

Nose-high and nose-low recovery training should be in accordance with the strategies recommended by the OEMs contained in the Tables 2 and 3 below. As the OEM procedures always take precedence over the recommendations, operators should consult their OEM on whether any approved type-specific recovery procedures are available prior to using the templates.

Refer to revision 2 of the AURTA for a detailed explanation and rationale on the nose high and nose low recovery strategies as recommended by the OEMs.

Table 2: Recommended Nose High Recovery Strategy Template

Nose HIGH Recovery Strategy	
Either pilot - Recognise and confirm the developing situation by announcing: ‘Nose High’	
PF	PM
1. AUTOPILOT – DISCONNECT (A large out of trim condition could be encountered when the AP is disconnected.)	MONITOR airspeed and attitude throughout the recovery and ANNOUNCE any continued divergence
2. AUTOTHRUST/AUTOTHROTTLE – OFF	
3. APPLY as much nose-down control input as required to obtain a nose-down pitch rate	

4.	THRUST – ADJUST (if required) (Thrust reduction for aeroplanes with underwing mounted engines may be needed.)	
5.	ROLL – ADJUST (if required) (Avoid exceeding 60 degrees bank.)	
6.	When airspeed is sufficiently increasing - RECOVER to level flight (Avoid the secondary stall due premature recovery or excessive g-loading.)	
NOTE:		
<ol style="list-style-type: none"> 1) Recovery to level flight may require use of pitch trim. 2) If necessary, consider reducing thrust in aeroplanes with underwing-mounted engines to aid in achieving nose-down pitch rate. 3) WARNING: Excessive use of pitch trim or rudder may aggravate the upset situation or may result in high structural loads. 		

Table 3: Recommended Nose Low Recovery Strategy Template

Nose LOW Recovery Strategy Template		
<p>Either pilot - Recognise and confirm the developing situation by announcing: ‘Nose Low’ (If the autopilot or autothrust/autothrottle is responding correctly, it may not be appropriate to decrease the level of automation while assessing if the divergence is being stopped.)</p>		
PF		PM
1.	AUTOPILOT – DISCONNECT (A large out of trim condition could be encountered when the AP is disconnected.)	MONITOR airspeed and attitude throughout the recovery and ANNOUNCE any continued divergence
2.	AUTOTHRUST/AUTOTHROTTLE – OFF	
3.	RECOVERY from stall if required	
4.	ROLL in the shortest direction to wings level. (It may be necessary to reduce the g-loading by applying forward control pressure to improve roll effectiveness)	
5.	THRUST and DRAG – ADJUST (if required)	
6.	RECOVER to level flight. (Avoid the secondary stall due premature recovery or excessive g-loading.)	
NOTE:		
<ol style="list-style-type: none"> 1) Recovery to level flight may require use of pitch trim. 2) WARNING: Excessive use of pitch trim or rudder may aggravate the upset situation or may result in high structural loads. 		

GM4 ORO.FC.220&230 Operator conversion training and checking & recurrent training and checking**FFS QUALIFIED FOR THE UPSET RECOVERY TRAINING TASK**

The FFS used for the upset recovery training should be qualified to ensure the training task objectives can be achieved and negative transfer of training is avoided.

A level C or D FFS is qualified for the upset recovery training task, such as the approach-to-stall exercises. Full aerodynamic stall or other exercises outside the validated training envelope (VTE) should not be conducted.

A level B FFS may become qualified for the upset recovery training task if equivalency to at least level C for the specific features needed for the task can be demonstrated in accordance with CS-FSTD(A) Appendix 8 to AMC1 FSTD(A).300 General Technical Requirements for FSTD Qualification Levels, and associated FSTD validation tests.

FSTD operators may achieve such demonstration of equivalency through the conduct of a special evaluation by the competent authority. Once the level B FFS is deemed to be qualified, the competent authority should enter the additional capability on the certificate using the wording 'upset recovery training'. FSTD Operators are reminded that the individual FFS used must be approved for the training by the competent authority in accordance with ORO.FC.145(c).

Equivalency to at least level C for the specific features needed for the training task may be demonstrated using the following guidance and list in Table 1 of minimum objective and subjective functional test.

General

- Refer to Subpart C Aeroplane Flight Simulation Training Devices AMC1 FSTD(A).300(c)(1)(i) and (2)(ii) for the scope of the qualification criteria;
- A six-degrees-of-freedom motion system should be provided; and
- The response to control inputs should not be greater than 150 ms more than that experienced on the aeroplane (see Appendix 1 to CS-FSTD(A).300 General r.1).

Table 1: Minimum FSTD standards, validation tests, and functions and subjective tests

FSTD Standards
Appendix 1 to CS-FSTD(A).300 Flight Simulation Training Device Standards (Ref. CS-FSTD(A) pages 9 - 22)
1. General - q.1, r.1, s.1, t.1, w.1
2. Motion System - b.1(3)
3. Visual System - b.2
FSTD Validation Tests
AMC1 FSTD(A).300 Qualification Basis – Table of FSTD Validation Tests (Ref. CS-FSTD(A) pages 46 - 75)
1. Performance - <i>Climb</i> - c.(4)
2. Handling Qualities - <i>Dynamic Control Checks</i> - b.(1), b.(2), b.(3), b.(4), b.(5), b.(6)

3. Motion System - e.
4. Visual System - a.(1) or a.(2), b.(1)(a)
Functions and Subjective Tests
AMC1 FSTD(A).300 Qualification Basis – Functions and Subjective Tests (CS-FSTD(A) page 115)
p. Special Effects - <i>Effects of Airframe and Engine Icing</i> - (2)(a) (See Appendix 1 to CS FSTD(A).300 1.t.1.)

GM5 ORO.FC.220&230 Operator conversion training and checking & recurrent training and checking

PERSONNEL PROVIDING FSTD UPSET PREVENTION AND RECOVERY TRAINING (UPRT)

It is of paramount importance that personnel providing UPRT in FSTDs have the specific competence to deliver such training, which may not have been demonstrated during previous instructor qualification training. Operators should, therefore, have a comprehensive training and standardisation programme in place, and may need to provide FSTD instructors with additional training to ensure such instructors have and maintain complete knowledge and understanding of the UPRT operating environment, and skill sets.

Standardisation and training should ensure that personnel providing FSTD UPRT:

- (1) are able to demonstrate the correct upset recovery techniques for the specific aeroplane type;
- (2) understand the importance of applying type-specific Original Equipment Manufacturers (OEMs) procedures for recovery manoeuvres;
- (3) are able to distinguish between the applicable SOPs and the OEMs recommendations (if available);
- (4) understand the capabilities and limitations of the FSTD used for UPRT;
- (5) are aware of the potential of negative transfer of training that may exist when training outside the capabilities of the FSTD;
- (6) understand and are able to use the IOS of the FSTD in the context of effective UPRT delivery;
- (7) understand and are able to use the FSTD instructor tools available for providing accurate feedback on flight crew performance;
- (8) understand the importance of adhering to the FSTD UPRT scenarios that have been validated by the training programme developer; and
- (9) understand the missing critical human factor aspects due to the limitations of the FSTD and convey this to the flight crew receiving the training.

GM1 ORO.FC.220(b) Operator conversion training and checking

COMPLETION OF AN OPERATOR'S CONVERSION COURSE

- (a) The operator conversion course is deemed to have started when the flight training has begun. The theoretical element of the course may be undertaken ahead of the practical element.

- (b) Under certain circumstances the course may have started and reached a stage where, for unforeseen reasons, it is not possible to complete it without a delay. In these circumstances, the operator may allow the pilot to revert to the original type.
- (c) Before the resumption of the operator conversion course, the operator should evaluate how much of the course needs to be repeated before continuing with the remainder of the course.

GM1 ORO.FC.220(d) Operator conversion training and checking

LINE FLYING UNDER SUPERVISION

- (a) Line flying under supervision provides the opportunity for a flight crew member to carry into practice the procedures and techniques he/she has been made familiar with during the ground and flight training of an operator conversion course. This is accomplished under the supervision of a flight crew member specifically nominated and trained for the task. At the end of line flying under supervision the respective crew member should be able to perform a safe and efficient flight conducted within the tasks of his/her crew member station.
- (b) A variety of reasonable combinations may exist with respect to:
 - (1) a flight crew member's previous experience;
 - (2) the complexity of the aircraft concerned; and
 - (3) the type of route/role/area operations.
- (c) Aeroplanes

The following minimum figures for details to be flown under supervision are guidelines for operators to use when establishing their individual requirements:

- (1) turbo-jet aircraft
 - (i) co-pilot undertaking first operator conversion course:
 - (A) total accumulated 100 hours or minimum 40 flight sectors;
 - (ii) co-pilot upgrading to commander:
 - (A) minimum 20 flight sectors when converting to a new type;
 - (B) minimum 10 flight sectors when already qualified on the aeroplane type.

ORO.FC.230 Recurrent training and checking

- (a) Each flight crew member shall complete recurrent training and checking relevant to the type or variant of aircraft on which they operate.
- (b) *Operator proficiency check*
- (1) Each flight crew member shall complete operator proficiency checks as part of the normal crew complement to demonstrate competence in carrying out normal, abnormal and emergency procedures.
 - (2) When the flight crew member will be required to operate under IFR, the operator proficiency check shall be conducted without external visual reference, as appropriate.
 - (3) The validity period of the operator proficiency check shall be six calendar months. For operations under VFR by day of performance class B aeroplanes conducted during seasons not longer than eight consecutive months, one operator proficiency check shall be sufficient. The proficiency check shall be undertaken before commencing commercial air transport operations.
 - (4) The flight crew member involved in operations by day and over routes navigated by reference to visual landmarks with an other-than complex motor-powered helicopter may complete the operator proficiency check in only one of the relevant types held. The operator proficiency check shall be performed each time on the type least recently used for the proficiency check. The relevant helicopter types that may be grouped for the purpose of the operator proficiency check shall be contained in the operations manual.
 - (5) Notwithstanding ORO.FC.145(a)(2), for operations of other-than complex motor-powered helicopters by day and over routes navigated by reference to visual landmarks and performance class B aeroplanes, the check may be conducted by a suitably qualified commander nominated by the operator, trained in CRM concepts and the assessment of CRM skills. The operator shall inform the competent authority about the persons nominated.
- (c) *Line check*
- (1) Each flight crew member shall complete a line check on the aircraft to demonstrate competence in carrying out normal line operations described in the operations manual. The validity period of the line check shall be 12 calendar months.
 - (2) Notwithstanding ORO.FC.145(a)(2), line checks may be conducted by a suitably qualified commander nominated by the operator, trained in CRM concepts and the assessment of CRM skills.
- (d) *Emergency and safety equipment training and checking*
- Each flight crew member shall complete training and checking on the location and use of all emergency and safety equipment carried. The validity period of an emergency and safety equipment check shall be 12 calendar months.
- (e) *CRM training*
- (1) Elements of CRM shall be integrated into all appropriate phases of the recurrent training.
 - (2) Each flight crew member shall undergo specific modular CRM training. All major topics of CRM training shall be covered by distributing modular training sessions as evenly as possible over each three-year period.
- (f) Each flight crew member shall undergo ground training and flight training in an FSTD or an aircraft, or a combination of FSTD and aircraft training, at least every 12 calendar months.

- (g) The validity periods mentioned in (b)(3), (c) and (d) shall be counted from the end of the month when the check was taken.
- (h) When the training or checks required above are undertaken within the last three months of the validity period, the new validity period shall be counted from the original expiry date.

AMC1 ORO.FC.230 Recurrent training and checking

RECURRENT TRAINING SYLLABUS

(a) Recurrent training

Recurrent training should comprise the following:

(1) Ground training

(i) The ground training programme should include:

- (A) aircraft systems;
- (B) operational procedures and requirements, including ground de-icing/anti-icing and pilot incapacitation; and
- (C) accident/incident and occurrence review.

(ii) Knowledge of the ground training should be verified by a questionnaire or other suitable methods.

(iii) When the ground training is conducted within 3 calendar months prior to the expiry of the 12 calendar months period, the next ground and refresher training should be completed within 12 calendar months of the original expiry date of the previous training.

(2) Emergency and safety equipment training

(i) Emergency and safety equipment training may be combined with emergency and safety equipment checking and should be conducted in an aircraft or a suitable alternative training device.

(ii) Every year the emergency and safety equipment training programme should include the following:

- (A) actual donning of a life-jacket, where fitted;
- (B) actual donning of protective breathing equipment, where fitted;
- (C) actual handling of fire extinguishers of the type used;
- (D) instruction on the location and use of all emergency and safety equipment carried on the aircraft;
- (E) instruction on the location and use of all types of exits;
- (F) security procedures.

(iii) Every 3 years the programme of training should include the following:

- (A) actual operation of all types of exits;
- (B) demonstration of the method used to operate a slide where fitted;
- (C) actual fire-fighting using equipment representative of that carried in the aircraft on an actual or simulated fire except that, with Halon extinguishers, an alternative extinguisher may be used;

- (D) the effects of smoke in an enclosed area and actual use of all relevant equipment in a simulated smoke-filled environment;
- (E) actual handling of pyrotechnics, real or simulated, where applicable;
- (F) demonstration in the use of the life-rafts where fitted. In the case of helicopters involved in extended over water operations, demonstration and use of the life-rafts.

Helicopter water survival training

Where life-rafts are fitted for helicopter extended overwater operations (such as sea pilot transfer, offshore operations, regular, or scheduled, coast-to-coast overwater operations), a comprehensive wet drill to cover all ditching procedures should be practised by aircraft crew. This wet drill should include, as appropriate, practice of the actual donning and inflation of a life-jacket, together with a demonstration or audio-visual presentation of the inflation of life-rafts. Crews should board the same (or similar) life-rafts from the water whilst wearing a life-jacket. Training should include the use of all survival equipment carried on board life-rafts and any additional survival equipment carried separately on board the aircraft;

- consideration should be given to the provision of further specialist training such as underwater escape training. Where operations are predominately conducted offshore, operators should conduct 3-yearly helicopter underwater escape training at an appropriate facility;
 - wet practice drill should always be given in initial training unless the crew member concerned has received similar training provided by another operator;
- (G) particularly in the case where no cabin crew is required, first-aid, appropriate to the aircraft type, the kind of operation and crew complement.
- (iv) The successful resolution of aircraft emergencies requires interaction between flight crew and cabin/technical crew and emphasis should be placed on the importance of effective coordination and two-way communication between all crew members in various emergency situations.
 - (v) Emergency and safety equipment training should include joint practice in aircraft evacuations so that all who are involved are aware of the duties other crew members should perform. When such practice is not possible, combined flight crew and cabin/technical crew training should include joint discussion of emergency scenarios.
 - (vi) Emergency and safety equipment training should, as far as practicable, take place in conjunction with cabin/technical crew undergoing similar training with emphasis on coordinated procedures and two-way communication between the flight crew compartment and the cabin.

(3) CRM

Elements of CRM training, as specified in Table 1 of AMC1 ORO.FC.115, should be integrated into all appropriate phases of recurrent training.

(4) Aircraft/FSTD training

(i) General

-
- (A) The aircraft/FSTD training programme should be established in a way that all major failures of aircraft systems and associated procedures will have been covered in the preceding 3 year period.
 - (B) When engine-out manoeuvres are carried out in an aircraft, the engine failure should be simulated.
 - (C) Aircraft/FSTD training may be combined with the operator proficiency check.
 - (D) When the aircraft/FSTD training is conducted within 3 calendar months prior to the expiry of the 12 calendar months period, the next aircraft/FSTD training should be completed within 12 calendar months of the original expiry date of the previous training.
- (ii) Helicopters
- (A) Where a suitable FSTD is available, it should be used for the aircraft/FSTD training programme. If the operator is able to demonstrate, on the basis of a compliance and risk assessment, that using an aircraft for this training provides equivalent standards of training with safety levels similar to those achieved using an FSTD, the aircraft may be used for this training to the extent necessary.
 - (B) The recurrent training should include the following additional items, which should be completed in an FSTD:
 - settling with power and vortex ring;
 - loss of tail rotor effectiveness.
- (5) For operations with other-than-complex motor-powered aeroplanes, all training and checking should be relevant to the type of operation and class of aeroplane on which the flight crew member operates with due account taken of any specialised equipment used.
- (b) Recurrent checking
- Recurrent checking should comprise the following:
- (1) Operator proficiency checks
- (i) Aeroplanes
- Where applicable, operator proficiency checks should include the following manoeuvres as pilot flying:
- (A) rejected take-off when an FSTD is available to represent that specific aeroplane, otherwise touch drills only;
 - (B) take-off with engine failure between V_1 and V_2 (take-off safety speed) or, if carried out in an aeroplane, at a safe speed above V_2 ;
 - (C) 3D approach operation to minima with, in the case of multi-engine aeroplanes, one-engine-inoperative;
 - (D) 2D approach operation to minima;
 - (E) at least one of the 3D or 2D approach operations should be an RNP APCH or RNP AR APCH operation;
 - (F) missed approach on instruments from minima with, in the case of multi-engined aeroplanes, one-engine-inoperative;

(G) landing with one-engine-inoperative. For single-engine aeroplanes a practice forced landing is required.

(ii) Helicopters

(A) Where applicable, operator proficiency checks should include the following abnormal/emergency procedures:

- engine fire;
- fuselage fire;
- emergency operation of under carriage;
- fuel dumping;
- engine failure and relight;
- hydraulic failure;
- electrical failure;
- engine failure during take-off before decision point;
- engine failure during take-off after decision point;
- engine failure during landing before decision point;
- engine failure during landing after decision point;
- flight and engine control system malfunctions;
- recovery from unusual attitudes;
- landing with one or more engine(s) inoperative;
- instrument meteorological conditions (IMC) autorotation techniques;
- autorotation to a designated area;
- pilot incapacitation;
- directional control failures and malfunctions.

(B) For pilots required to engage in IFR operations, proficiency checks include the following additional abnormal/emergency procedures:

- 3D approach operation to minima;
- go-around on instruments from minima with, in the case of multi-engined helicopters, a simulated failure of one engine;
- 2D approach operation to minima;
- at least one of the 3D or 2D approach operations should be an RNP APCH or RNP AR APCH operation;
- in the case of multi-engined helicopters, a simulated failure of one engine to be included in either the 3D or 2D approach operation to minima;
- landing with a simulated failure of one or more engines;
- where appropriate to the helicopter type, approach with flight control system/flight director system malfunctions, flight instrument and navigation equipment failures.

- (C) Before a flight crew member without a valid instrument rating is allowed to operate in VMC at night, he/she should be required to undergo a proficiency check at night. Thereafter, each second proficiency check should be conducted at night.
 - (iii) Once every 12 months the checks prescribed in (b)(1)(ii)(A) may be combined with the proficiency check for revalidation or renewal of the aircraft type rating.
 - (iv) Operator proficiency checks should be conducted by a type rating examiner (TRE) or a synthetic flight examiner (SFE), as applicable.
- (2) Emergency and safety equipment checks
- The items to be checked should be those for which training has been carried out in accordance with (a)(2).
- (3) Line checks
- (i) Line checks should establish the ability to perform satisfactorily a complete line operation, including pre-flight and post-flight procedures and use of the equipment provided, as specified in the operations manual. The route chosen should be such as to give adequate representation of the scope of a pilot's normal operations. When weather conditions preclude a manual landing, an automatic landing is acceptable. The commander, or any pilot who may be required to relieve the commander, should also demonstrate his/her ability to 'manage' the operation and take appropriate command decisions.
 - (ii) The flight crew should be assessed on their CRM skills in accordance with the methodology described in AMC1 ORO.FC.115 and as specified in the operations manual.
 - (iii) CRM assessment should not be used as a reason for a failure of the line check, unless the observed behaviour could lead to an unacceptable reduction in safety margin.
 - (iv) When pilots are assigned duties as pilot flying and pilot monitoring, they should be checked in both functions.
 - (v) Line checks should be conducted by a commander nominated by the operator. The operator should inform the competent authority about the persons nominated. The person conducting the line check should occupy an observer's seat where installed. His/her CRM assessments should solely be based on observations made during the initial briefing, cabin briefing, flight crew compartment briefing and those phases where he/she occupies the observer's seat.
 - (A) For aeroplanes, in the case of long haul operations where additional operating flight crew are carried, the person may fulfil the function of a cruise relief pilot and should not occupy either pilot's seat during take-off, departure, initial cruise, descent, approach and landing.
 - (vi) Where a pilot is required to operate as pilot flying and pilot monitoring, he/she should be checked on one flight sector as pilot flying and on another flight sector as pilot monitoring. However, where the operator's procedures require integrated flight preparation, integrated cockpit initialisation and that each pilot performs both flying and monitoring duties on the same sector, then the line check may be performed on a single flight sector.

- (4) When the operator proficiency check, line check or emergency and safety equipment check are undertaken within the final 3 calendar months of validity of a previous check, the period of validity of the subsequent check should be counted from the expiry date of the previous check.
 - (5) In the case of single-pilot operations with helicopters, the recurrent checks referred to in (b)(1), (2) and (3) should be performed in the single-pilot role on a particular helicopter type in an environment representative of the operation.
- (c) Flight crew incapacitation training, except single-pilot operations
- (1) Procedures should be established to train flight crew to recognise and handle flight crew incapacitation. This training should be conducted every year and can form part of other recurrent training. It should take the form of classroom instruction, discussion, audio-visual presentation or other similar means.
 - (2) If an FSTD is available for the type of aircraft operated, practical training on flight crew incapacitation should be carried out at intervals not exceeding 3 years.
- (d) Personnel providing training and checking
- Training and checking should be provided by the following personnel:
- (1) ground and refresher training by suitably qualified personnel;
 - (2) flight training by a flight instructor (FI), type rating instructor (TRI) or class rating instructor (CRI) or, in the case of the FSTD content, a synthetic flight instructor (SFI), providing that the FI, TRI, CRI or SFI satisfies the operator's experience and knowledge requirements sufficient to instruct on the items specified in paragraphs (a)(1)(i)(A) and (B);
 - (3) emergency and safety equipment training by suitably qualified personnel;
 - (4) CRM:
 - (i) integration of CRM elements into all the phases of the recurrent training by all the personnel conducting recurrent training. The operator should ensure that all personnel conducting recurrent training are suitably qualified to integrate elements of CRM into this training;
 - (ii) classroom CRM training by at least one CRM trainer, qualified as specified in AMC3 ORO.FC.115 who may be assisted by experts in order to address specific areas.
 - (5) recurrent checking by the following personnel:
 - (i) operator proficiency check by a type rating examiner (TRE), class rating examiner (CRE) or, if the check is conducted in an FSTD, a TRE, CRE or a synthetic flight examiner (SFE), trained in CRM concepts and the assessment of CRM skills.
 - (ii) emergency and safety equipment checking by suitably qualified personnel.
- (e) Use of FSTD
- (1) Training and checking provide an opportunity to practice abnormal/emergency procedures that rarely arise in normal operations and should be part of a structured programme of recurrent training. This should be carried out in an FSTD whenever possible.
 - (2) The line check should be performed in the aircraft. All other training and checking should be performed in an FSTD, or, if it is not reasonably practicable to gain access to such devices, in an aircraft of the same type or in the case of emergency and safety equipment training, in a representative training device. The type of equipment used for training and

checking should be representative of the instrumentation, equipment and layout of the aircraft type operated by the flight crew member.

- (3) Because of the unacceptable risk when simulating emergencies such as engine failure, icing problems, certain types of engine(s) (e.g. during continued take-off or go-around, total hydraulic failure), or because of environmental considerations associated with some emergencies (e.g. fuel dumping) these emergencies should preferably be covered in an FSTD. If no FSTD is available, these emergencies may be covered in the aircraft using a safe airborne simulation, bearing in mind the effect of any subsequent failure, and the exercise must be preceded by a comprehensive briefing.

AMC2 ORO.FC.230 Recurrent training and checking

FLIGHT ENGINEERS

- (a) The recurrent training and checking for flight engineers should meet the requirements for pilots and any additional specific duties, omitting those items that do not apply to flight engineers.
- (b) Recurrent training and checking for flight engineers should, whenever possible, take place concurrently with a pilot undergoing recurrent training and checking.
- (c) The line check should be conducted by a commander or by a flight engineer nominated by the operator, in accordance with national rules, if applicable.

GM1 ORO.FC.230 Recurrent training and checking

LINE CHECK AND PROFICIENCY TRAINING AND CHECKING

- (a) Line checks, route and aerodrome knowledge and recent experience requirements are intended to ensure the crew member's ability to operate efficiently under normal conditions, whereas other checks and emergency and safety equipment training are primarily intended to prepare the crew member for abnormal/emergency procedures.
- (b) The line check is considered a particularly important factor in the development, maintenance and refinement of high operating standards, and can provide the operator with a valuable indication of the usefulness of his/her training policy and methods. Line checks are a test of a flight crew member's ability to perform a complete line operation, including pre-flight and post-flight procedures and use of the equipment provided, and an opportunity for an overall assessment of his/her ability to perform the duties required as specified in the operations manual. The line check is not intended to determine knowledge on any particular route.
- (c) Proficiency training and checking
When an FSTD is used, the opportunity should be taken, where possible, to use LOFT.

GM1 ORO.FC.230(a);(b);(f) Recurrent training and checking

EVIDENCE-BASED RECURRENT TRAINING AND CHECKING OF FLIGHT CREW CONDUCTED IN FLIGHT SIMULATION TRAINING DEVICES (FSTDs)

ICAO developed Doc 9995 'Manual of Evidence-based Training', which is intended to provide guidance to civil aviation authorities, operators and approved training organisations in the recurrent assessment and training of pilots by establishing a new methodology for the development and conduct of a recurrent training and assessment programme, titled evidence-based training (EBT).

‘Evidence-based training (EBT)’ means training and assessment based on operational data that is characterised by developing and assessing the overall capability of a trainee across a range of core competencies rather than by measuring the performance during individual events or manoeuvres.

ICAO Doc 9995 is the reference document for operators seeking to implement EBT. The purpose of this guidance material (GM) is to enable the implementation of EBT according to the principles established in ICAO Doc 9995 taking into account the European regulatory framework.

In the current regulatory framework it is possible to achieve a mixed implementation of EBT. Implementation of a mixed EBT programme means that some portion of the recurrent assessment and training is dedicated to the application of EBT. This includes the Licence Proficiency Check (LPC) and the Operator Proficiency Check (OPC).

As it is possible to combine LPC and OPC in ORO.FC, this GM is applicable to both checks. Therefore, the EBT training programme described in this GM refers to the recurrent training and checking of flight crew, including LPCs and OPCs.

The EBT training programme takes into account the differences between aircraft of different generations and the effect of these differences on training. The operator should acquire a thorough knowledge of ICAO Doc 9995 before implementing this GM. For applicability, see ICAO Doc 9995 Chapter 3.

EBT programme

Within the current regulatory framework the operator may undertake a mixed implementation of the baseline EBT programme according to this GM. The baseline EBT programme is defined in ICAO Doc 9995 Chapter 4.3.1 and in Appendices 2 to 7.

The baseline EBT programme provides the flexibility to adapt programmes according to specific operator risks. Elements of the enhanced EBT programme may be implemented according to the definition and process described in ICAO Doc 9995 Chapter 5.

The operator should contact the competent authority in order for them to assess the application of the process described in ICAO Doc 9995 including, where applicable, the results from data analyses to support the enhanced EBT programme.

Personnel providing training and checking in EBT (Refers to AMC1 ORO.FC.230(d))

ICAO Doc 9995 Chapter 6, which is additional to EU regulations, contains the guidance for the training and assessment of personnel involved in the conduct of EBT.

Equivalency of malfunctions/Malfunction clustering (Refers to ICAO Doc 9995 Paragraph 3.8.3)

According to the concept of ICAO Doc 9995 Chapter 3.8.3, major failures reduce the capability of the aircraft or the ability of the crew to cope with operating conditions to the extent that there would be a significant reduction in functional capabilities, significant increase in crew workload or in conditions impairing crew efficiency.

Clusters of major failures of aircraft systems are determined by reference to malfunction characteristics and the underlying elements of crew performance required to manage them. Malfunction clustering may be used to guide the operator towards the implementation of an EBT programme according to AMC1 ORO.FC.230(a)(4)(i)(A) and ORO.FC.145(d).

Conduct of Licence and Operator Proficiency Checks

The EBT programme described in ICAO Doc 9995 contains modules with three phases: the evaluation phase, the manoeuvres training phase, and the scenario-based training phase. In order to comply with the existing regulatory framework, LPC and OPC requirements are fulfilled by a combination of the evaluation phase and the manoeuvres validation phase, which replaces the manoeuvres training phase

described in ICAO Doc 9995. The manoeuvres validation phase is defined in Section 3 below. This is a form of mixed implementation, which is described as follows:

1. Evaluation phase: This includes check scenarios referred to in Part-FCL Appendix 9 within an accepted EBT programme.

In order to facilitate the provision of simple and realistic scenarios in accordance with ICAO Doc 9995 Chapters 3.8 and 7.4, the evaluation phase is not intended to be a comprehensive assessment of all Part-FCL Appendix 9 items; nevertheless, the list below includes the items that should be included in the evaluation phase only.

Part-FCL or Part-ORO reference	Description
Part-FCL Appendix 9 Paragraph 6	The examiner may choose between different skill test or proficiency check scenarios containing simulated relevant operations developed and approved by the competent authority. Full-flight simulators and other training devices, when available, shall be used, as established in this Part.
Part-FCL Appendix 9 Paragraph 16	The test/check should be accomplished under instrument flight rules (IFRs), if instrument rating (IR) is included, and as far as possible be accomplished in a simulated commercial air transport environment. An essential element to be checked is the ability to plan and conduct the flight from routine briefing material.
Part-FCL Appendix 9 Item 1.4	Use of checklist prior to starting engines, starting procedures, radio and navigation equipment check, selection and setting of navigation and communication frequencies.
Part-FCL Appendix 9 Item 1.6	Before take-off checks.
Part-FCL Appendix 9 Item 3.9.1*	Adherence to departure and arrival routes and ATC instructions. The starred item (*) shall be flown solely by reference to instruments. If this condition is not met during the skill test or proficiency check, the type rating will be restricted to VFR only.

2. Manoeuvres validation phase: The purpose of the manoeuvres validation phase is to check the handling skills necessary to fly critical flight manoeuvres so that they are maintained to a defined level of proficiency. This replaces the manoeuvres training phase described in ICAO Doc 9995 Chapter 7.5. Manoeuvres in this context are not part of line-oriented flight scenario; they are a sequence of deliberate actions to achieve a prescribed flight path or to perform a prescribed event to a prescribed outcome. All remaining items listed in Part-FCL Appendix 9, and not included in the evaluation phase, should be included here.

3. Scenario-based training phase: The purpose of the scenario-based training phase is to further develop pilot core competencies in a learning environment. This does not form part of any LPC or OPC requirement.

It should be noted that if the operator is following an alternative means of compliance to ORO.FC.230(b) Operator Proficiency Check, the equivalence of using EBT evaluation and manoeuvres validation phases may no longer exist.

ORO.FC.235 Pilot qualification to operate in either pilot's seat

- (a) Commanders whose duties require them to operate in either pilot seat and carry out the duties of a co-pilot, or commanders required to conduct training or checking duties, shall complete additional training and checking as specified in the operations manual. The check may be conducted together with the operator proficiency check prescribed in ORO.FC.230(b).
- (b) The additional training and checking shall include at least the following:
 - (1) an engine failure during take-off;
 - (2) a one-engine-inoperative approach and go-around; and
 - (3) a one-engine-inoperative landing.
- (c) In the case of helicopters, commanders shall also complete their proficiency checks from left- and right-hand seats, on alternate proficiency checks, provided that when the type rating proficiency check is combined with the operator proficiency check the commander completes his/her training or checking from the normally occupied seat.
- (d) When engine-out manoeuvres are carried out in an aircraft, the engine failure shall be simulated.
- (e) When operating in the co-pilot's seat, the checks required by ORO.FC.230 for operating in the commander's seat shall, in addition, be valid and current.
- (f) The pilot relieving the commander shall have demonstrated, concurrent with the operator proficiency checks prescribed in ORO.FC.230(b), practice of drills and procedures that would not, normally, be his/her responsibility. Where the differences between left- and right-hand seats are not significant, practice may be conducted in either seat.
- (g) The pilot other than the commander occupying the commander's seat shall demonstrate practice of drills and procedures, concurrent with the operator proficiency checks prescribed in ORO.FC.230(b), which are the commander's responsibility acting as pilot monitoring. Where the differences between left- and right-hand seats are not significant, practice may be conducted in either seat.

AMC1 ORO.FC.235(d) Pilot qualification to operate in either pilot's seat

SINGLE-ENGINE HELICOPTERS — AUTOROTATIVE LANDING

In the case of single-engined helicopters, the autorotative landing should be carried out from left- and right-hand seats on alternate proficiency checks.

GM1 ORO.FC.235(f);(g) Pilot qualification to operate in either pilot's seat

DIFFERENCES BETWEEN LEFT AND RIGHT-HAND SEATS

The differences between left- and right-hand seats may not be significant in cases where, for example, the autopilot is used.

ORO.FC.240 Operation on more than one type or variant

- (a) The procedures or operational restrictions for operation on more than one type or variant established in the operations manual and approved by the competent authority shall cover:
- (1) the flight crew members' minimum experience level;
 - (2) the minimum experience level on one type or variant before beginning training for and operation of another type or variant;
 - (3) the process whereby flight crew qualified on one type or variant will be trained and qualified on another type or variant; and
 - (4) all applicable recent experience requirements for each type or variant.
- (b) When a flight crew member operates both helicopters and aeroplanes, that flight crew member shall be limited to operations on only one type of aeroplane and one type of helicopter.
- (c) Point (a) shall not apply to operations of performance class B aeroplane if they are limited to single-pilot classes of reciprocating engine aeroplanes under VFR by day. Point (b) shall not apply to operations of performance class B aeroplane if they are limited to single-pilot classes of reciprocating engine aeroplanes.

AMC1 ORO.FC.240 Operation on more than one type or variant

GENERAL

- (a) Aeroplanes
- (1) When a flight crew member operates more than one aeroplane class, type or variant, as determined by the operational suitability data established in accordance with Commission Regulation (EU) No 748/2012 for class-single pilot or type-single pilot, but not within a single licence endorsement, the operator should ensure that the flight crew member does not operate more than:
 - (i) three reciprocating engine aeroplane types or variants;
 - (ii) three turbo-propeller aeroplane types or variants;
 - (iii) one turbo-propeller aeroplane type or variant and one reciprocating engine aeroplane type or variant; or
 - (iv) one turbo-propeller aeroplane type or variant and any aeroplane within a particular class.
 - (2) When a flight crew member operates more than one aeroplane type or variant within one or more licence endorsement, as determined by the operational suitability data established in accordance with Commission Regulation (EU) No 748/2012, the operator should ensure that:
 - (i) the minimum flight crew complement specified in the operations manual is the same for each type or variant to be operated;
 - (ii) the flight crew member does not operate more than two aeroplane types or variants for which a separate licence endorsement is required, unless credits related to the training, checking, and recent experience requirements are defined in operational suitability data established in accordance with Commission Regulation (EU) No 748/2012 for the relevant types or variants; and

- (iii) only aeroplanes within one licence endorsement are flown in any one flight duty period, unless the operator has established procedures to ensure adequate time for preparation.
- (3) When a flight crew member operates more than one aeroplane type or variant as determined by the operational suitability data established in accordance with Commission Regulation (EU) No 748/2012 for type-single pilot and type-multi pilot, but not within a single licence endorsement, the operator should comply with points (a)(2) and (4).
- (4) When a flight crew member operates more than one aeroplane type or variant as determined by the operational suitability data established in accordance with Commission Regulation (EU) No 748/2012 for type multi-pilot, but not within a single licence endorsement, or combinations of aeroplane types or variants as determined by the operational suitability data established in accordance with Commission Regulation (EU) No 748/2012 for class single-pilot and type multi-pilot, the operator should comply with the following:
- (i) point (a)(2);
 - (ii) before exercising the privileges of more than one licence endorsement:
 - (A) flight crew members should have completed two consecutive operator proficiency checks and should have:
 - 500 hours in the relevant crew position in CAT operations with the same operator; or
 - for IFR and VFR night operations with performance class B aeroplanes, 100 hours or flight sectors in the relevant crew position in CAT operations with the same operator, if at least one licence endorsement is related to a class. A check flight should be completed before the pilot is released for duties as commander;
 - (B) in the case of a pilot having experience with an operator and exercising the privileges of more than one licence endorsement, and then being promoted to command with the same operator on one of those types, the required minimum experience as commander is 6 months and 300 hours, and the pilot should have completed two consecutive operator proficiency checks before again being eligible to exercise more than one licence endorsement;
 - (iii) before commencing training for and operation of another type or variant, flight crew members should have completed 3 months and 150 hours flying on the base aeroplane, which should include at least one proficiency check, unless credits related to the training, checking and recent experience requirements are defined in operational suitability data established in accordance with Commission Regulation (EU) No 748/2012 for the relevant types or variants;
 - (iv) after completion of the initial line check on the new type, 50 hours flying or 20 sectors should be achieved solely on aeroplanes of the new type rating, unless credits related to the training, checking and recent experience requirements are defined in operational suitability data established in accordance with Commission Regulation (EU) No 748/2012 for the relevant types or variants;
 - (v) recent experience requirements established in Commission Regulation (EU) No 1178/2011 for each type operated;

- (vi) the period within which line flying experience is required on each type should be specified in the operations manual;
 - (vii) when credits are defined in operational suitability data established in accordance with Commission Regulation (EU) No 748/2012 for the relevant type or variant, this should be reflected in the training required in ORO.FC.230 and:
 - (A) ORO.FC.230 (b) requires two operator proficiency checks every year. When credits are defined in operational suitability data established in accordance with Commission Regulation (EU) No 748/2012 for operator proficiency checks to alternate between the types, each operator proficiency check should revalidate the operator proficiency check for the other type(s). The operator proficiency check may be combined with the proficiency checks for revalidation or renewal of the aeroplane type rating or the instrument rating in accordance with Commission Regulation (EU) No 1178/2011.
 - (B) ORO.FC.230 (c) requires one line check every year. When credits are defined in operational suitability data established in accordance with Commission Regulation (EU) No 748/2012 for line checks to alternate between types or variants, each line check should revalidate the line check for the other type or variant.
 - (C) Annual emergency and safety equipment training and checking should cover all requirements for each type.
- (b) Helicopters
- (1) If a flight crew member operates more than one type or variant, the following provisions should be met:
 - (i) The recency requirements and the requirements for recurrent training and checking should be met and confirmed prior to CAT operations on any type, and the minimum number of flights on each type within a 3-month period specified in the operations manual.
 - (ii) ORO.FC.230 requirements with regard to recurrent training.
 - (iii) When credits related to the training, checking and recent experience requirements are defined in operational suitability data established in accordance with Commission Regulation (EU) No 748/2012 for the relevant types or variants, the requirements of ORO.FC.230 with regard to proficiency checks may be met by a 6 monthly check on any one type or variant operated. However, a proficiency check on each type or variant operated should be completed every 12 months.
 - (iv) For helicopters with a maximum certified take-off mass (MCTOM) of more than 5 700 kg, or with a maximum operational passenger seating configuration (MOPSC) of more than 19:
 - (A) the flight crew member should not fly more than two helicopter types, unless credits related to the training, checking and recent experience requirements are defined in operational suitability data established in accordance with Commission Regulation (EU) No 748/2012 for the relevant types or variants;
 - (B) a minimum of 3 months and 150 hours experience on the type or variant should be achieved before the flight crew member should commence the conversion course onto the new type or variant, unless credits related to the training, checking and recent experience requirements are defined in

- operational suitability data established in accordance with Commission Regulation (EU) No 748/2012 for the relevant types or variants;
- (C) 28 days and/or 50 hours flying should then be achieved exclusively on the new type or variant, unless credits related to the training, checking and recent experience requirements are defined in operational suitability data established in accordance with Commission Regulation (EU) No 748/2012 for the relevant types or variants; and
 - (D) a flight crew member should not be rostered to fly more than one type or significantly different variant of a type during a single duty period.
 - (v) In the case of all other helicopters, the flight crew member should not operate more than three helicopter types or significantly different variants, unless credits related to the training, checking and recent experience requirements are defined in operational suitability data established in accordance with Commission Regulation (EU) No 748/2012 for the relevant types or variants.
- (c) Combination of helicopter and aeroplane
- (1) The flight crew member may fly one helicopter type or variant and one aeroplane type irrespective of their MCTOM or MOPSC.
 - (2) If the helicopter type is covered by paragraph (b)(1)(iv) then (b)(1)(iv)(B), (C) and (D) should also apply in this case.

AMC2 ORO.FC.240 Operation on more than one type or variant

GENERAL

(a) Terminology

The terms used in the context of the operation of more than one type or variant have the following meaning:

- (1) Base aircraft means an aircraft used as a reference to compare differences with another aircraft.
- (2) Variant means an aircraft or a group of aircraft within the same pilot type rating that has differences to the base aircraft requiring difference training or familiarisation training.
- (3) Credit means the recognition of training, checking or recent experience based on commonalities between aircraft. For substantiation of the credits ODR tables or other appropriate documentation for comparison of the relevant aircraft characteristics may be provided.
- (4) Operator difference requirements (ODRs) mean a formal description of differences between types or variants flown by a particular operator.

(b) Philosophy

The concept of operating more than one type or variant depends upon the experience, knowledge and ability of the operator and the flight crew concerned.

The first consideration is whether or not aircraft types or variants are sufficiently similar to allow the safe operation of both.

The second consideration is whether or not the types or variants are sufficiently similar for the training, checking and recent experience. Unless credits have been established by the operational suitability data in accordance with Commission Regulation (EU) No 748/2012, all

training, checking and recent experience requirements should be completed independently for each type or variant.

(c) Methodology – Use of Operator Difference Requirement (ODR) Tables

(1) Before assigning flight crew members to operate more than one type or variant of aircraft, the operator should conduct a detailed evaluation of the differences or similarities of the aircraft concerned in order to establish appropriate procedures or operational restrictions. This evaluation should be based on the data established in accordance with Commission Regulation (EU) No 748/2012 for the relevant types or variants, and should be adapted to the operator’s specific aircraft configurations. This evaluation should take into account of the following:

- (i) the level of technology;
- (ii) operational procedures; and
- (iii) handling characteristics.

The methodology described below should be used as a means of evaluating aeroplane differences and similarities to justify the operation of more than one type or variant, and when credit is sought.

(2) ODR tables

Before requiring flight crew members to operate more than one type or variant, operators should first nominate one aircraft as the base aircraft from which to show differences with the second aircraft type or variant, the ‘difference aircraft’, in terms of technology (systems), procedures, pilot handling and aircraft management. These differences, known as operator difference requirements (ODR), preferably presented in tabular format, constitute part of the justification for operating more than one type or variant and also the basis for the associated differences/familiarisation or reduced type rating training for the flight crew.

(3) The ODR tables should be presented as follows:

GENERAL OPERATOR DIFFERENCES REQUIREMENTS TABLE										
DIFFERENCE AIRCRAFT: BASE AIRCRAFT:				COMPLIANCE METHOD						
				TRAINING					CHKG/ CURR	
General	Differences	Flt char	Proc chg	A	B	C	D	E	FLT CHK	REC EXP
GENERAL	Range ETOPS Certified	No	Yes		CBT					
DIMENSIONS	Configuration per AFM, FCOM	Yes	No		CBT					

SYSTEM OPERATOR DIFFERENCES REQUIREMENTS TABLE										
DIFFERENCE AIRCRAFT: BASE AIRCRAFT:				COMPLIANCE METHOD						
				TRAINING					CHKG/ CURR	
System	Differences	Flt char	Proc chg	A	B	C	D	E	FLT CHK	REC EXP

21 – AIR CONDITIONING	CONTROLS AND INDICATORS: - Panel layout	No	Yes	HO							
21 – AIR CONDITIONING	PACKS: - Switch type - Automatically controlled - Reset switch for both packs	No	Yes		CBT						

MANOEUVRE OPERATOR DIFFERENCES REQUIREMENTS TABLE											
DIFFERENCE AIRCRAFT: BASE AIRCRAFT:				COMPLIANCE METHOD							
				TRAINING					CHKG/ CURR		
Manoeuvre	Differences	Flt char	Proc chg	A	B	C	D	E	FLT CHK	REC EXP	
Exterior Preflight	Minor differences	NO	NO	HO							
Preflight	Differences due to systems, ECL	NO	YES		CBT	FTD					
Normal takeoff	FBW handling vs Conventional; AFDS TAKEOFF: - Autothrottle engagement FMA indications	NO	YES		CBT			FFS			

(4) Compilation of ODR Tables

(i) ODR 1: General

The general characteristics of the candidate aircraft are compared with the base aircraft with regard to:

- (A) general dimensions and aircraft design (number and type of rotors, wing span or category);
- (B) flight deck general design;
- (C) cabin layout;
- (D) engines (number, type and position);
- (E) limitations (flight envelope).

(ii) ODR 2: Systems

Consideration is given to differences in design between the candidate aircraft and the base aircraft. For this comparison the Air Transport Association (ATA) 100 index is used. This index establishes a system and subsystem classification and then an analysis performed for each index item with respect to the main architectural, functional and operations elements, including controls and indications on the systems control panel.

(iii) ODR 3: Manoeuvres

Operational differences encompass normal, abnormal and emergency situations and include any change in aircraft handling and flight management. It is necessary to establish a list of operational items for consideration on which an analysis of differences can be made.

The operational analysis should take the following into account:

- (A) flight deck dimensions (size, cut-off angle and pilot eye height);
- (B) differences in controls (design, shape, location and function);
- (C) additional or altered function (flight controls) in normal or abnormal conditions;
- (D) handling qualities (including inertia) in normal and in abnormal configurations;
- (E) aircraft performance in specific manoeuvres;
- (F) aircraft status following failure;
- (G) management (e.g. ECAM, EICAS, navaid selection, automatic checklists).

(iv) Once the differences for ODR 1, ODR 2 and ODR 3 have been established, the consequences of differences evaluated in terms of flight characteristics (FLT CHAR) and change of procedures (PROC CHNG) should be entered into the appropriate columns.

(v) Difference Levels – crew training, checking and currency

- (A) The final stage of an operator's proposal to operate more than one type or variant is to establish crew training, checking and currency requirements. This may be established by applying the coded difference levels from Table 4 to the compliance method column of the ODR Tables.
- (B) Differences items identified in the ODR tables as impacting flight characteristics, or procedures, should be analysed in the corresponding ATA section of the ODR manoeuvres. Normal, abnormal and emergency situations should be addressed accordingly.

(d) Difference Levels

(1) Difference levels — General

Difference levels are used to identify the extent of difference between a base and a candidate aircraft with reference to the elements described in the ODR tables. These levels are proportionate to the differences between a base and a candidate aircraft. A range of five difference levels in order of increasing requirements, identified as A through E, are each specified for training, checking, and currency.

Difference levels apply when a difference with the potential to affect flight safety exists between a base and a candidate aircraft. Differences may also affect the knowledge, skills, or abilities required from a pilot. If no differences exist, or if differences exist but do not affect flight safety, or if differences exist but do not affect knowledge, skills, or abilities, then difference levels are neither assigned nor applicable to pilot qualification. When difference levels apply, each level is based on a scale of differences related to design features, systems, or manoeuvres. In assessing the effects of differences, both flight characteristics and procedures are considered since flight characteristics address handling qualities and performance, while procedures include normal, non-normal and emergency items.

Levels for training, checking, and currency are assigned independently, but are linked depending on the differences between a base and candidate aircraft. Training at level E usually identifies that the candidate aircraft is a different type to the base aircraft.

- (2) Difference levels are summarised in the table below regarding training, checking, and currency.

DIFFERENCE LEVEL	TRAINING	CHECKING	CURRENCY
A	<ul style="list-style-type: none"> Self-instruction 	Not applicable or integrated with next proficiency check	Not applicable
B	<ul style="list-style-type: none"> Aided instruction 	Task or system check	Self-review
C	<ul style="list-style-type: none"> System devices 	Partial proficiency check using qualified device	Designated system
D	Manoeuvre Training Devices ¹ or aircraft to accomplish specific manoeuvres	Partial proficiency check using qualified device ¹	Designated manoeuvre(s) ¹
E	FSTDs ² or aircraft	Proficiency check using FSTDs ² or aircraft	As per regulation, using FSTDs ² or aircraft

Footnote (1):

- *Aeroplane: FTD Level 2, or FFS, or aeroplane*
- *Helicopter: FTD Level 2 and 3, or FFS, or helicopter*

Footnote (2):

- *Aeroplane: FFS Level C or D, or aeroplane*
- *Helicopter: FSTD'S having dual qualification: FFS Level B and FTD Level 3, or FFS Level C or D, or helicopter*

Training Levels A and B require familiarisation training, levels C and D require differences training. Training Level E means that differences are such that type rating training is required.

- (3) Difference level — Training

The training differences levels specified represent the minimum requirements. Devices associated with a higher difference level may be used to satisfy a training differences requirement.

- (i) Level A training

Level A differences training is applicable to aircraft with differences that can adequately be addressed through self-instruction. Level A training represents a knowledge requirement such that once appropriate information is provided, understanding and compliance can be assumed to be demonstrated.

Training needs not covered by level A training may require level B training, or higher, depending on the outcome of the evaluations described in the aircraft evaluation process (CS FCD.420).

(ii) Level B training

Level B differences training is applicable to aircraft with system or procedure differences that can adequately be addressed through aided instruction.

At level B aided instruction it is appropriate to ensure pilot understanding, emphasise issues, provide a standardised method of presentation of material, or to aid retention of material following training.

(iii) Level C training

Level C differences training can only be accomplished through the use of devices capable of systems training.

Level C differences training is applicable to variants having 'part task' differences that affect skills or abilities as well as knowledge. Training objectives focus on mastering individual systems, procedures, or tasks, as opposed to performing highly integrated flight operations and manoeuvres in 'real time'. Level C may also require self-instruction or aided instruction of a pilot, but cannot be adequately addressed by a knowledge requirement alone. Training devices are required to supplement instruction to ensure attainment or retention of pilot skills and abilities to accomplish the more complex tasks, usually related to operation of particular aircraft systems.

The minimum acceptable training media for level C is interactive computer-based training, cockpit systems simulators, cockpit procedure trainers, part task trainers [such as Inertial Navigation System (INS), Flight Management System (FMS), or Traffic Collision Avoidance System (TCAS) trainers], or similar devices.

(iv) Level D training

Level D differences training can only be accomplished with devices capable of performing flight manoeuvres and addressing full task differences affecting knowledge, skills, or abilities.

Devices capable of flight manoeuvres address full task performance in a dynamic 'real time' environment and enable integration of knowledge, skills and abilities in a simulated flight environment, involving combinations of operationally oriented tasks and realistic task loading for each relevant phase of flight. At level D, knowledge and skills to complete necessary normal, non-normal and emergency procedures are fully addressed for each variant.

Level D differences training requires mastery of interrelated skills that cannot be adequately addressed by separate acquisition of a series of knowledge areas or skills that are interrelated. However, the differences are not so significant, that a full type rating training course is required. If demonstration of interrelationships between the systems was important, the use of a series of separate devices for systems training would not suffice. Training for level D differences requires a training device that has accurate, high fidelity integration of systems and controls and realistic instrument indications. Level D training may also require manoeuvre visual cues, motion cues, dynamics, control loading or specific environmental conditions. Weather phenomena such as low visibility operations or wind shear may or may not be incorporated. Where simplified or generic characteristics of an aircraft type are used in devices to satisfy level D difference training, significant negative training cannot occur as a result of the simplification.

Appropriate devices as described in CS FCD.420(a), satisfying level D differences training range from those where relevant elements of aircraft flight manoeuvring, performance, and handling qualities are incorporated. The use of a Manoeuvre Training Device or aircraft is limited for the conduct of specific manoeuvres or handling differences, or for specific equipment or procedures.

(v) Level E training

Level E differences training is applicable to candidate aircraft having such a significant ‘full task’ differences that a full type rating training course or a type rating training course with credit for previous experience on similar aircraft types is required to meet the training objectives.

The training requires a ‘high fidelity’ environment to attain or maintain knowledge, skills, or abilities that can only be satisfied by the use of FSTDs or the aircraft itself as mentioned in CS FCD.415(a). Level E training, if done in an aircraft, should be modified for safety reasons where manoeuvres can result in a high degree of risk.

When level E differences training is assigned, suitable credit or constraints may be applied for knowledge, skills or abilities related to other pertinent aircraft types and specifies the relevant subjects, procedures or manoeuvres.

(4) Difference level — Checking

Differences checking addresses any pertinent pilot testing or checking. Initial and recurrent checking levels are the same unless otherwise specified.

It may be possible to satisfactorily accomplish recurrent checking objectives in devices not meeting initial checking requirements. In such instances the applicant may propose for revalidation checks the use of certain devices not meeting the initial check requirements.

(i) Level A checking

Level A differences checking indicates that no check related to differences is required at the time of differences training. However, a pilot is responsible for knowledge of each variant flown.

(ii) Level B checking

Level B differences checking indicates that a ‘task’ or ‘systems’ check is required following initial and recurring training.

(iii) Level C checking

Level C differences checking requires a partial check using a suitable qualified device. A partial check is conducted relative to particular manoeuvres or systems.

(iv) Level D checking

Level D differences checking indicates that a partial proficiency check is required following both initial and recurrent training. In conducting the partial proficiency check, manoeuvres common to each variant may be credited and need not be repeated. The partial proficiency check covers the specified particular manoeuvres, systems, or devices. Level D checking is performed using scenarios representing a ‘real time’ flight environment and uses qualified devices permitted for level D training or higher.

(v) Level E checking

Level E differences checking requires that a full proficiency check be conducted in FSTDs or in an aircraft as mentioned in CS FCD.415(a), following both initial and recurrent training. If appropriate, alternating Level E checking between relevant aircraft is possible and credit may be defined for procedures or manoeuvres based on commonality.

Assignment of level E checking requirements alone, or in conjunction with level E currency, does not necessarily result in assignment of a separate type rating.

(5) Difference level — Currency

Differences currency addresses any currency and re-currency levels. Initial and recurrent currency levels are the same unless otherwise specified.

(i) Level A currency

Level A currency is common to each aircraft and does not require separate tracking. Maintenance of currency in any aircraft suffices for any other variant within the same type rating.

(ii) Level B currency

Level B currency is 'knowledge-related' currency, typically achieved through self-review by individual pilots.

(iii) Level C currency

(A) Level C currency is applicable to one or more designated systems or procedures, and relates to both skill and knowledge requirements. When level C currency applies, any pertinent lower level currency is also to be addressed.

(B) Re-establishing level C currency

When currency is lost, it may be re-established by completing required items using a device equal to or higher than that specified for level C training and checking.

(iv) Level D currency

(A) Level D currency is related to designated manoeuvres and addresses knowledge and skills required for performing aircraft control tasks in real time with integrated use of associated systems and procedures. Level D currency may also address certain differences in flight characteristics including performance of any required manoeuvres and related normal, non-normal and emergency procedures. When level D is necessary, any pertinent lower level currency is also to be addressed.

(B) Re-establishing level D currency

When currency is lost, currency may be re-established by completing pertinent manoeuvres using a device equal to or higher than that specified for level D differences training and checking.

(v) Level E currency

(A) Level E currency requires that recent experience requirements of Part-FCL and operational requirements be complied with in each aircraft separately. Level E currency may also specify other system, procedure, or manoeuvre currency item(s) necessary for safe operations, and requires procedures or

manoeuvres to be accomplished in FSTDs or in an aircraft as mentioned in CS FCD.415(a). Provisions are applied in a way which addresses the required system or manoeuvre experience.

When level E is assigned between aircraft of common characteristics, credit may be permitted. Assignment of level E currency requirements does not automatically lead to a determination on same or separate type rating. Level E currency is tracked by a means that is acceptable to the competent authority.

When CTLC is permitted, any credit or constraints applicable to using FSTDs, as mentioned in CS FCD.415(a), are also to be determined.

(B) Re-establishing level E currency

When currency is lost, currency may be re-established by completing pertinent manoeuvres using a device specified for level E differences training and checking.

(6) Competency regarding non-normal and emergency procedures — Currency

Competency for non-normal and emergency manoeuvres or procedures is generally addressed by checking requirements. Particular non-normal and emergency manoeuvres or procedures may not be considered mandatory for checking or training. In this situation it may be necessary to periodically practice or demonstrate those manoeuvres or procedures specifying currency requirements for those manoeuvres or procedures.

ORO.FC.A.245 Alternative training and qualification programme

- (a) The aeroplane operator having appropriate experience may substitute one or more of the following training and checking requirements for flight crew by an alternative training and qualification programme (ATQP), approved by the competent authority:
- (1) SPA.LVO.120 on flight crew training and qualifications;
 - (2) conversion training and checking;
 - (3) differences training and familiarisation training;
 - (4) command course;
 - (5) recurrent training and checking; and
 - (6) operation on more than one type or variant.
- (b) The ATQP shall contain training and checking that establishes and maintains at least an equivalent level of proficiency achieved by complying with the provisions of ORO.FC.220 and ORO.FC.230. The level of flight crew training and qualification proficiency shall be demonstrated prior to being granted the ATQP approval by the competent authority.
- (c) The operator applying for an ATQP approval shall provide the competent authority with an implementation plan, including a description of the level of flight crew training and qualification proficiency to be achieved.
- (d) In addition to the checks required by ORO.FC.230 and FCL.060 of Annex I (Part-FCL) to Regulation (EU) No 1178/2011, each flight crew member shall complete a line oriented evaluation (LOE) conducted in an FSTD. The validity period of an LOE shall be 12 calendar months. The validity period shall be counted from the end of the month when the check was taken. When the LOE is undertaken within the last three months of the validity period, the new validity period shall be counted from the original expiry date.
- (e) After two years of operating with an approved ATQP, the operator may, with the approval of the competent authority, extend the validity periods of the checks in ORO.FC.230 as follows:
- (1) Operator proficiency check to 12 calendar months. The validity period shall be counted from the end of the month when the check was taken. When the check is undertaken within the last three months of the validity period, the new validity period shall be counted from the original expiry date.
 - (2) Line check to 24 calendar months. The validity period shall be counted from the end of the month when the check was taken. When the check is undertaken within the last six months of the validity period, the new validity period shall be counted from the original expiry date.
 - (3) Emergency and safety equipment checking to 24 calendar months. The validity period shall be counted from the end of the month when the check was taken. When the check is undertaken within the last six months of the validity period, the new validity period shall be counted from the original expiry date.

AMC1 ORO.FC.A.245 Alternative training and qualification programme**COMPONENTS AND IMPLEMENTATION**

- (a) Alternative training and qualification programme (ATQP) components

The ATQP should comprise the following:

- (1) Documentation that details the scope and requirements of the programme, including the following:
 - (i) The programme should demonstrate that the operator is able to improve the training and qualification standards of flight crew to a level that exceeds the standards prescribed in ORO.FC and Subpart E of Annex V (SPA.LVO).
 - (ii) The operator's training needs and established operational and training objectives.
 - (iii) A description of the process for designing and gaining approval for the operator's flight crew qualification programmes. This should include quantified operational and training objectives identified by the operator's internal monitoring programmes. External sources may also be used.
 - (iv) A description of how the programme will:
 - (A) enhance safety;
 - (B) improve training and qualification standards of flight crew;
 - (C) establish attainable training objectives;
 - (D) integrate CRM in all aspects of training;
 - (E) develop a support and feedback process to form a self-correcting training system;
 - (F) institute a system of progressive evaluations of all training to enable consistent and uniform monitoring of the training undertaken by flight crew;
 - (G) enable the operator to be able to respond to new aeroplane technologies and changes in the operational environment;
 - (H) foster the use of innovative training methods and technology for flight crew instruction and the evaluation of training systems; and
 - (I) make efficient use of training resources, specifically to match the use of training media to the training needs.
- (2) A task analysis to determine:
 - (i) knowledge;
 - (ii) required skills;
 - (iii) associated skill-based training; and
 - (iv) validated behavioural markers, where appropriate.

For each aeroplane type/class to be included within the ATQP the operator should establish a systematic review that determines and defines the various tasks to be undertaken by the flight crew when operating that type/class. Data from other types/classes may also be used. The analysis should determine and describe the knowledge and skills required to complete the various tasks specific to the aeroplane type/class and/or type of operation. In addition, the analysis should identify the appropriate behavioural markers that should be exhibited. The task analysis should be suitably validated in accordance with (b)(3). The task analysis, in conjunction with the data gathering programme(s), permits the operator to establish a programme of targeted training together with the associated training objectives.

- (3) Curricula. The curriculum structure and content should be determined by task analysis, and should include proficiency objectives, including when and how these objectives should be met.
- (i) The training programme should have the following structure:
- (A) Curriculum, specifying the following elements:
- (a) Entry requirements: a list of topics and content, describing what training level will be required before start or continuation of training.
- (b) Topics: a description of what will be trained during the lesson.
- (c) Targets/Objectives
- (1) Specific target or set of targets that have to be reached and fulfilled before the training course can be continued.
- (2) Each specified target should have an associated objective that is identifiable both by the flight crew and the trainers.
- (3) Each qualification event that is required by the programme should specify the training that is required to be undertaken and the required standard to be achieved.
- (B) Daily lesson plan
- (a) Each lesson/course/training or qualification event should have the same basic structure. The topics related to the lesson should be listed and the lesson targets should be unambiguous.
- (b) Each lesson/course or training event whether classroom, CBT or simulator should specify the required topics with the relevant targets to be achieved.
- (4) A specific training programme for:
- (i) each aeroplane type/class within the ATQP;
- (ii) instructors (class rating instructor rating/synthetic flight instructor authorisation/type rating instructor rating — CRI/SFI/TRI), and other personnel undertaking flight crew instruction; and
- (iii) examiners (class rating examiner/synthetic flight examiner/type rating examiner — CRE/SFE/TRE).

This should include a method for the standardisation of instructors and examiners.

Personnel who perform training and checking of flight crew in an operator's ATQP should receive the following additional training on:

- (A) ATQP principles and goals;
- (B) knowledge/skills/behaviour as learnt from task analysis;
- (C) line-oriented evaluation (LOE)/ LOFT scenarios to include triggers/markers/event sets/observable behaviour;
- (D) qualification standards;
- (E) harmonisation of assessment standards;
- (F) behavioural markers and the systemic assessment of CRM;

- (G) event sets and the corresponding desired knowledge/skills and behaviour of the flight crew;
 - (H) the processes that the operator has implemented to validate the training and qualification standards and the instructors part in the ATQP quality control; and
 - (I) line-oriented quality evaluation (LOQE).
- (5) A feedback loop for the purpose of curriculum validation and refinement, and to ascertain that the programme meets its proficiency objectives.
- (i) The feedback should be used as a tool to validate that the curricula are implemented as specified by the ATQP; this enables substantiation of the curriculum, and that proficiency and training objectives have been met. The feedback loop should include data from operations flight data monitoring, the advanced flight data monitoring (FDM) programme and LOE/LOQE programmes. In addition, the evaluation process should describe whether the overall targets/objectives of training are being achieved and should prescribe any corrective action that needs to be undertaken.
 - (ii) The programme's established quality control mechanisms should at least review the following:
 - (A) procedures for approval of recurrent training;
 - (B) ATQP instructor training approvals;
 - (C) approval of event set(s) for LOE/LOFT;
 - (D) procedures for conducting LOE and LOQE.
- (6) A method for the assessment of flight crew during conversion and recurrent training and checking. The assessment process should include event-based assessment as part of the LOE. The assessment method should comply with ORO.FC.230.
- (i) The qualification and checking programmes should include at least the following elements:
 - (A) a specified structure;
 - (B) elements to be tested/examined;
 - (C) targets and/or standards to be attained;
 - (D) the specified technical and procedural knowledge and skills, and behavioural markers to be exhibited.
 - (ii) An LOE event should comprise tasks and sub-tasks performed by the crew under a specified set of conditions. Each event has one or more specific training targets/objectives, which require the performance of a specific manoeuvre, the application of procedures, or the opportunity to practise cognitive, communication or other complex skills. For each event the proficiency that is required to be achieved should be established. Each event should include a range of circumstances under which the crews' performance is to be measured and evaluated. The conditions pertaining to each event should also be established and they may include the prevailing meteorological conditions (ceiling, visibility, wind, turbulence, etc.), the operational environment (navigation aid inoperable, etc.), and the operational contingencies (non-normal operation, etc.).

- (iii) The markers specified under the operator's ATQP should form one of the core elements in determining the required qualification standard. A typical set of markers is shown in the table below:

EVENT	MARKER
Awareness of aeroplane systems:	1. Monitors and reports changes in automation status
	2. Applies closed loop principle in all relevant situations
	3. Uses all channels for updates
	4. Is aware of remaining technical resources

- (iv) The topics/targets integrated into the curriculum should be measurable and progression on any training/course is only allowed if the targets are fulfilled.
- (7) A data monitoring/analysis programme consisting of the following:
- (i) A flight data monitoring (FDM) programme, as described in AMC1 ORO.AOC.130. Data collection should reach a minimum of 60 % of all relevant flights conducted by the operator before ATQP approval is granted. This proportion may be increased as determined by the competent authority.
- (ii) An advanced FDM when an extension to the ATQP is requested: an advanced FDM programme is determined by the level of integration with other safety initiatives implemented by the operator, such as the operator's safety management system. The programme should include both systematic evaluations of data from an FDM programme and flight crew training events for the relevant crews. Data collection should reach a minimum of 80 % of all relevant flights and training conducted by the operator. This proportion may be varied as determined by the competent authority.

The purpose of an FDM or advanced FDM programme for ATQP is to enable the operator to:

- (A) provide data to support the programme's implementation and justify any changes to the ATQP;
- (B) establish operational and training objectives based upon an analysis of the operational environment; and
- (C) monitor the effectiveness of flight crew training and qualification.
- (iii) Data gathering: the data analysis should be made available to the person responsible for ATQP within the organisation. The data gathered should:
- (A) include all fleets that are planned to be operated under the ATQP;
- (B) include all crews trained and qualified under the ATQP;
- (C) be established during the implementation phase of ATQP; and
- (D) continue throughout the life of the ATQP.

- (iv) Data handling: the operator should establish a procedure to ensure the confidentiality of individual flight crew members, as described by AMC1 ORO.AOC.130.
 - (v) The operator that has a flight data monitoring programme prior to the proposed introduction of ATQP may use relevant data from other fleets not part of the proposed ATQP.
- (b) Implementation. The operator should develop an evaluation and implementation process, including the following stages:
- (1) A safety case that demonstrates equivalency of:
 - (i) the revised training and qualification standards compared to the standards of ORO.FC and/or Subpart E of Annex V (SPA.LVO) prior to the introduction of ATQP; and
 - (ii) any new training methods implemented as part of ATQP.

The safety case should encompass each phase of implementation of the programme and be applicable over the lifetime of the programme that is to be overseen. The safety case should:

- demonstrate the required level of safety;
- ensure the required safety is maintained throughout the lifetime of the programme; and
- minimise risk during all phases of the programme's implementation and operation.

The elements of a safety case include:

- planning: integrated and planned with the operation (ATQP) that is to be justified;
- criteria;
- safety-related documentation, including a safety checklist;
- programme of implementation to include controls and validity checks; and
- oversight, including review and audits.

Criteria for the establishment of a safety case. The safety case should:

- be able to demonstrate that the required or equivalent level of safety is maintained throughout all phases of the programme;
- be valid to the application and the proposed operation;
- be adequately safe and ensure the required regulatory safety standards or approved equivalent safety standards are achieved;
- be applicable over the entire lifetime of the programme;
- demonstrate completeness and credibility of the programme;
- be fully documented;
- ensure integrity of the operation and the maintenance of the operations and training infrastructure;
- ensure robustness to system change;
- address the impact of technological advance, obsolescence and change; and

- address the impact of regulatory change.
- (2) A task analysis, as required by (a)(2), to establish the operator’s programme of targeted training and the associated training objectives.
- (3) A period of operation whilst data is collected and analysed to validate the safety case and task analysis. During this period the operator should continue to operate in accordance with ORO.FC and/or Subpart E of Annex V (SPA.LVO), as applicable. The length of this period should be determined by the competent authority.

GM1 ORO.FC.A.245 Alternative training and qualification programme

TERMINOLOGY

- (a) ‘Line-oriented evaluation (LOE)’ is an evaluation methodology used in the ATQP to evaluate trainee performance, and to validate trainee proficiency. LOEs consist of flight simulator scenarios that are developed by the operator in accordance with a methodology approved as part of the ATQP. The LOE should be realistic and include appropriate weather scenarios and, in addition, should fall within an acceptable range of difficulty. The LOE should include the use of validated event sets to provide the basis for event-based assessment.
- (b) ‘Line-oriented quality evaluation (LOQE)’ is one of the tools used to help evaluate the overall performance of an operation. LOQEs consist of line flights that are observed by appropriately qualified operator personnel to provide feedback to validate the ATQP. The LOQE should be designed to look at those elements of the operation that are unable to be monitored by FDM or Advanced FDM programmes.
- (c) ‘Skill-based training’ requires the identification of specific knowledge and skills. The required knowledge and skills are identified within an ATQP as part of a task analysis and are used to provide targeted training.
- (d) ‘Event-based assessment’ is the assessment of flight crew to provide assurance that the required knowledge and skills have been acquired. This is achieved within an LOE. Feedback to the flight crew is an integral part of event-based assessment.
- (e) Safety case means a documented body of evidence that provides a demonstrable and valid justification that the ATQP is adequately safe for the given type of operation.

GM2 ORO.FC.A.245

EVIDENCE-BASED RECURRENT TRAINING AND CHECKING OF FLIGHT CREW CONDUCTED IN FLIGHT SIMULATION TRAINING DEVICES (FSTDs)

It is possible to implement EBT in accordance with ICAO Doc 9995 in the framework of an approved alternative training and qualification programme (ATQP). GM1 ORO.FC.230(a);(b);(f) may be used to guide the operator towards EBT according to ORO.FC.A.245 of Commission Regulation (EU) No 965/2012.

An operator holding approval for ATQP and wishing to implement EBT may use the guidance material in GM1 ORO.FC.230(a);(b);(f) for the conduct of the Licence Proficiency Check, or where the Licence Proficiency Check and Operator Proficiency Check are combined. For this purpose, the evaluation phase is equivalent to the line-oriented evaluation (LOE) described in ORO.FC.A.245(d).

AMC1 ORO.FC.A.245(a) Alternative training and qualification programme

OPERATOR EXPERIENCE

The appropriate experience should be at least 2 years' continuous operation.

AMC1 ORO.FC.A.245(d)(e)(2) Alternative training and qualification programme

COMBINATION OF CHECKS

- (a) The line-orientated evaluation (LOE) may be undertaken with other ATQP training.
- (b) The line check may be combined with a line-oriented quality evaluation (LOQE).

ORO.FC.A.250 Commanders holding a CPL(A)

- (a) The holder of a CPL(A) (aeroplane) shall only act as commander in commercial air transport on a single-pilot aeroplane if:
- (1) when carrying passengers under VFR outside a radius of 50 NM (90 km) from an aerodrome of departure, he/she has a minimum of 500 hours of flight time on aeroplanes or holds a valid instrument rating; or
 - (2) when operating on a multi-engine type under IFR, he/she has a minimum of 700 hours of flight time on aeroplanes, including 400 hours as pilot-in-command. These hours shall include 100 hours under IFR and 40 hours in multi-engine operations. The 400 hours as pilot-in-command may be substituted by hours operating as co-pilot within an established multi-pilot crew system prescribed in the operations manual, on the basis of two hours of flight time as co-pilot for one hour of flight time as pilot-in command.
- (b) For operations under VFR by day of performance class B aeroplanes (a)(1) shall not apply.

ORO.FC.H.250 Commanders holding a CPL(H)

- (a) The holder of a CPL(H) (helicopter) shall only act as commander in commercial air transport on a single-pilot helicopter if:
- (1) when operating under IFR, he/she has a minimum of 700 hours total flight time on helicopters, including 300 hours as pilot-in-command. These hours shall include 100 hours under IFR. The 300 hours as pilot-in-command may be substituted by hours operating as co-pilot within an established multi-pilot crew system prescribed in the operations manual on the basis of two hours of flight time as co-pilot for one hour flight time as pilot-in command;
 - (2) when operating under visual meteorological conditions (VMC) at night, he/she has:
 - (i) a valid instrument rating; or
 - (ii) 300 hours of flight time on helicopters, including 100 hours as pilot-in-command and 10 hours as pilot flying at night.

SECTION 3***Additional requirements for commercial specialised operations and CAT operations referred to in ORO.FC.005(b)(1) and (2)*****ORO.FC.330 Recurrent training and checking — operator proficiency check**

- (a) Each flight crew member shall complete operator proficiency checks to demonstrate his/her competence in carrying out normal, abnormal and emergency procedures, covering the relevant aspects associated with the specialised tasks described in the operations manual.
- (b) Appropriate consideration shall be given when operations are undertaken under IFR or at night.
- (c) The validity period of the operator proficiency check shall be 12 calendar months. The validity period shall be counted from the end of the month when the check was taken. When the operator proficiency check is undertaken within the last three months of the validity period, the new validity period shall be counted from the original expiry date.

SUBPART CC: CABIN CREW

ORO.CC.005 Scope

This Subpart establishes the requirements to be met by the operator when operating an aircraft with cabin crew and comprises:

- (a) Section 1 specifying common requirements applicable to all operations; and
- (b) Section 2 specifying additional requirements only applicable to commercial air transport operations.

SECTION 1 Common requirements

ORO.CC.100 Number and composition of cabin crew

- (a) The number and composition of cabin crew shall be determined in accordance with 7.a of Annex IV to Regulation (EC) No 216/2008, taking into account operational factors or circumstances of the particular flight to be operated. Except for balloons, at least one cabin crew member shall be assigned for the operation of aircraft with an MOPSC of more than 19 when carrying one or more passenger(s).
- (b) For the purpose of complying with (a), the minimum number of cabin crew shall be the greater of the following:
 - (1) the number of cabin crew members established during the aircraft certification process in accordance with the applicable certification specifications, for the aircraft cabin configuration used by the operator; or
 - (2) if the number under (1) has not been established, the number of cabin crew established during the aircraft certification process for the maximum certified passenger seating configuration reduced by 1 for every whole multiple of 50 passenger seats of the aircraft cabin configuration used by the operator falling below the maximum certified seating capacity; or
 - (3) one cabin crew member for every 50, or fraction of 50, passenger seats installed on the same deck of the aircraft to be operated.
- (c) For operations where more than one cabin crew member is assigned, the operator shall nominate one cabin crew member to be responsible to the pilot-in-command/commander.

AMC1 ORO.CC.100 Number and composition of cabin crew

DETERMINATION OF THE NUMBER AND COMPOSITION OF CABIN CREW

- (a) When determining the minimum number of cabin crew required to operate aircraft engaged in CAT operations, factors to be taken into account should include:
 - (1) the number of doors/exits;

- (2) the type(s) of doors/exits and the associated assisting evacuation means;
 - (3) the location of doors/exits in relation to cabin crew stations and the cabin layout;
 - (4) the location of cabin crew stations taking into account direct view requirements and cabin crew duties in an emergency evacuation including:
 - (i) opening floor level doors/exits and initiating stair or slide deployment;
 - (ii) assisting passengers to pass through doors/exits; and
 - (iii) directing passengers away from inoperative doors/exits, crowd control and passenger flow management;
 - (5) actions required to be performed by cabin crew in ditching, including the deployment of slide-rafts and the launching of life-rafts;
 - (6) additional actions required to be performed by cabin crew members when responsible for a pair of doors/exits; and
 - (7) the type and duration of the flight to be operated.
- (b) When scheduling cabin crew for a flight, the operator should establish procedures that take account of the experience of each cabin crew member. The procedures should specify that the required cabin crew includes some cabin crew members who have at least 3 months experience as an operating cabin crew member.

GM1 ORO.CC.100 Number and composition of cabin crew

MINIMUM NUMBER OF CABIN CREW

- (a) When determining the minimum required cabin crew for its specific aircraft cabin configuration, the operator should:
- (1) request information regarding the minimum number of cabin crew established by the aircraft type certificate (TC) holder or other design organisation responsible for showing compliance with the evacuation requirements of the applicable Certification Specifications; and
 - (2) take into account the factors specified in AMC1 ORO.CC.100, as applicable.
- (b) The number of cabin crew referred to in ORO.CC.100 (b)(1) means either:
- (1) the number of cabin crew who actively participated in the aircraft cabin during the relevant emergency evacuation demonstration, or who were assumed to have taken part in the relevant analysis, carried out by the aircraft TC holder when demonstrating the maximum passenger seating capacity (MPSC) of the aircraft type at the time of initial type certification; or
 - (2) a lower number of cabin crew who actively participated in a subsequent emergency evacuation demonstration, or who were assumed to have taken part in the relevant analysis, and for which approval has been obtained for a cabin configuration other than the MPSC, either by the TC holder or by another design organisation. The operator should obtain a clear indication of that number which is specified in the related documentation. If a lower number is not specified, the number of cabin crew established at the time of initial type certification applies.

ORO.CC.110 Conditions for assignment to duties

- (a) Cabin crew members shall only be assigned to duties on an aircraft if they:
- (1) are at least 18 years of age;
 - (2) have been assessed, in accordance with the applicable requirements of Annex IV (Part-MED) to Regulation (EU) No 1178/2011, as physically and mentally fit to perform their duties and discharge their responsibilities safely; and
 - (3) have successfully completed all applicable training and checking required by this Subpart and are competent to perform the assigned duties in accordance with the procedures specified in the operations manual.
- (b) Before assigning to duties cabin crew members who are working on a freelance or part-time basis, the operator shall verify that all applicable requirements of this Subpart are complied with, taking into account all services rendered by the cabin crew member to any other operator(s), to determine in particular:
- (1) the total number of aircraft types and variants operated; and
 - (2) the applicable flight and duty time limitations and rest requirements.
- (c) Operating cabin crew members, as well as their role with regard to the safety of passengers and flight, shall be clearly identified to the passengers.

ORO.CC.115 Conduct of training courses and associated checking

- (a) A detailed programme and syllabus shall be established by the operator for each training course in accordance with the applicable requirements of this Subpart, and of Annex V (Part-CC) to Regulation (EU) No 1178/2011 where applicable, to cover the duties and responsibilities to be discharged by the cabin crew members.
- (b) Each training course shall include theoretical and practical instruction together with individual or collective practice, as relevant to each training subject, in order that the cabin crew member achieves and maintains the adequate level of proficiency in accordance with this Subpart.
- (c) Each training course shall be:
- (1) conducted in a structured and realistic manner; and
 - (2) performed by personnel appropriately qualified for the subject to be covered.
- (d) During or following completion of all training required by this Subpart, each cabin crew member shall undergo a check covering all training elements of the relevant training programme, except for crew resource management (CRM) training. Checks shall be performed by personnel appropriately qualified to verify that the cabin crew member has achieved and/or maintains the required level of proficiency.
- (e) CRM training courses and CRM modules where applicable shall be conducted by a cabin crew CRM instructor. When CRM elements are integrated in other training, a cabin crew CRM instructor shall manage the definition and implementation of the syllabus.

GM1 ORO.CC.115 Conduct of training courses and associated checking**EQUIPMENT AND PROCEDURES**

The following definitions apply for the purpose of training programmes, syllabi and the conduct of training and checking on equipment and procedures:

- (a) ‘Safety equipment’ means equipment installed/carried to be used during day-to-day normal operations for the safe conduct of the flight and protection of occupants (e.g. seat belts, child restraint devices, safety card, safety demonstration kit).
- (b) ‘Emergency equipment’ means equipment installed/carried to be used in case of abnormal and emergency situations that demand immediate action for the safe conduct of the flight and protection of occupants, including life preservation (e.g. drop-out oxygen, crash axe, fire extinguisher, protective breathing equipment, manual release tool, slide-raft).
- (c) ‘Normal procedures’ means all procedures established by the operator in the operations manual for day-to-day normal operations (e.g. pre-flight briefing of cabin crew, pre-flight checks, passenger briefing, securing of galleys and cabin, cabin surveillance during flight).
- (d) ‘Emergency procedures’ means all procedures established by the operator in the operations manual for abnormal and emergency situations. For this purpose, ‘abnormal’ refers to a situation that is not typical or usual, deviates from normal operation and may result in an emergency.

AMC1 ORO.CC.115(c) Conduct of training courses and associated checking

TRAINING METHODS AND TRAINING DEVICES

- (a) The operator should establish training methods that take into account the following:
 - (1) training should include the use of cabin training devices, audio-visual presentations, computer-based training and other types of training, as most appropriate to the training element; and
 - (2) a reasonable balance between the different training methods should be ensured so that the cabin crew member achieves the level of proficiency necessary for a safe performance of all related cabin crew duties and responsibilities.
- (b) When assessing the representative training devices to be used, the operator should:
 - (1) take into account that a representative training device may be used to train cabin crew as an alternative to the use of the actual aircraft or required equipment;
 - (2) ensure that those items relevant to the training and checking intended to be given accurately represent the aircraft or equipment in the following particulars:
 - (i) layout of the cabin in relation to doors/exits, galley areas and safety and emergency equipment stowage as relevant;
 - (ii) type and location of passenger seats and cabin crew stations;
 - (iii) doors/exits in all modes of operation, particularly in relation to the method of operation, mass and balance and operating forces, including failure of power-assist systems where fitted; and
 - (iv) safety and emergency equipment of the type provided in the aircraft (such equipment may be ‘training use only’ items and, for oxygen and protective breathing equipment, units charged with or without oxygen may be used); and
 - (3) assess the following factors when determining whether a door/exit can be considered to be a variant of another type:
 - (i) door/exit arming/disarming;
 - (ii) direction of movement of the operating handle;

- (iii) direction of door/exit opening;
- (iv) power-assist mechanisms; and
- (v) assisting evacuation means such as slides and ropes.

AMC1 ORO.CC.115(d) Conduct of training courses and associated checking

CHECKING

- (a) Checking required for each training course should be accomplished by the method appropriate to the training element to be checked. These methods include:
 - (1) practical demonstration;
 - (2) computer-based assessment;
 - (3) in-flight checks;
 - (4) oral or written tests.
- (b) Training elements that require individual practical participation may be combined with practical checks.

AMC1 ORO.CC.115(e) Conduct of training courses and associated checking

RESOURCE MANAGEMENT (CRM) TRAINING – MULTI CABIN CREW OPERATIONS

- (a) General
 - (1) Training environment

CRM training should be conducted in the non-operational environment (classroom and computer-based) and in the operational environment (cabin training device and aircraft). Tools such as group discussions, team task analysis, team task simulation and feedback should be used.
 - (2) Classroom training

Whenever possible, classroom training should be conducted in a group session away from the pressures of the usual working environment, so that the opportunity is provided for cabin crew members to interact and communicate in an environment conducive to learning.
 - (3) Computer-based training

Computer-based training should not be conducted as a stand-alone training method, but may be conducted as a complementary training method.
 - (4) Cabin training devices and aircraft

Whenever practicable, relevant parts of CRM training should be conducted in representative cabin training devices that reproduce a realistic operational environment, or in the aircraft. During practical training, interaction should be encouraged.
 - (5) Integration into cabin crew training

CRM principles should be integrated into relevant parts of cabin crew training and operations, including checklists, briefings and emergency procedures.
 - (6) Combined CRM training for flight crew and cabin crew

- (i) Operators should provide combined training for flight crew and cabin crew during recurrent CRM training.
 - (ii) The combined training should address at least:
 - (A) effective communication, coordination of tasks and functions of flight crew and cabin crew; and
 - (B) mixed multinational and cross-cultural flight crew and cabin crew, and their interaction, if applicable.
 - (iii) Combined CRM training should be conducted by flight crew CRM trainer or cabin crew CRM trainer.
 - (iv) There should be an effective liaison between flight crew and cabin crew training departments. Provision should be made for transfer of relevant knowledge and skills between flight crew and cabin crew CRM trainers.
- (7) Management system
- CRM training should address hazards and risks identified by the operator's management system described in ORO.GEN.200.
- (8) Competency-based CRM training
- Whenever practicable, the compliance-based approach concerning CRM training may be substituted by a competency-based approach. In this context, CRM training should be characterised by a performance orientation, with emphasis on standards of performance and their measurement, and the development of training to the specified performance standards.
- (9) Contracted CRM training
- If the operator chooses not to establish its own CRM training, another operator, a third party or a training organisation may be contracted to provide the training in accordance with ORO.GEN.205. In case of contracted CRM training, the operator should ensure that the content of the course covers the specific culture, the type of operations and the associated procedures of the operator. When crew members from different operators attend the same course, the CRM training should be specific to the relevant flight operations and to the trainees concerned.
- (b) Operator's CRM training
- The operator's CRM training should cover all elements listed in Table 1 of (g). Several training elements are specified as 'not required' for the operator's CRM training, since they are covered under the introductory CRM course for cabin crew as required in Annex V (Part-CC) to Commission Regulation (EU) No 1178/2011.
- (c) Operator aircraft type conversion CRM training
- If the cabin crew member undertakes the operator's conversion training on an aircraft type, the applicable CRM training elements should be covered as specified in Table 1 of (g).
- (d) Annual recurrent CRM training
- (1) Annual recurrent CRM training should be provided in such a way that all CRM training elements specified for the annual recurrent training in Table 1 of (g) are covered over a period not exceeding 3 years.

-
- (2) Operators should update their recurrent CRM training programme over a period not exceeding 3 years. The revision of the programme should take into account information from the operator's management system.
- (e) Senior cabin crew member course
- (1) CRM training for senior cabin crew members should be the application of knowledge gained in previous CRM training and operational experience relevant to the specific duties and responsibilities of a senior cabin crew member. The operator should ensure that for the senior cabin crew member course the CRM training elements are integrated into the training, as specified in Table 1 of (g).
- (2) During the training the senior cabin crew member should demonstrate the ability:
- (i) to manage the operation; and
 - (ii) to take appropriate leadership and management decisions.
- (f) Training elements
- The CRM training elements to be covered are specified in Table 1 of (g). The operator should ensure that the following aspects are addressed:
- (1) Resilience development
- CRM training should address the main aspects of resilience development. The training should cover:
- (i) Mental flexibility
Cabin crew should be trained to:
 - (A) understand that mental flexibility is necessary to recognise critical changes;
 - (B) reflect on their judgement and adjust it to the unique situation;
 - (C) avoid fixed prejudices and over-reliance on standard solutions; and
 - (D) remain open to changing assumptions and perceptions.
 - (ii) Performance adaptation
Cabin crew should be trained to:
 - (A) mitigate frozen behaviours, overreactions and inappropriate hesitation; and
 - (B) adjust actions to current conditions.
- (2) Surprise and startle effect
- CRM training should address unexpected, unusual and stressful situations including interruptions and distractions. Therefore, CRM training should be designed to prepare cabin crew to master sudden events and associated uncontrolled reactions.
- (3) Cultural differences
- CRM training should cover cultural differences of multinational and cross-cultural crews. This includes recognising that:
- (i) different cultures may have different communication specifics, ways of understanding and approaches to the same situation or problem;
 - (ii) difficulties may arise when crew members with different mother tongue communicate in a common language which is not their mother tongue; and

- (iii) cultural differences may lead to different methods for identifying a situation and solving a problem.
- (4) Operator’s safety culture and company culture
CRM training should cover the operator’s safety culture, its company culture, the type of operations and the associated procedures of the operator. This should include areas of operations that may lead to particular difficulties or involve unusual hazards.
- (5) Case studies
 - (i) CRM training should cover aircraft type-specific case studies, based on the information available within the operator’s management system, including:
 - (A) accident and serious incident reviews to analyse and identify any associated non-technical causal and contributory factors, and instances or examples of lack of CRM; and
 - (B) analysis of occurrences that were well managed.
 - (ii) If relevant aircraft type-specific or operator-specific case studies are not available, the operator should consider other case studies relevant to the scale and scope of its operations.
- (g) CRM training syllabus

Table 1 below specifies which CRM training elements should be covered in each type of training. The levels of training in Table 1 can be described as follows:

- (1) ‘Required’ means training that should be instructional or interactive in style to meet the objectives specified in the CRM training programme or to refresh and strengthen knowledge gained in a previous training.
- (2) ‘In-depth’ means training that should be instructive or interactive in style taking full advantage of group discussions, team task analysis, team task simulation, etc., for the acquisition or consolidation of knowledge, skills and attitudes. The CRM training elements should be tailored to the specific needs of the training phase being undertaken.

Table 1 — Cabin crew CRM training

CRM training elements	Operator’s CRM training	Operator aircraft type conversion training	Annual recurrent training	Senior cabin crew member (SCC) course
General principles				
Human factors in aviation; General instructions on CRM principles and objectives; Human performance and limitations; Threat and error management.	Not required (covered under initial training required by Part-CC)	Required	Required	Required
Relevant to the individual cabin crew member				

Personality awareness, human error and reliability, attitudes and behaviours, self-assessment and self-critique; Stress and stress management; Fatigue and vigilance; Assertiveness, situation awareness, information acquisition and processing.	Not required (covered under initial training required by Part-CC)	Required	Required (3-year cycle)	Required
Relevant to the entire aircraft crew				
Shared situation awareness, shared information acquisition and processing; Workload management; Effective communication and coordination between all crew members including the flight crew as well as inexperienced cabin crew members; Leadership, cooperation, synergy, delegation, decision-making, actions; Resilience development; Surprise and startle effect; Cultural differences; Identification and management of the passenger human factors: crowd control, passenger stress, conflict management, medical factors.	In-depth	Required when relevant to the type(s)	Required (3-year cycle)	In-depth
Specifics related to aircraft types (narrow-/wide-bodied, single-/multi-deck), flight crew and cabin crew composition and number of passengers	Required	In-depth	Required (3-year cycle)	In-depth
Relevant to the operator and the organisation				
Operator's safety culture and company culture, standard operating procedures (SOPs), organisational factors, factors linked to the type of operations; Effective communication and coordination with other	In-depth	Required when relevant to the type(s)	Required (3-year cycle)	In-depth

operational personnel and ground services; Participation in cabin safety incident and accident reporting.				
Case- studies	In-depth	Required when relevant to the type(s)	In-depth	In-depth

AMC2 ORO.CC.115(e) Conduct of training courses and associated checking

CREW RESOURCE MANAGEMENT (CRM) TRAINING — SINGLE CABIN CREW OPERATIONS

For single cabin crew operations, AMC1 ORO.CC.115(e) should be applied with the following differences:

(a) Relevant training elements

CRM training should focus on the elements specified in Table 1 of (g) of AMC1 ORO.CC.115(e) which are relevant to single cabin crew operations. Therefore, single cabin crew CRM training should include, among others:

- (1) situation awareness;
- (2) workload management;
- (3) decision-making;
- (4) resilience development;
- (5) surprise and startle effect; and
- (6) effective communication and coordination with
 - (i) the flight crew; and
 - (ii) other operational personnel and ground services.

(b) Computer-based training

Notwithstanding (a)(3) of AMC1 ORO.CC.115(e), computer-based training may be conducted as a stand-alone training method for a cabin crew member operating on aircraft with a maximum operational passenger seating configuration of 19 or less.

AMC3 ORO.CC.115(e) Conduct of training courses and associated checking

CABIN CREW CRM TRAINER

(a) Applicability

The provisions described herein:

- (1) should be fulfilled by cabin crew CRM trainers responsible for classroom CRM training; and

-
- (2) are not applicable to trainers or instructors conducting training other than CRM training, but integrating CRM elements into this training. Nevertheless, trainers or instructors who are integrating CRM elements into the aircraft type training, recurrent training or senior cabin crew member training should have acquired relevant knowledge of human performance and limitations, and have completed appropriate CRM training.
- (b) Qualification of cabin crew CRM trainer
- (1) A training and standardisation programme for cabin crew CRM trainers should be established.
- (2) The cabin crew CRM trainer, in order to be suitably qualified, should:
- (i) have adequate knowledge of the relevant flight operations;
 - (ii) have received instructions on human performance and limitations (HPL);
 - (iii) have completed an introductory CRM course, as required in Annex V (Part-CC) to Commission Regulation (EU) No 1178/2011, and an operator's CRM training, as specified in AMC1 ORO.CC.115(e);
 - (iv) have received training in group facilitation skills;
 - (v) have received additional training in the fields of group management, group dynamics and personal awareness; and
 - (vi) have demonstrated the knowledge, skills and credibility required to train the CRM training elements in the non-operational environment, as specified in Table 1 of AMC1 ORO.CC.115(e).
- (3) An experienced CRM trainer may become a cabin crew CRM trainer if he/she demonstrates a satisfactory knowledge of the relevant flight operations and the cabin crew working environment, and fulfils the provisions specified in (2)(ii) to (2)(vi).
- (c) Training of cabin crew CRM trainer
- (1) Training of cabin crew CRM trainers should be both theoretical and practical. Practical elements should include the development of specific trainer skills, particularly the integration of CRM into day-to-day operations.
- (2) The basic training of cabin crew CRM trainers should include the training elements for cabin crew, as specified in Table 1 of AMC1 ORO.CC.115(e). In addition, the basic training should include the following:
- (i) introduction to CRM training;
 - (ii) operator's management system; and
 - (iii) characteristics, as applicable:
 - (A) of the different types of CRM trainings (initial, recurrent, etc.);
 - (B) of combined training; and
 - (C) related to the type of aircraft or operation.
- (3) The refresher training of cabin crew CRM trainers should include new methodologies, procedures and lessons learned.
- (4) The training of cabin crew CRM trainers should be conducted by cabin crew CRM trainers with a minimum of 3 years' experience. Assistance may be provided by experts in order to address specific areas.

- (d) Assessment of cabin crew CRM trainer
- (1) A cabin crew CRM trainer should be assessed by the operator when conducting the first CRM training course. This first assessment should be valid for a period of 3 years.
 - (2) Assessment is the process of observing, recording, interpreting and debriefing the cabin crew CRM trainer. The operator should describe the assessment process in the operations manual. All personnel involved in the assessment must be credible and competent in their role.
- (e) Recency and renewal of qualification as cabin crew CRM trainer
- (1) For recency of the 3-year validity period, the cabin crew CRM trainer should:
 - (i) conduct at least 2 CRM training events in any 12-month period;
 - (ii) be assessed within the last 12 months of the 3-year validity period by the operator; and
 - (iii) complete CRM trainer refresher training within the 3-year validity period.
 - (2) The next 3-year validity period should start at the end of the previous period.
 - (3) For renewal, i.e. when a cabin crew CRM trainer does not fulfil the provisions of (1), he/she should, before resuming as cabin crew CRM trainer:
 - (i) comply with the qualification provisions of (b) and (d); and
 - (ii) complete CRM trainer refresher training.

GM1 ORO.CC.115(e) Conduct of training courses and associated checking

CRM – GENERAL

- (a) CRM is the effective utilisation of all available resources (e.g. crew members, aircraft systems, and supporting facilities) to achieve safe and efficient operation.
- (b) The objective of CRM is to enhance the communication and management skills of the crew member, as well as the importance of effective coordination and two-way communication between all crew members.

GM2 ORO.CC.115(e) Crew resource management (CRM) training

MINIMUM TRAINING TIMES

- (a) The following minimum training times are appropriate:
 - (1) multi cabin crew operations:
 - (i) combined CRM training: 6 training hours over a period of 3 years; and
 - (ii) operator's CRM training: 6 training hours;
 - (2) operator's CRM training for single cabin crew operations: 4 training hours for a cabin crew member operating on aircraft with a maximum operational passenger seating configuration of 19 or less;
 - (3) cabin crew CRM trainer:
 - (i) basic training:

- (A) 18 training hours when the operator can justify that the trainee already has received sufficient and suitable instruction on training skills in order to conduct CRM training courses; or
 - (B) 30 training hours for trainees not fulfilling (A); and
 - (ii) refresher training: 6 training hours.
- (b) ‘Training hours’ means actual training time excluding breaks.

GM3 ORO.CC.115(e) Crew resource management (CRM) training

DESIGN, IMPLEMENTATION AND EVALUATION OF CRM TRAINING

The checklist in Table 1 provides guidance on the design, implementation and evaluation of CRM training, and on their incorporation into the operator’s safety culture. Elements of the operator’s management systems and the competency-based approach are incorporated in the checklist.

Table 1 — Checklist for design, implementation, evaluation and incorporation of CRM training

Step No	Description	Element
1	Needs analysis	Determine the necessary CRM competencies
		Develop CRM training goals
		Ensure the organisation is ready for CRM training
2	Design	Develop CRM training objectives
		Determine what to measure and how to measure it
3	Development	Describe the CRM learning environment
		Develop full-scale prototype of training
		Validate and modify CRM training
4	Implementation	Prepare trainees and environment
		Set a climate for learning (e.g. practice and feedback)
		Implement the CRM training programme
5	Evaluation	Determine training effectiveness
		Evaluate CRM training at multiple levels
		Revise the CRM training programme to improve effectiveness
6	Incorporation	Establish an environment where CRM training is positively recognised
		Reinforce CRM behaviours in daily work
		Provide recurrent CRM training

GM4 ORO.CC.115(e) Crew resource management (CRM) training

RESILIENCE DEVELOPMENT

- (a) The main aspects of resilience development can be described as the ability to:
 - (1) learn (‘knowing what has happened’);

- (2) monitor ('knowing what to look for');
 - (3) anticipate ('finding out and knowing what to expect'); and
 - (4) respond ('knowing what to do and being capable of doing it').
- (b) Operational safety is a continuous process of evaluation of and adjustment to existing and future conditions. In this context, and following the description in (a), resilience development involves an ongoing and adaptable process including situation assessment, self-review, decision and action. Training on resilience development enables crew members to draw the right conclusions from both positive and negative experiences. Based on those experiences, crew members are better prepared to maintain or create safety margins by adapting to dynamic complex situations.
- (c) The training topics in (f)(1) of AMC1 ORO.CC.115(e) are to be understood as follows:
- (1) Mental flexibility
 - (i) The phrase 'understand that mental flexibility is necessary to recognise critical changes' means that crew members are prepared to respond to situations for which there is no set procedure.
 - (ii) The phrase 'reflect on their judgement and adjust it to the unique situation' means that crew members learn to review their judgement based on the unique characteristics of the given circumstances.
 - (iii) The phrase 'avoid fixed prejudices and over-reliance on standard solutions' means that crew members learn to update solutions and standard response sets, which have been formed on prior knowledge.
 - (iv) The phrase 'remain open to changing assumptions and perceptions' means that crew members constantly monitor the situation, and are prepared to adjust their understanding of the evolving conditions.
 - (2) Performance adaptation
 - (i) The phrase 'mitigate frozen behaviours, overreactions and inappropriate hesitation' means that crew members correct improper actions with a balanced response.
 - (ii) The phrase 'adjust actions to current conditions' means that crew members' responses are in accordance with the actual situation.

GM5 ORO.CC.115(e) Conduct of training courses and associated checking

CABIN CREW CRM TRAINER ASSESSMENT

- (a) For assessing cabin crew CRM trainers, the operator may nominate experienced cabin crew CRM trainers who have demonstrated continued compliance with the provisions for a cabin crew CRM trainer and capability in that role for at least 3 years.
- (b) An operator that does not have the resources to conduct the assessment may employ a contractor. The standard as regards the assessment is confirmed on a 3-year basis by the operator.
- (c) The checklist in Table 1 provides guidance on the assessment of a cabin crew CRM trainer. If a cabin crew CRM trainer is competent in his/her role, the response to the questions in Table 1 should be 'yes'. When answering the questions in Table 1, justifications and examples related to the responses given should be provided.

Table 1 — Cabin crew CRM trainer assessment checklist

Questions to assess a cabin crew CRM trainer	Response yes/no
Did the CRM trainer demonstrate the knowledge required for the role?	
Did the CRM trainer support CRM concepts?	
Did the CRM trainer encourage trainees to participate, share their experiences and self-analyse?	
Did the CRM trainer identify and respond to the trainees' needs relative to expertise/experience?	
Did the CRM trainer show how CRM is integrated in technical training?	
Did the CRM trainer incorporate company CRM standards when appropriate?	
Did the CRM trainer identify and discuss the non-technical reasons involved in accidents, incidents and events included in case studies?	
Did the CRM trainer regularly check for understanding and resolve ambiguities?	
Did the CRM trainer demonstrate effective instruction and facilitation skills?	

ORO.CC.120 Initial training course

- (a) Each new entrant who does not already hold a valid cabin crew attestation issued in accordance with Annex V (Part-CC) to Regulation (EU) No 1178/2011:
- (1) shall be provided with an initial training course as specified in CC.TRA.220 of that Annex; and
 - (2) shall successfully undergo the associated examination before undertaking other training required by this Subpart.
- (b) Elements of the initial training programme may be combined with the first aircraft type specific training and operator conversion training, provided that the requirements of CC.TRA.220 are met and any such element(s) are recorded as elements of the initial training course in the training records of the cabin crew members concerned.

AMC1 ORO.CC.120(a)(1) Initial training course

NEW ENTRANTS IN OPERATIONS OTHER THAN CAT OPERATIONS

- (a) When a new entrant to an operator conducting operations other than CAT is a cabin crew member, not holding a valid cabin crew attestation, who has already acquired experience as cabin crew in operations other than CAT, credit may be granted to the elements of the initial training programme he/she has previously completed if such training elements are documented in his/her training records.
- (b) In such a case, the operator should ensure that:
- (1) the full training programme, as specified in Appendix 1 to Part-CC, has been covered, and
 - (2) the new entrant successfully undergoes the examination required by ORO.CC.120(a)(2).

ORO.CC.125 Aircraft type specific training and operator conversion training

- (a) Each cabin crew member shall have completed appropriate aircraft type specific training and operator conversion training, as well as the associated checks, before being:
- (1) first assigned by the operator to operate as a cabin crew member; or
 - (2) assigned by that operator to operate on another aircraft type.
- (b) When establishing the aircraft type specific and the operator conversion training programmes and syllabi, the operator shall include, where available, the relevant elements defined in the mandatory part of the operational suitability data established in accordance with Regulation (EU) No 748/2012.
- (c) The aircraft type specific training programme shall:
- (1) involve training and practice on a representative training device or on the actual aircraft; and
 - (2) cover at least the following aircraft type specific training elements:
 - (i) aircraft description as relevant to cabin crew duties;
 - (ii) all safety equipment and systems installed relevant to cabin crew duties;
 - (iii) operation and actual opening, by each cabin crew member, of each type or variant of normal and emergency doors and exits in the normal and emergency modes;
 - (iv) demonstration of the operation of the other exits including flight crew compartment windows;
 - (v) fire and smoke protection equipment where installed;
 - (vi) evacuation slide training, where fitted;
 - (vii) operation of the seat, restraint system and oxygen system equipment relevant to pilot incapacitation.
- (d) The operator conversion training programme for each aircraft type to be operated shall:
- (1) involve training and practice on a representative training device or on the actual aircraft;
 - (2) include training in the operator's standard operating procedures for cabin crew members to be first assigned to duties by the operator;
 - (3) cover at least the following operator specific training elements as relevant to the aircraft type to be operated:
 - (i) description of the cabin configuration;
 - (ii) location, removal and use of all portable safety and emergency equipment carried on-board;
 - (iii) all normal and emergency procedures;
 - (iv) passenger handling and crowd control;
 - (v) fire and smoke training including the use of all related fire-fighting and protective equipment representative of that carried on-board;
 - (vi) evacuation procedures;
 - (vii) pilot incapacitation procedures;
 - (viii) applicable security requirements and procedures;

- (ix) crew resource management.

AMC1 ORO.CC.125(c) Aircraft type specific training and operator conversion training

TRAINING PROGRAMME — AIRCRAFT TYPE SPECIFIC TRAINING

The following aircraft type specific training elements should be covered as relevant to the aircraft type:

(a) Aircraft description

- (1) type of aircraft, principal dimensions, narrow or wide bodied, single or double deck;
- (2) speed, altitude, range;
- (3) passenger seating capacity;
- (4) flight crew number and minimum number of required cabin crew;
- (5) cabin doors/exits location and sill height;
- (6) cargo and unpressurised areas as relevant;
- (7) aircraft systems relevant to cabin crew duties;
- (8) flight crew compartment — general presentation, pilot seats and their mechanism, emergency exits, storage;
- (9) required cabin crew stations;
- (10) flight crew compartment security — general: door components and use;
- (11) access to avionics bay where relevant;
- (12) lavatories — general: doors, systems, calls and signs; and
- (13) least risk bomb location.

(b) Safety and emergency equipment and aircraft systems installed

Each cabin crew member should receive realistic training on, and demonstration of, the location and use of all aircraft type specific safety and emergency equipment and aircraft systems installed, with emphasis on the following:

- (1) slides, and where non-self-supporting slides are carried, the use of any associated assisting evacuation means;
- (2) life-rafts and slide-rafts, including the equipment attached to, and/or carried in, the raft;
- (3) drop-out oxygen system; and
- (4) communication equipment.

(c) Operation of doors and exits

This training should be conducted in a representative training device or in the actual aircraft and should include failure of power assist systems where fitted and the action and forces required to operate and deploy evacuation slides. Training should also include operation and actual opening of the flight crew compartment security door when installed.

(d) Fire and smoke protection equipment

Each cabin crew member should be trained in using fire and/or smoke protection equipment where fitted.

(e) Evacuation slide training

- (1) Each cabin crew member should descend an evacuation slide from a height representative of the aircraft main deck sill height.
 - (2) The slide should be fitted to a representative training device or to the actual aircraft.
 - (3) A further descent should be made when the cabin crew member qualifies on an aircraft type in which the main deck exit sill height differs significantly from any aircraft type previously operated.
- (f) Operation of equipment related to pilot incapacitation
- The training should cover any type specific elements or conditions relevant to cabin crew actions to be taken in case of pilot incapacitation. Each cabin crew member should be trained to operate all equipment that must be used in case of pilot incapacitation.

AMC1 ORO.CC.125(d) Aircraft type-specific training and operator conversion training**TRAINING PROGRAMME — OPERATOR CONVERSION TRAINING**

The following training elements should be covered as relevant to the aircraft type and the related operator's specifics:

(a) Description of the cabin configuration

The description should cover all elements specific to the operator's cabin configuration and any differences with those previously covered in accordance with AMC1 ORO.CC.125(c), including:

- (1) required and additional cabin crew stations — location (including direct view), restraint systems, control panels;
- (2) passenger seats — general presentation and associated operator's specific features and equipment;
- (3) designated stowage areas;
- (4) lavatories — operator's specific features, equipment and systems additional to the aircraft type specific elements;
- (5) galley — location, appliances, water and waste system, including shut-off, sinks, drains, stowage, control panels, calls and signs;
and where applicable
- (6) crew rest areas — location, systems, controls, safety and emergency equipment;
- (7) cabin dividers, curtains, partitions;
- (8) lift location, use, controls;
- (9) stowage for the containment of waste; and
- (10) passenger hand rail system or alternative means.

(b) Safety and emergency equipment

Each cabin crew member should receive realistic training on and demonstration of the location and use of all safety and emergency equipment carried, including:

- (1) life jackets, infant life jackets and flotation devices;
- (2) first-aid and drop-out oxygen, including supplementary systems;
- (3) fire extinguishers and protective breathing equipment (PBE);
- (4) crash axe or crowbar;

- (5) emergency lights including torches;
- (6) communication equipment, including megaphones;
- (7) slide rafts and life rafts' survival packs and their contents;
- (8) pyrotechnics (actual or representative devices);
- (9) first-aid kits, emergency medical kits and their contents; and
- (10) other portable safety and emergency equipment, where applicable.

(c) Normal and emergency procedures

Each cabin crew member should be trained on the operator's normal and emergency procedures as applicable, with emphasis on the following:

- (1) passenger briefing, safety demonstration and cabin surveillance;
- (2) severe air turbulence;
- (3) non-pressurisation, slow and sudden decompression, including the donning of portable oxygen equipment by each cabin crew member;
- (4) other in-flight emergencies; and
- (5) carriage of special categories of passengers (SCPs).

(d) Passenger handling and crowd control

Training should be provided on the practical aspects of passenger preparation and handling, as well as crowd control, in various emergency situations as applicable to the operator's specific aircraft cabin configuration, and should cover the following:

- (1) communications between flight crew and cabin crew and use of all communications equipment, including the difficulties of coordination in a smoke-filled environment;
- (2) verbal commands;
- (3) the physical contact that may be needed to encourage people out of a door/exit and onto a slide;
- (4) redirection of passengers away from unusable doors/exits;
- (5) marshalling of passengers away from the aircraft;
- (6) evacuation of special categories of passengers with emphasis on passengers with disabilities or reduced mobility; and
- (7) authority and leadership.

(e) Fire and smoke training

- (1) Each cabin crew member should receive realistic and practical training in the use of all fire-fighting equipment, including protective clothing representative of that carried in the aircraft.
- (2) Each cabin crew member should:
 - (i) extinguish an actual fire characteristic of an aircraft interior fire except that, in the case of halon extinguishers, an alternative extinguishing agent may be used; and
 - (ii) exercise the donning and use of PBE in an enclosed simulated smoke-filled environment with particular emphasis on identifying the actual source of fire and smoke.

(f) Evacuation procedures

Training should include all the operator's procedures that are applicable to planned or unplanned evacuations on land and water. It should also include, where relevant, the additional actions required from cabin crew members responsible for a pair of doors/exits and the recognition of when doors/exits are unusable or when evacuation equipment is unserviceable.

(g) Pilot incapacitation procedures

Unless the minimum flight crew is more than two, each cabin crew member should be trained in the procedure for pilot incapacitation. Training in the use of flight crew checklists, where required by the operator's standard operating procedures (SOPs), should be conducted by a practical demonstration.

(h) CRM

- (1) The operator should ensure that all applicable CRM training elements, as specified in Table 1 of AMC1 ORO.CC.115(e), are covered to the level required in the column 'Operator aircraft type conversion training'.
- (2) The operator's CRM training and the CRM training covered during the operator aircraft type conversion training should be conducted by at least one cabin crew CRM instructor.

AMC1 ORO.CC.125 & ORO.CC.130 Aircraft type specific training and operator conversion training & differences training

TRAINING PROGRAMMES

The programmes and syllabi of aircraft type specific training, operator conversion training and differences training should take into account the cabin crew member's previous training as documented in his/her training records.

AMC1 ORO.CC.125(b) & ORO.CC.130(c) Aircraft type specific training and operator conversion training & differences training

NON-MANDATORY (RECOMMENDATIONS) ELEMENTS OF OPERATIONAL SUITABILITY DATA

When developing the training programmes and syllabi for aircraft-type specific training and for differences training, the operator should consider the non-mandatory (recommendations) elements for the relevant type that are provided in the operational suitability data established in accordance with Commission Regulation (EU) No 748/2012¹⁹.

¹⁹ OJ L 243, 27.9.2003, p. 6.

ORO.CC.130 Differences training

- (a) In addition to the training required in ORO.CC.125, the cabin crew member shall complete appropriate training and checking covering any differences before being assigned on:
- (1) a variant of an aircraft type currently operated; or
 - (2) a currently operated aircraft type or variant with different:
 - (i) safety equipment;
 - (ii) safety and emergency equipment location; or
 - (iii) normal and emergency procedures.
- (b) The differences training programme shall:
- (1) be determined as necessary on the basis of a comparison with the training programme completed by the cabin crew member, in accordance with ORO.CC.125(c) and (d), for the relevant aircraft type; and
 - (2) involve training and practice in a representative training device or the actual aircraft as relevant to the difference training element to be covered.
- (c) When establishing a differences training programme and syllabus for a variant of an aircraft type currently operated, the operator shall include, where available, the relevant elements defined in the mandatory part of the operational suitability data established in accordance with Regulation (EU) No 748/2012.

AMC1 ORO.CC.125 & ORO.CC.130 Aircraft type specific training and operator conversion training & differences training**AMC1 ORO.CC.125(b) & ORO.CC.130(c) Aircraft type specific training and operator conversion training & differences training**

See [here](#).

ORO.CC.135 Familiarisation

After completion of aircraft type specific training and operator conversion training on an aircraft type, each cabin crew member shall complete appropriate supervised familiarisation on the type before being assigned to operate as a member of the minimum number of cabin crew required in accordance with ORO.CC.100.

AMC1 ORO.CC.135 Familiarisation

FAMILIARISATION FLIGHTS AND AIRCRAFT FAMILIARISATION VISITS

- (a) For CAT operations, familiarisation of cabin crew to a new aircraft type or variant should be completed in accordance with the following, as relevant:
- (1) New entrant cabin crew
Each new entrant cabin crew member having no previous comparable operating experience should participate in:
 - (i) a familiarisation visit, as described in (c), to the aircraft to be operated; and
 - (ii) familiarisation flights, as described in (b).
 - (2) Cabin crew operating on a subsequent aircraft type
A cabin crew member assigned to operate on a subsequent aircraft type with the same operator should participate either in:
 - (i) a familiarisation flight, as described in (b); or
 - (ii) a familiarisation visit, as described in (c), to the aircraft type to be operated.
- (b) Familiarisation flights
- (1) During familiarisation flights, the cabin crew member should be assigned in addition to the minimum number of cabin crew required in accordance with ORO.CC.100 and if applicable ORO.CC.200.
 - (2) Familiarisation flights should be:
 - (i) conducted under the supervision of the senior cabin crew member;
 - (ii) structured and conducted with the cabin crew member participating in pre-flight, in-flight and post-flight safety duties;
 - (iii) operated with the cabin crew member wearing the operator's cabin crew uniform; and
 - (iv) recorded in the training record of the cabin crew member.
- (c) Aircraft familiarisation visits
- (1) Aircraft visits should enable the cabin crew member to become familiar with the aircraft environment and its equipment. Accordingly, aircraft visits should be conducted by appropriately qualified persons. The aircraft visit should provide an overview of the aircraft's exterior, interior and aircraft systems with emphasis on the following:
 - (i) interphone and public address systems;
 - (ii) evacuation alarm systems;
 - (iii) emergency lighting;
 - (iv) smoke detection systems;

-
- (v) safety and emergency equipment;
 - (vi) flight crew compartment;
 - (vii) cabin crew stations;
 - (viii) lavatories;
 - (ix) galleys, galley security and water shut-off;
 - (x) cargo areas if accessible from the passenger compartment during flight;
 - (xi) circuit breaker panels located in the passenger compartment;
 - (xii) crew rest areas; and
 - (xiii) doors/exits location and environment.
- (2) An aircraft familiarisation visit may be combined with the aircraft type specific training or operator conversion training required by ORO.CC.125.
- (d) For cabin crew members assigned to operations other than CAT, familiarisation should be completed by means of an aircraft familiarisation visit, or a familiarisation flight, as appropriate taking into account the aircraft type to be operated by the cabin crew member.

ORO.CC.140 Recurrent training

- (a) Each cabin crew member shall complete annually recurrent training and checking.
- (b) Recurrent training shall cover the actions assigned to each member of the cabin crew in normal and emergency procedures and drills relevant to each aircraft type and/or variant to be operated.
- (c) Aircraft type specific training elements:
 - (1) Recurrent training shall include annually touch-drills by each cabin crew member for simulating the operation of each type or variant of normal and emergency doors and exits for passenger evacuation.
 - (2) Recurrent training shall also include at intervals not exceeding three years:
 - (i) operation and actual opening by each cabin crew member, in a representative training device or in the actual aircraft, of each type or variant of normal and emergency exits in the normal and emergency modes;
 - (ii) actual operation by each cabin crew member, in a representative training device or in the actual aircraft, of the flight crew compartment security door, in both normal and emergency modes, and of the seat and restraint system, and a practical demonstration of the oxygen system equipment relevant to pilot incapacitation;
 - (iii) demonstration of the operation of all other exits including the flight crew compartment windows; and
 - (iv) demonstration of the use of the life-raft, or slide raft, where fitted.
- (d) Operator specific training elements:
 - (1) Recurrent training shall include annually:
 - (i) by each cabin crew member:
 - (A) location and handling of all safety and emergency equipment installed or carried on board; and
 - (B) the donning of life-jackets, portable oxygen and protective breathing equipment (PBE);
 - (ii) stowage of articles in the passenger compartment;
 - (iii) procedures related to aircraft surface contamination;
 - (iv) emergency procedures;
 - (v) evacuation procedures;
 - (vi) incident and accident review;
 - (vii) crew resource management;
 - (viii) aero-medical aspects and first aid including related equipment;
 - (ix) security procedures.
 - (2) Recurrent training shall also include at intervals not exceeding three years:
 - (i) use of pyrotechnics (actual or representative devices);
 - (ii) practical demonstration of the use of flight crew checklists;

- (iii) realistic and practical training in the use of all fire-fighting equipment, including protective clothing, representative of that carried in the aircraft;
- (iv) by each cabin crew member:
 - (A) extinguishing a fire characteristic of an aircraft interior fire;
 - (B) donning and use of PBE in an enclosed simulated smoke-filled environment.
- (e) Validity periods:
 - (1) The annual recurrent training validity period shall be 12 calendar months counted from the end of the month when the check was taken.
 - (2) If the recurrent training and checking required in (a) are undertaken within the last three calendar months of the validity period, the new validity period shall be counted from the original expiry date.
 - (3) For the additional triennial training elements specified in (c)(2) and (d)(2), the validity period shall be 36 calendar months counted from the end of the month when the checks were taken.

AMC1 ORO.CC.140 Recurrent training

TRAINING PROGRAMMES

- (a) Elements of the annual recurrent training programme
 - (1) Training on the location and handling of safety and emergency equipment should include all relevant oxygen systems, and any equipment such as defibrillators if carried on board.
 - (2) Training on emergency procedures should cover pilot incapacitation procedures and crowd control techniques.
 - (3) CRM training should satisfy the following:
 - (i) the applicable training elements specified in Table 1 of AMC1 ORO.CC.115(e) should be covered within a 3-year cycle to the level required by column 'Annual Recurrent Training';
 - (ii) the definition and implementation of the CRM training programme should be managed by a cabin crew CRM trainer; and
 - (iii) when CRM training is provided by stand-alone modules, it should be conducted by at least one cabin crew CRM trainer.
- (b) Additional triennial elements of recurrent training programme
 - (1) Training on the operation of normal and emergency doors/exits should cover failure of power assist systems where fitted. This should include the actions and forces required to operate and deploy evacuation slides, and additional training when relevant for cabin crew members responsible for a pair of doors/exits.
 - (2) Training in the use of all firefighting equipment, including protective clothing, representative of that carried in the aircraft should include individual practice by each cabin crew member to extinguish a fire characteristic of an aircraft interior fire except that, in the case of halon extinguishers, an alternative extinguishing agent may be used. Training should place particular emphasis on identifying the actual source of fire or smoke.
 - (3) Training on normal and emergency procedures for special categories of passengers (SCPs) should cover the specific procedures established by the operator for the carriage of SCPs.

The operator may determine that such training is to be completed at shorter intervals, taking into account the route structure, passenger profiles, aircraft types operated, seasonal demands and operations.

ORO.CC.145 Refresher training

- (a) When a cabin crew member, during the preceding six months within the validity period of the last relevant recurrent training and checking:
- (1) has not performed any flying duties, he/she shall, before being reassigned to such duties, complete refresher training and checking for each aircraft type to be operated; or
 - (2) has not performed flying duties on one particular aircraft type, he/she shall, before being reassigned to duties, complete on that aircraft type:
 - (i) refresher training and checking; or
 - (ii) two familiarisation flights in accordance with ORO.CC.135.
- (b) The refresher training programme for each aircraft type shall at least cover:
- (1) emergency procedures;
 - (2) evacuation procedures;
 - (3) operation and actual opening, by each cabin crew member, of each type or variant of normal and emergency exits and of the flight crew compartment security door in the normal and emergency modes;
 - (4) demonstration of the operation of all other exits including the flight crew compartment windows;
 - (5) location and handling of all relevant safety and emergency equipment installed or carried on-board.
- (c) The operator may elect to replace refresher training by recurrent training if the reinstatement of the cabin crew member's flying duties commences within the validity period of the last recurrent training and checking. If that validity period has expired, refresher training may only be replaced by aircraft type specific and operator conversion training as specified in ORO.CC.125.

AMC1 ORO.CC.145 Refresher training

TRAINING PROGRAMME

- (a) Training on emergency procedures should include pilot incapacitation procedures and crowd control techniques as applicable to the aircraft type; and
- (b) Operation of doors and exits by each cabin crew member should include failure of power assist systems where fitted as well as the action and forces required to operate and deploy evacuation slides.

GM1 ORO.CC.145 Refresher training

FREQUENCY OF REFRESHER TRAINING

For aircraft with complex equipment or procedures, the operator should consider the need for refresher training to be completed by cabin crew members who have been absent from flying duties for less than 6 months.

SECTION 2
Additional requirements for commercial air transport operations

ORO.CC.200 Senior cabin crew member

- (a) When more than one cabin crew member is required, the composition of the cabin crew shall include a senior cabin crew member nominated by the operator.
- (b) The operator shall nominate cabin crew members to the position of senior cabin crew member only if they:
 - (1) have at least one year of experience as operating cabin crew member; and
 - (2) have successfully completed a senior cabin crew training course and the associated check.
- (c) The senior cabin crew training course shall cover all duties and responsibilities of senior cabin crew members and shall include at least the following elements:
 - (1) pre-flight briefing;
 - (2) cooperation with the crew;
 - (3) review of operator requirements and legal requirements;
 - (4) accident and incident reporting;
 - (5) human factors and crew resource management (CRM); and
 - (6) flight and duty time limitations and rest requirements.
- (d) The senior cabin crew member shall be responsible to the commander for the conduct and coordination of normal and emergency procedures specified in the operations manual, including for discontinuing non-safety-related duties for safety or security purposes.
- (e) The operator shall establish procedures to select the most appropriately qualified cabin crew member to act as senior cabin crew member if the nominated senior cabin crew member becomes unable to operate. Changes to these procedures shall be notified to the competent authority.

AMC1 ORO.CC.200(c) Senior cabin crew member**TRAINING PROGRAMME**

The senior cabin crew member training course should at least cover the following elements:

- (a) Pre-flight briefing:
 - (1) operating as a crew;
 - (2) allocation of cabin crew stations and responsibilities; and
 - (3) consideration of the particular flight, aircraft type, equipment, area and type of operation, including extended range operations with two-engine aeroplanes (ETOPS) and special categories of passengers with emphasis on passengers with disabilities or reduced mobility, infants and stretcher cases.
- (b) Cooperation within the crew:
 - (1) discipline, responsibilities and chain of command;
 - (2) importance of coordination and communication; and

- (3) pilot incapacitation.
- (c) Review of operator requirements and legal requirements:
 - (1) passenger briefing, safety briefing cards;
 - (2) securing of galleys;
 - (3) stowage of cabin baggage;
 - (4) electronic equipment;
 - (5) procedures when fuelling with passengers on board;
 - (6) turbulence; and
 - (7) documentation.
- (d) Accident and incident reporting.
- (e) Human factors and CRM:

The operator should ensure that all applicable elements specified in Table 1 of AMC1 ORO.CC.115(e) are integrated into the training and covered to the level required by Column 'Senior Cabin Crew Course'.
- (f) Flight and duty time limitations and rest requirements (FTL).

AMC1 ORO.CC.200(d) Senior cabin crew member

RESPONSIBILITY TO THE COMMANDER

When the level of turbulence so requires, and in the absence of any instructions from the flight crew, the senior cabin crew member should be entitled to discontinue non-safety-related duties and advise the flight crew of the level of turbulence being experienced and the need for the fasten seat belt signs to be switched on. This should be followed by the cabin crew securing the passenger cabin and other relevant areas.

AMC1 ORO.CC.200(e) Senior cabin crew member

UNABLE TO OPERATE

- (a) Replacement of senior cabin crew member at a base of the operator

A senior cabin crew member who did not report for or cannot commence the assigned flight or series of flights originating from a base of the operator should be replaced without undue delay. The flight should not depart unless another senior cabin crew member has been assigned.
- (b) Replacement of incapacitated or unavailable senior cabin crew member
 - (1) A senior cabin crew member, who becomes incapacitated during a flight or series of flights, or unavailable at a stopover (layover) point, should be replaced without undue delay by another senior cabin crew member qualified on the concerned aircraft type/variant. If there is no other senior cabin crew member, the most appropriately qualified cabin crew member should be assigned to act as senior cabin crew member in order to reach a base of the operator.
 - (2) If during the series of flights the aircraft transits via a base of the operator, the assigned cabin crew member acting as senior cabin crew member should be replaced by another senior cabin crew member.

AMC2 ORO.CC.200(e) Senior cabin crew member

MOST APPROPRIATELY QUALIFIED CABIN CREW MEMBER

Selection of the most appropriately qualified cabin crew member should take into account if the individual's experience as operating cabin crew member is adequate for the conduct of duties required of a senior cabin crew member. The selected cabin crew member should have operational experience on the concerned aircraft type/variant.

GM1 ORO.CC.200(e) Senior cabin crew member

REPLACEMENT OF INCAPACITATED OR UNAVAILABLE SENIOR CABIN CREW MEMBER BY ANOTHER SENIOR CABIN CREW MEMBER

To ensure that another senior cabin crew member is assigned without undue delay, the operator should take appropriate measures. These include, but are not limited to, the following:

- (a) to ensure that a flight or series of flights do not depart from an aerodrome where a senior cabin crew member is available or can be made available, the operator may:
 - (1) appoint a senior cabin crew member originally assigned to another flight and who is available at the concerned base or stopover (layover) point if the reporting time for that flight provides sufficient time to find a replacement; or
 - (2) assign a senior cabin crew member who is on standby to operate the flight or to position to the destination where the nominated senior cabin crew member has become incapacitated or unavailable to operate;
- (b) the operator should utilise another senior cabin crew member if she/he is among the operating crew on the same flight;
- (c) in case of unavailable senior cabin crew member, the operator should use the available time and resources to replace him/her at the stopover (layover) point with another senior cabin crew member;
- (d) the operator should consider including the identification of the most appropriately qualified cabin crew member in pre-flight briefings.

GM2 ORO.CC.200(e) Senior cabin crew member

FLIGHT OR SERIES OF FLIGHTS

Flight or series of flights refers to a period that commences when a cabin crew member is required to report for duty, which includes a sector or a series of sectors, and finishes when the aircraft finally comes to rest and the engines are shut down, at the end of the last sector on which the cabin crew member acts as an operating crew member.

ORO.CC.205 Reduction of the number of cabin crew during ground operations and in unforeseen circumstances

- (a) Whenever any passengers are on board an aircraft, the minimum number of cabin crew required in accordance with ORO.CC.100 shall be present in the passenger compartment.
- (b) Subject to the conditions specified in (c), this number may be reduced:
- (1) during normal ground operations not involving refuelling/defuelling when the aircraft is at its parking station; or
 - (2) in unforeseen circumstances if the number of passengers carried on the flight is reduced. In this case a report shall be submitted to the competent authority after completion of the flight.
- (c) Conditions:
- (1) procedures ensuring that an equivalent level of safety is achieved with the reduced number of cabin crew, in particular for evacuation of passengers, are established in the operations manual;
 - (2) the reduced cabin crew includes a senior cabin crew member as specified in ORO.CC. 200;
 - (3) at least one cabin crew member is required for every 50, or fraction of 50, passengers present on the same deck of the aircraft;
 - (4) in the case of normal ground operations with aircraft requiring more than one cabin crew member, the number determined in accordance with (c)(3) shall be increased to include one cabin crew member per pair of floor level emergency exits.

GM1 ORO.CC.205(b)(2) Reduction of the number of cabin crew during ground operations and in unforeseen circumstances**UNFORESEEN CIRCUMSTANCES**

Unforeseen circumstances in this context refer to incapacitation and unavailability of a senior cabin crew member or a cabin crew member as follows:

- (a) ‘Incapacitation’ means a sudden degradation of medical fitness that occurs during flight duty period either in-flight or during a flight transit of the same flight duty period away from operator’s base and that precludes the senior cabin crew member or cabin crew member from performing his/her duties. Incapacitation prior to dispatch of the aircraft from a base of the operator does not substantiate a reduction of the cabin crew complement below the minimum required.
- (b) ‘Unavailability’ means circumstances at a stopover (layover) destination that preclude the senior cabin crew member or cabin crew member from reporting for the flight duty period, such as traffic jams that prevent the senior cabin crew member or cabin crew member from presenting himself/herself at the crew pick-up point in time, difficulties with local authorities, health problems, death, etc. Unavailability does not refer to insufficient number or absence of cabin crew members on standby, or absence from work due to pregnancy, maternity/paternity leave, parental leave, medical leave, sick leave, or any other absence from work.

AMC1 ORO.CC.205(c)(1) Reduction of the number of cabin crew during ground operations and in unforeseen circumstances

PROCEDURES WITH REDUCED NUMBER OF CABIN CREW

- (a) During ground operations, if reducing the applicable minimum required number of cabin crew, the operator should ensure that the procedures required by ORO.CC.205 (c)(1) specify that:
- (1) electrical power is available on the aircraft;
 - (2) a means of initiating an evacuation is available to the senior cabin crew member or at least one member of the flight crew is in the flight crew compartment;
 - (3) cabin crew stations and associated duties are specified in the operations manual; and
 - (4) cabin crew remain aware of the position of servicing and loading vehicles at and near the exits.
- Additionally, in the case of passengers' embarkation:
- (5) the senior cabin crew member should have performed the pre-boarding safety briefing to the cabin crew; and
 - (6) the pre-boarding cabin checks should have been completed.
- (b) If, in unforeseen circumstances, the number of cabin crew members is reduced below the applicable minimum required number, for example in the event of incapacitation or unavailability of cabin crew, the procedures established for this purpose in the operations manual should take into consideration at least the following:
- (1) reduction of passenger numbers;
 - (2) reseating of passengers with due regard to doors/exits and other applicable limitations; and
 - (3) relocation of cabin crew taking into account the factors specified in AMC1 ORO.CC.100 and any change of procedures.

ORO.CC.210 Additional conditions for assignment to duties

Cabin crew members shall only be assigned to duties, and operate, on a particular aircraft type or variant if they:

- (a) hold a valid attestation issued in accordance with Annex V (Part-CC) to Regulation (EU) No 1178/2011;
- (b) are qualified on the type or variant in accordance with this Subpart;
- (c) comply with the other applicable requirements of this Subpart and Annex IV (Part-CAT);
- (d) wear the operator's cabin crew uniform.

GM1 ORO.CC.210(d) Additional conditions for assignment to duties**OPERATOR'S CABIN CREW UNIFORM**

The uniform to be worn by operating cabin crew should be such as not to impede the performance of their duties, as required for the safety of passengers and flight during operations, and should allow passengers to identify the operating cabin crew including in an emergency situation.

ORO.CC.215 Training and checking programs and related documentation

- (a) Training and checking programmes including syllabi required by this Subpart shall be approved by the competent authority and specified in the operations manual.
- (b) After a cabin crew member has successfully completed a training course and the associated check, the operator shall:
 - (1) update the cabin crew member's training records in accordance with ORO.MLR.115; and
 - (2) provide him/her with a list showing updated validity periods as relevant to the aircraft type(s) and variant(s) on which the cabin crew member is qualified to operate.

GM1 ORO.CC.215(b)(2) Training and checking programmes and related documentation

LIST OF AIRCRAFT TYPE/VARIANT QUALIFICATION(S)

When providing the updated validity list of aircraft type/variant qualifications to cabin crew members having successfully completed a training course and the associated checking, the operator may use the following format. If using another format, at least the elements in (a) to (d) and in columns (1) and (2) should be indicated to show validity of qualification(s).

CABIN CREW AIRCRAFT TYPE/VARIANT QUALIFICATION(S)							
(a)	Reference number of the cabin crew attestation:						
(b)	Cabin crew attestation holder’s full name: The above-mentioned person may act as an operating cabin crew member during flight operations only if his/her aircraft type and/or variant qualification(s) listed below, and dated DD/MM/YYYY, comply with the applicable validity period(s) specified in Part-ORO.						
(c)	Issuing organisation: (name, postal address, AOC and/or approval reference number and stamp or logo)						
(d)	Date of issue: (DD/MM/YYYY)						
(1)	(2)	(3)	(4)	(5)	(6)	(7)	(8)
	Qualification valid until	Aircraft type specific training	Operator conversion training	Differences training <i>If relevant</i>	Familiarisation	Last recurrent training	Refresher training <i>If relevant</i>
A/C type 1							
Variant ...							
A/C type 2							
Variant ...							
A/C type 3							
Variant ...							
<i>If approved</i> A/C type 4							

ORO.CC.250 Operation on more than one aircraft type or variant

- (a) A cabin crew member shall not be assigned to operate on more than three aircraft types, except that, with the approval of the competent authority, the cabin crew member may be assigned to operate on four aircraft types if for at least two of the types:
- (1) safety and emergency equipment and type-specific normal and emergency procedures are similar; and
 - (2) non-type-specific normal and emergency procedures are identical.
- (b) For the purpose of (a) and for cabin crew training and qualifications, the operator shall determine:
- (1) each aircraft as a type or a variant taking into account, where available, the relevant elements defined in the mandatory part of the operational suitability data established in accordance with Regulation (EU) No 748/2012 for the relevant aircraft type or variant; and
 - (2) variants of an aircraft type to be different types if they are not similar in the following aspects:
 - (i) emergency exit operation;
 - (ii) location and type of portable safety and emergency equipment;
 - (iii) type-specific emergency procedures.

AMC1 ORO.CC.250(b) Operation on more than one aircraft type or variant

DETERMINATION OF AIRCRAFT TYPES AND VARIANTS

- (a) When determining similarity of location and type of portable safety and emergency equipment, the following factors should be assessed:
- (1) all portable safety and emergency equipment is stowed in the same, or in exceptional circumstances, in substantially the same location;
 - (2) all portable safety and emergency equipment requires the same method of operation;
 - (3) portable safety and emergency equipment includes:
 - (i) fire-fighting equipment;
 - (ii) protective breathing equipment (PBE);
 - (iii) oxygen equipment;
 - (iv) crew life-jackets;
 - (v) torches;
 - (vi) megaphones;
 - (vii) first-aid equipment;
 - (viii) survival and signalling equipment; and
 - (ix) other safety and emergency equipment, where applicable.
- (b) The type-specific emergency procedures to be considered should include at least the following:
- (1) land and water evacuation;
 - (2) in-flight fire;

-
- (3) non-pressurisation, slow and sudden decompression; and
 - (4) pilot incapacitation.
- (c) When determining similarity of doors/exits in the absence of operational suitability data established in accordance with Commission Regulation (EU) No 748/2012 for the relevant aircraft type(s) or variant(s), the following factors should be assessed, except for self-help exits, such as type III and type IV exits, that need not be included in the assessment:
- (1) door/exit arming and disarming;
 - (2) direction of movement of the operating handle;
 - (3) direction of door/exit opening;
 - (4) power assist mechanisms; and
 - (5) assisting evacuation means.

GM1 ORO.CC.250 Operation on more than one aircraft type or variant

SAFETY BRIEFING FOR CABIN CREW

When changing aircraft type or variant during a series of flight sectors, the cabin crew safety briefing should include a representative sample of type-specific normal and emergency procedures and safety and emergency equipment applicable to the actual aircraft to be operated for the immediately subsequent flight sector.

ORO.CC.255 Single cabin crew member operations

- (a) The operator shall select, recruit, train and check the proficiency of cabin crew members to be assigned to single cabin crew member operations according to criteria appropriate to this type of operation.
- (b) Cabin crew members who have no previous operating experience as single cabin crew member shall only be assigned to such type of operation after they have:
 - (1) completed training as required in (c) in addition to other applicable training and checking required by this Subpart;
 - (2) successfully passed the checks verifying their proficiency in discharging their duties and responsibilities in accordance with the procedures specified in the operations manual; and
 - (3) undertaken familiarisation flying of at least 20 hours and 15 sectors on the relevant aircraft type under the supervision of an appropriately experienced cabin crew member.
- (c) The following additional training elements shall be covered with particular emphasis to reflect single cabin crew operations:
 - (1) responsibility to the commander for the conduct of normal and emergency procedures;
 - (2) importance of coordination and communication with the flight crew, in particular when managing unruly or disruptive passengers;
 - (3) review of operator requirements and legal requirements;
 - (4) documentation;
 - (5) accident and incident reporting; and
 - (6) flight and duty time limitations and rest requirements.

SUBPART TC: TECHNICAL CREW IN HEMS, HHO OR NVIS OPERATIONS

ORO.TC.100 Scope

This Subpart establishes the requirements to be met by the operator when operating an aircraft with technical crew members in commercial air transport helicopter emergency medical service (HEMS), night vision imaging system (NVIS) operations or helicopter hoist operations (HHO).

ORO.TC.105 Conditions for assignment to duties

- (a) Technical crew members in commercial air transport HEMS, HHO or NVIS operations shall only be assigned duties if they:
 - (1) are at least 18 years of age;
 - (2) are physically and mentally fit to safely discharge assigned duties and responsibilities;
 - (3) have completed all applicable training required by this Subpart to perform the assigned duties;
 - (4) have been checked as proficient to perform all assigned duties in accordance with the procedures specified in the operations manual.
- (b) Before assigning to duties technical crew members who are self-employed and/or working on a freelance or part-time basis, the operator shall verify that all applicable requirements of this Subpart are complied with, taking into account all services rendered by the technical crew member to other operator(s) to determine in particular:
 - (1) the total number of aircraft types and variants operated;
 - (2) the applicable flight and duty time limitations and rest requirements.

GM1 ORO.TC.105 Conditions for assignment to duties

GENERAL

- (a) The technical crew member in HEMS, HHO or NVIS operations should undergo an initial medical examination or assessment and, if applicable, a re-assessment before undertaking duties.
- (b) Any medical assessment or re-assessment should be carried out according to best aero-medical practice by a medical practitioner who has sufficiently detailed knowledge of the applicant's medical history.
- (c) The operator should maintain a record of medical fitness for each technical crew member.
- (d) Technical crew members should:
 - (1) be in good health;
 - (2) be free from any physical or mental illness that might lead to incapacitation or inability to perform crew duties;
 - (3) have normal cardio-respiratory function;
 - (4) have normal central nervous system;
 - (5) have adequate visual acuity 6/9 with or without glasses;

- (6) have adequate hearing; and
- (7) have normal function of ear, nose and throat.

ORO.TC.110 Training and checking

- (a) The operator shall establish a training programme in accordance with the applicable requirements of this Subpart to cover the duties and responsibilities to be performed by technical crew members.
- (b) Following the completion of initial, operator conversion, differences and recurrent training, each technical crew member shall undergo a check to demonstrate their proficiency in carrying out normal and emergency procedures.
- (c) Training and checking shall be conducted for each training course by personnel suitably qualified and experienced in the subject to be covered. The operator shall inform the competent authority about the personnel conducting the checks.

AMC1 ORO.TC.110 Training and checking

GENERAL

- (a) Elements of training that require individual practice may be combined with practical checks.
- (b) The checks should be accomplished by the method appropriate to the type of training including:
 - (1) practical demonstration;
 - (2) computer-based assessment;
 - (3) in-flight checks; and/or
 - (4) oral or written tests.

AMC1 ORO.TC.110(a) Training and checking

CRM TRAINING

The technical crew training programme for initial, operator conversion and recurrent training should include relevant CRM training elements as specified in AMC1 ORO.FC.115.

ORO.TC.115 Initial training

Before undertaking the operator conversion training, each technical crew member shall complete initial training, including:

- (a) general theoretical knowledge on aviation and aviation regulations covering all elements relevant to the duties and responsibilities required of technical crew;
- (b) fire and smoke training;
- (c) survival training on ground and in water, appropriate to the type and area of operation;
- (d) aero-medical aspects and first-aid;
- (e) communication and relevant CRM elements of ORO.FC.115 and ORO.FC.215.

AMC1 ORO.TC.115 Initial training**ELEMENTS**

- (a) The elements of initial training mentioned in ORO.TC.115 should include in particular:
 - (1) General theoretical knowledge on aviation and aviation regulations relevant to duties and responsibilities:
 - (i) the importance of crew members performing their duties in accordance with the operations manual;
 - (ii) continuing competence and fitness to operate as a crew member with special regard to flight and duty time limitations and rest requirements;
 - (iii) an awareness of the aviation regulations relating to crew members and the role of the competent and inspecting authority;
 - (iv) general knowledge of relevant aviation terminology, theory of flight, passenger distribution, meteorology and areas of operation;
 - (v) pre-flight briefing of the crew members and the provision of necessary safety information with regard to their specific duties;
 - (vi) the importance of ensuring that relevant documents and manuals are kept up-to-date with amendments provided by the operator;
 - (vii) the importance of identifying when crew members have the authority and responsibility to initiate an evacuation and other emergency procedures; and
 - (viii) the importance of safety duties and responsibilities and the need to respond promptly and effectively to emergency situations.
 - (2) Fire and smoke training:
 - (i) reactions to emergencies involving fire and smoke and identification of the fire sources;
 - (ii) the classification of fires and the appropriate type and techniques of application of extinguishing agents, the consequences of misapplication, and of use in a confined space; and
 - (iii) the general procedures of ground-based emergency services at aerodromes.
 - (3) When conducting extended overwater operations, water survival training, including the use of personal flotation equipment.

-
- (4) Before first operating on an aircraft fitted with life-rafts or other similar equipment, training on the use of this equipment, including practice in water.
 - (5) Survival training appropriate to the areas of operation (e.g. polar, desert, jungle, sea or mountain).
 - (6) Aero-medical aspects and first aid, including:
 - (i) instruction on first aid and the use of first-aid kits; and
 - (ii) the physiological effects of flying.
 - (7) Effective communication between technical crew members and flight crew members, including common language and terminology.

ORO.TC.120 Operator conversion training

Each technical crew member shall complete:

- (a) operator conversion training, including relevant CRM elements,
 - (1) before being first assigned by the operator as a technical crew member; or
 - (2) when changing to a different aircraft type or class, if any of the equipment or procedures mentioned in (b) are different.
- (b) Operator conversion training shall include:
 - (1) the location and use of all safety and survival equipment carried on the aircraft;
 - (2) all normal and emergency procedures;
 - (3) on-board equipment used to carry out duties in the aircraft or on the ground for the purpose of assisting the pilot during HEMS, HHO or NVIS operations.

AMC1 ORO.TC.120&.125 Operator conversion training and differences training**ELEMENTS**

- (a) Operator conversion training mentioned in ORO.TC.120 (b) and differences training mentioned in ORO.TC.125 (a) should include the following:
 - (1) Fire and smoke training, including practical training in the use of all fire fighting equipment as well as protective clothing representative of that carried in the aircraft. Each technical crew member should:
 - (i) extinguish a fire characteristic of an aircraft interior fire except that, in the case of Halon extinguishers, an alternative extinguishing agent may be used; and
 - (ii) practise the donning and use of protective breathing equipment (when fitted) in an enclosed, simulated smoke-filled environment.
 - (2) Practical training on operating and opening all normal and emergency exits for passenger evacuation in an aircraft or representative training device and demonstration of the operation of all other exits.
 - (3) Evacuation procedures and other emergency situations, including:
 - (i) recognition of planned or unplanned evacuations on land or water — this training should include recognition of unusable exits or unserviceable evacuation equipment;
 - (ii) in-flight fire and identification of fire source; and
 - (iii) other in-flight emergencies.
 - (4) When the flight crew is more than one, training on assisting if a pilot becomes incapacitated, including a demonstration of:
 - (i) the pilot's seat mechanism;
 - (ii) fastening and unfastening the pilot's seat restraint system;
 - (iii) use of the pilot's oxygen equipment, when applicable; and
 - (iv) use of pilots' checklists.
 - (5) Training on, and demonstration of, the location and use of safety equipment, including the following:

- (i) life rafts, including the equipment attached to, and/or carried in, the raft, where applicable;
 - (ii) life jackets, infant life jackets and flotation devices, where applicable;
 - (iii) fire extinguishers;
 - (iv) crash axe or crow bar;
 - (v) emergency lights, including portable lights;
 - (vi) communication equipment, including megaphones;
 - (vii) survival packs, including their contents;
 - (viii) pyrotechnics (actual or representative devices);
 - (ix) first-aid kits, their contents and emergency medical equipment; and
 - (x) other safety equipment or systems, where applicable.
- (6) Training on passenger briefing/safety demonstrations and preparation of passengers for normal and emergency situations.
- (7) Training on the use of dangerous goods, if applicable.
- (8) Task-specific training.

AMC2 ORO.TC.120&.125 Operator conversion training and differences training

GENERAL

- (a) The operator should determine the content of the conversion or differences training taking account of the technical crew member's previous training as documented in the technical crew member's training records.
- (b) Aircraft conversion or differences training should be conducted according to a syllabus and include the use of relevant equipment and emergency procedures and practice on a representative training device or on the actual aircraft.
- (c) The operator should specify in the operations manual the maximum number of types or variants that can be operated by a technical crew member.

ORO.TC.125 Differences training

- (a) Each technical crew member shall complete differences training when changing equipment or procedures on types or variants currently operated.
- (b) The operator shall specify in the operations manual when such differences training is required.

ORO.TC.130 Familiarisation flights

Following completion of the operator conversion training, each technical crew member shall undertake familiarisation flights prior to operating as a required technical crew member in HEMS, HHO or NVIS operations.

ORO.TC.135 Recurrent training

- (a) Within every 12-month period, each technical crew member shall undergo recurrent training relevant to the type or class of aircraft and equipment that the technical crew member operates. Elements of CRM shall be integrated into all appropriate phases of the recurrent training.
- (b) Recurrent training shall include theoretical and practical instruction and practice.

AMC1 ORO.TC.135 Recurrent training**ELEMENTS**

- (a) The 12-month period mentioned in ORO.TC.135 (a) should be counted from the last day of the month when the first checking was made. Further training and checking should be undertaken within the last 3 calendar months of that period. The new 12-month period should be counted from the original expiry date.
- (b) The recurrent practical training should include every year:
 - (1) emergency procedures, including pilot incapacitation;
 - (2) evacuation procedures;
 - (3) touch-drills by each technical crew member for opening normal and emergency exits for (passenger) evacuation;
 - (4) the location and handling of emergency equipment and the donning by each technical crew member of life jackets and protective breathing equipment (PBE), when applicable;
 - (5) first aid and the contents of the first-aid kit(s);
 - (6) stowage of articles in the cabin;
 - (7) use of dangerous goods, if applicable;
 - (8) incident and accident review; and
 - (9) crew resource management: all major topics of the initial CRM training should be covered over a period not exceeding 3 years.
- (c) Recurrent training should include every 3 years:
 - (1) practical training on operating and opening all normal and emergency exits for passenger evacuation in an aircraft or representative training device and demonstration of the operation of all other exits;
 - (2) practical training in the use of all firefighting equipment as well as protective clothing representative of that carried in the aircraft. Each technical crew member should:

-
- (i) extinguish a fire characteristic of an aircraft interior fire except that, in the case of Halon extinguishers, an alternative extinguishing agent may be used; and
 - (ii) practise the donning and use of protective breathing equipment (when fitted) in an enclosed, simulated smoke-filled environment;
- (3) use of pyrotechnics (actual or representative devices); and
 - (4) demonstration of the use of the life raft, where fitted.

ORO.TC.140 Refresher training

- (a) Each technical crew member who has not undertaken duties in the previous six months shall complete the refresher training specified in the operations manual.
- (b) The technical crew member who has not performed flying duties on one particular aircraft type or class during the preceding six months shall, before being assigned on that type or class, complete either:
 - (1) refresher training on the type or class; or
 - (2) two familiarisation sectors on the aircraft type or class.

AMC1 ORO.TC.140 Refresher training

ELEMENTS

- (a) Refresher training may include familiarisation flights.
- (b) Refresher training should include at least the following:
 - (1) emergency procedures, including pilot incapacitation;
 - (2) evacuation procedures;
 - (3) practical training on operating and opening all normal and emergency exits for passenger evacuation in an aircraft or representative training device and demonstration of the operation of all other exits; and
 - (4) the location and handling of emergency equipment, and the donning of life jackets and protective breathing equipment, when applicable.

SUBPART FTL: FLIGHT AND DUTY TIME LIMITATIONS AND REST REQUIREMENTS

SECTION 1 General

ORO.FTL.100 Scope

This Subpart establishes the requirements to be met by an operator and its crew members with regard to flight and duty time limitations and rest requirements for crew members.

ORO.FTL.105 Definitions

For the purpose of this Subpart, the following definitions shall apply:

- (1) ‘acclimatised’ means a state in which a crew member’s circadian biological clock is synchronised to the time zone where the crew member is. A crew member is considered to be acclimatised to a 2-hour wide time zone surrounding the local time at the point of departure. When the local time at the place where a duty commences differs by more than 2 hours from the local time at the place where the next duty starts, the crew member, for the calculation of the maximum daily flight duty period, is considered to be acclimatised in accordance with the values in the Table 1.

Table 1

Time difference (h) between reference time and local time where the crew member starts the next duty	Time elapsed since reporting at reference time				
	<48	48–71:59	72–95:59	96–119:59	≥120
< 4	B	D	D	D	D
≤6	B	X	D	D	D
≤9	B	X	X	D	D
≤12	B	X	X	X	D

‘B’ means acclimatised to the local time of the departure time zone,

‘D’ means acclimatised to the local time where the crew member starts his/her next duty, and

‘X’ means that a crew member is in an unknown state of acclimatisation.

- (2) ‘reference time’ means the local time at the reporting point situated in a 2-hour wide time zone band around the local time where a crew member is acclimatised;
- (3) ‘accommodation’ means, for the purpose of standby and split duty, a quiet and comfortable place not open to the public with the ability to control light and temperature, equipped with adequate furniture that provides a crew member with the possibility to sleep, with enough capacity to accommodate all crew members present at the same time and with access to food and drink;
- (4) ‘suitable accommodation’ means, for the purpose of standby, split duty and rest, a separate room for each crew member located in a quiet environment and equipped with a bed, which is

- sufficiently ventilated, has a device for regulating temperature and light intensity, and access to food and drink;
- (5) ‘augmented flight crew’ means a flight crew which comprises more than the minimum number required to operate the aircraft, allowing each flight crew member to leave the assigned post, for the purpose of in-flight rest, and to be replaced by another appropriately qualified flight crew member;
- (6) ‘break’ means a period of time within an flight duty period, shorter than a rest period, counting as duty and during which a crew member is free of all tasks;
- (7) ‘delayed reporting’ means the postponement of a scheduled FDP by the operator before a crew member has left the place of rest;
- (8) ‘disruptive schedule’ means a crew member’s roster which disrupts the sleep opportunity during the optimal sleep time window by comprising an FDP or a combination of FDPs which encroach, start or finish during any portion of the day or of the night where a crew member is acclimatised. A schedule may be disruptive due to early starts, late finishes or night duties.
- (a) ‘early type’ of disruptive schedule means:
- (i) for ‘early start’ a duty period starting in the period between 05:00 and 05:59 in the time zone to which a crew member is acclimatised, and
 - (ii) for ‘late finish’ a duty period finishing in the period between 23:00 and 01:59 in the time zone to which a crew member is acclimatised;
- (b) ‘late type’ of disruptive schedule means:
- (i) for ‘early start’ a duty period starting in the period between 05:00 and 06:59 in the time zone to which a crew member is acclimatised; and
 - (ii) for ‘late finish’ a duty period finishing in the period between 00:00 and 01:59 in the time zone to which a crew member is acclimatised;
- (9) ‘night duty’ means a duty period encroaching any portion of the period between 02:00 and 04:59 in the time zone to which the crew is acclimatised;
- (10) ‘duty’ means any task that a crew member performs for the operator, including flight duty, administrative work, giving or receiving training and checking, positioning, and some elements of standby;
- (11) ‘duty period’ means a period which starts when a crew member is required by an operator to report for or to commence a duty and ends when that person is free of all duties, including post-flight duty;
- (12) ‘flight duty period (‘FDP’)' means a period that commences when a crew member is required to report for duty, which includes a sector or a series of sectors, and finishes when the aircraft finally comes to rest and the engines are shut down, at the end of the last sector on which the crew member acts as an operating crew member;
- (13) ‘flight time’ means, for aeroplanes and touring motor gliders, the time between an aircraft first moving from its parking place for the purpose of taking off until it comes to rest on the designated parking position and all engines or propellers are shut down.
- (14) ‘home base’ means the location, assigned by the operator to the crew member, from where the crew member normally starts and ends a duty period or a series of duty periods and where, under normal circumstances, the operator is not responsible for the accommodation of the crew member concerned;

- (15) 'local day' means a 24-hour period commencing at 00:00 local time;
- (16) 'local night' means a period of 8 hours falling between 22:00 and 08:00 local time;
- (17) 'operating crew member' means a crew member carrying out duties in an aircraft during a sector;
- (18) 'positioning' means the transferring of a non-operating crew member from one place to another, at the behest of the operator, excluding:
- the time of travel from a private place of rest to the designated reporting place at home base and vice versa, and
 - the time for local transfer from a place of rest to the commencement of duty and vice versa;
- (19) 'rest facility' means a bunk or seat with leg and foot support suitable for crew members' sleeping on board an aircraft.
- (20) 'reserve' means a period of time during which a crew member is required by the operator to be available to receive an assignment for an FDP, positioning or other duty notified at least 10 hours in advance.
- (21) 'rest period' means a continuous, uninterrupted and defined period of time, following duty or prior to duty, during which a crew member is free of all duties, standby and reserve.
- (22) 'rotation' is a duty or a series of duties, including at least one flight duty, and rest periods out of home base, starting at home base and ending when returning to home base for a rest period where the operator is no longer responsible for the accommodation of the crew member.
- (23) 'single day free of duty' means, for the purpose of complying with the provisions of Council Directive 2000/79/EC, a time free of all duties and standby consisting of one day and two local nights, which is notified in advance. A rest period may be included as part of the single day free of duty.
- (24) 'sector' means the segment of an FDP between an aircraft first moving for the purpose of taking off until it comes to rest after landing on the designated parking position.
- (25) 'standby' means a pre-notified and defined period of time during which a crew member is required by the operator to be available to receive an assignment for a flight, positioning or other duty without an intervening rest period.
- (26) 'airport standby' means a standby performed at the airport;
- (27) 'other standby' means a standby either at home or in a suitable accommodation;
- (28) 'window of circadian low ('WOCL') means the period between 02:00 and 05:59 hours in the time zone to which a crew member is acclimatised.

GM1 ORO.FTL.105(1) Definitions

ACCLIMATISED

- (a) A crew member remains acclimatised to the local time of his/her reference time during 47 hours 59 minutes after reporting no matter how many time zones he/she has crossed.
- (b) The maximum daily FDP for acclimatised crew members is determined by using table 1 of ORO.FTL.205(b)(1) with the reference time of the point of departure. As soon as 48 hours have elapsed, the state of acclimatisation is derived from the time elapsed since reporting at reference time and the number of time zones crossed.

GM2 ORO.FTL.105(1) Definitions

ACCLIMATISED 'POINT OF DEPARTURE'

The point of departure refers to the reporting point for a flight duty period or positioning duty after a rest period.

GM3 ORO.FTL.105(1) Definitions

ACCLIMATISED 'TIME ELAPSED SINCE REPORTING AT REFERENCE TIME'

The time elapsed since reporting at reference time for operations applying CS FTL.1.235(b)(3)(ii) at home base refers to the time elapsed since reporting for the first time at home base for a rotation.

GM1 ORO.FTL.105(2) Definitions

REFERENCE TIME

- (a) Reference time refers to reporting points in a 2-hour wide time zone band around the local time where a crew member is acclimatised.
- (b) Example: A crew member is acclimatised to the local time in Helsinki and reports for duty in London. The reference time is the local time in London.

GM1 ORO.FTL.105(3) Definitions

ADEQUATE FURNITURE FOR 'ACCOMMODATION'

Adequate furniture for crew member accommodation should include a seat that reclines at least 45° back angle to the vertical, has a seat width of at least 20 inches (50cm) and provides leg and foot support.

GM1 ORO.FTL.105(8) Definitions

DETERMINATION OF DISRUPTIVE SCHEDULES

If a crew member is acclimatised to the local time at his/her home base, the local time at the home base should be used to consider an FDP as 'disruptive schedule'. This applies to operations within the 2-hour wide time zone surrounding the local time at the home base, if a crew member is acclimatised to the local time at his/her home base.

GM1 ORO.FTL.105(10) Definitions

ELEMENTS OF STANDBY FOR DUTY

ORO.FTL.225(c) and (d) and CS FTL.1.225(b)(2) determine which elements of standby count as duty.

GM1 ORO.FTL.105(17) Definitions

OPERATING CREW MEMBER

A person on board an aircraft is either a crew member or a passenger. If a crew member is not a passenger on board an aircraft he/she should be considered as 'carrying out duties'. The crew member

remains an operating crew member during in-flight rest. In-flight rest counts in full as FDP, and for the purpose of ORO.FTL.210.

ORO.FTL.110 Operator responsibilities

An operator shall:

- (a) publish duty rosters sufficiently in advance to provide the opportunity for crew members to plan adequate rest;
- (b) ensure that flight duty periods are planned in a way that enables crew members to remain sufficiently free from fatigue so that they can operate to a satisfactory level of safety under all circumstances;
- (c) specify reporting times that allow sufficient time for ground duties;
- (d) take into account the relationship between the frequency and pattern of flight duty periods and rest periods and give consideration to the cumulative effects of undertaking long duty hours combined with minimum rest periods;
- (e) allocate duty patterns which avoid practices that cause a serious disruption of an established sleep/work pattern, such as alternating day/night duties;
- (f) comply with the provisions concerning disruptive schedules in accordance with ARO.OPS.230;
- (g) provide rest periods of sufficient time to enable crew members to overcome the effects of the previous duties and to be rested by the start of the following flight duty period;
- (h) plan recurrent extended recovery rest periods and notify crew members sufficiently in advance;
- (i) plan flight duties in order to be completed within the allowable flight duty period taking into account the time necessary for pre-flight duties, the sector and turnaround times;
- (j) change a schedule and/or crew arrangements if the actual operation exceeds the maximum flight duty period on more than 33% of the flight duties in that schedule during a scheduled seasonal period.

AMC1 ORO.FTL.110 Operator responsibilities**SCHEDULING**

- (a) Scheduling has an important impact on a crew member's ability to sleep and to maintain a proper level of alertness. When developing a workable roster, the operator should strike a fair balance between the commercial needs and the capacity of individual crew members to work effectively. Rosters should be developed in such a way that they distribute the amount of work evenly among those that are involved.
- (b) Schedules should allow for flights to be completed within the maximum permitted flight duty period and flight rosters should take into account the time needed for pre-flight duties, taxiing, the flight- and turnaround times. Other factors to be considered when planning duty periods should include:
 - (1) the allocation of work patterns which avoid undesirable practices such as alternating day/night duties, alternating eastward-westward or westward-eastward time zone transitions, positioning of crew members so that a serious disruption of established sleep/work patterns occurs;
 - (2) scheduling sufficient rest periods especially after long flights crossing many time zones; and
 - (3) preparation of duty rosters sufficiently in advance with planning of recurrent extended recovery rest periods and notification of the crew members well in advance to plan adequate pre-duty rest.

AMC1 ORO.FTL.110(a) Operator responsibilities

PUBLICATION OF ROSTERS

Rosters should be published 14 days in advance.

AMC1 ORO.FTL.110(j) Operator responsibilities

OPERATIONAL ROBUSTNESS OF ROSTERS

The operator should establish and monitor performance indicators for operational robustness of rosters.

GM1 ORO.FTL.110(j) Operator responsibilities

OPERATIONAL ROBUSTNESS OF ROSTERS

Performance indicators for operational robustness of rosters should support the operator in the assessment of the stability of its rostering system. Performance indicators for operational robustness of rosters should at least measure how often a rostered crew pairing for a duty period is achieved within the planned duration of that duty period. Crew pairing means rostered positioning and flights for crew members in one duty period.

ORO.FTL.115 Crew member responsibilities

Crew members shall:

- (a) comply with point CAT.GEN.MPA.100 (b) of Annex IV (Part-CAT); and
- (b) make optimum use of the opportunities and facilities for rest provided and plan and use their rest periods properly.

ORO.FTL.120 Fatigue risk management (FRM)

- (a) When FRM is required by this Subpart or an applicable certification specification, the operator shall establish, implement and maintain a FRM as an integral part of its management system. The FRM shall ensure compliance with the essential requirements in points 7.f., 7.g. and 8.f. of Annex IV to Regulation (EC) No 216/2008. The FRM shall be described in the operations manual.
- (b) The FRM established, implemented and maintained shall provide for continuous improvement to the overall performance of the FRM and shall include:
 - (1) a description of the philosophy and principles of the operator with regard to FRM, referred to as the FRM policy;
 - (2) documentation of the FRM processes, including a process for making personnel aware of their responsibilities and the procedure for amending this documentation;
 - (3) scientific principles and knowledge;
 - (4) a hazard identification and risk assessment process that allows managing the operational risk(s) of the operator arising from crew member fatigue on a continuous basis;
 - (5) a risk mitigation process that provides for remedial actions to be implemented promptly, which are necessary to effectively mitigate the operator's risk(s) arising from crew member fatigue and for continuous monitoring and regular assessment of the mitigation of fatigue risks achieved by such actions;
 - (6) FRM safety assurance processes;
 - (7) FRM promotion processes.
- (c) The FRM shall correspond to the flight time specification scheme, the size of the operator and the nature and complexity of its activities, taking into account the hazards and associated risks inherent in those activities and the applicable flight time specification scheme.
- (d) The operator shall take mitigating actions when the FRM safety assurance process shows that the required safety performance is not maintained.

AMC1 ORO.FTL.120(b)(1) Fatigue risk management (FRM)

CAT OPERATORS FRM POLICY

- (a) The operator's FRM policy should identify all the elements of FRM.
- (b) The FRM policy should define to which operations FRM applies.
- (c) The FRM policy should:
 - (1) reflect the shared responsibility of management, flight and cabin crew, and other involved personnel;
 - (2) state the safety objectives of FRM;
 - (3) be signed by the accountable manager;

- (4) be communicated, with visible endorsement, to all the relevant areas and levels of the organisation;
- (5) declare management commitment to effective safety reporting;
- (6) declare management commitment to the provision of adequate resources for FRM;
- (7) declare management commitment to continuous improvement of FRM;
- (8) require that clear lines of accountability for management, flight and cabin crew, and all other involved personnel are identified; and
- (9) require periodic reviews to ensure it remains relevant and appropriate.

AMC2 ORO.FTL.120(b)(2) Fatigue risk management (FRM)

CAT OPERATORS FRM DOCUMENTATION

The operator should develop and keep current FRM documentation that describes and records:

- (1) FRM policy and objectives;
- (2) FRM processes and procedures;
- (3) accountabilities, responsibilities and authorities for these processes and procedures;
- (4) mechanisms for on-going involvement of management, flight and cabin crew members, and all other involved personnel;
- (5) FRM training programmes, training requirements and attendance records;
- (6) scheduled and actual flight times, duty periods and rest periods with deviations and reasons for deviations; and
- (7) FRM outputs including findings from collected data, recommendations, and actions taken.

AMC1 ORO.FTL.120(b)(4) Fatigue risk management (FRM)

CAT OPERATORS IDENTIFICATION OF HAZARDS

The operator should develop and maintain three documented processes for fatigue hazard identification:

(a) Predictive

The predictive process should identify fatigue hazards by examining crew scheduling and taking into account factors known to affect sleep and fatigue and their effects on performance. Methods of examination may include, but are not limited to:

- (1) operator or industry operational experience and data collected on similar types of operations;
- (2) evidence-based scheduling practices; and
- (3) bio-mathematical models.

(b) Proactive

The proactive process should identify fatigue hazards within current flight operations. Methods of examination may include, but are not limited to:

- (1) self-reporting of fatigue risks;

- (2) crew fatigue surveys;
 - (3) relevant flight and cabin crew performance data;
 - (4) available safety databases and scientific studies; and
 - (5) analysis of planned versus actual time worked.
- (c) Reactive

The reactive process should identify the contribution of fatigue hazards to reports and events associated with potential negative safety consequences in order to determine how the impact of fatigue could have been minimised. At a minimum, the process may be triggered by any of the following:

- (1) fatigue reports;
- (2) confidential reports;
- (3) audit reports;
- (4) incidents; or
- (5) flight data monitoring (FDM) events.

AMC2 ORO.FTL.120(b)(4) Fatigue risk management (FRM)

CAT OPERATORS RISK ASSESSMENT

An operator should develop and implement risk assessment procedures that determine the probability and potential severity of fatigue-related events and identify when the associated risks require mitigation. The risk assessment procedures should review identified hazards and link them to:

- (a) operational processes;
- (b) their probability;
- (c) possible consequences; and
- (d) the effectiveness of existing safety barriers and controls.

AMC1 ORO.FTL.120(b)(5) Fatigue risk management (FRM)

CAT OPERATORS RISK MITIGATION

An operator should develop and implement risk mitigation procedures that:

- (a) select the appropriate mitigation strategies;
- (b) implement the mitigation strategies; and
- (c) monitor the strategies' implementation and effectiveness.

AMC1 ORO.FTL.120(b)(6) Fatigue risk management (FRM)

CAT OPERATORS FRM SAFETY ASSURANCE PROCESSES

The operator should develop and maintain FRM safety assurance processes to:

- (a) provide for continuous FRM performance monitoring, analysis of trends, and measurement to validate the effectiveness of the fatigue safety risk controls. The sources of data may include, but are not limited to:
 - (1) hazard reporting and investigations;
 - (2) audits and surveys; and
 - (3) reviews and fatigue studies;
- (b) provide a formal process for the management of change which should include, but is not limited to:
 - (1) identification of changes in the operational environment that may affect FRM;
 - (2) identification of changes within the organisation that may affect FRM; and
 - (3) consideration of available tools which could be used to maintain or improve FRM performance prior to implementing changes; and
- (c) provide for the continuous improvement of FRM. This should include, but is not limited to:
 - (1) the elimination and/or modification of risk controls have had unintended consequences or that are no longer needed due to changes in the operational or organisational environment;
 - (2) routine evaluations of facilities, equipment, documentation and procedures; and
 - (3) the determination of the need to introduce new processes and procedures to mitigate emerging fatigue-related risks.

AMC1 ORO.FTL.120(b)(7) Fatigue risk management (FRM)

CAT OPERATORS FRM PROMOTION PROCESS

FRM promotion processes should support the on-going development of FRM, the continuous improvement of its overall performance, and attainment of optimum safety levels.

The following should be established and implemented by the operator as part of its FRM:

- (a) training programmes to ensure competency commensurate with the roles and responsibilities of management, flight and cabin crew, and all other involved personnel under the planned FRM; and
- (b) an effective FRM communication plan that:
 - (1) explains FRM policies, procedures and responsibilities to all relevant stakeholders; and
 - (2) describes communication channels used to gather and disseminate FRM-related information.

ORO.FTL.125 Flight time specification schemes

- (a) Operators shall establish, implement and maintain flight time specification schemes that are appropriate for the type(s) of operation performed and that comply with Regulation (EC) No 216/2008, this Subpart and other applicable legislation, including Directive 2000/79/EC.
- (b) Before being implemented, flight time specification schemes, including any related FRM where required, shall be approved by the competent authority.
- (c) To demonstrate compliance with Regulation (EC) No 216/2008 and this Subpart, the operator shall apply the applicable certification specifications adopted by the Agency. Alternatively, if the operator wants to deviate from those certification specifications in accordance with Article 22(2) of Regulation (EC) No 216/2008, it shall provide the competent authority with a full description of the intended deviation prior to implementing it. The description shall include any revisions to manuals or procedures that may be relevant, as well as an assessment demonstrating that the requirements of Regulation (EC) No 216/2008 and of this Subpart are met.
- (d) For the purpose of point ARO.OPS.235(d), within 2 years of the implementation of a deviation or derogation, the operator shall collect data concerning the granted deviation or derogation and analyse that data using scientific principles with a view to assessing the effects of the deviation or derogation on aircrew fatigue. Such analysis shall be provided in the form of a report to the competent authority.

SECTION 2
Commercial Air Transport Operators

ORO.FTL.200 Home base

An operator shall assign a home base to each crew member.

ORO.FTL.205 Flight duty period (FDP)

- (a) The operator shall:
- (1) define reporting times appropriate to each individual operation taking into account ORO.FTL.110(c);
 - (2) establish procedures specifying how the commander shall, in case of special circumstances which could lead to severe fatigue, and after consultation with the crew members concerned, reduce the actual FDP and/or increase the rest period in order to eliminate any detrimental effect on flight safety.
- (b) Basic maximum daily FDP.
- (1) The maximum daily FDP without the use of extensions for acclimatised crew members shall be in accordance with the following table:

Table 2

Maximum daily FDP — Acclimatised crew members

Start of FDP at reference time	1–2 Sectors	3 Sectors	4 Sectors	5 Sectors	6 Sectors	7 Sectors	8 Sectors	9 Sectors	10 Sectors
0600–1329	13:00	12:30	12:00	11:30	11:00	10:30	10:00	09:30	09:00
1330–1359	12:45	12:15	11:45	11:15	10:45	10:15	09:45	09:15	09:00
1400–1429	12:30	12:00	11:30	11:00	10:30	10:00	09:30	09:00	09:00
1430–1459	12:15	11:45	11:15	10:45	10:15	09:45	09:15	09:00	09:00
1500–1529	12:00	11:30	11:00	10:30	10:00	09:30	09:00	09:00	09:00
1530–1559	11:45	11:15	10:45	10:15	09:45	09:15	09:00	09:00	09:00
1600–1629	11:30	11:00	10:30	10:00	09:30	09:00	09:00	09:00	09:00
1630–1659	11:15	10:45	10:15	09:45	09:15	09:00	09:00	09:00	09:00
1700–0459	11:00	10:30	10:00	09:30	09:00	09:00	09:00	09:00	09:00
0500–0514	12:00	11:30	11:00	10:30	10:00	09:30	09:00	09:00	09:00
0515–0529	12:15	11:45	11:15	10:45	10:15	09:45	09:15	09:00	09:00
0530–0544	12:30	12:00	11:30	11:00	10:30	10:00	09:30	09:00	09:00
0545–0559	12:45	12:15	11:45	11:15	10:45	10:15	09:45	09:15	09:00

- (2) The maximum daily FDP when crew members are in an unknown state of acclimatisation shall be in accordance with the following table:

Table 3

Crew members in an unknown state of acclimatisation

Maximum daily FDP according to sectors						
1–2	3	4	5	6	7	8
11:00	10:30	10:00	09:30	09:00	09:00	09:00

- (3) The maximum daily FDP when crew members are in an unknown state of acclimatisation and the operator has implemented a FRM, shall be in accordance with the following table:

Table 4

Crew members in an unknown state of acclimatisation under FRM

The values in the following table may apply provided the operator's FRM continuously monitors that the required safety performance is maintained.

Maximum daily FDP according to sectors						
1–2	3	4	5	6	7	8
12:00	11:30	11:00	10:30	10:00	09:30	09:00

- (c) FDP with different reporting time for flight crew and cabin crew.

Whenever cabin crew requires more time than the flight crew for their pre-flight briefing for the same sector or series of sectors, the FDP of the cabin crew may be extended by the difference in reporting time between the cabin crew and the flight crew. The difference shall not exceed 1 hour. The maximum daily FDP for cabin crew shall be based on the time at which the flight crew report for their FDP, but the FDP shall start at the reporting time of the cabin crew.

- (d) Maximum daily FDP for acclimatised crew members with the use of extensions without in-flight rest.

- (1) The maximum daily FDP may be extended by up to 1 hour not more than twice in any 7 consecutive days. In that case:
 - (i) the minimum pre-flight and post-flight rest periods shall be increased by 2 hours; or
 - (ii) the post-flight rest period shall be increased by 4 hours.
- (2) When extensions are used for consecutive FDPs, the additional pre- and post-flight rest between the two extended FDPs required under subparagraph 1 shall be provided consecutively.
- (3) The use of the extension shall be planned in advance, and shall be limited to a maximum of:
 - (i) 5 sectors when the WOCL is not encroached; or
 - (ii) 4 sectors, when the WOCL is encroached by 2 hours or less; or
 - (iii) 2 sectors, when the WOCL is encroached by more than 2 hours.
- (4) Extension of the maximum basic daily FDP without in-flight rest shall not be combined with extensions due to in-flight rest or split duty in the same duty period.

- (5) Flight time specification schemes shall specify the limits for extensions of the maximum basic daily FDP in accordance with the certification specifications applicable to the type of operation, taking into account:
- (i) the number of sectors flown; and
 - (ii) WOCL encroachment.
- (e) Maximum daily FDP with the use of extensions due to in-flight rest
- Flight time specification schemes shall specify the conditions for extensions of the maximum basic daily FDP with in-flight rest in accordance with the certification specifications applicable to the type of operation, taking into account:
- (i) the number of sectors flown;
 - (ii) the minimum in-flight rest allocated to each crew member;
 - (iii) the type of in-flight rest facilities; and
 - (iv) the augmentation of the basic flight crew.
- (f) Unforeseen circumstances in flight operations — commander's discretion
- (1) The conditions to modify the limits on flight duty, duty and rest periods by the commander in the case of unforeseen circumstances in flight operations, which start at or after the reporting time, shall comply with the following:
- (i) the maximum daily FDP which results after applying points (b) and (e) of point ORO.FTL.205 or point ORO.FTL.220 may not be increased by more than 2 hours unless the flight crew has been augmented, in which case the maximum flight duty period may be increased by not more than 3 hours;
 - (ii) if on the final sector within an FDP the allowed increase is exceeded because of unforeseen circumstances after take-off, the flight may continue to the planned destination or alternate aerodrome; and
 - (iii) the rest period following the FDP may be reduced but can never be less than 10 hours.
- (2) In case of unforeseen circumstances which could lead to severe fatigue, the commander shall reduce the actual flight duty period and/or increase the rest period in order to eliminate any detrimental effect on flight safety.
- (3) The commander shall consult all crew members on their alertness levels before deciding the modifications under subparagraphs 1 and 2.
- (4) The commander shall submit a report to the operator when an FDP is increased or a rest period is reduced at his or her discretion.
- (5) Where the increase of an FDP or reduction of a rest period exceeds 1 hour, a copy of the report, to which the operator shall add its comments, shall be sent by the operator to the competent authority not later than 28 days after the event.
- (6) The operator shall implement a non-punitive process for the use of the discretion described under this provision and shall describe it in the operations manual.
- (g) Unforeseen circumstances in flight operations — delayed reporting
- The operator shall establish procedures, in the operations manual, for delayed reporting in the event of unforeseen circumstances, in accordance with the certification specifications applicable to the type of operation.

GM1 ORO.FTL.205(a)(1) Flight Duty Period (FDP)

REPORTING TIMES

The operator should specify reporting times taking into account the type of operation, the size and type of aircraft and the reporting airport conditions.

GM1 ORO.FTL.205(b)(1) Flight duty period (FDP)

REFERENCE TIME

The start time of the FDP in the table refers to the 'reference time'. That means, to the local time of the point of departure, if this point of departure is within a 2-hour wide time zone band around the local time where a crew member is acclimatised.

AMC1 ORO.FTL.205(f) Flight Duty Period (FDP)

UNFORESEEN CIRCUMSTANCES IN ACTUAL FLIGHT OPERATIONS — COMMANDER'S DISCRETION

- (a) As general guidance when developing a commander's discretion policy, the operator should take into consideration the shared responsibility of management, flight and cabin crew in the case of unforeseen circumstances. The exercise of commander's discretion should be considered exceptional and should be avoided at home base and/or company hubs where standby or reserve crew members should be available. Operators should assess on a regular basis the series of pairings where commander's discretion has been exercised in order to be aware of possible inconsistencies in their rostering.
- (b) The operator's policy on commander's discretion should state the safety objectives, especially in the case of an extended FDP or reduced rest and should take due consideration of additional factors that might decrease a crew member's alertness levels, such as:
- (1) WOCL encroachment;
 - (2) weather conditions;
 - (3) complexity of the operation and/or airport environment;
 - (4) aeroplane malfunctions or specifications;
 - (5) flight with training or supervisory duties;
 - (6) increased number of sectors;
 - (7) circadian disruption; and
 - (8) individual conditions of affected crew members (time since awake, sleep-related factor, workload, etc.).

GM1 ORO.FTL.205(f)(1)(i) Flight Duty Period (FDP)

COMMANDER'S DISCRETION

The maximum basic daily FDP that results after applying ORO.FTL.205(b) should be used to calculate the limits of commander's discretion, if commander's discretion is applied to an FDP which has been extended under the provisions of ORO.FTL.205(d).

ORO.FTL.210 Flight times and duty periods

- (a) The total duty periods to which a crew member may be assigned shall not exceed:
- (1) 60 duty hours in any 7 consecutive days;
 - (2) 110 duty hours in any 14 consecutive days; and
 - (3) 190 duty hours in any 28 consecutive days, spread as evenly as practicable throughout that period.
- (b) The total flight time of the sectors on which an individual crew member is assigned as an operating crew member shall not exceed:
- (1) 100 hours of flight time in any 28 consecutive days;
 - (2) 900 hours of flight time in any calendar year; and
 - (3) 1 000 hours of flight time in any 12 consecutive calendar months.
- (c) Post-flight duty shall count as duty period. The operator shall specify in its operations manual the minimum time period for post-flight duties.

AMC1 ORO.FTL.210(c) Flight times and duty periods

POST-FLIGHT DUTIES

The operator should specify post-flight duty times taking into account the type of operation, the size and type of aircraft and the airport conditions.

ORO.FTL.215 Positioning

If an operator positions a crew member, the following shall apply:

- (a) positioning after reporting but prior to operating shall be counted as FDP but shall not count as a sector;
- (b) all time spent on positioning shall count as duty period.

ORO.FTL.220 Split duty

The conditions for extending the basic maximum daily FDP due to a break on the ground shall be in accordance with the following:

- (a) flight time specification schemes shall specify the following elements for split duty in accordance with the certification specifications applicable to the type of operation:
 - (1) the minimum duration of a break on the ground; and
 - (2) the possibility to extend the FDP prescribed under point ORO.FTL.205(b) taking into account the duration of the break on the ground, the facilities provided to the crew member to rest and other relevant factors;
- (b) the break on the ground shall count in full as FDP;
- (c) split duty shall not follow a reduced rest.

ORO.FTL.225 Standby and duties at the airport

If an operator assigns crew members to standby or to any duty at the airport, the following shall apply in accordance with the certification specifications applicable to the type of operation:

- (a) standby and any duty at the airport shall be in the roster and the start and end time of standby shall be defined and notified in advance to the crew members concerned to provide them with the opportunity to plan adequate rest;
- (b) a crew member is considered on airport standby from reporting at the reporting point until the end of the notified airport standby period;
- (c) airport standby shall count in full as duty period for the purpose of points ORO.FTL.210 and ORO.FTL.235;
- (d) any duty at the airport shall count in full as duty period and the FDP shall count in full from the airport duty reporting time;
- (e) the operator shall provide accommodation to the crew member on airport standby;
- (f) flight time specification schemes shall specify the following elements:
 - (1) the maximum duration of any standby;
 - (2) the impact of the time spent on standby on the maximum FDP that may be assigned, taking into account facilities provided to the crew member to rest, and other relevant factors such as:
 - the need for immediate readiness of the crew member,
 - the interference of standby with sleep, and
 - sufficient notification to protect a sleep opportunity between the call for duty and the assigned FDP;

- (3) the minimum rest period following standby which does not lead to assignment of an FDP;
- (4) how time spent on standby other than airport standby shall be counted for the purpose of cumulative duty periods.

ORO.FTL.230 Reserve

If an operator assigns crew members to reserve, the following requirements shall apply in accordance with the certification specifications applicable to the type of operation:

- (a) reserve shall be in the roster;
- (b) flight time specification schemes shall specify the following elements:
 - (1) the maximum duration of any single reserve period;
 - (2) the number of consecutive reserve days that may be assigned to a crew member.

GM1 ORO.FTL.230(a) Reserve**ROSTERING OF RESERVE**

Including reserve in a roster, also referred to as 'rostering', implies that a reserve period that does not result in a duty period may not retrospectively be considered as part of a recurrent extended recovery rest period.

ORO.FTL.235 Rest periods

- (a) Minimum rest period at home base.
- (1) The minimum rest period provided before undertaking an FDP starting at home base shall be at least as long as the preceding duty period, or 12 hours, whichever is greater.
 - (2) By way of derogation from point (1), the minimum rest provided under point (b) applies if the operator provides suitable accommodation to the crew member at home base.
- (b) Minimum rest period away from home base.
- The minimum rest period provided before undertaking an FDP starting away from home base shall be at least as long as the preceding duty period, or 10 hours, whichever is greater. This period shall include an 8-hour sleep opportunity in addition to the time for travelling and physiological needs.
- (c) Reduced rest
- By derogation from points (a) and (b), flight time specification schemes may reduce the minimum rest periods in accordance with the certification specifications applicable to the type of operation and taking into account the following elements:
- (1) the minimum reduced rest period;
 - (2) the increase of the subsequent rest period; and
 - (3) the reduction of the FDP following the reduced rest.
- (d) Recurrent extended recovery rest periods
- Flight time specification schemes shall specify recurrent extended recovery rest periods to compensate for cumulative fatigue. The minimum recurrent extended recovery rest period shall be 36 hours, including 2 local nights, and in any case the time between the end of one recurrent extended recovery rest period and the start of the next extended recovery rest period shall not be more than 168 hours. The recurrent extended recovery rest period shall be increased to 2 local days twice every month.
- (e) Flight time specification schemes shall specify additional rest periods in accordance with the applicable certification specifications to compensate for:
- (1) the effects of time zone differences and extensions of the FDP;
 - (2) additional cumulative fatigue due to disruptive schedules; and
 - (3) a change of home base.

GM1 ORO.FTL.235(a)(2) Rest periods**MINIMUM REST PERIOD AT HOME BASE IF SUITABLE ACCOMMODATION IS PROVIDED**

An operator may apply the minimum rest period away from home base during a rotation which includes a rest period at a crew member's home base. This applies only if the crew member does not rest at his/her residence, or temporary accommodation, because the operator provides suitable accommodation. This type of roster is known as "back-to-back operation".

AMC1 ORO.FTL.235(b) Rest periods

MINIMUM REST PERIOD AWAY FROM HOME BASE

The time allowed for physiological needs should be 1 hour. Consequently, if the travelling time to the suitable accommodation is more than 30 minutes, the operator should increase the rest period by twice the amount of difference of travelling time above 30 minutes.

ORO.FTL.240 Nutrition

- (a) During the FDP there shall be the opportunity for a meal and drink in order to avoid any detriment to a crew member's performance, especially when the FDP exceeds 6 hours.
- (b) An operator shall specify in its operations manual how the crew member's nutrition during FDP is ensured.

AMC1 ORO.FTL.240 Nutrition

MEAL OPPORTUNITY

- (a) The operations manual should specify the minimum duration of the meal opportunity, when a meal opportunity is provided, in particular when the FDP encompasses the regular meal windows (e.g. if the FDP starts at 11:00 hours and ends at 22:00 hours meal opportunities for two meals should be given).
- (b) It should define the time frames in which a regular meal should be consumed in order not to alter the human needs for nutrition without affecting the crew member's body rhythms.

ORO.FTL.245 Records of home base, flight times, duty and rest periods

- (a) An operator shall maintain, for a period of 24 months:
- (1) individual records for each crew member including:
 - (i) flight times;
 - (ii) start, duration and end of each duty period and FDP;
 - (iii) rest periods and days free of all duties; and
 - (iv) assigned home base;
 - (2) reports on extended flight duty periods and reduced rest periods.
- (b) Upon request, the operator shall provide copies of individual records of flight times, duty periods and rest periods to:
- (1) the crew member concerned; and
 - (2) to another operator, in relation to a crew member who is or becomes a crew member of the operator concerned.
- (c) Records referred to in point CAT.GEN.MPA.100(b)(5) in relation to crew members who undertake duties for more than one operator shall be kept for a period of 24 months.

ORO.FTL.250 Fatigue management training

- (a) The operator shall provide initial and recurrent fatigue management training to crew members, personnel responsible for preparation and maintenance of crew rosters and management personnel concerned.
- (b) This training shall follow a training programme established by the operator and described in the operations manual. The training syllabus shall cover the possible causes and effects of fatigue and fatigue countermeasure.

AMC1 ORO.FTL.250 Fatigue management training

TRAINING SYLLABUS FATIGUE MANAGEMENT TRAINING

The training syllabus should contain the following:

- (a) applicable regulatory requirements for flight, duty and rest;
- (b) the basics of fatigue including sleep fundamentals and the effects of disturbing the circadian rhythms;
- (c) the causes of fatigue, including medical conditions that may lead to fatigue;
- (d) the effect of fatigue on performance;
- (e) fatigue countermeasures;
- (f) the influence of lifestyle, including nutrition, exercise, and family life, on fatigue;
- (g) familiarity with sleep disorders and their possible treatments;
- (h) where applicable, the effects of long range operations and heavy short range schedules on individuals;
- (i) the effect of operating through and within multiple time zones; and
- (j) the crew member responsibility for ensuring adequate rest and fitness for flight duty.

**CERTIFICATION SPECIFICATIONS
AND GUIDANCE MATERIAL
FOR COMMERCIAL AIR TRANSPORT BY AEROPLANE
— SCHEDULED AND CHARTER OPERATIONS**

CS FTL.1.100 Applicability

These Certification Specifications are applicable to commercial air transport by aeroplanes for scheduled and charter operations, excluding emergency medical service (EMS), air taxi and single pilot operations.

CS FTL.1.200 Home base

- (a) The home base is a single airport location assigned with a high degree of permanence.
- (b) In the case of a change of home base, the first recurrent extended recovery rest period prior to starting duty at the new home base is increased to 72 hours, including 3 local nights. Travelling time between the former home base and the new home base is positioning.

GM1 CS FTL.1.200 Home base**TRAVELLING TIME**

Crew members should consider making arrangements for temporary accommodation closer to their home base if the travelling time from their residence to their home base usually exceeds 90 minutes.

CS FTL.1.205 Flight duty period (FDP)

- (a) Night duties under the provisions of ORO.FTL.205(b) and (d) comply with the following:
 - (1) When establishing the maximum FDP for consecutive night duties, the number of sectors is limited to 4 sectors per duty. (2) The operator applies appropriate fatigue risk management to actively manage the fatiguing effect of night duties of more than 10 hours in relation to the surrounding duties and rest periods.
- (b) Extension of FDP without in-flight rest

The extension of FDP without in-flight rest under the provisions of ORO.FTL.205(d)(5) is limited to the values specified in the table below.

Maximum daily FDP with extension

Starting time of FDP	1–2 sectors (in hours)	3 sectors (in hours)	4 sectors (in hours)	5 sectors (in hours)
0600–0614	Not allowed	Not allowed	Not allowed	Not allowed
0615–0629	13:15	12:45	12:15	11:45
0630–0644	13:30	13:00	12:30	12:00
0645–0659	13:45	13:15	12:45	12:15

0700–1329	14:00	13:30	13:00	12:30
1330–1359	13:45	13:15	12:45	Not allowed
1400–1429	13:30	13:00	12:30	Not allowed
1430–1459	13:15	12:45	12:15	Not allowed
1500–1529	13:00	12:30	12:00	Not allowed
1530–1559	12:45	Not allowed	Not allowed	Not allowed
1600–1629	12:30	Not allowed	Not allowed	Not allowed
1630–1659	12:15	Not allowed	Not allowed	Not allowed
1700–1729	12:00	Not allowed	Not allowed	Not allowed
1730–1759	11:45	Not allowed	Not allowed	Not allowed
1800–1829	11:30	Not allowed	Not allowed	Not allowed
1830–1859	11:15	Not allowed	Not allowed	Not allowed
1900–0359	Not allowed	Not allowed	Not allowed	Not allowed
0400–0414	Not allowed	Not allowed	Not allowed	Not allowed
0415–0429	Not allowed	Not allowed	Not allowed	Not allowed
0430–0444	Not allowed	Not allowed	Not allowed	Not allowed
0445–0459	Not allowed	Not allowed	Not allowed	Not allowed
0500–0514	Not allowed	Not allowed	Not allowed	Not allowed
0515–0529	Not allowed	Not allowed	Not allowed	Not allowed
0530–0544	Not allowed	Not allowed	Not allowed	Not allowed
0545–0559	Not allowed	Not allowed	Not allowed	Not allowed

(c) Extension of FDP due to in-flight rest

In-flight rest facilities in accordance with ORO.FTL.205(e)(iii) fulfil the following minimum standards:

- ‘Class 1 rest facility’ means a bunk or other surface that allows for a flat or near flat sleeping position. It reclines to at least 80° back angle to the vertical and is located separately from both the flight crew compartment and the passenger cabin in an area that allows the crew member to control light, and provides isolation from noise and disturbance;

- ‘Class 2 rest facility’ means a seat in an aircraft cabin that reclines at least 45° back angle to the vertical, has at least a pitch of 55 inches (137,5 cm), a seat width of at least 20 inches (50 cm) and provides leg and foot support. It is separated from passengers by at least a curtain to provide darkness and some sound mitigation, and is reasonably free from disturbance by passengers or crew members;
 - ‘Class 3 rest facility’ means a seat in an aircraft cabin or flight crew compartment that reclines at least 40° from the vertical, provides leg and foot support and is separated from passengers by at least a curtain to provide darkness and some sound mitigation, and is not adjacent to any seat occupied by passengers.
- (1) The extension of FDP with in-flight rest under the provisions of ORO.FTL.205(e) complies with the following:
- (i) the FDP is limited to 3 sectors; and
 - (ii) the minimum in-flight rest period is a consecutive 90-minute period for each crew member and 2 consecutive hours for the flight crew members at control during landing.
- (2) The maximum daily FDP under the provisions of ORO.FTL.205 (e) may be extended due to in-flight rest for flight crew:
- (i) with one additional flight crew member:
 - (A) up to 14 hours with class 3 rest facilities;
 - (B) up to 15 hours with class 2 rest facilities; or
 - (C) up to 16 hours with class 1 rest facilities;
 - (ii) with two additional flight crew members:
 - (A) up to 15 hours with class 3 rest facilities;
 - (B) up to 16 hours with class 2 rest facilities; or
 - (C) up to 17 hours with class 1 rest facilities.
- (3) The minimum in-flight rest for each cabin crew member is:

Maximum extended FDP	Minimum in-flight rest (in hours)		
	Class 1	Class 2	Class 3
up to 14:30 hrs	1:30	1:30	1:30
14:31 – 15:00 hrs	1:45	2:00	2:20
15:01 – 15:30 hrs	2:00	2:20	2:40
15:31 – 16:00 hrs	2:15	2:40	3:00
16:01 – 16:30 hrs	2:35	3:00	Not allowed
16:31 – 17:00 hrs	3:00	3:25	Not allowed
17:01 – 17:30 hrs	3:25	Not allowed	Not allowed

17:31 – 18:00 hrs	3:50	Not allowed	Not allowed
-------------------	------	-------------	-------------

- (4) The limits specified in (2) may be increased by 1 hour for FDPs that include 1 sector of more than 9 hours of continuous flight time and a maximum of 2 sectors.
- (5) All time spent in the rest facility is counted as FDP.
- (6) The minimum rest at destination is at least as long as the preceding duty period, or 14 hours, whichever is greater.
- (7) A crew member does not start a positioning sector to become part of this operating crew on the same flight.
- (d) Unforeseen circumstances in flight operations — delayed reporting
- (1) The operator may delay the reporting time in the event of unforeseen circumstances, if procedures for delayed reporting are established in the operations manual. The operator keeps records of delayed reporting. Delayed reporting procedures establish a notification time allowing a crew member to remain in his/her suitable accommodation when the delayed reporting procedure is activated. In such a case, if the crew member is informed of the delayed reporting time, the FDP is calculated as follows:
- (i) one notification of a delay leads to the calculation of the maximum FDP according to (iii) or (iv);
 - (ii) if the reporting time is further amended, the FDP starts counting 1 hour after the second notification or at the original delayed reporting time if this is earlier;
 - (iii) when the delay is less than 4 hours, the maximum FDP is calculated based on the original reporting time and the FDP starts counting at the delayed reporting time;
 - (iv) when the delay is 4 hours or more, the maximum FDP is calculated based on the more limiting of the original or the delayed reporting time and the FDP starts counting at the delayed reporting time;
 - (v) as an exception to (i) and (ii), when the operator informs the crew member of a delay of 10 hours or more in reporting time and the crew member is not further disturbed by the operator, such delay of 10 hours or more counts as a rest period.

GM1 CS FTL.1.205(a)(2) Flight duty period (FDP)

NIGHT DUTIES – APPROPRIATE FATIGUE RISK MANAGEMENT

- (a) When rostering night duties of more than 10 hours (referred to below as ‘long night duties’), it is critical for the crew member to obtain sufficient sleep before such duties when he/she is adapted to being awake during day time hours at the local time where he/she is acclimatised. To optimise alertness on long night duties, the likelihood of obtaining sleep as close as possible to the start of the FDP should be considered, when rostering rest periods before long night duties, by providing sufficient time to the crew member to adapt to being awake during the night. Rostering practices leading to extended wakefulness before reporting for such duties should be avoided. Fatigue risk management principles that could be applied to the rostering of long night duties may include:
- (1) avoiding long night duties after extended recovery rest periods
 - (2) progressively delaying the rostered ending time of the FDPs preceding long night duties;
 - (3) starting a block of night duties with a shorter FDP; and

- (4) avoiding the sequence of early starts and long night duties.
- (b) Fatigue risk management principles may be applied to the rostering of long night duties by means of:
 - (1) considering operator or industry operational experience and data collected on similar operations;
 - (2) evidence-based scheduling practices; and
 - (3) bio-mathematical models.

GM1 CS FTL.1.205(c)(1)(ii) Flight Duty Period (FDP)

IN-FLIGHT REST

In-flight rest should be taken during the cruise phase of the flight.

GM2 CS FTL.1.205(c)(1)(ii) Flight Duty Period (FDP)

IN-FLIGHT REST

In-flight rest periods should be allocated in order to optimise the alertness of those flight crew members at control during landing.

GM1 CS FTL.1.205(d) Flight Duty Period (FDP)

DELAYED REPORTING

Operator procedures for delayed reporting should:

- (a) specify a contacting mode;
- (b) establish minimum and maximum notification times; and
- (c) avoid interference with sleeping patterns when possible.

CS FTL.1.220 Split duty

The increase of limits on flight duty, under the provisions of ORO.FTL.220, complies with the following:

- (a) The break on the ground within the FDP has a minimum duration of 3 consecutive hours.
- (b) The break excludes the time allowed for post and pre-flight duties and travelling. The minimum total time for post and pre-flight duties and travelling is 30 minutes. The operator specifies the actual times in its operations manual.
- (c) The maximum FDP specified in ORO.FTL.205(b) may be increased by up to 50 % of the break.
- (d) Suitable accommodation is provided either for a break of 6 hours or more or for a break that encroaches the window of circadian low (WOCL).
- (e) In all other cases:
 - (1) accommodation is provided; and
 - (2) any time of the actual break exceeding 6 hours or any time of the break that encroaches the WOCL does not count for the extension of the FDP.
- (f) Split duty cannot be combined with in-flight rest.

GM1 CS FTL.1.220(b) Split duty**POST, PRE-FLIGHT DUTY AND TRAVELLING TIMES**

The operator should specify post and pre-flight duty and travelling times taking into account aircraft type, type of operation and airport conditions.

CS FTL.1.225 Standby

The modification of limits on flight duty, duty and rest periods under the provisions of ORO.FTL.225 complies with the following:

- (a) Airport standby
 - (1) If not leading to the assignment of an FDP, airport standby is followed by a rest period as specified in ORO.FTL.235.
 - (2) If an assigned FDP starts during airport standby, the following applies:
 - (i) the FDP counts from the start of the FDP. The maximum FDP is reduced by any time spent on standby in excess of 4 hours;
 - (ii) the maximum combined duration of airport standby and assigned FDP as specified in ORO.FTL.205(b) and (d) is 16 hours.
- (b) Standby other than airport standby:
 - (1) the maximum duration of standby other than airport standby is 16 hours;
 - (2) The operator's standby procedures are designed to ensure that the combination of standby and FDP do not lead to more than 18 hours awake time;
 - (3) 25 % of time spent on standby other than airport standby counts as duty time for the purpose of ORO.FTL.210;
 - (4) standby is followed by a rest period in accordance with ORO.FTL.235;
 - (5) standby ceases when the crew member reports at the designated reporting point;
 - (6) if standby ceases within the first 6 hours, the maximum FDP counts from reporting;
 - (7) if standby ceases after the first 6 hours, the maximum FDP is reduced by the amount of standby time exceeding 6 hours;
 - (8) if the FDP is extended due to in-flight rest according to CS FTL.1.205(c), or to split duty according to CS FTL.1.220, the 6 hours of paragraph (6) and (7) are extended to 8 hours;
 - (9) if standby starts between 23:00 and 07:00, the time between 23:00 and 07:00 does not count towards the reduction of the FDP under (6), (7) and (8) until the crew member is contacted by the operator; and
 - (10) the response time between call and reporting time established by the operator allows the crew member to arrive from his/her place of rest to the designated reporting point within a reasonable time.

GM1 CS FTL.1.225 Standby**MINIMUM REST AND STANDBY**

- (a) If airport or other standby initially assigned is reduced by the operator during standby that does not lead to an assignment to a flight duty period, the minimum rest requirements specified in ORO.FTL.235 should apply.
- (b) If a minimum rest period as specified in ORO.FTL.235 is provided before reporting for the duty assigned during the standby, this time period should not count as standby duty.
- (c) Standby other than airport standby counts (partly) as duty for the purpose of ORO.FTL.210 only. If a crew member receives an assignment during standby other than airport standby, the actual reporting time at the designated reporting point should be used for the purpose of ORO.FTL.235.

GM1 CS FTL.1.225(b) Standby

STANDBY OTHER THAN AIRPORT STANDBY NOTIFICATION

Operator procedures for the notification of assigned duties during standby other than airport standby should avoid interference with sleeping patterns if possible.

GM1 CS FTL.1.225(b)(2) Standby

AWAKE TIME

Scientific research shows that continuous awake in excess of 18 hours can reduce the alertness and should be avoided.

CS FTL.1.230 Reserve

The operator assigns duties to a crew member on reserve under the provisions of ORO.FTL.230 complying with the following:

- (a) An assigned FDP counts from the reporting time.
- (b) Reserve times do not count as duty period for the purpose of ORO.FTL.210 and ORO.FTL.235.
- (c) The operator defines the maximum number of consecutive reserve days within the limits of ORO.FTL.235(d).
- (d) To protect an 8-hour sleep opportunity, the operator rosters a period of 8 hours, taking into account fatigue management principles, for each reserve day during which a crew member on reserve is not contacted by the operator.

GM1 CS FTL.1.230 Reserve

RESERVE NOTIFICATION

Operator procedures for the notification of assigned duties during reserve should avoid interference with sleeping patterns if possible.

GM2 CS FTL.1.230 Reserve

NOTIFICATION IN ADVANCE

The minimum 'at least 10 hours' between the notification of an assignment for any duty and reporting for that duty during reserve may include the period of 8 hours during which a crew member on reserve is not contacted by the operator.

GM1 CS FTL.1.230(c) Reserve

RECURRENT EXTENDED RECOVERY REST

ORO.FTL.235(d) applies to a crew member on reserve.

CS FTL.1.235 Rest periods

- (a) Disruptive schedules
- (1) If a transition from a late finish/night duty to an early start is planned at home base, the rest period between the 2 FDPs includes 1 local night.
 - (2) If a crew member performs 4 or more night duties, early starts or late finishes between 2 extended recovery rest periods as defined in ORO.FTL.235(d), the second extended recovery rest period is extended to 60 hours.

(b) Time zone differences

- (1) For the purpose of ORO.FTL.235(e)(1), 'rotation' is a series of duties, including at least one flight duty, and rest period out of home base, starting at home base and ending when returning to home base for a rest period where the operator is no longer responsible for the accommodation of the crew member.
- (2) The operator monitors rotations and combinations of rotations in terms of their effect on crew member fatigue, and adapts the rosters as necessary.
- (3) Time zone differences are compensated by additional rest, as follows:
 - (i) At home base, if a rotation involves a 4 hour time difference or more, the minimum rest is as specified in the following table.

Minimum local nights of rest at home base to compensate for time zone differences

Maximum time difference (h) between reference time and local time where a crew member rests during a rotation	Time elapsed (h) since reporting for the first FDP in a rotation involving at least 4 hour time difference to the reference time			
	< 48	48 – 71:59	72 – 95:59	≥96
≤6	2	2	3	3
≤9	2	3	3	4
≤12	2	3	4	5

- (ii) Away from home base, if an FDP involves a 4-hour time difference or more, the minimum rest following that FDP is at least as long as the preceding duty period, or 14 hours, whichever is greater. By way of derogation from point (b)(3)(i) and only once between 2 recurrent extended recovery rest periods as specified in ORO.FTL.235(d), the minimum rest provided under this point (b)(3)(ii) may also apply to home base if the operator provides suitable accommodation to the crew member.
 - (4) In case of an Eastward-Westward or Westward-Eastward transition, at least 3 local nights of rest at home base are provided between alternating rotations.
 - (5) The monitoring of combinations of rotations is conducted under the operator's management system provisions.
- (c) Reduced rest

- (1) The minimum reduced rest periods under reduced rest arrangements are 12 hours at home base and 10 hours out of base.
- (2) Reduced rest is used under fatigue risk management.
- (3) The rest period following the reduced rest is extended by the difference between the minimum rest period specified in ORO.FTL.235(a) or (b) and the reduced rest.
- (4) The FDP following the reduced rest is reduced by the difference between the minimum rest period specified in ORO.FTL.235(a) or (b) as applicable and the reduced rest.
- (5) There is a maximum of 2 reduced rest periods between 2 recurrent extended recovery rest periods specified in accordance with ORO.FTL.235(d).

GM1 CS FTL.1.235(b)(3) Rest periods

TIME ELAPSED SINCE REPORTING

The time elapsed since reporting for a rotation involving at least a 4-hour time difference to the reference time stops counting when the crew member returns to his/her home base for a rest period during which the operator is no longer responsible for the accommodation of the crew member.

APPENDIX I

DECLARATION
in accordance with Commission Regulation (EC) No 965/2012 on Air operations
Operator Name: Place in which the operator is established or residing and place from which the operations are directed: Name and contact details of the accountable manager:
Continuing airworthiness management organisation in accordance with Regulation (EC) No 2042/2003 Name and address of the organisation and approval reference (as per EASA Form 14)
Aircraft operation
Starting date of operation/applicability date of the change:
Type(s) of operation: <input type="checkbox"/> Part-NCC: (specify if passenger and/or cargo) <input type="checkbox"/> Part-SPO: (specify which type of activity)
Type(s) of aircraft, registration(s) and main base:
Details of approvals held (attach list of specific approvals to the declaration, if applicable)
Details of specialised operations authorisation held (attach authorisations, if applicable)
List of alternative means of compliance with references to the AMCs they replace (attach to the declaration)
Statements
<input type="checkbox"/> The management system documentation including the operations manual reflect the applicable requirements set out in Part-ORO, Part-NCC, Part-SPO and Part-SPA. All flights will be carried out in accordance with the procedures and instructions specified in the operations manual.
<input type="checkbox"/> All aircraft operated hold a valid certificate of airworthiness and comply with Commission Regulation (EC) No 2042/2003.
<input type="checkbox"/> All flight crew members and cabin crew members as applicable, are trained in accordance with the applicable requirements.
<input type="checkbox"/> (If applicable) The operator has implemented and demonstrated conformance to an officially recognised industry standard. Reference of the standard: Certification body:

Date of the last conformance audit:

Any change in the operation that affects the information disclosed in this declaration will be notified to the competent authority.

The operator confirms that the information disclosed in this declaration is correct.

Date, name and signature of the accountable manager

ANNEX IV

Commercial Air Transport Operations

[Part-CAT]

SUBPART A: GENERAL REQUIREMENTS

CAT.GEN.100 Competent authority

The competent authority shall be the authority designated by the Member State in which the operator has its principal place of business.

CAT.GEN.105 Touring motor gliders, powered sailplanes and mixed balloons

- (a) Powered sailplanes, excluding touring motor gliders, shall be operated and equipped in compliance with the requirements applicable to sailplanes.
- (b) Touring motor gliders (TMGs) shall be operated following the requirements for:
 - (1) aeroplanes when they are power-driven by an engine; and
 - (2) sailplanes when operated without using an engine.
- (c) TMGs shall be equipped in compliance with the requirements applicable to aeroplanes, unless otherwise specified in CAT.IDE.A.
- (d) Mixed balloons shall be operated in accordance with the requirements for hot-air balloons.

SECTION 1
Motor-powered aircraft

CAT.GEN.MPA.100 Crew responsibilities

- (a) The crew member shall be responsible for the proper execution of his/her duties that are:
- (1) related to the safety of the aircraft and its occupants; and
 - (2) specified in the instructions and procedures in the operations manual.
- (b) The crew member shall:
- (1) report to the commander any fault, failure, malfunction or defect which the crew member believes may affect the airworthiness or safe operation of the aircraft including emergency systems, if not already reported by another crew member;
 - (2) report to the commander any incident that endangered, or could have endangered, the safety of the operation, if not already reported by another crew member;
 - (3) comply with the relevant requirements of the operator's occurrence reporting schemes;
 - (4) comply with all flight and duty time limitations (FTL) and rest requirements applicable to their activities;
 - (5) when undertaking duties for more than one operator:
 - (i) maintain his/her individual records regarding flight and duty times and rest periods as referred to in applicable FTL requirements; and
 - (ii) provide each operator with the data needed to schedule activities in accordance with the applicable FTL requirements.
- (c) The crew member shall not perform duties on an aircraft:
- (1) when under the influence of psychoactive substances or alcohol or when unfit due to injury, fatigue, medication, sickness or other similar causes;
 - (2) until a reasonable time period has elapsed after deep water diving or following blood donation;
 - (3) if applicable medical requirements are not fulfilled;
 - (4) if he/she is in any doubt of being able to accomplish his/her assigned duties; or
 - (5) if he/she knows or suspects that he/she is suffering from fatigue as referred to in 7.f of Annex IV to Regulation (EC) No 216/2008 or feels otherwise unfit, to the extent that the flight may be endangered.

AMC1 CAT.GEN.MPA.100(b) Crew responsibilities

COPIES OF REPORTS

Where a written report is required, a copy of the report should be communicated to the commander concerned unless the terms of the operator's reporting schemes prevent this.

AMC1 CAT.GEN.MPA.100(c)(1) Crew responsibilities

ALCOHOL CONSUMPTION

The operator should issue instructions concerning the consumption of alcohol by crew members. The instructions should be not less restrictive than the following:

- (a) no alcohol should be consumed less than 8 hours prior to the specified reporting time for a flight duty period or the commencement of standby;
- (b) the blood alcohol level should not exceed the lower of the national requirements or 0.2 per thousand at the start of a flight duty period;
- (c) no alcohol should be consumed during the flight duty period or whilst on standby.

GM1 CAT.GEN.MPA.100(c)(2) Crew responsibilities

ELAPSED TIME BEFORE RETURNING TO FLYING DUTY

24 hours is a suitable minimum length of time to allow after normal blood donation or normal recreational (sport) diving before returning to flying duties. This should be considered by operators when determining a reasonable time period for the guidance of crew members.

PART-MED

Information on the effects of medication, drugs, other treatments and alcohol can be found in Annex IV (Part-MED) to Commission Regulation (EU) No 1178/2011¹.

¹ Commission Regulation (EU) No 1178/2011 of 3 November 2011 laying down technical requirements and administrative procedures related to civil aviation aircrew pursuant to Regulation (EC) No 216/2008 of the European Parliament and of the Council (OJ L 311, 25.11.2011, p. 1).

CAT.GEN.MPA.105 Responsibilities of the commander

- (a) The commander, in addition to complying with CAT.GEN.MPA.100, shall:
- (1) be responsible for the safety of all crew members, passengers and cargo on board, as soon as the commander arrives on board the aircraft, until the commander leaves the aircraft at the end of the flight;
 - (2) be responsible for the operation and safety of the aircraft:
 - (i) for aeroplanes, from the moment the aeroplane is first ready to move for the purpose of taxiing prior to take-off, until the moment it finally comes to rest at the end of the flight and the engine(s) used as primary propulsion unit(s) is(are) shut down;
 - (ii) for helicopters, when the rotors are turning;
 - (3) have authority to give all commands and take any appropriate actions for the purpose of securing the safety of the aircraft and of persons and/or property carried therein in accordance with 7.c of Annex IV to Regulation (EC) No 216/2008;
 - (4) have authority to disembark any person, or any part of the cargo, that may represent a potential hazard to the safety of the aircraft or its occupants;
 - (5) not allow a person to be carried in the aircraft who appears to be under the influence of alcohol or drugs to the extent that the safety of the aircraft or its occupants is likely to be endangered;
 - (6) have the right to refuse transportation of inadmissible passengers, deportees or persons in custody if their carriage increases the risk to the safety of the aircraft or its occupants;
 - (7) ensure that all passengers are briefed on the location of emergency exits and the location and use of relevant safety and emergency equipment;
 - (8) ensure that all operational procedures and checklists are complied with in accordance with the operations manual;
 - (9) not permit any crew member to perform any activity during critical phases of flight, except duties required for the safe operation of the aircraft;
 - (10) ensure that:
 - (i) flight recorders are not disabled or switched off during flight;
 - (ii) in the event of an occurrence other than an accident or a serious incident that shall be reported according to ORO.GEN.160(a), flight recorders' recordings are not intentionally erased; and
 - (iii) in the event of an accident or a serious incident, or if preservation of recordings of flight recorders is directed by the investigating authority:
 - (A) flight recorders' recordings are not intentionally erased;
 - (B) flight recorders are deactivated immediately after the flight is completed; and
 - (C) precautionary measures to preserve the recordings of flight recorders are taken before leaving the flight crew compartment;
 - (11) decide on acceptance of the aircraft with unserviceabilities in accordance with the configuration deviation list (CDL) or the minimum equipment list (MEL);
 - (12) ensure that the pre-flight inspection has been carried out in accordance with the requirements of Annex I (Part-M) to Regulation (EC) No 2042/2003;

- (13) be satisfied that relevant emergency equipment remains easily accessible for immediate use.
- (b) The commander, or the pilot to whom conduct of the flight has been delegated, shall, in an emergency situation that requires immediate decision and action, take any action he/she considers necessary under the circumstances in accordance with 7.d of Annex IV to Regulation (EC) No 216/2008. In such cases he/she may deviate from rules, operational procedures and methods in the interest of safety.
- (c) Whenever an aircraft in flight has manoeuvred in response to an airborne collision avoidance system (ACAS) resolution advisory (RA), the commander shall submit an ACAS report to the competent authority.
- (d) Bird hazards and strikes:
- (1) Whenever a potential bird hazard is observed, the commander shall inform the air traffic service (ATS) unit as soon as flight crew workload allows.
 - (2) Whenever an aircraft for which the commander is responsible suffers a bird strike that results in significant damage to the aircraft or the loss or malfunction of any essential service, the commander shall submit a written bird strike report after landing to the competent authority.

GM1 CAT.GEN.MPA.105(a)(10) Responsibilities of the commander

IDENTIFICATION OF THE SEVERITY OF AN OCCURRENCE BY THE COMMANDER

The definitions of an accident and a serious incident as well as examples thereof can be found in Regulation (EU) No 996/2010 of the European Parliament and of the Council.

CAT.GEN.MPA.110 Authority of the commander

The operator shall take all reasonable measures to ensure that all persons carried in the aircraft obey all lawful commands given by the commander for the purpose of securing the safety of the aircraft and of persons or property carried therein.

CAT.GEN.MPA.115 Personnel or crew members other than cabin crew in the passenger compartment

The operator shall ensure that personnel or crew members, other than operating cabin crew members, carrying out their duties in the passenger compartment of an aircraft:

- (a) are not confused by the passengers with operating cabin crew members;
- (b) do not occupy required cabin crew assigned stations;
- (c) do not impede operating cabin crew members in their duties.

AMC1 CAT.GEN.MPA.115(a) Personnel or crew members other than cabin crew in the passenger compartment**MEASURES TO PREVENT CONFUSION BY PASSENGERS**

If personnel or crew members other than operating cabin crew members carry out duties in a passenger compartment, the operator should ensure that they do not perform tasks or wear a uniform in such a way that might identify them as members of the operating cabin crew.

GM1 CAT.GEN.MPA.115 Personnel or crew members other than cabin crew in the passenger compartment**POSITIONING CABIN CREW MEMBERS**

To prevent confusion by passengers and undue expectations in case of emergency, positioning cabin crew members should not wear, or should at least make invisible to passengers, parts of the operator's cabin crew uniform, such as main jacket or crew signs or badges, that might identify them as members of the operating cabin crew.

CAT.GEN.MPA.120 Common language

The operator shall ensure that all crew members can communicate with each other in a common language.

CAT.GEN.MPA.124 Taxiing of aircraft

The operator shall establish procedures for taxiing of aircraft in order to ensure safe operation and in order to enhance runway safety.

AMC1 CAT.GEN.MPA.124 Taxiing of aircraft**PROCEDURES FOR TAXIING**

Procedures for taxiing should include at least the following:

- (a) application of the sterile flight crew compartment procedures;
- (b) use of standard radio-telephony (RTF) phraseology;
- (c) use of lights;
- (d) measures to enhance the situational awareness of the minimum required flight crew members. The following list of typical items should be adapted by the operator to take into account its operational environment:
 - (1) each flight crew member should have the necessary aerodrome layout charts available;
 - (2) the pilot taxiing the aircraft should announce in advance his/her intentions to the pilot monitoring;
 - (3) all taxi clearances should be heard and should be understood by each flight crew member;
 - (4) all taxi clearances should be cross-checked against the aerodrome chart and aerodrome surface markings, signs, and lights;
 - (5) an aircraft taxiing on the manoeuvring area should stop and hold at all lighted stop bars, and may proceed further when an explicit clearance to enter or cross the runway has been issued by the aerodrome control tower, and when the stop bar lights are switched off;
 - (6) if the pilot taxiing the aircraft is unsure of his/her position, he/she should stop the aircraft and contact air traffic control;
 - (7) the pilot monitoring should monitor the taxi progress and adherence to the clearances, and should assist the pilot taxiing;
 - (8) any action which may disturb the flight crew from the taxi activity should be avoided or done with the parking brake set (e.g. announcements by public address);
- (e) subparagraphs (d)(2) and (d)(7) are not applicable to single-pilot operations.

CAT.GEN.MPA.125 Taxiing of aeroplanes

The operator shall ensure that an aeroplane is only taxied on the movement area of an aerodrome if the person at the controls:

- (a) is an appropriately qualified pilot; or
- (b) has been designated by the operator and:
 - (1) is trained to taxi the aircraft;
 - (2) is trained to use the radio telephone;
 - (3) has received instruction in respect of aerodrome layout, routes, signs, marking, lights, air traffic control (ATC) signals and instructions, phraseology and procedures;
 - (4) is able to conform to the operational standards required for safe aeroplane movement at the aerodrome.

GM1 CAT.GEN.MPA.125 Taxiing of aeroplanes

SKILLS AND KNOWLEDGE

The following skills and knowledge may be assessed to check if a person can be authorised by the operator to taxi an aeroplane:

- (a) positioning of the aeroplane to ensure safety when starting engine;
- (b) getting ATIS reports and taxi clearance, where applicable;
- (c) interpretation of airfield markings/lights/signals/indicators;
- (d) interpretation of marshalling signals, where applicable;
- (e) identification of suitable parking area;
- (f) maintaining lookout and right-of-way rules and complying with air traffic control (ATC) or marshalling instructions, when applicable;
- (g) avoidance of adverse effect of propeller slipstream or jet wash on other aeroplanes, aerodrome facilities and personnel;
- (h) inspection of taxi path when surface conditions are obscured;
- (i) communication with others when controlling an aeroplane on the ground;
- (j) interpretation of operational instructions;
- (k) reporting of any problem that may occur while taxiing an aeroplane; and
- (l) adapting the taxi speed in accordance with prevailing aerodrome, traffic, surface and weather conditions.

GM2 CAT.GEN.MPA.125 Taxiing of aeroplanes

SAFETY-CRITICAL ACTIVITY

- (a) Taxiing should be treated as a safety-critical activity due to the risks related to the movement of the aeroplane and the potential for a catastrophic event on the ground.
- (b) Taxiing is a high-workload phase of flight that requires the full attention of the flight crew.

CAT.GEN.MPA.130 Rotor engagement — helicopters

A helicopter rotor shall only be turned under power for the purpose of flight with a qualified pilot at the controls.

GM1 CAT.GEN.MPA.130 Rotor engagement — helicopters

INTENT OF THE RULE

- (a) The following two situations where it is allowed to turn the rotor under power should be distinguished:
- (1) for the purpose of flight, this is described in the Implementing Rule;
 - (2) for maintenance purposes.
- (b) Rotor engagement for the purpose of flight: the pilot should not leave the control when the rotors are turning. For example, the pilot is not allowed to get out of the aircraft in order to welcome passengers and adjust their seat belts with the rotors turning.
- (c) Rotor engagement for the purpose of maintenance: the Implementing Rule, however, does not prevent ground runs being conducted by qualified personnel other than pilots for maintenance purposes.

The following conditions should be applied:

- (1) the operator should ensure that the qualification of personnel, other than pilots, who are authorised to conduct maintenance runs is described in the appropriate manual;
- (2) ground runs should not include taxiing the helicopter;
- (3) there should be no passengers on board; and
- (4) maintenance runs should not include collective increase or autopilot engagement (due to the risk of ground resonance).

CAT.GEN.MPA.135 Admission to the flight crew compartment

- (a) The operator shall ensure that no person, other than a flight crew member assigned to a flight, is admitted to, or carried in, the flight crew compartment unless that person is:
- (1) an operating crew member;
 - (2) a representative of the competent or inspecting authority, if required to be there for the performance of his/her official duties; or
 - (3) permitted by and carried in accordance with instructions contained in the operations manual.
- (b) The commander shall ensure that:
- (1) admission to the flight crew compartment does not cause distraction or interference with the operation of the flight; and
 - (2) all persons carried in the flight crew compartment are made familiar with the relevant safety procedures.
- (c) The commander shall make the final decision regarding the admission to the flight crew compartment.

AMC1 CAT.GEN.MPA.135(a)(3) Admission to the flight crew compartment

INSTRUCTIONS FOR SINGLE-PILOT OPERATIONS UNDER VFR BY DAY

Where an aircraft is used in a single-pilot operation under visual flight rules (VFR) by day, but has more than one pilot station, the instructions of the operator may permit passengers to be carried in the unoccupied pilot seat(s), provided that the commander is satisfied that:

- (a) it will not cause distraction or interference with the operation of the flight; and
- (b) the passenger occupying a pilot seat is familiar with the relevant restrictions and safety procedures.

CAT.GEN.MPA.140 Portable electronic devices

The operator shall not permit any person to use a portable electronic device (PED) on board an aircraft that could adversely affect the performance of the aircraft's systems and equipment, and shall take all reasonable measures to prevent such use.

AMC1 CAT.GEN.MPA.140 Portable electronic devices

TECHNICAL PREREQUISITES FOR THE USE OF PEDS

(a) Scope

This AMC describes the technical prerequisites under which any kind of portable electronic device (PED) may be used on board the aircraft without adversely affecting the performance of the aircraft's systems and equipment.

(b) Prerequisites concerning the aircraft configuration

- (1) Before an operator may permit the use of any kind of PED on-board, it should ensure that PEDs have no impact on the safe operation of the aircraft. The operator should demonstrate that PEDs do not interfere with on-board electronic systems and equipment, especially with the aircraft's navigation and communication systems.
- (2) The assessment of PED tolerance may be tailored to the different aircraft zones for which the use of PEDs is considered, i.e. may address separately:
 - (i) the passenger compartment;
 - (ii) the flight crew compartment; and
 - (iii) areas not accessible during the flight.

(c) Scenarios for permitting the use of PEDs

- (1) Possible scenarios, under which the operator may permit the use of PEDs, should be as documented in Table 1. The scenarios in Table 1 are listed in a descending order with the least permitting scenario at the bottom.
- (2) Restrictions arising from the corresponding aircraft certification, as documented in the aircraft flight manual (AFM) or equivalent document(s), should stay in force. They may be linked to different aircraft zones, or to particular transmitting technologies covered.
- (3) For Scenarios Nos. 3 to 8 in Table 1 the use of C-PEDs and cargo tracking devices may be further expanded, when the EMI assessment has demonstrated that there is no impact on safety as follows:
 - (i) for C-PEDs by using the method described in (d)(2); and
 - (ii) for cargo tracking devices by using the method described in (d)(3).

Table 1 – Scenarios for permitting the use of PEDs by the operator

No.	Technical condition	Non-intentional transmitters	T-PEDs
1	The aircraft is certified as T-PED tolerant, i.e. it has been demonstrated during the aircraft certification process that front door and back door coupling have no impact on the	All phases of flight	All phases of flight

No.	Technical condition	Non-intentional transmitters	T-PEDs
	safe operation of the aircraft		
2	A complete electromagnetic interference (EMI) assessment for all technologies, using the method described in (d)(1), has been performed and has demonstrated the T-PED tolerance	All phases of flight	All phases of flight
3	The aircraft is certified for the use of T-PEDs using particular technologies (e.g. WLAN or mobile phone)	All phases of flight	All phases of flight, restricted to those particular technologies
4	The EMI assessment, using the method described in (d)(1), has demonstrated that: (a) the front door coupling has no impact on safety; and (b) the back door coupling has no impact on safety when using particular technologies (e.g. WLAN or mobile phone)	All phases of flight	All phases of flight, restricted to those particular technologies
5	The EMI assessment, using the method described in (d)(1)(i), has demonstrated that the front door coupling has no impact on safety caused by non-intentional transmitters	All phases of flight	Not permitted
6	The EMI assessment, using the method described in (d)(1)(ii), has demonstrated that the back door coupling has no impact on safety when using particular technologies (e.g. WLAN or mobile phone)	All phases of flight - except low visibility approach operation	All phases of flight - except low visibility approach operation, restricted to those particular technologies
7	An EMI assessment has not been performed	All phases of flight - except low visibility approach operation	Not permitted
8	Notwithstanding Scenarios Nos. 3 to 7	(a) before taxi-out; (b) during taxi-in after the end of landing roll; and (c) the commander may permit the use during prolonged departure delays, provided that sufficient time is available to check the passenger compartment	

No.	Technical condition	Non-intentional transmitters	T-PEDs
		before the flight proceeds	

(d) Demonstration of electromagnetic compatibility

(1) EMI assessment at aircraft level

The means to demonstrate that the radio frequency (RF) emissions (intentional or non-intentional) are tolerated by aircraft systems should be as follows:

(i) to address front door coupling susceptibility for any kind of PEDs:

- (A) RTCA, 'Guidance on allowing transmitting portable, electronic devices (T-PEDs) on aircraft', DO-294C (or later revisions), Appendix 5C; or
- (B) RTCA, 'Aircraft design and certification for portable electronic device (PED) tolerance', DO-307 (including Change 1 or later revisions), Section 4; and

(ii) to address back door coupling susceptibility for T-PEDs:

- (A) EUROCAE, 'Guidance for the use of portable electronic devices (PEDs) on board aircraft', ED-130 (or later revisions), Annex 6;
- (B) RTCA DO-294C (or later revisions), Appendix 6D; or
- (C) RTCA DO-307 (including Change 1 or later revisions), Section 3.

(2) Alternative EMI assessment of C-PEDs

(i) For front door coupling:

(A) C-PEDs should comply with the levels as defined by:

- (a) EUROCAE/RTCA, 'Environmental conditions and test procedures for airborne equipment', ED-14D/DO-160D (or later revisions), Section 21, Category M, for operation in the passenger compartment and the flight crew compartment; and
 - (b) EUROCAE ED-14E/RTCA DO-160E (or later revisions), Section 21, Category H, for operation in areas not accessible during the flight.
- (B) If the C-PEDs are electronic flight bags used in the flight crew compartment, an alternative compliance method described in EASA, 'General acceptable means of compliance for airworthiness of products, part and appliances', AMC-20, AMC 20-25 ('Airworthiness and operational considerations for electronic flight bags'), may be used.

(ii) For back door coupling the EMI assessment described in (1)(ii) should be performed.

(3) Alternative EMI assessment of cargo tracking devices

In case a transmitting function is automatically deactivated in a cargo tracking device (being a T-PED), the unit should be qualified for safe operation on board the aircraft. One of the following methods should be considered acceptable as evidence for safe operation:

- (i) A type-specific safety assessment, including failure mode and effects analysis, has been performed at aircraft level. The main purpose of the assessment should be to determine the worst hazards and to demonstrate an adequate design assurance level of the relevant hardware and software components of the cargo tracking device.

- (ii) The high intensity radiated field (HIRF) certification of the aircraft has been performed, i.e. the aircraft type has been certified after 1987 and meets the appropriate special condition. In such a case, the operator should observe the following:
 - (A) The tracking device:
 - (a) features an automated and prolonged radio suspension in flight using multiple modes of redundancy; and
 - (b) has been verified in the aircraft environment to ensure deactivation of the transmitting function in flight.
 - (B) The transmissions of the tracking device are limited per design to short periods of time (less than 1 second per 1 000 seconds) and cannot be continuous.
 - (C) The tracking device emissions should comply with the levels as defined by EUROCAE ED-14E/RTCA DO-160E (or later revisions), Section 21, Category H.
 - (D) In order to provide assurance on the tracking device design and production, the following documents are retained as part of the evaluation package:
 - (a) operational description, technical specifications, product label and images of the tracking device and any peripheral attachments;
 - (b) failure mode and effects analysis report of the tracking device and any peripheral attachments;
 - (c) declaration of stringent design and production controls in place during the tracking device manufacturing;
 - (d) declaration of conformity and technical documentation showing compliance to the European Norms (EN), regulating the transmitter characteristic of the tracking device or its transmission module; and
 - (e) an EMI assessment report documenting the emission levels.
 - (iii) The tracking device interference levels during transmission are below those considered acceptable for the specific aircraft environment.
- (e) Operational conditions of C-PEDs and cargo tracking devices
- The operator should ensure that C-PEDs and cargo tracking devices are maintained in good and safe condition, having in mind that:
- (1) damage may modify their emissions characteristics; and
 - (2) damage to the battery may create a fire hazard.
- (f) Batteries in C-PEDs and cargo tracking devices
- Lithium-type batteries in C-PEDs and cargo tracking devices should meet:
- (1) United Nations (UN) Transportation Regulations, 'Recommendations on the transport of dangerous goods - manual of tests and criteria', UN ST/SG/AC.10/11; and
 - (2) one of the following standards:
 - (i) Underwriters Laboratory, 'Lithium batteries', UL 1642;
 - (ii) Underwriters Laboratory, 'Household and commercial batteries', UL 2054;
 - (iii) Underwriters Laboratory, 'Information technology equipment – safety', UL 60950-1;

- (iv) International Electrotechnical Commission (IEC), ‘Secondary cells and batteries containing alkaline or other non-acid electrolytes - safety requirements for portable sealed secondary cells, and for batteries made from them, for use in portable applications’, IEC 62133;
- (v) RTCA, ‘Minimum operational performance standards for rechargeable lithium battery systems’, DO-311. RTCA DO-311 may be used to address concerns regarding overcharging, over-discharging, and the flammability of cell components. The standard is intended to test permanently installed equipment; however, these tests are applicable and sufficient to test electronic flight bags rechargeable lithium-type batteries; or
- (vi) European Technical Standard Order (ETSO), ‘Non-rechargeable lithium cells and batteries’, ETSO C142a.

AMC2 CAT.GEN.MPA.140 Portable electronic devices

PROCEDURES FOR THE USE OF PEDS

(a) Scope

This AMC describes the procedures under which any kind of portable electronic device (PED) may be used on board the aircraft without adversely affecting the performance of the aircraft’s systems and equipment. This AMC addresses the operation of PEDs in the different aircraft zones — passenger compartment, flight compartment, and areas inaccessible during the flight.

(b) Prerequisites

Before permitting the use of any kind of PEDs the operator should ensure compliance with (c) of AMC1 CAT.GEN.MPA.140.

(c) Hazard identification and risk assessment

The operator should identify the safety hazards and manage the associated risks following the management system implemented in accordance with ORO.GEN.200. The risk assessment should include hazards associated with:

- (1) PEDs in different aircraft zones;
- (2) PED use during various phases of flight;
- (3) PED use during turbulence;
- (4) improperly stowed PEDs;
- (5) impeded or slowed evacuations;
- (6) passenger non-compliance, e.g. not deactivating transmitting functions, not switching off PEDs or not stowing PEDs properly;
- (7) disruptive passengers; and
- (8) battery fire.

(d) Use of PEDs in the passenger compartment

(1) Procedures and training

If an operator permits passengers to use PEDs on board its aircraft, procedures should be in place to control their use. These procedures should include provisions for passenger briefing, passenger handling and for the stowage of PEDs. The operator should ensure that all crew

members and ground personnel are trained to enforce possible restrictions concerning the use of PEDs, in line with these procedures.

- (2) Provisions for use
 - (i) The use of PEDs in the passenger compartment may be granted under the responsibility of the operator, i.e. the operator decides which PED may be used during which phases of the flight.
 - (ii) Notwithstanding (b), medical equipment necessary to support physiological functions may be used at all times and does not need to be switched-off.
- (3) Stowage, passenger information and passenger briefing of PEDs
 - (i) In accordance with CAT.OP.MPA.160 the operator should establish procedures concerning the stowage of PEDs. The operator should:
 - (A) identify the phases of flight in which PEDs are to be stowed; and
 - (B) determine suitable stowage locations, taking into account the PEDs' size and weight.
 - (ii) The operator should provide general information on the use of PEDs to the passengers before the flight. This information should specify at least:
 - (A) which PEDs can be used during which phases of the flight;
 - (B) when and where PEDs are to be stowed; and
 - (C) that the instructions of the crew are to be followed at all times.
 - (iii) In accordance with CAT.OP.MPA.170, the use of PEDs should be part of the passenger briefings. The operator should remind passengers to pay attention and to avoid distraction during such briefings.
- (4) In-seat electrical power supplies

Where in-seat electrical power supplies are available for passenger use, the following should apply:

 - (i) information giving safety instructions should be provided to the passengers;
 - (ii) PEDs should be disconnected from any in-seat electrical power supply during taxiing, take-off, approach, landing, and during abnormal or emergency conditions; and
 - (iii) flight crew, cabin crew and technical crew should be aware of the proper means to switch-off in-seat power supplies used for PEDs.
- (5) Operator's safety measures during boarding and any phase of flight
 - (i) Appropriate coordination between flight crew, cabin crew and technical crew should be established to deal with interference or other safety problems associated with PEDs.
 - (ii) Suspect equipment should be switched off.
 - (iii) Particular attention should be given to passenger misuse of equipment.
 - (iv) Thermal runaways of batteries, in particular lithium batteries, and potential resulting fire, should be handled properly.
 - (v) The commander may, for any reason and during any phase of flight, require deactivation and stowage of PEDs.

- (vi) When the operator restricts the use of PEDs, consideration should be given to handle special requests to operate a T-PED during any phase of the flight for specific reasons (e.g. for security measures).
- (6) Reporting

Occurrences of suspected or confirmed interference should be reported to the competent authority. Where possible, to assist follow-up and technical investigation, reports should describe the suspected device, identify the brand name and model number, its location in the aircraft at the time of the occurrence, interference symptoms, the device user's contact details and the results of actions taken by the crew.
- (e) Use of PEDs in the flight crew compartment

In the flight crew compartment the operator may permit the use of PEDs, e.g. to assist the flight crew in their duties, when procedures are in place to ensure the following:

 - (1) The conditions for the use of PEDs in-flight are specified in the operations manual.
 - (2) The PEDs do not pose a loose item risk or other hazard.
 - (3) These provisions should not preclude use of a T-PED (specifically a mobile phone) by the flight crew to deal with an emergency. However, reliance should not be predicated on a T-PED for this purpose.
- (f) PEDs not accessible during the flight

PEDs should be switched off, when not accessible for deactivation during flight. This should apply especially to PEDs contained in baggage or transported as part of the cargo. The operator may permit deviation for PEDs for which safe operation has been demonstrated in accordance with AMC1 CAT.GEN.MPA.140. Other precautions, such as transporting in shielded metal boxes, may also be used to mitigate associated risks.

GM1 CAT.GEN.MPA.140 Portable electronic devices

DEFINITIONS

(a) Definition and categories of PEDs

PEDs are any kind of electronic device, typically but not limited to consumer electronics, brought on board the aircraft by crew members, passengers, or as part of the cargo and that are not included in the approved aircraft configuration. All equipment that is able to consume electrical energy falls under this definition. The electrical energy can be provided from internal sources as batteries (chargeable or non-rechargeable) or the devices may also be connected to specific aircraft power sources.

PEDs include the following two categories:

- (1) Non-intentional transmitters can non-intentionally radiate RF transmissions, sometimes referred to as spurious emissions. This category includes, but is not limited to, calculators, cameras, radio receivers, audio and video players, electronic games and toys; when these devices are not equipped with a transmitting function.
- (2) Intentional transmitters radiate RF transmissions on specific frequencies as part of their intended function. In addition, they may radiate non-intentional transmissions like any PED. The term 'transmitting PED' (T-PED) is used to identify the transmitting capability of the PED. Intentional transmitters are transmitting devices such as RF-based remote control equipment, which may include some toys, two-way radios (sometimes referred to as 'private mobile radio'), mobile phones of any type, satellite phones, computers with mobile

phone data connection, wireless local area network (WLAN) or Bluetooth capability. After deactivation of the transmitting capability, e.g. by activating the so-called 'flight mode' or 'flight safety mode', the T-PED remains a PED having non-intentional emissions.

(b) Controlled PEDs (C-PEDs)

A controlled PED (C-PED) is a PED subject to administrative control by the operator using it. This will include, inter alia, tracking the allocation of the devices to specific aircraft or persons and ensuring that no unauthorised changes are made to the hardware, software or databases. C-PEDs can be assigned to the category of non-intentional transmitters or T-PEDs.

(c) Cargo tracking device

A cargo tracking device is a PED attached to or included in airfreight (e.g. in or on containers, pallets, parcels or baggage). Cargo tracking devices can be assigned to the category of non-intentional transmitters or T-PEDs. If the device is a T-PED, it complies with the European Norms (EN) for transmissions.

(d) Definition of the switched-off status

Many PEDs are not completely disconnected from the internal power source when switched off. The switching function may leave some remaining functionality e.g. data storage, timer, clock, etc. These devices can be considered switched off when in the deactivated status. The same applies to devices having no transmitting capability and are operated by coin cells without further deactivation capability, e.g. wrist watches.

(e) Electromagnetic interference (EMI)

The two classes of EMI to be addressed can be described as follows:

- (1) Front door coupling is the possible disturbance to an aircraft system as received by the antenna of the system and mainly in the frequency band used by the system. Any PED internal oscillation has the potential to radiate low level signals in the aviation frequency bands. Through this disturbance especially the instrument landing system (ILS) and the VHF omni range (VOR) navigation system may indicate erroneous information.
- (2) Back door coupling is the possible disturbance of aircraft systems by electromagnetic fields generated by transmitters at a level which could exceed on short distance (i.e. within the aircraft) the electromagnetic field level used for the aircraft system certification. This disturbance may then lead to system malfunction.

GM2 CAT.GEN.MPA.140 Portable electronic devices

CREW REST COMPARTMENT, NAVIGATION, TEST ENTITIES AND FIRE CAUSED BY PEDS

- (a) When the aircraft is equipped with a crew rest compartment, it is considered being part of the passenger compartment.
- (b) Front door coupling may influence the VOR navigation system. Therefore, the flight crew monitors other navigation sensors to detect potential disturbances by PEDs, especially during low visibility departure operation based on VOR guidance.
- (c) Specific equipment, knowledge and experience are required, when the industry standards for evaluating technical prerequisites for the use of PEDs are applied. In order to ensure conformity with the industry standards, the operator is encouraged to cooperate with an appropriately qualified and experienced entity, as necessary. For this entity an aviation background is not required, but is considered to be beneficial.

- (d) Guidance to follow in case of fire caused by PEDs is provided by the International Civil Aviation Organisation, 'Emergency response guidance for aircraft incidents involving dangerous goods', ICAO Doc 9481-AN/928.

GM3 CAT.GEN.MPA.140 Portable electronic devices

CARGO TRACKING DEVICES EVALUATION

- (a) Safety assessment

Further guidance on performing a safety assessment can be found in:

- (1) EASA, 'Certification specifications and acceptable means of compliance for large aeroplanes', CS-25, Book 2, AMC-Subpart F, AMC 25.1309;
- (2) EUROCAE/SAE, 'Guidelines for development of civil aircraft and systems', ED-79/ARP 4754 (or later revisions); and
- (3) SAE, 'Guidelines and methods for conducting the safety assessment process on civil airborne systems and equipment', ARP 4761 (or later revisions).

- (b) HIRF certification

The type certificate data sheet (TCDS), available on the EASA website for each aircraft model having EASA certification, lists whether the HIRF certification has been performed through a special condition. The operator may contact the type certification holder to gain the necessary information.

- (c) Failure mode and effects analysis

Further guidance on performing a failure mode and effects analysis can be found in:

- (1) SAE ARP 4761 (or later revisions); and
- (2) U.S. Department of Defense, 'Procedures for performing a failure mode, effects and criticality analysis', Military Standard MIL-STD-1629A (or later revisions).

CAT.GEN.MPA.145 Information on emergency and survival equipment carried

The operator shall at all times have available for immediate communication to rescue coordination centres (RCCs) lists containing information on the emergency and survival equipment carried on board any of their aircraft.

AMC1 CAT.GEN.MPA.145 Information on emergency and survival equipment carried

ITEMS FOR COMMUNICATION TO THE RESCUE COORDINATION CENTRE

The information, compiled in a list, should include, as applicable, the number, colour and type of life rafts and pyrotechnics, details of emergency medical supplies, e.g. first-aid kits, emergency medical kits, water supplies and the type and frequencies of emergency portable radio equipment.

CAT.GEN.MPA.150 Ditching — aeroplanes

The operator shall only operate an aeroplane with a passenger seating configuration of more than 30 on overwater flights at a distance from land suitable for making an emergency landing, greater than 120 minutes at cruising speed, or 400 NM, whichever is less, if the aeroplane complies with the ditching provisions prescribed in the applicable airworthiness code.

CAT.GEN.MPA.155 Carriage of weapons of war and munitions of war

- (a) The operator shall only transport weapons of war or munitions of war by air if an approval to do so has been granted by all States whose airspace is intended to be used for the flight.
- (b) Where an approval has been granted, the operator shall ensure that weapons of war and munitions of war are:
 - (1) stowed in the aircraft in a place that is inaccessible to passengers during flight; and
 - (2) in the case of firearms, unloaded.
- (c) The operator shall ensure that, before a flight begins, the commander is notified of the details and location on board the aircraft of any weapons of war and munitions of war intended to be carried.

GM1 CAT.GEN.MPA.155 Carriage of weapons of war and munitions of war**WEAPONS OF WAR AND MUNITIONS OF WAR**

- (a) In accordance with Regulation (EC) No 300/2008, weapons of war may be carried on board an aircraft, in a place that is not inaccessible, if the required security conditions in accordance with national laws have been fulfilled and authorisation has been given by the States involved.
- (b) There is no internationally agreed definition of weapons of war and munitions of war. Some States may have defined them for their particular purposes or for national need.
- (c) It is the responsibility of the operator to check, with the State(s) concerned, whether or not a particular weapon or munition is regarded as a weapon of war or munitions of war. In this context, States that may be concerned with granting approvals for the carriage of weapons of war or munitions of war are those of origin, transit, overflight and destination of the consignment and the State of the operator.
- (d) Where weapons of war or munitions of war are also dangerous goods by definition (e.g. torpedoes, bombs, etc.), CAT.GEN.MPA.200 Transport of dangerous goods also applies.

CAT.GEN.MPA.160 Carriage of sporting weapons and ammunition

- (a) The operator shall take all reasonable measures to ensure that any sporting weapons intended to be carried by air are reported to the operator.
- (b) The operator accepting the carriage of sporting weapons shall ensure that they are:
 - (1) stowed in the aircraft in a place that is inaccessible to passengers during flight; and
 - (2) in the case of firearms or other weapons that can contain ammunition, unloaded.
- (c) Ammunition for sporting weapons may be carried in passengers' checked baggage, subject to certain limitations, in accordance with the technical instructions.

GM1 CAT.GEN.MPA.160 Carriage of sporting weapons and ammunition

SPORTING WEAPONS

- (a) In accordance with Regulation (EC) No 300/2008 sporting weapons may be carried on board an aircraft, in a place that is not inaccessible, if the required security conditions in accordance with national laws have been fulfilled and authorisation has been given by the States involved.
- (b) There is no internationally agreed definition of sporting weapons. In general, it may be any weapon that is not a weapon of war or munitions of war. Sporting weapons include hunting knives, bows and other similar articles. An antique weapon, which at one time may have been a weapon of war or munitions of war, such as a musket, may now be regarded as a sporting weapon.
- (c) A firearm is any gun, rifle or pistol that fires a projectile.
- (d) The following firearms are generally regarded as being sporting weapons:
 - (1) those designed for shooting game, birds and other animals;
 - (2) those used for target shooting, clay-pigeon shooting and competition shooting, providing the weapons are not those on standard issue to military forces; and
 - (3) airguns, dart guns, starting pistols, etc.
- (e) A firearm, which is not a weapon of war or munitions of war, should be treated as a sporting weapon for the purposes of its carriage on an aircraft.

CAT.GEN.MPA.161 Carriage of sporting weapons and ammunition — alleviations

Notwithstanding CAT.GEN.MPA.160(b), for helicopters with a maximum certified take-off mass (MCTOM) of 3 175 kg or less operated by day and over routes navigated by reference to visual landmarks, a sporting weapon may be carried in a place that is accessible during flight, provided that the operator has established appropriate procedures and it is impracticable to stow it in an inaccessible stowage during flight.

AMC1 CAT.GEN.MPA.161 Carriage of sporting weapons and ammunition — alleviations**SPORTING WEAPONS — HELICOPTERS**

Procedures for the carriage of sporting weapons may need to be considered if the helicopter does not have a separate compartment in which the weapons can be stowed. These procedures should take into account the nature of the flight, its origin and destination, and the possibility of unlawful interference. As far as possible, the weapons should be stowed so they are not immediately accessible to the passengers, e.g. in locked boxes, in checked baggage that is stowed under other baggage or under fixed netting.

CAT.GEN.MPA.165 Method of carriage of persons

The operator shall take all measures to ensure that no person is in any part of an aircraft in flight that is not designed for the accommodation of persons unless temporary access has been granted by the commander:

- (a) for the purpose of taking action necessary for the safety of the aircraft or of any person, animal or goods therein; or
- (b) to a part of the aircraft in which cargo or supplies are carried, being a part that is designed to enable a person to have access thereto while the aircraft is in flight.

CAT.GEN.MPA.170 Alcohol and drugs

The operator shall take all reasonable measures to ensure that no person enters or is in an aircraft when under the influence of alcohol or drugs to the extent that the safety of the aircraft or its occupants is likely to be endangered.

CAT.GEN.MPA.175 Endangering safety

The operator shall take all reasonable measures to ensure that no person recklessly or negligently acts or omits to act so as to:

- (a) endanger an aircraft or person therein; or
- (b) cause or permit an aircraft to endanger any person or property.

CAT.GEN.MPA.180 Documents, manuals and information to be carried

- (a) The following documents, manuals and information shall be carried on each flight, as originals or copies unless otherwise specified:
 - (1) the aircraft flight manual (AFM), or equivalent document(s);
 - (2) the original certificate of registration;
 - (3) the original certificate of airworthiness (CofA);
 - (4) the noise certificate, including an English translation, where one has been provided by the authority responsible for issuing the noise certificate;
 - (5) a certified true copy of the air operator certificate (AOC), including an English translation when the AOC has been issued in another language;
 - (6) the operations specifications relevant to the aircraft type, issued with the AOC, including an English translation when the operations specifications have been issued in another language;
 - (7) the original aircraft radio licence, if applicable;
 - (8) the third party liability insurance certificate(s);
 - (9) the journey log, or equivalent, for the aircraft;
 - (10) the aircraft technical log, in accordance with Annex I (Part-M) to Regulation (EC) No 2042/2003;
 - (11) details of the filed ATS flight plan, if applicable;
 - (12) current and suitable aeronautical charts for the route of the proposed flight and all routes along which it is reasonable to expect that the flight may be diverted;

- (13) procedures and visual signals information for use by intercepting and intercepted aircraft;
 - (14) information concerning search and rescue services for the area of the intended flight, which shall be easily accessible in the flight crew compartment;
 - (15) the current parts of the operations manual that are relevant to the duties of the crew members, which shall be easily accessible to the crew members;
 - (16) the MEL;
 - (17) appropriate notices to airmen (NOTAMs) and aeronautical information service (AIS) briefing documentation;
 - (18) appropriate meteorological information;
 - (19) cargo and/or passenger manifests, if applicable;
 - (20) mass and balance documentation;
 - (21) the operational flight plan, if applicable;
 - (22) notification of special categories of passenger (SCPs) and special loads, if applicable; and
 - (23) any other documentation that may be pertinent to the flight or is required by the States concerned with the flight.
- (b) Notwithstanding (a), for operations under visual flight rules (VFR) by day with other-than complex motor-powered aircraft taking off and landing at the same aerodrome or operating site within 24 hours, or remaining within a local area specified in the operations manual, the following documents and information may be retained at the aerodrome or operating site instead:
- (1) noise certificate;
 - (2) aircraft radio licence;
 - (3) journey log, or equivalent;
 - (4) aircraft technical log;
 - (5) NOTAMs and AIS briefing documentation;
 - (6) meteorological information;
 - (7) notification of SCPs and special loads, if applicable; and
 - (8) mass and balance documentation.
- (c) Notwithstanding (a), in case of loss or theft of documents specified in (a)(2) to (a)(8), the operation may continue until the flight reaches its destination or a place where replacement documents can be provided.

AMC1 CAT.GEN.MPA.180 Documents, manuals and information to be carried**GENERAL**

The documents, manuals and information may be available in a form other than on printed paper. Accessibility, usability and reliability should be assured.

GM1 CAT.GEN.MPA.180(a)(1) Documents, manuals and information to be carried

AIRCRAFT FLIGHT MANUAL OR EQUIVALENT DOCUMENT(S)

‘Aircraft flight manual, or equivalent document(s)’ means in the context of this rule the flight manual for the aircraft, or other documents containing information required for the operation of the aircraft within the terms of its certificate of airworthiness unless these data are available in the parts of the operations manual carried on board.

GM1 CAT.GEN.MPA.180(a)(5)(6) Documents, manuals and information to be carried

CERTIFIED TRUE COPIES

- (a) Certified true copies may be provided:
- (1) directly by the competent authority; or
 - (2) by persons holding privileges for certification of official documents in accordance with the applicable Member State’s legislation, e.g. public notaries, authorised officials in public services.
- (b) Translations of the air operator certificate (AOC) including operations specifications do not need to be certified.

GM1 CAT.GEN.MPA.180(a)(9) Documents, manuals and information to be carried

JOURNEY LOG OR EQUIVALENT

‘Journey log, or equivalent’ means that the required information may be recorded in documentation other than a log book, such as the operational flight plan or the aircraft technical log.

AMC1 CAT.GEN.MPA.180(a)(13) Documents, manuals and information to be carried

PROCEDURES AND VISUAL SIGNALS FOR USE BY INTERCEPTING AND INTERCEPTED AIRCRAFT

The procedures and the visual signals information for use by intercepting and intercepted aircraft should reflect those contained in International Civil Aviation Organization (ICAO) Annex 2. This may be part of the operations manual.

GM1 CAT.GEN.MPA.180(a)(14) Documents, manuals and information to be carried

SEARCH AND RESCUE INFORMATION

This information is usually found in the State’s aeronautical information publication.

GM1 CAT.GEN.MPA.180(a)(23) Documents, manuals and information to be carried

DOCUMENTS THAT MAY BE PERTINENT TO THE FLIGHT

Any other documents that may be pertinent to the flight or required by the States concerned with the flight, may include, for example, forms to comply with reporting requirements.

STATES CONCERNED WITH THE FLIGHT

The States concerned are those of origin, transit, overflight and destination of the flight.

CAT.GEN.MPA.185 Information to be retained on the ground

- (a) The operator shall ensure that at least for the duration of each flight or series of flights:
- (1) information relevant to the flight and appropriate for the type of operation is preserved on the ground;
 - (2) the information is retained until it has been duplicated at the place at which it will be stored; or, if this is impracticable
 - (3) the same information is carried in a fireproof container in the aircraft.
- (b) The information referred to in (a) includes:
- (1) a copy of the operational flight plan, where appropriate;
 - (2) copies of the relevant part(s) of the aircraft technical log;
 - (3) route-specific NOTAM documentation if specifically edited by the operator;
 - (4) mass and balance documentation if required; and
 - (5) special loads notification.

CAT.GEN.MPA.190 Provision of documentation and records

The commander shall, within a reasonable time of being requested to do so by a person authorised by an authority, provide to that person the documentation required to be carried on board.

CAT.GEN.MPA.195 Handling of flight recorder recordings: preservation, production, protection and use

- (a) Following an accident, a serious incident or an occurrence identified by the investigating authority, the operator of an aircraft shall preserve the original recorded data for a period of 60 days or until otherwise directed by the investigating authority.
- (b) The operator shall conduct operational checks and evaluations of flight data recorder (FDR) recordings, cockpit voice recorder (CVR) recordings and data link recordings to ensure the continued serviceability of the recorders.
- (c) The operator shall save the recordings for the period of operating time of the FDR as required by CAT.IDE.A.190 or CAT.IDE.H.190, except that, for the purpose of testing and maintaining the FDR, up to one hour of the oldest recorded material at the time of testing may be erased.
- (d) The operator shall keep and maintain up-to-date documentation that presents the necessary information to convert FDR raw data into parameters expressed in engineering units.
- (e) The operator shall make available any flight recorder recording that has been preserved, if so determined by the competent authority.
- (f) Without prejudice to Regulation (EU) No 996/2010 of the European Parliament and of the Council²:
- (1) Except for ensuring the CVR serviceability, CVR recordings shall not be disclosed or used unless:

² OJ L 295, 12.11.2010, p. 35.

- (i) a procedure related to the handling of CVR recordings and of their transcript is in place;
 - (ii) all crew members and maintenance personnel concerned have given their prior consent; and
 - (iii) they are used only for maintaining or improving safety.
- (1a) When a CVR recording is inspected for ensuring the CVR serviceability, the operator shall ensure the privacy of the CVR recording and the CVR recording shall not be disclosed or used for other purposes than ensuring the CVR serviceability.
- (2) FDR recordings or data link recordings shall only be used for purposes other than for the investigation of an accident or an incident which is subject to mandatory reporting, if such records are:
- (i) used by the operator for airworthiness or maintenance purposes only; or
 - (ii) de-identified; or
 - (iii) disclosed under secure procedures.

AMC1 CAT.GEN.MPA.195(a) Handling of flight recorder recordings: preservation, production, protection and use**PRESERVATION OF RECORDED DATA FOR INVESTIGATION**

- (a) The operator should establish procedures to ensure that flight recorder recordings are preserved for the investigating authority.
- (b) These procedures should include:
- (1) instructions for flight crew members to deactivate the flight recorders immediately after completion of the flight and inform relevant personnel that the recording of the flight recorders should be preserved. These instructions should be readily available on board; and
 - (2) instructions to prevent inadvertent reactivation, test, repair or reinstallation of the flight recorders by operator personnel or during maintenance or ground handling activities performed by third parties.

GM1 CAT.GEN.MPA.195(a) Handling of flight recorder recordings: preservation, production, protection and use**REMOVAL OF RECORDERS IN CASE OF AN INVESTIGATION**

The need for removal of the recorders from the aircraft is determined by the investigating authority with due regard to the seriousness of an occurrence and the circumstances, including the impact on the operation.

AMC1 CAT.GEN.MPA.195(b) Handling of flight recorder recordings: preservation, production, protection and use**INSPECTIONS AND CHECKS OF RECORDINGS**

Whenever a flight recorder is required to be carried:

- (a) the operator should perform an inspection of the FDR recording and the CVR recording every year unless one or more of the following applies:

- (1) If the flight recorder records on magnetic wire or uses frequency modulation technology, the time interval between two inspections of the recording should not exceed three months.
 - (2) If the flight recorder is solid-state and the flight recorder system is fitted with continuous monitoring for proper operation, the time interval between two inspections of the recording may be up to two years.
 - (3) In the case of an aircraft equipped with two solid-state flight data and cockpit voice combination recorders, where
 - (i) the flight recorder systems are fitted with continuous monitoring for proper operation, and
 - (ii) the flight recorders share the same flight data acquisition,a comprehensive inspection of the recording needs only to be performed for one flight recorder position. The inspection of the recordings should be performed alternately so that each flight recorder position is inspected at time intervals not exceeding four years.
 - (4) Where all of the following conditions are met, the inspection of the FDR recording is not needed:
 - (i) the aircraft flight data are collected in the frame of a flight data monitoring (FDM) programme;
 - (ii) the data acquisition of mandatory flight parameters is the same for the FDR and for the recorder used for the FDM programme;
 - (iii) an inspection similar to the inspection of the FDR recording and covering all mandatory flight parameters is conducted on the FDM data at time intervals not exceeding two years; and
 - (iv) the FDR is solid-state and the FDR system is fitted with continuous monitoring for proper operation.
- (b) the operator should perform every five years an inspection of the data link recording;
- (c) when installed, the aural or visual means for preflight checking the flight recorders for proper operation should be used every day. When no such means is available for a flight recorder, the operator should perform an operational check of this flight recorder at time intervals not exceeding seven calendar days of operation.
- (d) the operator should check every five years, or in accordance with the recommendations of the sensor manufacturer, that the parameters dedicated to the FDR and not monitored by other means are being recorded within the calibration tolerances and that there is no discrepancy in the engineering conversion routines for these parameters.

GM1 CAT.GEN.MPA.195(b) Handling of flight recorder recordings: preservation, production, protection and use

INSPECTION OF THE FLIGHT RECORDERS RECORDING

- (a) The inspection of the FDR recording usually consists of the following:
- (1) Making a copy of the complete recording file.
 - (2) Converting the recording to parameters expressed in engineering units in accordance with the documentation required to be held.

- (3) Examining a whole flight in engineering units to evaluate the validity of all mandatory parameters — this could reveal defects or noise in the measuring and processing chains and indicate necessary maintenance actions. The following should be considered:
 - (i) when applicable, each parameter should be expressed in engineering units and checked for different values of its operational range — for this purpose, some parameters may need to be inspected at different flight phases; and
 - (ii) if the parameter is delivered by a digital data bus and the same data are utilised for the operation of the aircraft, then a reasonableness check may be sufficient; otherwise a correlation check may need to be performed:
 - (A) a reasonableness check is understood in this context as a subjective, qualitative evaluation, requiring technical judgement, of the recordings from a complete flight; and
 - (B) a correlation check is understood in this context as the process of comparing data recorded by the flight data recorder against the corresponding data derived from flight instruments, indicators or the expected values obtained during specified portion(s) of a flight profile or during ground checks that are conducted for that purpose.
 - (4) Retaining the most recent copy of the complete recording file and the corresponding recording inspection report that includes references to the documentation required to be held.
- (b) When performing the CVR recording inspection, precautions need to be taken to comply with CAT.GEN.MPA.195(f)(1a). The inspection of the CVR recording usually consists of:
- (1) checking that the CVR operates correctly for the nominal duration of the recording;
 - (2) examining, where practicable, a sample of in-flight recording of the CVR for evidence that the signal is acceptable on each channel; and
 - (3) preparing and retaining an inspection report.
- (c) The inspection of the DLR recording usually consists of:
- (1) Checking the consistency of the data link recording with other recordings for example, during a designated flight, the flight crew speaks out a few data link messages sent and received. After the flight, the data link recording and the CVR recording are compared for consistency.
 - (2) Retaining the most recent copy of the complete recording and the corresponding inspection report.

GM2 CAT.GEN.MPA.195(b) Handling of flight recorder recordings: preservation, production, protection and use

MONITORING AND CHECKING THE PROPER OPERATION OF FLIGHT RECORDERS — EXPLANATION OF TERMS

For the understanding of the terms used in AMC1 CAT.GEN.MPA.195(b):

- (a) ‘operational check of the flight recorder’ means a check of the flight recorder for proper operation. It is not a check of the quality of the recording and, therefore, it is not equivalent to an inspection of the recording. This check can be carried out by the flight crew or through a maintenance task.

- (b) ‘aural or visual means for preflight checking the flight recorders for proper operation’ means an aural or visual means for the flight crew to check before the flight the results of an automatically or manually initiated test of the flight recorders for proper operation. Such a means provides for an operational check that can be performed by the flight crew.
- (c) ‘flight recorder system’ means the flight recorder, its dedicated sensors and transducers, as well as its dedicated acquisition and processing equipment.
- (d) ‘continuous monitoring for proper operation’ means for a flight recorder system, a combination of system monitors and/or built-in test functions which operates continuously in order to detect the following:
- (1) loss of electrical power supply to the flight recorder system;
 - (2) failure of the equipment performing acquisition and processing;
 - (3) failure of the recording medium and/or drive mechanism; and
 - (4) failure of the recorder to store the data in the recording medium as shown by checks of the recorded data including, as reasonably practicable for the storage medium concerned, correct correspondence with the input data.

However, detections by the continuous monitoring for proper operation do not need to be automatically reported to the flight crew compartment.

GM3 CAT.GEN.MPA.195(b) Handling of flight recorder recordings: preservation, production, protection and use

CVR AUDIO QUALITY

Examples of CVR audio quality issues and possible causes thereof may be found in the document of the French Bureau d’Enquêtes et d’Analyses, titled ‘Study on detection of audio anomalies on CVR recordings’ and dated September 2015³.

AMC1 CAT.GEN.MPA.195(f)(1) Handling of flight recorder recordings: preservation, production, protection and use

USE OF CVR RECORDINGS FOR MAINTAINING OR IMPROVING SAFETY

- (a) The procedure related to the handling of cockpit voice recorder (CVR) recordings should be written in a document which should be signed by all parties (airline management, crew member representatives nominated either by the union or the crew themselves, maintenance personnel representatives if applicable). This procedure should, as a minimum, define:
- (1) the method to obtain the consent of all crew members and maintenance personnel concerned;
 - (2) an access and security policy that restricts access to CVR recordings and identified CVR transcripts to specifically authorised persons identified by their position;
 - (3) a retention policy and accountability, including the measures to be taken to ensure the security of the CVR recordings and CVR transcripts and their protection from misuse. The retention policy should specify the period of time after which CVR recordings and identified CVR transcripts are destroyed;

3 <http://www.bea.aero/en/bea/la-technique/guidance.on.detection.of.audio.anomalies.on.CVR.recordings.pdf>

- (4) a description of the uses made of the CVR recordings and of their transcripts;
 - (5) the participation of flight crew member representatives in the assessment of the CVR recordings or their transcripts;
 - (6) the conditions under which advisory briefing or remedial training should take place; this should always be carried out in a constructive and non-punitive manner; and
 - (7) the conditions under which actions other than advisory briefing or remedial training may be taken for reasons of gross negligence or significant continuing safety concern.
- (b) Each time a CVR recording file is read out under the conditions defined by CAT.GEN.MPA.195(f)(1):
- (1) parts of the CVR recording file that contain information with a privacy content should be deleted to the extent possible, and it should not be permitted that the detail of information with a privacy content is transcribed; and
 - (2) the operator should retain, and when requested, provide to the competent authority:
 - (i) information on the use made (or the intended use) of the CVR recording; and
 - (ii) evidence that the persons concerned consented to the use made (or the intended use) of the CVR recording file.
- (c) The safety manager or the person identified by the operator to fulfil this role should be responsible for the protection and use of the CVR recordings and of their transcripts, as well as the assessment of issues and their transmission to the manager(s) responsible for the process concerned.
- (d) In case a third party is involved in the use of CVR recordings, contractual agreements with this third party should, when applicable, cover the aspects enumerated in (a) and (b).

GM1 CAT.GEN.MPA.195(f)(1) Handling of flight recorder recordings: preservation, production, protection and use

USE OF CVR RECORDINGS FOR MAINTAINING OR IMPROVING SAFETY

- (a) The CVR is primarily a tool for the investigation of accidents and serious incidents by investigating authorities. Misuse of CVR recordings is a breach of the right to privacy and it works against an effective safety culture inside the operator.
- (b) It is noteworthy that the flight data recorder (FDR) may be used for a flight data monitoring (FDM) programme; however, in that case the principles of confidentiality and access restriction of the FDM programme apply to the FDR recordings. Because the CVR is recording the voices of the crew and verbal communications with a privacy content, the CVR recordings must be protected and handled with even more care than FDM data.
- (c) Therefore, the use of a CVR recording, when for purposes other than CVR serviceability or those laid down by Regulation (EU) No 996/2010, should be subject to the free prior consent of the persons concerned, and framed by a procedure that is endorsed by all parties and that protects the privacy of crew members and (if applicable) maintenance staff.

AMC1 CAT.GEN.MPA.195(f)(1a) Handling of flight recorder recordings: preservation, production, protection and use

CVR RECORDING INSPECTION FOR ENSURING SERVICEABILITY

- (a) When an inspection of the CVR recording is performed for ensuring audio quality and intelligibility of recorded communications:

- (1) the privacy of the CVR recording should be ensured (e.g. by locating the CVR replay equipment in a separated area and/or using headsets);
 - (2) access to the CVR replay equipment should be restricted to specifically authorised persons;
 - (3) provision should be made for the secure storage of the CVR recording medium, the CVR recording files and copies thereof;
 - (4) the CVR recording files and copies thereof should be destroyed not earlier than two months and not later than one year after completion of the CVR recording inspection, except that audio samples with no privacy content may be retained for enhancing the CVR recording inspection (e.g. for comparing audio quality);
 - (5) only the accountable manager of the operator, and when identified to comply with ORO.GEN.200, the safety manager should be entitled to request a copy of the CVR recording files.
- (b) The conditions enumerated in (a) should also be complied with if the inspection of the CVR recording is subcontracted to a third party. The contractual agreements with the third party should explicitly cover these aspects.

GM1 CAT.GEN.MPA.195(f)(2) Handling of flight recorder recordings: preservation, production, protection and use

USE OF FDR DATA FOR AN FDM PROGRAMME

The use of FDR data in the framework of an FDM programme may be acceptable if it fulfils the conditions set by sub-paragraph (f)(2) of CAT.GEN.MPA.195.

CAT.GEN.MPA.200 Transport of dangerous goods

- (a) Unless otherwise permitted by this Annex, the transport of dangerous goods by air shall be conducted in accordance with Annex 18 to the Chicago Convention as last amended and amplified by the 'Technical instructions for the safe transport of dangerous goods by air' (ICAO Doc 9284-AN/905), including its supplements and any other addenda or corrigenda.
- (b) Dangerous goods shall only be transported by an operator approved in accordance with Annex V (Part-SPA), Subpart G, except when:
 - (1) they are not subject to the technical instructions in accordance with Part 1 of those instructions; or
 - (2) they are carried by passengers or crew members, or are in baggage, in accordance with Part 8 of the technical instructions.
- (c) An operator shall establish procedures to ensure that all reasonable measures are taken to prevent dangerous goods from being carried on board inadvertently.
- (d) The operator shall provide personnel with the necessary information enabling them to carry out their responsibilities, as required by the technical instructions.
- (e) The operator shall, in accordance with the technical instructions, report without delay to the competent authority and the appropriate authority of the State of occurrence in the event of:
 - (1) any dangerous goods accidents or incidents;
 - (2) the discovery of undeclared or misdeclared dangerous goods in cargo or mail; or
 - (3) the finding of dangerous goods carried by passengers or crew members, or in their baggage, when not in accordance with Part 8 of the technical instructions.
- (f) The operator shall ensure that passengers are provided with information about dangerous goods in accordance with the technical instructions.
- (g) The operator shall ensure that notices giving information about the transport of dangerous goods are provided at acceptance points for cargo as required by the technical instructions.

AMC1 CAT.GEN.MPA.200(e) Transport of dangerous goods**DANGEROUS GOODS ACCIDENT AND INCIDENT REPORTING**

- (a) Any type of dangerous goods accident or incident, or the finding of undeclared or misdeclared dangerous goods should be reported, irrespective of whether the dangerous goods are contained in cargo, mail, passengers' baggage or crew baggage. For the purposes of the reporting of undeclared and misdeclared dangerous goods found in cargo, the Technical Instructions considers this to include items of operators' stores that are classified as dangerous goods.
- (b) The first report should be dispatched within 72 hours of the event. It may be sent by any means, including e-mail, telephone or fax. This report should include the details that are known at that time, under the headings identified in (c). If necessary, a subsequent report should be made as soon as possible giving all the details that were not known at the time the first report was sent. If a report has been made verbally, written confirmation should be sent as soon as possible.
- (c) The first and any subsequent report should be as precise as possible and should contain the following data, where relevant:
 - (1) date of the incident or accident or the finding of undeclared or misdeclared dangerous goods;

- (2) location, the flight number and flight date;
 - (3) description of the goods and the reference number of the air waybill, pouch, baggage tag, ticket, etc.;
 - (4) proper shipping name (including the technical name, if appropriate) and UN/ID number, when known;
 - (5) class or division and any subsidiary risk;
 - (6) type of packaging, and the packaging specification marking on it;
 - (7) quantity;
 - (8) name and address of the shipper, passenger, etc.;
 - (9) any other relevant details;
 - (10) suspected cause of the incident or accident;
 - (11) action taken;
 - (12) any other reporting action taken; and
 - (13) name, title, address and telephone number of the person making the report.
- (d) Copies of relevant documents and any photographs taken should be attached to the report.
- (e) A dangerous goods accident or incident may also constitute an aircraft accident, serious incident or incident. Reports should be made for both types of occurrences when the criteria for each are met.
- (f) The following dangerous goods reporting form should be used, but other forms, including electronic transfer of data, may be used provided that at least the minimum information of this AMC is supplied:

DANGEROUS GOODS OCCURRENCE REPORT**DGOR No:**

1. Operator:	2. Date of Occurrence:	3. Local time of occurrence:
4. Flight date:	5. Flight No:	
6. Departure aerodrome:	7. Destination aerodrome:	
8. Aircraft type:	9. Aircraft registration:	
10. Location of occurrence:	11. Origin of the goods:	
12. Description of the occurrence, including details of injury, damage, etc. (if necessary, continue on the reverse of this form):		

DANGEROUS GOODS OCCURRENCE REPORT**DGOR No:**

13. Proper shipping name (including the technical name):		14. UN/ID No (when known):	
15. Class/Division (when known):	16. Subsidiary risk(s):	17. Packing group:	18 Category (Class 7 only):
19. Type of packaging:	20. Packaging specification marking:	21. No of packages:	22. Quantity (or transport index, if applicable):
23. Reference No of Airway Bill:			
24. Reference No of courier pouch, baggage tag, or passenger ticket:			
25. Name and address of shipper, agent, passenger, etc.:			
26. Other relevant information (including suspected cause, any action taken):			
27. Name and title of person making report:		28. Telephone No:	
29. Company:		30. Reporters ref:	
31. Address:		32. Signature:	
		33. Date:	
Description of the occurrence (continuation)			

Notes for completion of the form:

1. A dangerous goods accident is as defined in Annex I. For this purpose, serious injury is as defined in Regulation (EU) No 996/2010⁴.
2. This form should also be used to report any occasion when undeclared or misdeclared dangerous goods are discovered in cargo, mail or unaccompanied baggage or when accompanied baggage contains dangerous goods which passengers or crew are not permitted to take on aircraft.
3. The initial report should be dispatched unless exceptional circumstances prevent this. This occurrence report form, duly completed, should be sent as soon as possible, even if all the information is not available.
4. Copies of all relevant documents and any photographs taken should be attached to this report.
5. Any further information, or any information not included in the initial report, should be sent as soon as possible to the authorities identified in CAT.GEN.MPA.200(e).
6. Providing it is safe to do so, all dangerous goods, packaging, documents, etc., relating to the occurrence should be retained until after the initial report has been sent to the authorities identified in CAT.GEN.MPA.200(e) and they have indicated whether or not these should continue to be retained.

GM1 CAT.GEN.MPA.200 Transport of dangerous goods

GENERAL

- (a) The requirement to transport dangerous goods by air in accordance with the Technical Instructions is irrespective of whether:
 - (1) the flight is wholly or partly within or wholly outside the territory of a State; or
 - (2) an approval to carry dangerous goods in accordance with Annex V (Part-SPA), Subpart G is held.
- (b) The Technical Instructions provide that in certain circumstances dangerous goods, which are normally forbidden on an aircraft, may be carried. These circumstances include cases of extreme urgency or when other forms of transport are inappropriate or when full compliance with the prescribed requirements is contrary to the public interest. In these circumstances, all the States concerned may grant exemptions from the provisions of the Technical Instructions provided that an overall level of safety which is at least equivalent to that provided by the Technical Instructions is achieved. Although exemptions are most likely to be granted for the carriage of dangerous goods that are not permitted in normal circumstances, they may also be granted in other circumstances, such as when the packaging to be used is not provided for by the appropriate packing method or the quantity in the packaging is greater than that permitted. The Technical Instructions also make provision for some dangerous goods to be carried when an approval has been granted only by the State of origin and the State of the operator.
- (c) When an exemption is required, the States concerned are those of origin, transit, overflight and destination of the consignment and that of the operator. For the State of overflight, if none of the criteria for granting an exemption are relevant, an exemption may be granted based solely on whether it is believed that an equivalent level of safety in air transport has been achieved.

⁴ Regulation (EU) No 996/2010 of the European Parliament and of the Council of 20 October 2010 on the investigation and prevention of accidents and incidents in civil aviation and repealing Directive 94/56/EC (OJ L 295, 12.11.2010, p. 35).

- (d) The Technical Instructions provide that exemptions and approvals are granted by the ‘appropriate national authority’, which is intended to be the authority responsible for the particular aspect against which the exemption or approval is being sought. The Instructions do not specify who should seek exemptions and, depending on the legislation of the particular State, this may mean the operator, the shipper or an agent. If an exemption or approval has been granted to other than the operator, the operator should ensure a copy has been obtained before the relevant flight. The operator should ensure all relevant conditions on an exemption or approval are met.
- (e) The exemption or approval referred to in (b) to (d) is in addition to the approval required by Annex V (Part SPA), Subpart G.

CAT.GEN.MPA.205 Aircraft tracking system — Aeroplanes

- (a) By 16 December 2018 at the latest, the operator shall establish and maintain, as part of the system for exercising operational control over the flights, an aircraft tracking system, which includes the flights eligible to (b) when performed with the following aeroplanes:
- (1) aeroplanes with an MCTOM of more than 27 000 kg, with an MOPSC of more than 19, and first issued with an individual CofA before 16 December 2018, which are equipped with a capability to provide a position additional to the secondary surveillance radar transponder;
 - (2) all aeroplanes with an MCTOM of more than 27 000 kg, with an MOPSC of more than 19, and first issued with an individual CofA on or after 16 December 2018; and
 - (3) all aeroplanes with an MCTOM of more than 45 500 kg and first issued with an individual CofA on or after 16 December 2018.
- (b) Flights shall be tracked by the operator from take-off to landing, except when the planned route and the planned diversion routes are fully included in airspace blocks where:
- (1) ATS surveillance service is normally provided which is supported by ATC surveillance systems locating the aircraft at time intervals with adequate duration; and
 - (2) the operator has provided to competent air navigation service providers necessary contact information.

CAT.GEN.MPA.210 Location of an aircraft in distress — Aeroplanes

The following aeroplanes shall be equipped with robust and automatic means to accurately determine, following an accident where the aeroplane is severely damaged, the location of the point of end of flight:

- (1) all aeroplanes with an MCTOM of more than 27 000 kg, with an MOPSC of more than 19 and first issued with an individual CofA on or after 1 January 2021; and
- (2) all aeroplanes with an MCTOM of more than 45 500 kg and first issued with an individual CofA on or after 1 January 2021.

SECTION 2
Non motor-powered aircraft

CAT.GEN.NMPA.100 Responsibilities of the commander

- (a) The commander shall:
- (1) be responsible for the safety of all crew members and passengers on board, as soon as the commander arrives on board of the aircraft, until the commander leaves the aircraft at the end of the flight;
 - (2) be responsible for the operation and safety of the aircraft:
 - (i) for balloons, from the moment the inflating of the envelope is started until the envelope is deflated, unless the commander has delegated the responsibility to another qualified person during the filling phase until the commander arrives as specified in the operations manual (OM);
 - (ii) for sailplanes, from the moment the launch procedure is started until the sailplane comes to a rest at the end of the flight;
 - (3) have authority to give all commands and take any appropriate actions for the purpose of securing the safety of the aircraft and of persons and/or property carried therein in accordance with 7.c of Annex IV to Regulation (EC) No 216/2008;
 - (4) have authority not to embark and to disembark any person that may represent a potential hazard to the safety of the aircraft or its occupants;
 - (5) not allow a person to be carried in the aircraft who appears to be under the influence of alcohol or drugs to the extent that the safety of the aircraft or its occupants is likely to be endangered;
 - (6) ensure that all passengers have received a safety briefing;
 - (7) ensure that all operational procedures and checklists are complied with in accordance with the operations manual;
 - (8) ensure that the pre-flight inspection has been carried out in accordance with the requirements of Annex I (Part-M) to Regulation (EC) No 2042/2003;
 - (9) be satisfied that relevant emergency equipment remains easily accessible for immediate use;
 - (10) comply with the relevant requirements of the operator's occurrence reporting schemes;
 - (11) comply with all flight and duty time limitations (FTL) and rest requirements applicable to his/her activities;
 - (12) when undertaking duties for more than one operator:
 - (i) maintain his/her individual records regarding flight and duty times and rest periods as referred to in applicable FTL requirements; and
 - (ii) provide each operator with the data needed to schedule activities in accordance with the applicable FTL requirements.
- (b) The commander shall not perform duties on an aircraft:

- (1) when under the influence of psychoactive substances or alcohol or when unfit due to injury, fatigue, medication, sickness or other similar causes;
 - (2) until a reasonable time period has elapsed after deep water diving or following blood donation;
 - (3) if applicable medical requirements are not fulfilled;
 - (4) if he/she is in any doubt of being able to accomplish his/her assigned duties; or
 - (5) if he/she knows or suspects that he/she is suffering from fatigue as referred to in 7.f of Annex IV to Regulation (EC) No 216/2008 or feels otherwise unfit, to the extent that the flight may be endangered.
- (c) The commander shall, in an emergency situation that requires immediate decision and action, take any action the commander considers necessary under the circumstances in accordance with 7.d of Annex IV to Regulation (EC) No 216/2008. In such cases he/she may deviate from rules, operational procedures and methods in the interest of safety.
- (d) The commander of a balloon shall:
- (1) be responsible for the pre-flight briefing of those persons assisting in the inflation and deflation of the envelope;
 - (2) ensure that no person is smoking on board or within the direct vicinity of the balloon; and
 - (3) ensure that persons assisting in the inflation and deflation of the envelope wear appropriate protective clothing.

AMC1 CAT.GEN.NMPA.100(b)(1) Responsibilities of the commander**ALCOHOL CONSUMPTION**

The operator should issue instructions concerning the consumption of alcohol by commanders. The instructions should not be less restrictive than the following:

- (a) no alcohol should be consumed less than 8 hours prior to the specified reporting time for a flight duty period or the commencement of standby;
- (b) the blood alcohol level should not exceed the lower of the national requirements or 0.2 per thousand at the start of a flight duty period; and
- (c) no alcohol should be consumed during the flight duty period or whilst on standby.

GM1 CAT.GEN.NMPA.100(b)(2) Responsibilities of the commander**ELAPSED TIME BEFORE RETURNING TO FLYING DUTY**

24 hours is a suitable minimum length of time to allow after normal blood donation or normal recreational (sport) diving before returning to flying duties. This should be considered by operators when determining a reasonable time period for the guidance of crew members.

PART-MED

Information on the effects of medication, drugs, other treatments and alcohol can be found in Annex IV (Part-MED) to Commission Regulation (EU) No 1178/2011⁵.

GM1 CAT.GEN.NMPA.100(d)(3) Responsibilities of the commander**PROTECTIVE CLOTHING — BALLOON OPERATIONS**

Protective clothing includes:

- (a) long sleeves and trousers preferably made out of natural fibres;
- (b) stout footwear; and
- (c) gloves.

⁵ Commission Regulation (EU) No 1178/2011 of 3 November 2011 laying down technical requirements and administrative procedures related to civil aviation aircrew pursuant to Regulation (EC) No 216/2008 of the European Parliament and of the Council (OJ L 311, 25.11.2011, p. 1).

CAT.GEN.NMPA.105 Additional balloon crew member

- (a) When a balloon carries more than 19 passengers, at least one additional crew member appropriately experienced and trained shall be present on board to assist passengers in the event of an emergency.
- (b) The additional crew member shall not perform duties on a balloon:
 - (1) when under the influence of psychoactive substances or alcohol;
 - (2) when unfit due to injury, fatigue, medication, sickness or other similar causes; or
 - (3) until a reasonable time period has elapsed after deep water diving or following blood donation.

AMC1 CAT.GEN.NMPA.105(a) Additional balloon crew member

INSTRUCTIONS FOR THE ADDITIONAL CREW MEMBER

The additional crew member should have taken part in:

- (a) the following practical training inflations with subsequent flights, as applicable:
 - (1) three on any balloon;
 - (2) two on balloons with baskets of a capacity of at least seven passengers; and
 - (3) one on a balloon with a basket of a capacity of more than 19 passengers;
- (b) at least two landings under (a) with a ground speed of at least 5 kt; and
- (c) training in first-aid and in the use of the fire extinguisher at intervals of maximum 24 months.

AMC1 CAT.GEN.NMPA.105(b)(1) Additional balloon crew member

ALCOHOL CONSUMPTION

The operator should issue instructions concerning the consumption of alcohol by crew members. The instructions should not be less restrictive than the following:

- (a) no alcohol should be consumed less than 8 hours prior to the specified reporting time for a flight duty period or the commencement of standby;
- (b) the blood alcohol level should not exceed the lower of the national requirements or 0.2 per thousand at the start of a flight duty period;
- (c) no alcohol should be consumed during the flight duty period or whilst on standby.

GM1 CAT.GEN.NMPA.105(b)(2) Additional balloon crew member

ELAPSED TIME BEFORE RETURNING TO FLYING DUTY

24 hours is a suitable minimum length of time to allow after normal blood donation or normal recreational (sport) diving before returning to flying duties. This should be considered by operators when determining a reasonable time period for the guidance of crew members.

PART-MED

Information on the effects of medication, drugs, other treatments and alcohol can be found in Annex IV (Part-MED) to Commission Regulation (EU) No 1178/2011.

CAT.GEN.NMPA.110 Authority of the commander

The operator shall take all reasonable measures to ensure that all persons carried in the aircraft obey all lawful commands given by the commander for the purpose of securing the safety of the aircraft and of persons or property carried therein.

CAT.GEN.NMPA.115 Common language

The operator shall ensure that all crew members can communicate with each other in a common language.

CAT.GEN.NMPA.120 Portable electronic devices

The operator shall not permit any person to use a portable electronic device (PED) on board an aircraft that could adversely affect the performance of the aircraft's systems and equipment and shall take all reasonable measures to prevent such use.

GM1 CAT.GEN.NMPA.120 Portable electronic devices**GENERAL**

- (a) A portable electronic device (PED) is any kind of electronic device not being part of the certified aircraft configuration, but brought on-board the aircraft either by crew members or passengers, or being inside the personal luggage or cargo.
- (b) The associated risk relates to interference of the PED with electronic operated aircraft systems, mainly instruments or communication equipment. The interference can result in malfunctioning or misleading information of on-board systems and communication disturbance which may subsequently increase flight crew workload.
- (c) Interference may be caused by transmitters being part of the PED functionality or by unintentional transmissions of the PED. Due to the short distance and the lack of shielding from a metal aircraft structure, the risk of interference is to be considered higher in small aircraft compared to aircraft made of big metal structures. It has been found that compliance to the electromagnetic compatibility (EMC) Directive 2004/108/EC⁶ and related European standards as indicated by the CE marking is not sufficient to exclude the existence of interference. A well-known interference is the demodulation of the transmitted signal from GSM mobile phones leading to audio disturbances in other systems. Similar to this case, interferences can hardly be predicted during the PED design and protecting aircraft electronic against all kind of potential interferences is similar impossible. Therefore, not operating PEDs on-board aircraft is the safe option, especially as effects may not be identified immediately but under the most inconvenient circumstances.
- (d) Guidance to follow in case of fire caused by PEDs is provided by the International Civil Aviation Organisation, 'Emergency response guidance for aircraft incidents involving dangerous goods', ICAO Doc 9481-AN/928.

⁶ Directive 2004/108/EC of the European Parliament and of the Council of 15 December 2004 on the approximation of the laws of the Member States relating to electromagnetic compatibility (OJ L 390, 31.12.2004, p. 24).

CAT.GEN.NMPA.125 Information on emergency and survival equipment carried

The operator shall at all times have available for immediate communication to rescue coordination centres (RCCs) lists containing information on the emergency and survival equipment carried on board any of their aircraft.

AMC1 CAT.GEN.NMPA.125 Information on emergency and survival equipment carried

ITEMS FOR COMMUNICATION TO THE RESCUE COORDINATION CENTRE

The information, compiled in a list, should include, as applicable:

- (a) the number, colour and type of life-rafts and pyrotechnics;
- (b) details of emergency medical supplies and water supplies; and
- (c) the type and frequencies of the emergency portable radio equipment.

CAT.GEN.NMPA.130 Alcohol and drugs

The operator shall take all reasonable measures to ensure that no person enters or is in an aircraft when under the influence of alcohol or drugs to the extent that the safety of the aircraft or its occupants is likely to be endangered.

CAT.GEN.NMPA.135 Endangering safety

The operator shall take all reasonable measures to ensure that no person recklessly or negligently acts or omits to act so as to:

- (a) endanger an aircraft or person therein or on the ground; or
- (b) cause or permit an aircraft to endanger any person or property.

CAT.GEN.NMPA.140 Documents, manuals and information to be carried

- (a) The following documents, manuals and information shall be carried on each flight, as originals or copies unless otherwise specified:
 - (1) the aircraft flight manual (AFM), or equivalent document(s);
 - (2) the original certificate of registration;
 - (3) the original certificate of airworthiness (CofA);
 - (4) the noise certificate, if applicable;
 - (5) a copy of the air operator certificate (AOC);
 - (6) the operations specifications relevant to the aircraft type, issued with the AOC, if applicable;
 - (7) the aircraft radio licence, if applicable;
 - (8) the third party liability insurance certificate(s);
 - (9) the journey log, or equivalent, for the aircraft;
 - (10) the aircraft technical log, in accordance with Annex I (Part-M) to Regulation (EC) No 2042/2003, if applicable;
 - (11) the MEL or CDL, if applicable;
 - (12) details of the filed air traffic service (ATS) flight plan, if applicable;
 - (13) current and suitable aeronautical charts for the route of the proposed flight and all routes along which it is reasonable to expect that the flight may be diverted;
 - (14) procedures and visual signals information for use by intercepting and intercepted aircraft;
 - (15) information concerning search and rescue services for the area of the intended flight;
 - (16) appropriate notices to airmen (NOTAMs) and aeronautical information service (AIS) briefing documentation;
 - (17) appropriate meteorological information;
 - (18) passenger manifests, if applicable;
 - (19) for sailplanes, mass and balance documentation and for balloons, mass documentation;
 - (20) the operational flight plan, if applicable; and

- (21) any other documentation that may be pertinent to the flight or is required by the States concerned with the flight.
- (b) Notwithstanding (a), the documents, manuals and information specified there may be carried in the retrieve vehicle or retained at the aerodrome or operating site on flights intending to:
- (1) take off and land at the same aerodrome or operating site; or
 - (2) remain within a local area specified in the operations manual.

GM1 CAT.GEN.NMPA.140 Documents, manuals and information to be carried

GENERAL

The documents, manuals and information may be available in a form other than on printed paper. Accessibility, usability and reliability should be assured.

GM1 CAT.GEN.NMPA.140(a)(1) Documents, manuals and information to be carried

AIRCRAFT FLIGHT MANUAL OR EQUIVALENT DOCUMENT(S)

At least the operating limitations, normal and emergency procedures should be available to the commander during operation by providing the relevant data of the AFM or by other means (e.g. placards, quick reference cards) that effectively accomplish the purpose.

GM1 CAT.GEN.NMPA.140(a)(5)(6) Documents, manuals and information to be carried

CERTIFIED TRUE COPIES

- (a) Certified true copies may be provided:
- (1) directly by the competent authority; or
 - (2) by persons holding privileges for certification of official documents in accordance with applicable Member State's legislation, e.g. public notaries, authorised officials in public services.
- (b) Translations of the AOC including operations specifications do not need to be certified.

GM1 CAT.GEN.NMPA.140(a)(9) Documents, manuals and information to be carried

JOURNEY LOG OR EQUIVALENT

'Journey log or equivalent' means that the required information may be recorded in documentation other than a log book, such as the operational flight plan or the aircraft technical log.

AMC1 CAT.GEN.NMPA.140(a)(13) Documents, manuals and information to be carried

CURRENT AND SUITABLE AERONAUTICAL CHARTS

- (a) The aeronautical charts carried should contain data appropriate to the applicable air traffic regulations, rules of the air, flight altitudes, area/route and nature of the operation. Due consideration should be given to carriage of textual and graphic representations of:
- (1) aeronautical data including, as appropriate for the nature of the operation:
 - (i) airspace structure;

- (ii) significant points, navigation aids (nav aids) and air traffic services (ATS) routes;
 - (iii) navigation and communication frequencies;
 - (iv) prohibited, restricted and danger areas; and
 - (v) sites of other relevant activities that may hazard the flight;
- and
- (2) topographical data, including terrain and obstacle data.
- (b) A combination of different charts and textual data may be used to provide adequate and current data.
 - (c) The aeronautical data should be appropriate for the current aeronautical information regulation and control (AIRAC) cycle.
 - (d) The topographical data should be reasonably recent, having regard to the nature of the planned operation.

AMC1 CAT.GEN.NMPA.140(a)(14) Documents, manuals and information to be carried

PROCEDURES AND VISUAL SIGNALS FOR USE BY INTERCEPTING AND INTERCEPTED AIRCRAFT

The procedures and the visual signals information for use by intercepting and intercepted aircraft should reflect those contained in International Civil Aviation Organization (ICAO) Annex 2. This may be part of the operations manual.

GM1 CAT.GEN.NMPA.140(a)(15) Documents, manuals and information to be carried

SEARCH AND RESCUE INFORMATION

This information is usually found in the State's aeronautical information publication.

GM1 CAT.GEN.NMPA.140(a)(21) Documents, manuals and information to be carried

DOCUMENTS THAT MAY BE PERTINENT TO THE FLIGHT

Any other documents that may be pertinent to the flight or required by the States concerned with the flight may include, for example, forms to comply with reporting requirements.

STATES CONCERNED WITH THE FLIGHT

The States concerned are those of origin, transit, overflight and destination of the flight.

CAT.GEN.NMPA.145 Provision of documentation and records

The commander shall, within a reasonable time of being requested to do so by a person authorised by an authority, provide to that person the documentation required to be carried on board.

CAT.GEN.NMPA.150 Transport of dangerous goods

- (a) The transport of dangerous goods shall not be permitted, except when:
- (1) they are not subject to the Technical Instructions for the Safe Transport of Dangerous Goods by Air (ICAO Doc 9284-AN/905) in accordance with Part 1 of those Instructions; or
 - (2) they are carried by passengers or crew members, or are in baggage, in accordance with Part 8 of the Technical Instructions.
- (b) The operator shall establish procedures to ensure that all reasonable measures are taken to prevent dangerous goods from being carried on board inadvertently.
- (c) The operator shall provide personnel with the necessary information enabling them to carry out their responsibilities.

GM1 CAT.GEN.NMPA.150(a)(1) Transport of dangerous goods

EXCEPTIONS, APPROVALS, EXEMPTIONS

- (a) The Technical Instructions (T.I.) provide for exceptions to the provisions for the transport of dangerous goods for those goods that are required on board in accordance with airworthiness rules and/or are used for operational purposes, e.g. portable electronic devices.
- (b) Furthermore, the T.I. allow to deviate from provisions on how to transport dangerous goods through approvals. However, such approvals are likely to be used only for operators holding a specific approval to dangerous goods as in Annex V (Part-SPA), Subpart G. Approvals under Part 1 of the T.I. may, therefore, not be relevant for commercial air transport (CAT) operations with sailplanes and balloons.
- (c) The T.I. also provide for exemptions. An exemption would allow the transport of dangerous goods which would normally be forbidden. Exemptions may be granted by the State of the operator, the States of origin, transit, overflight and destination. Exemptions, as stated in the T.I., can be granted under the following conditions:
- (1) the overall level of safety is at least equivalent to the level of safety provided for in the T.I.; and
 - (2) at least one of the following three criteria is fulfilled:
 - (i) in cases of extreme urgency; or
 - (ii) when other forms of transport are inappropriate; or
 - (iii) when full compliance with the T.I. is contrary to the public interest.

GM1 CAT.GEN.NMPA.150(a)(2) Transport of dangerous goods

DANGEROUS GOODS CARRIED UNDER THE PROVISIONS OF PART 8 OF THE T.I.

Passengers and crew may carry certain dangerous goods under the provisions of Part 8 of the T.I. either in their baggage or on the person. The T.I. specify for which goods an approval from the operator or a

notification to the commander is compulsory. The T.I., furthermore, specify restrictions to the carriage of some of these goods.

GM1 CAT.GEN.NMPA.150(b)(c) Transport of dangerous goods

PROCEDURES AND INFORMATION TO PERSONNEL AND PASSENGERS

- (a) Personnel should be trained to get familiarised with the items that are allowed or forbidden on board to an extent that they can inform the passengers accordingly. An updated list of permitted items under Part 8 of the T. I. should be available to the personnel. This can be a poster, a leaflet or anything that can be easily understood and shown to the passengers when needed. This list should also specify the items that are forbidden under all circumstances as established in Part 8 of the T.I.
- (b) Information should be given to the passengers as regards goods that are forbidden to take on board before the flight takes place. This can be done in the website where the ticket is bought or in a summary written on the physical ticket that is given to the passenger. In case this is not possible, the crew can provide this information in a briefing before the flight.
- (c) An operator should provide information in the operations manual to enable the commander and other personnel to carry out their responsibilities and identify which dangerous goods can be allowed on board.
- (d) Procedures should also be established and described in the operations manual to respond to accidents or incidents involving dangerous goods. The relevant personnel should be familiar with them.

SUBPART B: OPERATING PROCEDURES

SECTION 1 *Motor-powered aircraft*

CAT.OP.MPA.100 Use of air traffic services

- (a) The operator shall ensure that:
- (1) air traffic services (ATS) appropriate to the airspace and the applicable rules of the air are used for all flights whenever available;
 - (2) in-flight operational instructions involving a change to the ATS flight plan, when practicable, are coordinated with the appropriate ATS unit before transmission to an aircraft.
- (b) Notwithstanding (a), the use of ATS is not required unless mandated by air space requirements for:
- (1) operations under VFR by day of other-than complex motor-powered aeroplanes;
 - (2) helicopters with an MCTOM of 3 175 kg or less operated by day and over routes navigated by reference to visual landmarks; or
 - (3) local helicopter operations,
provided that search and rescue service arrangements can be maintained.

GM1 CAT.OP.MPA.100(a)(2) Use of air traffic services

IN-FLIGHT OPERATIONAL INSTRUCTIONS

When coordination with an appropriate air traffic service (ATS) unit has not been possible, in-flight operational instructions do not relieve a commander of the responsibility for obtaining an appropriate clearance from an ATS unit, if applicable, before making a change in flight plan.

CAT.OP.MPA.105 Use of aerodromes and operating sites

- (a) The operator shall only use aerodromes and operating sites that are adequate for the type(s) of aircraft and operation(s) concerned.
- (b) The use of operating sites shall only apply to:
 - (1) other-than complex motor-powered aeroplanes; and
 - (2) helicopters.

AMC1 CAT.OP.MPA.105 Use of aerodromes and operating sites

DEFINING OPERATING SITES — HELICOPTERS

When defining operating sites (including infrequent or temporary sites) for the type(s) of helicopter(s) and operation(s) concerned, the operator should take account of the following:

- (a) An adequate site is a site that the operator considers to be satisfactory, taking account of the applicable performance requirements and site characteristics (guidance on standards and criteria are contained in ICAO Annex 14 Volume 2 and in the ICAO *Heliport Manual* (Doc 9261-AN/903)).
- (b) The operator should have in place a procedure for the survey of sites by a competent person. Such a procedure should take account of possible changes to the site characteristics which may have taken place since last surveyed.
- (c) Sites that are pre-surveyed should be specifically specified in the operations manual. The operations manual should contain diagrams or/and ground and aerial photographs, and depiction (pictorial) and description of:
 - (1) the overall dimensions of the site;
 - (2) location and height of relevant obstacles to approach and take-off profiles, and in the manoeuvring area;
 - (3) approach and take-off flight paths;
 - (4) surface condition (blowing dust/snow/sand);
 - (5) helicopter types authorised with reference to performance requirements;
 - (6) provision of control of third parties on the ground (if applicable);
 - (7) procedure for activating site with land owner or controlling authority;
 - (8) other useful information, for example, appropriate ATS agency and frequency; and
 - (9) lighting (if applicable).
- (d) For sites that are not pre-surveyed, the operator should have in place a procedure that enables the pilot to make, from the air, a judgment on the suitability of a site. (c)(1) to (c)(6) should be considered.
- (e) Operations to non-pre-surveyed sites by night (except in accordance with SPA.HEMS.125 (b)(4)) should not be permitted.

AMC2 CAT.OP.MPA.105 Use of aerodromes and operating sites**HELIDECK**

- (a) The content of Part C of the operations manual relating to the specific usage of helidecks should contain both the listing of helideck limitations in a helideck limitations list (HLL) and a pictorial representation (template) of each helideck showing all necessary information of a permanent nature. The HLL should show, and be amended as necessary to indicate, the most recent status of each helideck concerning non-compliance with ICAO Annex 14 Volume 2, limitations, warnings, cautions or other comments of operational importance. An example of a typical template is shown in Figure 1 below.
- (b) In order to ensure that the safety of flights is not compromised, the operator should obtain relevant information and details for compilation of the HLL, and the pictorial representation, from the owner/operator of the helideck.
- (c) When listing helidecks, if more than one name of the helideck exists, the most common name should be used and other names should also be included. After renaming a helideck, the old name should be included in the HLL for the ensuing 6 months.
- (d) All helideck limitations should be included in the HLL. Helidecks without limitations should also be listed. With complex installations and combinations of installations (e.g. co-locations), a separate listing in the HLL, accompanied by diagrams where necessary, may be required.
- (e) Each helideck should be assessed based on limitations, warnings, cautions or comments to determine its acceptability with respect to the following that, as a minimum, should cover the factors listed below:
- (1) The physical characteristics of the helideck.
 - (2) The preservation of obstacle-protected surfaces is the most basic safeguard for all flights.
These surfaces are:
 - (i) the minimum 210° obstacle-free surface (OFS);
 - (ii) the 150° limited obstacle surface (LOS); and
 - (iii) the minimum 180° falling '5:1'-gradient with respect to significant obstacles. If this is infringed or if an adjacent installation or vessel infringes the obstacle clearance surfaces or criteria related to a helideck, an assessment should be made to determine any possible negative effect that may lead to operating restrictions.
 - (3) Marking and lighting:
 - (i) adequate perimeter lighting;
 - (ii) adequate floodlighting;
 - (iii) status lights (for night and day operations e.g. signalling lamp);
 - (iv) dominant obstacle paint schemes and lighting;
 - (v) helideck markings; and
 - (vi) general installation lighting levels. Any limitations in this respect should be annotated 'daylight only operations' on the HLL.
 - (4) Deck surface:
 - (i) surface friction;
 - (ii) helideck net;

This AMC is applicable until 01/07/2018, then it will be deleted.

- (iii) drainage system;
 - (iv) deck edge netting;
 - (v) tie down system; and
 - (vi) cleaning of all contaminants.
 - (5) Environment:
 - (i) foreign object damage;
 - (ii) physical turbulence generators;
 - (iii) bird control;
 - (iv) air quality degradation due to exhaust emissions, hot gas vents or cold gas vents; and
 - (v) adjacent helideck may need to be included in air quality assessment.
 - (6) Rescue and fire fighting:
 - (i) primary and complementary media types, quantities, capacity and systems personal protective equipment and clothing, breathing apparatus; and
 - (ii) crash box.
 - (7) Communications & navigation:
 - (i) aeronautical radio(s);
 - (ii) radio/telephone (R/T) call sign to match helideck name and side identification which should be simple and unique;
 - (iii) Non-directional beacon (NDB) or equivalent (as appropriate);
 - (iv) radio log; and
 - (v) light signal (e.g. signalling lamp).
 - (8) Fuelling facilities: in accordance with the relevant national guidance and regulations.
 - (9) Additional operational and handling equipment:
 - (i) windsock;
 - (ii) wind recording;
 - (iii) deck motion recording and reporting where applicable;
 - (iv) passenger briefing system;
 - (v) chocks;
 - (vi) tie downs; and
 - (vii) weighing scales.
 - (10) Personnel: trained helideck staff (e.g. helicopter landing officer/helicopter deck assistant and fire fighters, etc.).
 - (11) Other: as appropriate.
- (f) For helidecks about which there is incomplete information, 'limited' usage based on the information available may be specified by the operator prior to the first helicopter visit. During subsequent operations and before any limit on usage is lifted, information should be gathered and the following should apply:

- (1) Pictorial (static) representation:
- (i) template (see figure 1) blanks should be available, to be filled out during flight preparation on the basis of the information given by the helideck owner/operator and flight crew observations;
 - (ii) where possible, suitably annotated photographs may be used until the HLL and template have been completed;
 - (iii) until the HLL and template have been completed, operational restrictions (e.g. performance, routing, etc.) may be applied;
 - (iv) any previous inspection reports should be obtained by the operator; and
 - (v) an inspection of the helideck should be carried out to verify the content of the completed HLL and template, following which the helideck may be considered as fully adequate for operations.
- (2) With reference to the above, the HLL should contain at least the following:
- (i) HLL revision date and number;
 - (ii) generic list of helideck motion limitations;
 - (iii) name of helideck;
 - (iv) 'D' value; and
 - (v) limitations, warnings, cautions and comments.
- (3) The template should contain at least the following (see example below):
- (i) installation/vessel name;
 - (ii) R/T call sign;
 - (iii) helideck identification marking;
 - (iv) side panel identification marking;
 - (v) helideck elevation;
 - (vi) maximum installation/vessel height;
 - (vii) 'D' value;
 - (viii) type of installation/vessel:
 - fixed manned
 - fixed unmanned
 - ship type (e.g. diving support vessel)
 - semi-submersible
 - jack-up
 - (ix) name of owner/operator;
 - (x) geographical position;
 - (xi) communication and navigation (Com/Nav) frequencies and ident;
 - (xii) general drawing preferably looking into the helideck with annotations showing location of derrick, masts, cranes, flare stack, turbine and gas exhausts, side identification panels, windsock, etc.;

- (xiii) plan view drawing, chart orientation from the general drawing, to show the above. The plan view will also show the 210° orientation in degrees true;
- (xiv) type of fuelling:
 - pressure and gravity
 - pressure only
 - gravity only
 - none
- (xv) type and nature of fire fighting equipment;
- (xvi) availability of ground power unit (GPU);
- (xvii) deck heading;
- (xviii) maximum allowable mass;
- (xix) status light (Yes/No); and
- (xx) revision date of publication.

Figure 1
Helideck template

Installation/vessel name		R/T callsign: ...	Helideck identification: ...
Helideck elevation: 200 ft		Maximum height: 350 ft	Side identification: ...
Type of installation: ... ¹		D value: 22 m	
Position: ² N ...		Operator ³	
		ATIS: VHF 123.45	
COM	LOG: VHF 123.45	NAV	NBD: 123 (ident)
	Traffic: VHF 123.45		DME: 123
	Deck: VHF 123.45		VOR/DME: 123
			VOR: 123

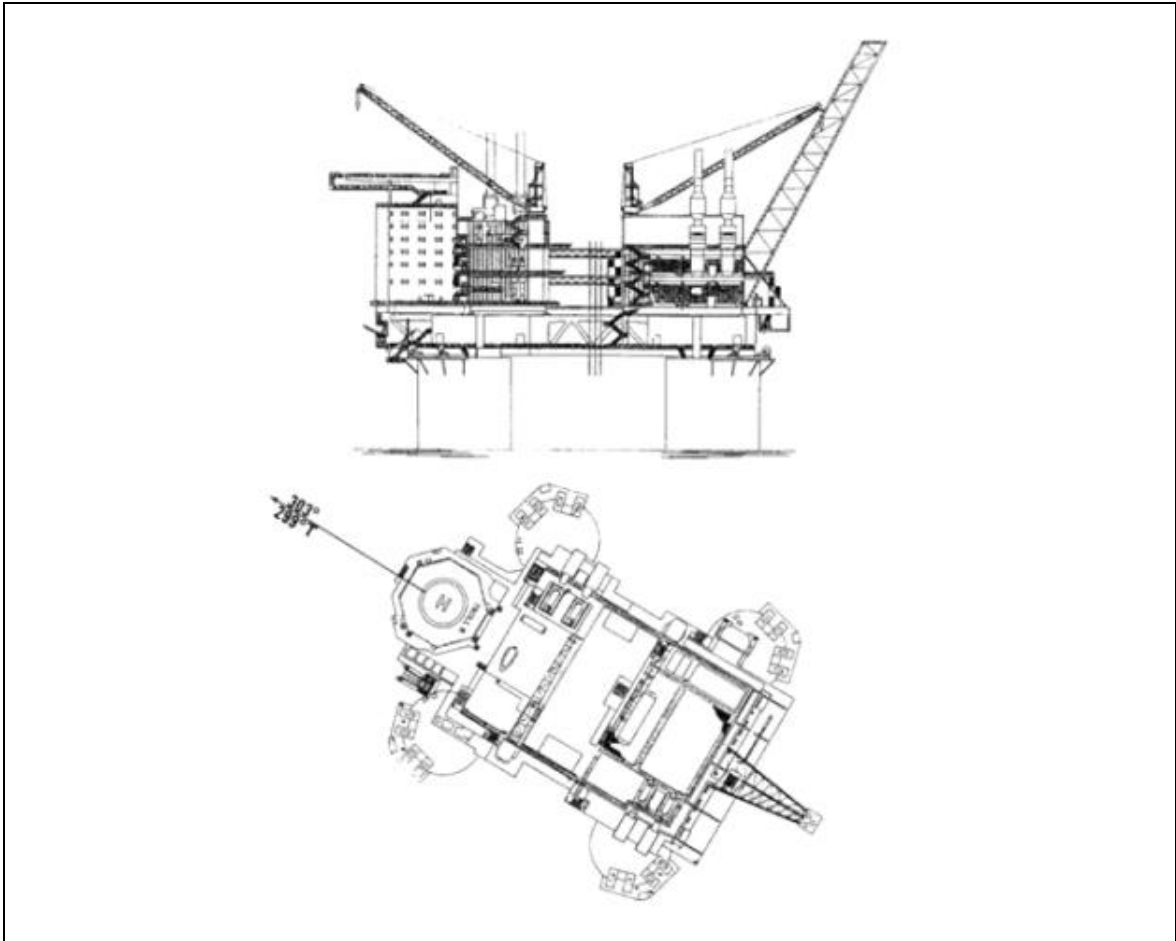

Fuelling: ... 4	GPU: ... 5	Deck heading: ...
MTOM: ... T	Status light: ... 6	Fire fighting equipment: ... 7
		Revision date: ...

- 1 Fixed manned, fixed unmanned; ship type (e.g. diving support vessel); semi-submersible; jack-up.
- 2 WGS84 grid.
- 3 NAM, AMOCO, etc.
- 4 Pressure/gravity; pressure; gravity; no.
- 5 Yes; no; 28V DC.
- 6 Yes; no.
- 7 Type (e.g. aqueous film forming foams (AFFF)) and nature (e.g. deck integrated fire fighting system (DIFFS)).

CAT.OP.MPA.106 Use of isolated aerodromes — aeroplanes

- (a) Using an isolated aerodrome as destination aerodrome with aeroplanes requires the prior approval by the competent authority.
- (b) An isolated aerodrome is one for which the alternate and final fuel reserve required to the nearest adequate destination alternate aerodrome is more than:
 - (1) for aeroplanes with reciprocating engines, fuel to fly for 45 minutes plus 15 % of the flying time planned to be spent at cruising level or two hours, whichever is less; or
 - (2) for aeroplanes with turbine engines, fuel to fly for two hours at normal cruise consumption above the destination aerodrome, including final reserve fuel.

CAT.OP.MPA.107 Adequate aerodrome

The operator shall consider an aerodrome as adequate if, at the expected time of use, the aerodrome is available and equipped with necessary ancillary services such as air traffic services (ATS), sufficient lighting, communications, weather reporting, navigation aids and emergency services.

CAT.OP.MPA.110 Aerodrome operating minima

- (a) The operator shall establish aerodrome operating minima for each departure, destination or alternate aerodrome planned to be used. These minima shall not be lower than those established for such aerodromes by the State in which the aerodrome is located, except when specifically approved by that State. Any increment specified by the competent authority shall be added to the minima.
- (b) The use of a head-up display (HUD), head-up guidance landing system (HUDLS) or enhanced vision system (EVS) may allow operations with lower visibilities than the established aerodrome operating minima if approved in accordance with SPA.LVO.
- (c) When establishing aerodrome operating minima, the operator shall take the following into account:
 - (1) the type, performance and handling characteristics of the aircraft;
 - (2) the composition, competence and experience of the flight crew;
 - (3) the dimensions and characteristics of the runways/final approach and take-off areas (FATOs) that may be selected for use;
 - (4) the adequacy and performance of the available visual and non-visual ground aids;
 - (5) the equipment available on the aircraft for the purpose of navigation and/or control of the flight path during the take-off, the approach, the flare, the landing, rollout and the missed approach;
 - (6) for the determination of obstacle clearance, the obstacles in the approach, missed approach and the climb-out areas necessary for the execution of contingency procedures;
 - (7) the obstacle clearance altitude/height for the instrument approach procedures;
 - (8) the means to determine and report meteorological conditions; and
 - (9) the flight technique to be used during the final approach.
- (d) The operator shall specify the method of determining aerodrome operating minima in the operations manual.

- (e) The minima for a specific approach and landing procedure shall only be used if all the following conditions are met:
- (1) the ground equipment shown on the chart required for the intended procedure is operative;
 - (2) the aircraft systems required for the type of approach are operative;
 - (3) the required aircraft performance criteria are met; and
 - (4) the crew is appropriately qualified.

AMC1 CAT.OP.MPA.110 Aerodrome operating minima

TAKE-OFF OPERATIONS — AEROPLANES

(a) General

- (1) Take-off minima should be expressed as visibility or runway visual range (RVR) limits, taking into account all relevant factors for each aerodrome planned to be used and aircraft characteristics. Where there is a specific need to see and avoid obstacles on departure and/or for a forced landing, additional conditions, e.g. ceiling, should be specified.
- (2) The commander should not commence take-off unless the weather conditions at the aerodrome of departure are equal to or better than applicable minima for landing at that aerodrome unless a weather-permissible take-off alternate aerodrome is available.
- (3) When the reported meteorological visibility (VIS) is below that required for take-off and RVR is not reported, a take-off should only be commenced if the commander can determine that the visibility along the take-off runway is equal to or better than the required minimum.
- (4) When no reported meteorological visibility or RVR is available, a take-off should only be commenced if the commander can determine that the visibility along the take-off runway is equal to or better than the required minimum.

(b) Visual reference

- (1) The take-off minima should be selected to ensure sufficient guidance to control the aircraft in the event of both a rejected take-off in adverse circumstances and a continued take-off after failure of the critical engine.
- (2) For night operations, ground lights should be available to illuminate the runway and any obstacles.

(c) Required RVR/VIS — aeroplanes

- (1) For multi-engined aeroplanes, with performance such that in the event of a critical engine failure at any point during take-off the aeroplane can either stop or continue the take-off to a height of 1 500 ft above the aerodrome while clearing obstacles by the required margins, the take-off minima specified by the operator should be expressed as RVR/CMV (converted meteorological visibility) values not lower than those specified in Table 1.A.
- (2) For multi-engined aeroplanes without the performance to comply with the conditions in (c)(1) in the event of a critical engine failure, there may be a need to re-land immediately and to see and avoid obstacles in the take-off area. Such aeroplanes may be operated to the following take-off minima provided they are able to comply with the applicable obstacle clearance criteria, assuming engine failure at the height specified. The take-off minima specified by the operator should be based upon the height from which the one-engine-

inoperative (OEI) net take-off flight path can be constructed. The RVR minima used should not be lower than either of the values specified in Table 1.A or Table 2.A.

- (3) When RVR or meteorological visibility is not available, the commander should not commence take-off unless he/she can determine that the actual conditions satisfy the applicable take-off minima.

Table 1.A

Take-off — aeroplanes (without an approval for low visibility take-off (LVTO))
RVR/VIS

Facilities	RVR/VIS (m) *
Day only: Nil**	500
Day: at least runway edge lights or runway centreline markings Night: at least runway edge lights and runway end lights or runway centreline lights and runway end lights	400

*: The reported RVR/VIS value representative of the initial part of the take-off run can be replaced by pilot assessment.

** : The pilot is able to continuously identify the take-off surface and maintain directional control.

Table 2.A

Take-off — aeroplanes
Assumed engine failure height above the runway versus RVR/VIS

Assumed engine failure height above the take-off runway (ft)	RVR/VIS (m) **
<50	400 (200 with LVTO approval)
51 – 100	400 (300 with LVTO approval)
101 – 150	400
151 – 200	500
201 – 300	1 000
>300 *	1 500

*: 1 500 m is also applicable if no positive take-off flight path can be constructed.

** : The reported RVR/VIS value representative of the initial part of the take-off run can be replaced by pilot assessment.

AMC2 CAT.OP.MPA.110 Aerodrome operating minima

TAKE-OFF OPERATIONS — HELICOPTERS

(a) General

- (1) Take-off minima should be expressed as visibility or runway visual range (RVR) limits, taking into account all relevant factors for each aerodrome planned to be used and aircraft characteristics. Where there is a specific need to see and avoid obstacles on departure and/or for a forced landing, additional conditions, e.g. ceiling, should be specified.
- (2) The commander should not commence take-off unless the weather conditions at the aerodrome of departure are equal to or better than applicable minima for landing at that aerodrome unless a weather-permissible take-off alternate aerodrome is available.
- (3) When the reported meteorological visibility (VIS) is below that required for take-off and RVR is not reported, a take-off should only be commenced if the commander can determine that the visibility along the take-off runway/area is equal to or better than the required minimum.
- (4) When no reported meteorological visibility or RVR is available, a take-off should only be commenced if the commander can determine that the visibility along the take-off runway/area is equal to or better than the required minimum.

(b) Visual reference

- (1) The take-off minima should be selected to ensure sufficient guidance to control the aircraft in the event of both a rejected take-off in adverse circumstances and a continued take-off after failure of the critical engine.
- (2) For night operations, ground lights should be available to illuminate the runway/final approach and take-off area (FATO) and any obstacles.

(c) Required RVR/VIS — helicopters:

- (1) For performance class 1 operations, the operator should specify an RVR/VIS as take-off minima in accordance with Table 1.H.
- (2) For performance class 2 operations onshore, the commander should operate to take-off minima of 800 m RVR/VIS and remain clear of cloud during the take-off manoeuvre until reaching performance class 1 capabilities.
- (3) For performance class 2 operations offshore, the commander should operate to minima not less than that for performance class 1 and remain clear of cloud during the take-off manoeuvre until reaching performance class 1 capabilities.
- (4) Table 8 for converting reported meteorological visibility to RVR should not be used for calculating take-off minima.

Table 1.H

Take-off — helicopters (without LVTO approval)

RVR/VIS

Onshore aerodromes with instrument flight rules (IFR) departure procedures	RVR/VIS (m)
---	--------------------

No light and no markings (day only)	400 or the rejected take-off distance, whichever is the greater
No markings (night)	800
Runway edge/FATO light and centreline marking	400
Runway edge/FATO light, centreline marking and relevant RVR information	400
Offshore helideck *	
Two-pilot operations	400
Single-pilot operations	500

*: The take-off flight path to be free of obstacles.

AMC3 CAT.OP.MPA.110 Aerodrome operating minima

NPA, APV, CAT I OPERATIONS

- (a) The decision height (DH) to be used for a non-precision approach (NPA) flown with the continuous descent final approach (CDFA) technique, approach procedure with vertical guidance (APV) or category (CAT) I operation should not be lower than the highest of:
- (1) the minimum height to which the approach aid can be used without the required visual reference;
 - (2) the obstacle clearance height (OCH) for the category of aircraft;
 - (3) the published approach procedure DH where applicable;
 - (4) the system minimum specified in Table 3; or
 - (5) the minimum DH specified in the aircraft flight manual (AFM) or equivalent document, if stated.
- (b) The minimum descent height (MDH) for an NPA operation flown without the CDFA technique should not be lower than the highest of:
- (1) the OCH for the category of aircraft;
 - (2) the system minimum specified in Table 3; or
 - (3) the minimum MDH specified in the AFM, if stated.

Table 3

System minima

Facility	Lowest DH/MDH (ft)
ILS/MLS/GLS	200
GNSS/SBAS (LPV)	200

Facility	Lowest DH/MDH (ft)
GNSS (LNAV)	250
GNSS/Baro-VNAV (LNAV/ VNAV)	250
LOC with or without DME	250
SRA (terminating at ½ NM)	250
SRA (terminating at 1 NM)	300
SRA (terminating at 2 NM or more)	350
VOR	300
VOR/DME	250
NDB	350
NDB/DME	300
VDF	350

DME: distance measuring equipment;

GNSS: global navigation satellite system;

ILS: instrument landing system;

LNAV: lateral navigation;

LOC: localiser;

LPV: localiser performance with vertical guidance

SBAS: satellite-based augmentation system;

SRA: surveillance radar approach;

VDF: VHF direction finder;

VNAV: vertical navigation;

VOR: VHF omnidirectional radio range.

AMC4 CAT.OP.MPA.110 Aerodrome operating minima

CRITERIA FOR ESTABLISHING RVR/CMV

(a) Aeroplanes

The following criteria for establishing RVR/CMV should apply:

- (1) In order to qualify for the lowest allowable values of RVR/CMV specified in Table 6.A, the instrument approach should meet at least the following facility specifications and associated conditions:

- (i) Instrument approaches with designated vertical profile up to and including 4.5° for category A and B aeroplanes, or 3.77° for category C and D aeroplanes where the facilities are:
 - (A) ILS/microwave landing system (MLS)/GBAS landing system (GLS)/precision approach radar (PAR); or
 - (B) APV; and

where the final approach track is offset by not more than 15° for category A and B aeroplanes or by not more than 5° for category C and D aeroplanes.
 - (ii) Instrument approach operations flown using the CDFA technique with a nominal vertical profile, up to and including 4.5° for category A and B aeroplanes, or 3.77° for category C and D aeroplanes, where the facilities are NDB, NDB/DME, VOR, VOR/DME, LOC, LOC/DME, VDF, SRA or GNSS/LNAV, with a final approach segment of at least 3 NM, which also fulfil the following criteria:
 - (A) the final approach track is offset by not more than 15° for category A and B aeroplanes or by not more than 5° for category C and D aeroplanes;
 - (B) the final approach fix (FAF) or another appropriate fix where descent is initiated is available, or distance to threshold (THR) is available by flight management system/GNSS (FMS/GNSS) or DME; and
 - (C) if the missed approach point (MAPt) is determined by timing, the distance from FAF or another appropriate fix to THR is ≤ 8 NM.
 - (iii) Instrument approaches where the facilities are NDB, NDB/DME, VOR, VOR/DME, LOC, LOC/DME, VDF, SRA or GNSS/LNAV, not fulfilling the criteria in (a)(1)(ii), or with an MDH ≥ 1 200 ft.
- (2) The missed approach operation, after an approach operation has been flown using the CDFA technique, should be executed when reaching the DA/H or the MAPt, whichever occurs first. The lateral part of the missed approach procedure should be flown via the MAPt unless otherwise stated on the approach chart.

AMC5 CAT.OP.MPA.110 Aerodrome operating minima

DETERMINATION OF RVR/CMV/VIS MINIMA FOR NPA, APV, CAT I — AEROPLANES

(a) Aeroplanes

The RVR/CMV/VIS minima for NPA, APV and CAT I operations should be determined as follows:

- (1) The minimum RVR/CMV/VIS should be the highest of the values specified in Table 5 or Table 6.A, but not greater than the maximum values specified in Table 6.A, where applicable.
- (2) The values in Table 5 should be derived from the formula below,

$$\text{Required RVR/VIS (m)} = [(DH/MDH \text{ (ft)} \times 0.3048) / \tan \alpha] - \text{length of approach lights (m)}$$

where α is the calculation angle, being a default value of 3.00° increasing in steps of 0.10° for each line in Table 5 up to 3.77° and then remaining constant.
- (3) If the approach is flown with a level flight segment at or above MDA/H, 200 m should be added for category A and B aeroplanes and 400 m for category C and D aeroplanes to the minimum RVR/CMV/VIS value resulting from the application of Tables 5 and 6.A.

- (4) An RVR of less than 750 m as indicated in Table 5 may be used:
- (i) for CAT I operations to runways with full approach lighting system (FALS), runway touchdown zone lights (RTZL) and runway centreline lights (RCLL);
 - (ii) for CAT I operations to runways without RTZL and RCLL when using an approved head-up guidance landing system (HUDLS), or equivalent approved system, or when conducting a coupled approach or flight-director-flown approach to a DH. The ILS should not be published as a restricted facility; and
 - (iii) for APV operations to runways with FALS, RTZL and RCLL when using an approved head-up display (HUD).
- (5) Lower values than those specified in Table 5, for HUDLS and auto-land operations may be used if approved in accordance with Annex V (Part-SPA), Subpart E (SPA.LVO).
- (6) The visual aids should comprise standard runway day markings and approach and runway lights as specified in Table 4. The competent authority may approve that RVR values relevant to a basic approach lighting system (BALS) are used on runways where the approach lights are restricted in length below 210 m due to terrain or water, but where at least one cross-bar is available.
- (7) For night operations or for any operation where credit for runway and approach lights is required, the lights should be on and serviceable except as provided for in Table 9.
- (8) For single-pilot operations, the minimum RVR/VIS should be calculated in accordance with the following additional criteria:
- (i) an RVR of less than 800 m as indicated in Table 5 may be used for CAT I approaches provided any of the following is used at least down to the applicable DH:
 - (A) a suitable autopilot, coupled to an ILS, MLS or GLS that is not published as restricted; or
 - (B) an approved HUDLS, including, where appropriate, enhanced vision system (EVS), or equivalent approved system;
 - (ii) where RTZL and/or RCLL are not available, the minimum RVR/CMV should not be less than 600 m; and
 - (iii) an RVR of less than 800 m as indicated in Table 5 may be used for APV operations to runways with FALS, RTZL and RCLL when using an approved HUDLS, or equivalent approved system, or when conducting a coupled approach to a DH equal to or greater than 250 ft.

Table 4

Approach lighting systems

Class of lighting facility	Length, configuration and intensity of approach lights
FALS	CAT I lighting system (HIALS ≥ 720 m) distance coded centreline, Barrette centreline
IALS	Simple approach lighting system (HIALS 420 – 719 m) single source, Barrette
BALS	Any other approach lighting system (HIALS, MALS or ALS 210 - 419 m)

Class of lighting facility	Length, configuration and intensity of approach lights
NALS	Any other approach lighting system (HIALS, MALS or ALS <210 m) or no approach lights

Note: HIALS: high intensity approach lighting system;
MALS: medium intensity approach lighting system.

Table 5

RVR/CMV vs DH/MDH

DH or MDH			Class of lighting facility			
			FALS	IALS	BALS	NALS
			See (a)(4),(5),(8) above for RVR <750/800 m			
ft			RVR/CMV (m)			
200	-	210	550	750	1 000	1 200
211	-	220	550	800	1 000	1 200
221	-	230	550	800	1 000	1 200
231	-	240	550	800	1 000	1 200
241	-	250	550	800	1 000	1 300
251	-	260	600	800	1 100	1 300
261	-	280	600	900	1 100	1 300
281	-	300	650	900	1 200	1 400
301	-	320	700	1 000	1 200	1 400
321	-	340	800	1 100	1 300	1 500
341	-	360	900	1 200	1 400	1 600
361	-	380	1 000	1 300	1 500	1 700
381	-	400	1 100	1 400	1 600	1 800
401	-	420	1 200	1 500	1 700	1 900
421	-	440	1 300	1 600	1 800	2 000
441	-	460	1 400	1 700	1 900	2 100
461	-	480	1 500	1 800	2 000	2 200
481		500	1 500	1 800	2 100	2 300
501	-	520	1 600	1 900	2 100	2 400
521	-	540	1 700	2 000	2 200	2 400

DH or MDH			Class of lighting facility			
			FALS	IALS	BALS	NALS
			See (a)(4),(5),(8) above for RVR <750/800 m			
ft			RVR/CMV (m)			
541	-	560	1 800	2 100	2 300	2 500
561	-	580	1 900	2 200	2 400	2 600
581	-	600	2 000	2 300	2 500	2 700
601	-	620	2 100	2 400	2 600	2 800
621	-	640	2 200	2 500	2 700	2 900
641	-	660	2 300	2 600	2 800	3 000
661	-	680	2 400	2 700	2 900	3 100
681	-	700	2 500	2 800	3 000	3 200
701	-	720	2 600	2 900	3 100	3 300
721	-	740	2 700	3 000	3 200	3 400
741	-	760	2 700	3 000	3 300	3 500
761	-	800	2 900	3 200	3 400	3 600
801	-	850	3 100	3 400	3 600	3 800
851	-	900	3 300	3 600	3 800	4 000
901	-	950	3 600	3 900	4 100	4 300
951	-	1 000	3 800	4 100	4 300	4 500
1 001	-	1 100	4 100	4 400	4 600	4 900
1 101	-	1 200	4 600	4 900	5 000	5 000
1 201 and above			5 000	5 000	5 000	5 000

Table 6.A

CAT I, APV, NPA — aeroplanes

Minimum and maximum applicable RVR/CMV (lower and upper cut-off limits)

Facility/conditions	RVR/CMV (m)	Aeroplane category			
		A	B	C	D
ILS, MLS, GLS, PAR, GNSS/SBAS, GNSS/VNAV	Min	According to Table 5			
	Max	1 500	1 500	2 400	2 400
NDB, NDB/DME, VOR, VOR/DME, LOC, LOC/DME, VDF, SRA, GNSS/LNAV with a procedure that fulfils the criteria in AMC4 CAT.OP.MPA.110, (a)(1)(ii)	Min	750	750	750	750
	Max	1 500	1 500	2 400	2 400
For NDB, NDB/DME, VOR, VOR/DME, LOC, LOC/DME, VDF, SRA, GNSS/LNAV: — not fulfilling the criteria in in AMC4 CAT.OP.MPA.110, (a)(1)(ii), or — with a DH or MDH \geq 1 200 ft	Min	1 000	1 000	1 200	1 200
	Max	According to Table 5, if flown using the CDFA technique, otherwise an add-on of 200 m for Category A and B aeroplanes and 400 m for Category C and D aeroplanes applies to the values in Table 5 but not to result in a value exceeding 5 000 m.			

AMC6 CAT.OP.MPA.110 Aerodrome operating minima

DETERMINATION OF RVR/CMV/VIS MINIMA FOR NPA, CAT I — HELICOPTERS

(a) Helicopters

The RVR/CMV/VIS minima for NPA, APV and CAT I operations should be determined as follows:

- (1) For NPA operations operated in performance class 1 (PC1) or performance class 2 (PC2), the minima specified in Table 6.1.H should apply:
 - (i) where the missed approach point is within $\frac{1}{2}$ NM of the landing threshold, the approach minima specified for FALS may be used regardless of the length of approach lights available. However, FATO/runway edge lights, threshold lights, end lights and FATO/runway markings are still required;
 - (ii) for night operations, ground lights should be available to illuminate the FATO/runway and any obstacles; and

- (iii) for single-pilot operations, the minimum RVR is 800 m or the minima in Table 6.1.H, whichever is higher.
- (2) For CAT I operations operated in PC1 or PC2, the minima specified in Table 6.2.H should apply:
 - (i) for night operations, ground light should be available to illuminate the FATO/runway and any obstacles;
 - (ii) for single-pilot operations, the minimum RVR/VIS should be calculated in accordance with the following additional criteria:
 - (A) an RVR of less than 800 m should not be used except when using a suitable autopilot coupled to an ILS, MLS or GLS, in which case normal minima apply; and
 - (B) the DH applied should not be less than 1.25 times the minimum use height for the autopilot.

Table 6.1.H

Onshore NPA minima

MDH (ft) *	Facilities vs RVR/CMV (m) **, ***			
	FALS	IALS	BALS	NALS
250 – 299	600	800	1 000	1 000
300 – 449	800	1 000	1 000	1 000
450 and above	1 000	1 000	1 000	1 000

*: The MDH refers to the initial calculation of MDH. When selecting the associated RVR, there is no need to take account of a rounding up to the nearest 10 ft, which may be done for operational purposes, e.g. conversion to MDA.

** : The tables are only applicable to conventional approaches with a nominal descent slope of not greater than 4°. Greater descent slopes will usually require that visual glide slope guidance (e.g. precision approach path indicator (PAPI)) is also visible at the MDH.

***: FALS comprise FATO/runway markings, 720 m or more of high intensity/medium intensity (HI/MI) approach lights, FATO/runway edge lights, threshold lights and FATO/runway end lights. Lights to be on.

IALS comprise FATO/runway markings, 420 - 719 m of HI/MI approach lights, FATO/runway edge lights, threshold lights and FATO/runway end lights. Lights to be on.

BALS comprise FATO/runway markings, <420 m of HI/MI approach lights, any length of low intensity (LI) approach lights, FATO/runway edge lights, threshold lights and FATO/runway end lights. Lights to be on.

NALS comprise FATO/runway markings, FATO/runway edge lights, threshold lights, FATO/runway end lights or no lights at all.

Table 6.2.H

Onshore CAT I minima

DH (ft) *	Facilities vs RVR/CMV (m) **, ***			
	FALS	IALS	BALS	NALS
200	500	600	700	1 000
201 – 250	550	650	750	1 000
251 – 300	600	700	800	1 000
301 and above	750	800	900	1 000

*: The DH refers to the initial calculation of DH. When selecting the associated RVR, there is no need to take account of a rounding up to the nearest 10 ft, which may be done for operational purposes, e.g. conversion to DA.

** : The table is applicable to conventional approaches with a glide slope up to and including 4°.

***: FALS comprise FATO/runway markings, 720 m or more of HI/MI approach lights, FATO/runway edge lights, threshold lights and FATO/runway end lights. Lights to be on.

IALS comprise FATO/runway markings, 420 - 719 m of HI/MI approach lights, FATO/runway edge lights, threshold lights and FATO/runway end lights. Lights to be on.

BALS comprise FATO/runway markings, <420 m of HI/MI approach lights, any length of LI approach lights, FATO/runway edge lights, threshold lights and FATO/runway end lights. Lights to be on.

NALS comprise FATO/runway markings, FATO/runway edge lights, threshold lights, FATO/runway end lights or no lights at all.

AMC7 CAT.OP.MPA.110 Aerodrome operating minima

CIRCLING OPERATIONS — AEROPLANES

(a) Circling minima

The following standards should apply for establishing circling minima for operations with aeroplanes:

- (1) the MDH for circling operation should not be lower than the highest of:
 - (i) the published circling OCH for the aeroplane category;
 - (ii) the minimum circling height derived from Table 7; or
 - (iii) the DH/MDH of the preceding instrument approach procedure;
- (2) the MDA for circling should be calculated by adding the published aerodrome elevation to the MDH, as determined by (a)(1); and
- (3) the minimum visibility for circling should be the highest of:
 - (i) the circling visibility for the aeroplane category, if published;
 - (ii) the minimum visibility derived from Table 7; or

- (iii) the RVR/CMV derived from Tables 5 and 6.A for the preceding instrument approach procedure.

Table 7

Circling — aeroplanes

MDH and minimum visibility vs aeroplane category

	Aeroplane category			
	A	B	C	D
MDH (ft)	400	500	600	700
Minimum meteorological visibility (m)	1 500	1 600	2 400	3 600

- (b) Conduct of flight — general:
- (1) the MDH and OCH included in the procedure are referenced to aerodrome elevation;
 - (2) the MDA is referenced to mean sea level;
 - (3) for these procedures, the applicable visibility is the meteorological visibility; and
 - (4) operators should provide tabular guidance of the relationship between height above threshold and the in-flight visibility required to obtain and sustain visual contact during the circling manoeuvre.
- (c) Instrument approach followed by visual manoeuvring (circling) without prescribed tracks
- (1) When the aeroplane is on the initial instrument approach, before visual reference is stabilised, but not below MDA/H, the aeroplane should follow the corresponding instrument approach procedure until the appropriate instrument MAPt is reached.
 - (2) At the beginning of the level flight phase at or above the MDA/H, the instrument approach track determined by radio navigation aids, RNAV, RNP, ILS, MLS or GLS should be maintained until the pilot:
 - (i) estimates that, in all probability, visual contact with the runway of intended landing or the runway environment will be maintained during the entire circling procedure;
 - (ii) estimates that the aeroplane is within the circling area before commencing circling; and
 - (iii) is able to determine the aeroplane's position in relation to the runway of intended landing with the aid of the appropriate external references.
 - (3) When reaching the published instrument MAPt and the conditions stipulated in (c)(2) are unable to be established by the pilot, a missed approach should be carried out in accordance with that instrument approach procedure.
 - (4) After the aeroplane has left the track of the initial instrument approach, the flight phase outbound from the runway should be limited to an appropriate distance, which is required to align the aeroplane onto the final approach. Such manoeuvres should be conducted to enable the aeroplane:
 - (i) to attain a controlled and stable descent path to the intended landing runway; and
 - (ii) to remain within the circling area and in such way that visual contact with the runway of intended landing or runway environment is maintained at all times.

- (5) Flight manoeuvres should be carried out at an altitude/height that is not less than the circling MDA/H.
 - (6) Descent below MDA/H should not be initiated until the threshold of the runway to be used has been appropriately identified. The aeroplane should be in a position to continue with a normal rate of descent and land within the touchdown zone.
- (d) Instrument approach followed by a visual manoeuvring (circling) with prescribed track
- (1) The aeroplane should remain on the initial instrument approach procedure until one of the following is reached:
 - (i) the prescribed divergence point to commence circling on the prescribed track; or
 - (ii) the MAPt.
 - (2) The aeroplane should be established on the instrument approach track determined by the radio navigation aids, RNAV, RNP, ILS, MLS or GLS in level flight at or above the MDA/H at or by the circling manoeuvre divergence point.
 - (3) If the divergence point is reached before the required visual reference is acquired, a missed approach should be initiated not later than the MAPt and completed in accordance with the instrument approach procedure.
 - (4) When commencing the prescribed circling manoeuvre at the published divergence point, the subsequent manoeuvres should be conducted to comply with the published routing and published heights/altitudes.
 - (5) Unless otherwise specified, once the aeroplane is established on the prescribed track(s), the published visual reference does not need to be maintained unless:
 - (i) required by the State of the aerodrome; or
 - (ii) the circling MAPt (if published) is reached.
 - (6) If the prescribed circling manoeuvre has a published MAPt and the required visual reference has not been obtained by that point, a missed approach should be executed in accordance with (e)(2) and (e)(3).
 - (7) Subsequent further descent below MDA/H should only commence when the required visual reference has been obtained.
 - (8) Unless otherwise specified in the procedure, final descent should not be commenced from MDA/H until the threshold of the intended landing runway has been identified and the aeroplane is in a position to continue with a normal rate of descent to land within the touchdown zone.
- (e) Missed approach
- (1) Missed approach during the instrument procedure prior to circling:
 - (i) if the missed approach procedure is required to be flown when the aeroplane is positioned on the instrument approach track defined by radio-navigation aids RNAV, RNP, or ILS, MLS, and before commencing the circling manoeuvre, the published missed approach for the instrument approach should be followed; or
 - (ii) if the instrument approach procedure is carried out with the aid of an ILS, MLS or an stabilised approach (SAP), the MAPt associated with an ILS, MLS procedure without glide path (GP-out procedure) or the SAP, where applicable, should be used.

- (2) If a prescribed missed approach is published for the circling manoeuvre, this overrides the manoeuvres prescribed below.
- (3) If visual reference is lost while circling to land after the aeroplane has departed from the initial instrument approach track, the missed approach specified for that particular instrument approach should be followed. It is expected that the pilot will make an initial climbing turn toward the intended landing runway to a position overhead the aerodrome where the pilot will establish the aeroplane in a climb on the instrument missed approach segment.
- (4) The aeroplane should not leave the visual manoeuvring (circling) area, which is obstacle-protected, unless:
 - (i) established on the appropriate missed approach procedure; or
 - (ii) at minimum sector altitude (MSA).
- (5) All turns should be made in the same direction and the aeroplane should remain within the circling protected area while climbing either:
 - (i) to the altitude assigned to any published circling missed approach manoeuvre if applicable;
 - (ii) to the altitude assigned to the missed approach of the initial instrument approach;
 - (iii) to the MSA; or
 - (iv) to the minimum holding altitude (MHA) applicable to transition to a holding facility or fix, or continue to climb to an MSA;

or as directed by ATS.

When the missed approach procedure is commenced on the 'downwind' leg of the circling manoeuvre, an 'S' turn may be undertaken to align the aeroplane on the initial instrument approach missed approach path, provided the aeroplane remains within the protected circling area.

The commander should be responsible for ensuring adequate terrain clearance during the above-stipulated manoeuvres, particularly during the execution of a missed approach initiated by ATS.

- (6) Because the circling manoeuvre may be accomplished in more than one direction, different patterns will be required to establish the aeroplane on the prescribed missed approach course depending on its position at the time visual reference is lost. In particular, all turns are to be in the prescribed direction if this is restricted, e.g. to the west/east (left or right hand) to remain within the protected circling area.
- (7) If a missed approach procedure is published for a particular runway onto which the aeroplane is conducting a circling approach and the aeroplane has commenced a manoeuvre to align with the runway, the missed approach for this direction may be accomplished. The ATS unit should be informed of the intention to fly the published missed approach procedure for that particular runway.
- (8) The commander should advise ATS when any missed approach procedure has been commenced, the height/altitude the aeroplane is climbing to and the position the aeroplane is proceeding towards and/or heading the aeroplane is established on.

AMC8 CAT.OP.MPA.110 Aerodrome operating minima

ONSHORE CIRCLING OPERATIONS — HELICOPTERS

For circling, the specified MDH should not be less than 250 ft, and the meteorological visibility not less than 800 m.

AMC9 CAT.OP.MPA.110 Aerodrome operating minima

VISUAL APPROACH OPERATIONS

The operator should not use an RVR of less than 800 m for a visual approach operation.

AMC10 CAT.OP.MPA.110 Aerodrome operating minima

CONVERSION OF REPORTED METEOROLOGICAL VISIBILITY TO RVR

- (a) A conversion from meteorological visibility to RVR/CMV should not be used:
- (1) when reported RVR is available;
 - (2) for calculating take-off minima; and
 - (3) for any RVR minima less than 800 m.
- (b) If the RVR is reported as being above the maximum value assessed by the aerodrome operator, e.g. 'RVR more than 1 500 m', it should not be considered as a reported value for (a)(1).
- (c) When converting meteorological visibility to RVR in circumstances other than those in (a), the conversion factors specified in Table 8 should be used.

Table 8

Conversion of reported meteorological visibility to RVR/CMV

Light elements in operation	RVR/CMV = reported meteorological visibility x	
	Day	Night
HI approach and runway lights	1.5	2.0
Any type of light installation other than above	1.0	1.5
No lights	1.0	not applicable

AMC11 CAT.OP.MPA.110 Aerodrome operating minima

EFFECT ON LANDING MINIMA OF TEMPORARILY FAILED OR DOWNGRADED GROUND EQUIPMENT

- (a) General

These instructions are intended for use both pre-flight and in-flight. It is, however, not expected that the commander would consult such instructions after passing 1 000 ft above the aerodrome. If failures of ground aids are announced at such a late stage, the approach could be continued at the commander's discretion. If failures are announced before such a late stage in the approach, their effect on the approach should be considered as described in Table 9, and the approach may have to be abandoned.

(b) Conditions applicable to Table 9:

- (1) multiple failures of runway/FATO lights other than indicated in Table 9 should not be acceptable;
- (2) deficiencies of approach and runway/FATO lights are treated separately; and
- (3) failures other than ILS, MLS affect RVR only and not DH.

Table 9

Failed or downgraded equipment — effect on landing minima
Operations without a low visibility operations (LVO) approval

Failed or downgraded equipment	Effect on landing minima	
	CAT I	APV, NPA
ILS/MLS stand-by transmitter	No effect	
Outer Marker	Not allowed except if replaced by height check at 1 000 ft	APV — not applicable
		NPA with FAF: no effect unless used as FAF
		If the FAF cannot be identified (e.g. no method available for timing of descent), non-precision operations cannot be conducted
Middle marker	No effect	No effect unless used as MAPt
RVR Assessment Systems	No effect	
Approach lights	Minima as for NALS	
Approach lights except the last 210 m	Minima as for BALS	
Approach lights except the last 420 m	Minima as for IALS	
Standby power for approach lights	No effect	
Edge lights, threshold lights and runway end lights	Day: no effect; Night: not allowed	
Centreline lights	No effect if F/D, HUDLS or auto-land otherwise RVR 750 m	No effect
Centreline lights spacing increased to 30 m	No effect	

Failed or downgraded equipment	Effect on landing minima	
	CAT I	APV, NPA
Touchdown zone lights	No effect if F/D, HUDLS or auto-land; otherwise RVR 750 m	No effect
Taxiway lighting system	No effect	

AMC12 CAT.OP.MPA.110 Aerodrome operating minima

VFR OPERATIONS WITH OTHER-THAN-COMPLEX MOTOR-POWERED AIRCRAFT

For the establishment of VFR operation minima, the operator may apply the VFR operating minima specified in Part-SERA. Where necessary, the operator may specify in the OM additional conditions for the applicability of such minima taking into account such factors as radio coverage, terrain, nature of sites for take-off and landing, flight conditions and ATS capacity.

GM1 CAT.OP.MPA.110 Aerodrome operating minima

ONSHORE AERODROME DEPARTURE PROCEDURES — HELICOPTERS

The cloud base and visibility should be such as to allow the helicopter to be clear of cloud at take-off decision point (TDP), and for the pilot flying to remain in sight of the surface until reaching the minimum speed for flight in instrument meteorological conditions (IMC) given in the AFM.

GM2 CAT.OP.MPA.110 Aerodrome operating minima

APPROACH LIGHTING SYSTEMS — ICAO, FAA

The following table provides a comparison of ICAO and FAA specifications.

Table 1

Approach lighting systems

Class of lighting facility	Length, configuration and intensity of approach lights
FALS	ICAO: CAT I lighting system (HIALS \geq 900 m) distance coded centreline, Barrette centreline FAA: ALSF1, ALSF2, SSALR, MALSR, high or medium intensity and/or flashing lights, 720 m or more
IALS	ICAO: simple approach lighting system (HIALS 420 – 719 m) single source, Barrette FAA: MALSF, MALS, SALS/SALSF, SSALF, SSALS, high or medium intensity and/or flashing lights, 420 – 719 m
BALS	Any other approach lighting system (HIALS, MALS or ALS 210-419 m) FAA: ODALS, high or medium intensity or flashing lights 210 - 419 m
NALS	Any other approach lighting system (HIALS, MALS or ALS $<$ 210 m) or no approach lights

Note: ALSF: approach lighting system with sequenced flashing lights;

MALS: medium intensity approach lighting system;

MALSF: medium intensity approach lighting system with sequenced flashing lights;

MALSR: medium intensity approach lighting system with runway alignment indicator lights;

ODALS: omnidirectional approach lighting system;

SALS: simple approach lighting system;

SALSF: short approach lighting system with sequenced flashing lights;

SSALF: simplified short approach lighting system with sequenced flashing lights;

SSALR: simplified short approach lighting system with runway alignment indicator lights;

SSALS: simplified short approach lighting system.

GM3 CAT.OP.MPA.110 Aerodrome operating minima

SBAS OPERATIONS

- (a) SBAS CAT I operations with a DH of 200 ft depend on an SBAS system approved for operations down to a DH of 200 ft.
- (b) The following systems are in operational use or in a planning phase:
 - (1) European geostationary navigation overlay service (EGNOS) operational in Europe;
 - (2) wide area augmentation system (WAAS) operational in the USA;
 - (3) multi-functional satellite augmentation system (MSAS) operational in Japan;
 - (4) system of differential correction and monitoring (SDCM) planned by Russia;

-
- (5) GPS aided geo augmented navigation (GAGAN) system, planned by India; and
 - (6) satellite navigation augmentation system (SNAS), planned by China.

GM1 CAT.OP.MPA.110(a) Aerodrome operating minima

INCREMENTS SPECIFIED BY THE COMPETENT AUTHORITY

Additional increments to the published minima may be specified by the competent authority to take into account certain operations, such as downwind approaches and single-pilot operations.

CAT.OP.MPA.115 Approach flight technique — aeroplanes

- (a) All approaches shall be flown as stabilised approaches unless otherwise approved by the competent authority for a particular approach to a particular runway.
- (b) Non-precision approaches
 - (1) The continuous descent final approach (CDFA) technique shall be used for all non-precision approaches.
 - (2) Notwithstanding (1), another approach flight technique may be used for a particular approach/runway combination if approved by the competent authority. In such cases, the applicable minimum runway visual range (RVR):
 - (i) shall be increased by 200 m for category A and B aeroplanes and by 400 m for category C and D aeroplanes; or
 - (ii) for aerodromes where there is a public interest to maintain current operations and the CDFA technique cannot be applied, shall be established and regularly reviewed by the competent authority taking into account the operator's experience, training programme and flight crew qualification.

AMC1 CAT.OP.MPA.115 Approach flight technique — aeroplanes

CONTINUOUS DESCENT FINAL APPROACH (CDFA)

- (a) Flight techniques:
 - (1) The CDFA technique should ensure that an approach can be flown on the desired vertical path and track in a stabilised manner, without significant vertical path changes during the final segment descent to the runway. This technique applies to an approach with no vertical guidance and controls the descent path until the DA/DH. This descent path can be either:
 - (i) a recommended descent rate, based on estimated ground speed;
 - (ii) a descent path depicted on the approach chart; or
 - (iii) a descent path coded in the flight management system in accordance with the approach chart descent path.
 - (2) The operator should either provide charts which depict the appropriate cross check altitudes/heights with the corresponding appropriate range information, or such information should be calculated and provided to the flight crew in an appropriate and usable format. Generally, the MAPt is published on the chart.
 - (3) The approach should be flown as an SAp.
 - (4) The required descent path should be flown to the DA/H, observing any step-down crossing altitudes if applicable.
 - (5) This DA/H should take into account any add-on to the published minima as identified by the operator's management system and should be specified in the OM (aerodrome operating minima).
 - (6) During the descent, the pilot monitoring should announce crossing altitudes as published fixes and other designated points are crossed, giving the appropriate altitude or height for the appropriate range as depicted on the chart. The pilot flying should promptly adjust the rate of descent as appropriate.

- (7) The operator should establish a procedure to ensure that an appropriate callout is made when the aeroplane is approaching DA/H. If the required visual references are not established at DA/H, the missed approach procedure is to be executed promptly.
 - (8) The descent path should ensure that little or no adjustment of attitude or thrust/power is needed after the DA/H to continue the landing in the visual segment.
 - (9) The missed approach should be initiated no later than reaching the MAPt or at the DA/H, whichever comes first. The lateral part of the missed approach should be flown via the MAPt unless otherwise stated on the approach chart.
- (b) Flight techniques conditions:
- (1) The approach should be considered to be fully stabilised when the aeroplane is:
 - (i) tracking on the required approach path and profile;
 - (ii) in the required configuration and attitude;
 - (iii) flying with the required rate of descent and speed; and
 - (iv) flying with the appropriate thrust/power and trim.
 - (2) The aeroplane is considered established on the required approach path at the appropriate energy for stable flight using the CDFA technique when:
 - (i) it is tracking on the required approach path with the correct track set, approach aids tuned and identified as appropriate to the approach type flown and on the required vertical profile; and
 - (ii) it is at the appropriate attitude and speed for the required target rate of descent (ROD) with the appropriate thrust/power and trim.
 - (3) Stabilisation during any straight-in approach without visual reference to the ground should be achieved at the latest when passing 1 000 ft above runway threshold elevation. For approaches with a designated vertical profile applying the CDFA technique, a later stabilisation in speed may be acceptable if higher than normal approach speeds are required by ATC procedures or allowed by the OM. Stabilisation should, however, be achieved not later than 500 ft above runway threshold elevation.
 - (4) For approaches where the pilot has visual reference with the ground, stabilisation should be achieved not later than 500 ft above aerodrome elevation. However, the aeroplane should be stabilised when passing 1 000 ft above runway threshold elevation; in the case of circling approaches flown after a CDFA, the aircraft should be stabilised in the circling configuration not later than passing 1 000 ft above the runway elevation.
 - (5) To ensure that the approach can be flown in a stabilised manner, the bank angle, rate of descent and thrust/power management should meet the following performances:
 - (i) The bank angle should be less than 30 degrees.
 - (ii) The target rate of descent (ROD) should not exceed 1 000 fpm and the ROD deviations should not exceed ± 300 fpm, except under exceptional circumstances which have been anticipated and briefed prior to commencing the approach; for example, a strong tailwind. Zero ROD may be used when the descent path needs to be regained from below the profile. The target ROD may need to be initiated prior to reaching the required descent point, typically 0.3 NM before the descent point, dependent upon ground speed, which may vary for each type/class of aeroplane.

- (iii) The limits of thrust/power and the appropriate range should be specified in the OM Part B or equivalent document.
- (iv) The optimum angle for the approach slope is 3° and should not exceed 4.5°.
- (v) The CDFA technique should be applied only to approach procedures based on NDB, NDB/DME, VOR, VOR/DME, LOC, LOC/DME, VDF, SRA, GNSS/LNAV and fulfil the following criteria:
 - (A) the final approach track off-set $\leq 5^\circ$ except for Category A and B aeroplanes, where the approach-track off-set is $\leq 15^\circ$; and
 - (B) a FAF, or another appropriate fix, e.g. final approach point, where descent initiated is available; and
 - (C) the distance from the FAF or another appropriate fix to the threshold (THR) is less than or equal to 8 NM in the case of timing; or
 - (D) the distance to the THR is available by FMS/GNSS or DME; or
 - (E) the minimum final-segment of the designated constant angle approach path should not be less than 3 NM from the THR unless approved by the authority.
- (7) The CDFA techniques support a common method for the implementation of flight-director-guided or auto-coupled RNAV approaches.

AMC2 CAT.OP.MPA.115 Approach flight technique — aeroplanes

NPA OPERATIONS WITHOUT APPLYING THE CDFA TECHNIQUE

- (a) In case the CDFA technique is not used, the approach should be flown to an altitude/height at or above the MDA/H where a level flight segment at or above MDA/H may be flown to the MAPt.
- (b) Even when the approach procedure is flown without the CDFA technique, the relevant procedures for ensuring a controlled and stable path to MDA/H should be followed.
- (c) In case the CDFA technique is not used when flying an approach, the operator should implement procedures to ensure that early descent to the MDA/H will not result in a subsequent flight below MDA/H without adequate visual reference. These procedures could include:
 - (1) awareness of radio altimeter information with reference to the approach profile;
 - (2) terrain awareness warning system (TAWS);
 - (3) limitation of rate of descent;
 - (4) limitation of the number of repeated approaches;
 - (5) safeguards against too early descents with prolonged flight at MDA/H; and
 - (6) specification of visual requirements for the descent from the MDA/H.
- (d) In case the CDFA technique is not used and when the MDA/H is high, it may be appropriate to make an early descent to MDA/H with appropriate safeguards such as the application of a significantly higher RVR/VIS.
- (e) The procedures that are flown with level flight at/or above MDA/H should be listed in the OM.
- (f) Operators should categorise aerodromes where there are approaches that require level flight at/or above MDA/H as B and C. Such aerodrome categorisation will depend upon the operator's experience, operational exposure, training programme(s) and flight crew qualification(s).

AMC3 CAT.OP.MPA.115 Approach flight technique — aeroplanes

OPERATIONAL PROCEDURES AND INSTRUCTIONS AND TRAINING

- (a) The operator should establish procedures and instructions for flying approaches using the CDFA technique and not using it. These procedures should be included in the OM and should include the duties of the flight crew during the conduct of such operations.
- (b) The operator should at least specify in the OM the maximum ROD for each aeroplane type/class operated and the required visual reference to continue the approach below:
 - (1) the DA/H, when applying the CDFA technique; and
 - (2) the MDA/H, when not applying the CDFA technique.
- (c) The operator should establish procedures which prohibit level flight at MDA/H without the flight crew having obtained the required visual references. It is not the intention to prohibit level flight at MDA/H when conducting a circling approach, which does not come within the definition of the CDFA technique.
- (d) The operator should provide the flight crew with unambiguous details of the technique used (CDFA or not). The corresponding relevant minima should include:
 - (1) type of decision, whether DA/H or MDA/H;
 - (2) MAPt as applicable; and
 - (3) appropriate RVR/VIS for the approach operation and aeroplane category.
- (e) Training
 - (1) Prior to using the CDFA technique, each flight crew member should undertake appropriate training and checking as required by Subpart FC of Annex III (ORO.FC). The operator's proficiency check should include at least one approach to a landing or missed approach as appropriate using the CDFA technique or not. The approach should be operated to the lowest appropriate DA/H or MDA/H, as appropriate; and, if conducted in a FSTD, the approach should be operated to the lowest approved RVR. The approach is not in addition to any manoeuvre currently required by either Part-FCL or Part-CAT. The provision may be fulfilled by undertaking any currently required approach, engine out or otherwise, other than a precision approach (PA), whilst using the CDFA technique.
 - (2) The policy for the establishment of constant predetermined vertical path and approach stability is to be enforced both during initial and recurrent pilot training and checking. The relevant training procedures and instructions should be documented in the operations manual.
 - (3) The training should emphasise the need to establish and facilitate joint crew procedures and crew resource management (CRM) to enable accurate descent path control and the provision to establish the aeroplane in a stable condition as required by the operator's operational procedures.
 - (4) During training, emphasis should be placed on the flight crew's need to:
 - (i) maintain situational awareness at all times, in particular with reference to the required vertical and horizontal profile;
 - (ii) ensure good communication channels throughout the approach;
 - (iii) ensure accurate descent-path control particularly during any manually-flown descent phase. The monitoring pilot should facilitate good flight path control by:

- (A) communicating any altitude/height crosschecks prior to the actual passing of the range/altitude or height crosscheck;
 - (B) prompting, as appropriate, changes to the target ROD; and
 - (C) monitoring flight path control below DA/MDA;
 - (iv) understand the actions to be taken if the MAPt is reached prior to the MDA/H;
 - (v) ensure that the decision for a missed approach is taken no later than when reaching the DA/H or MDA/H;
 - (vi) ensure that prompt action for a missed approach is taken immediately when reaching DA/H if the required visual reference has not been obtained as there may be no obstacle protection if the missed approach procedure manoeuvre is delayed;
 - (vii) understand the significance of using the CDFA technique to a DA/H with an associated MAPt and the implications of early missed approach manoeuvres; and
 - (viii) understand the possible loss of the required visual reference due to pitch-change/climb when not using the CDFA technique for aeroplane types or classes that require a late change of configuration and/or speed to ensure the aeroplane is in the appropriate landing configuration.
- (5) Additional specific training when not using the CDFA technique with level flight at or above MDA/H
- (i) The training should detail:
 - (A) the need to facilitate CRM with appropriate flight crew communication in particular;
 - (B) the additional known safety risks associated with the 'dive-and-drive' approach philosophy which may be associated with non-CDFA;
 - (C) the use of DA/H during approaches flown using the CDFA technique;
 - (D) the significance of the MDA/H and the MAPt where appropriate;
 - (E) the actions to be taken at the MAPt and the need to ensure that the aeroplane remains in a stable condition and on the nominal and appropriate vertical profile until the landing;
 - (F) the reasons for increased RVR/Visibility minima when compared to the application of CDFA;
 - (G) the possible increased obstacle infringement risk when undertaking level flight at MDA/H without the required visual references;
 - (H) the need to accomplish a prompt missed approach manoeuvre if the required visual reference is lost;
 - (I) the increased risk of an unstable final approach and an associated unsafe landing if a rushed approach is attempted either from:
 - (a) inappropriate and close-in acquisition of the required visual reference; or
 - (b) unstable aeroplane energy and or flight path control; and
 - (J) the increased risk of controlled flight into terrain (CFIT).

GM1 CAT.OP.MPA.115 Approach flight technique — aeroplanes

CONTINUOUS DESCENT FINAL APPROACH (CDFA)

(a) Introduction

- (1) Controlled flight into terrain (CFIT) is a major hazard in aviation. Most CFIT accidents occur in the final approach segment of non-precision approaches; the use of stabilised-approach criteria on a continuous descent with a constant, predetermined vertical path is seen as a major improvement in safety during the conduct of such approaches. Operators should ensure that the following techniques are adopted as widely as possible, for all approaches.
- (2) The elimination of level flight segments at MDA close to the ground during approaches, and the avoidance of major changes in attitude and power/thrust close to the runway that can destabilise approaches, are seen as ways to reduce operational risks significantly.
- (3) The term CDFA has been selected to cover a flight technique for any type of NPA operation.
- (4) The advantages of CDFA are as follows:
 - (i) the technique enhances safe approach operations by the utilisation of standard operating practices;
 - (ii) the technique is similar to that used when flying an ILS approach, including when executing the missed approach and the associated missed approach procedure manoeuvre;
 - (iii) the aeroplane attitude may enable better acquisition of visual cues;
 - (iv) the technique may reduce pilot workload;
 - (v) the approach profile is fuel-efficient;
 - (vi) the approach profile affords reduced noise levels;
 - (vii) the technique affords procedural integration with APV operations; and
 - (viii) when used and the approach is flown in a stabilised manner, CDFA is the safest approach technique for all NPA operations.

(b) CDFA

- (1) Continuous descent final approach is defined in Annex I to this Regulation.
- (2) An approach is only suitable for application of a CDFA technique when it is flown along a nominal vertical profile: a nominal vertical profile is not forming part of the approach procedure design, but can be flown as a continuous descent. The nominal vertical profile information may be published or displayed on the approach chart to the pilot by depicting the nominal slope or range/distance vs height. Approaches with a nominal vertical profile are considered to be:
 - (i) NDB, NDB/DME;
 - (ii) VOR, VOR/DME;
 - (iii) LOC, LOC/DME;
 - (iv) VDF, SRA; or
 - (v) GNSS/LNAV.
- (3) Stabilised approach (SAp) is defined in Annex I to this Regulation.

-
- (i) The control of the descent path is not the only consideration when using the CDFA technique. Control of the aeroplane's configuration and energy is also vital to the safe conduct of an approach.
 - (ii) The control of the flight path, described above as one of the specifications for conducting an SAp, should not be confused with the path specifications for using the CDFA technique. The predetermined path specification for conducting an SAp are established by the operator and published in the operations manual part B.
 - (iii) The predetermined approach slope specifications for applying the CDFA technique are established by the following:
 - (A) the published 'nominal' slope information when the approach has a nominal vertical profile; and
 - (B) the designated final-approach segment minimum of 3 NM, and maximum, when using timing techniques, of 8 NM.
 - (iv) An SAp will never have any level segment of flight at DA/H or MDA/H as applicable. This enhances safety by mandating a prompt missed approach procedure manoeuvre at DA/H or MDA/H.
 - (v) An approach using the CDFA technique will always be flown as an SAp, since this is a specification for applying CDFA. However, an SAp does not have to be flown using the CDFA technique, for example, a visual approach.

CAT.OP.MPA.120 Airborne radar approaches (ARAs) for overwater operations — helicopters

Applicable until 1 July 2018, then deleted.

- (a) An ARA shall only be undertaken if:
- (1) the radar provides course guidance to ensure obstacle clearance; and
 - (2) either:
 - (i) the minimum descent height (MDH) is determined from a radio altimeter; or
 - (ii) the minimum descent altitude (MDA) plus an adequate margin is applied.
- (b) ARAs to rigs or vessels under way shall only be conducted in multi-crew operations.
- (c) The decision range shall provide adequate obstacle clearance in the missed approach from any destination for which an ARA is planned.
- (d) The approach shall only be continued beyond decision range or below MDA/H when visual reference with the destination has been established.
- (e) For single-pilot operations, appropriate increments shall be added to the MDA/H and decision range.

AMC1 CAT.OP.MPA.120 Airborne radar approaches (ARAs) for overwater operations — helicopters

Applicable until 1 July 2018, then deleted.

GENERAL

- (a) Before commencing the final approach the commander should ensure that a clear path exists on the radar screen for the final and missed approach segments. If lateral clearance from any obstacle is less than 1 NM, the commander should:
- (1) approach to a nearby target structure and thereafter proceed visually to the destination structure; or
 - (2) make the approach from another direction leading to a circling manoeuvre.
- (b) The cloud ceiling should be sufficiently clear above the helideck to permit a safe landing.
- (c) MDH should not be less than 50 ft above the elevation of the helideck.
- (1) The MDH for an airborne radar approach should not be lower than:
 - (i) 200 ft by day; or
 - (ii) 300 ft by night.
 - (2) The MDH for an approach leading to a circling manoeuvre should not be lower than:
 - (i) 300 ft by day; or
 - (ii) 500 ft by night.
- (d) MDA may only be used if the radio altimeter is unserviceable. The MDA should be a minimum of MDH +200 ft and should be based on a calibrated barometer at the destination or on the lowest forecast QNH for the region.
- (e) The decision range should not be less than $\frac{3}{4}$ NM.
- (f) The MDA/H for a single-pilot ARA should be 100 ft higher than that calculated using (c) and (d) above. The decision range should not be less than 1 NM.

Applicable until 1 July 2018, then deleted.

GM1 CAT.OP.MPA.120 Airborne radar approaches (ARAs) for overwater operations — helicopters

GENERAL

(a) General

- (1) The helicopter ARA procedure may have as many as five separate segments. These are the arrival, initial, intermediate, final and missed approach segments. In addition, the specifications of the circling manoeuvre to a landing under visual conditions should be considered. The individual approach segments can begin and end at designated fixes. However, the segments of an ARA may often begin at specified points where no fixes are available.
- (2) The fixes, or points, are named to coincide with the associated segment. For example, the intermediate segment begins at the intermediate fix (IF) and ends at the final approach fix (FAF). Where no fix is available or appropriate, the segments begin and end at specified points; for example, intermediate point (IP) and final approach point (FAP). The order in which this GM discusses the segments is the order in which the pilot would fly them in a complete procedure: that is, from the arrival through initial and intermediate to a final approach and, if necessary, the missed approach.
- (3) Only those segments that are required by local conditions applying at the time of the approach need to be included in a procedure. In constructing the procedure, the final approach track, which should be orientated so as to be substantially into wind should be identified first as it is the least flexible and most critical of all the segments. When the origin and the orientation of the final approach have been determined, the other necessary segments should be integrated with it to produce an orderly manoeuvring pattern that does not generate an unacceptably high workload for the flight crew.
- (4) Examples of ARA procedures, vertical profile and missed approach procedures are contained in Figures 1 to 5.

(b) Obstacle environment

- (1) Each segment of the ARA is located in an overwater area that has a flat surface at sea level. However, due to the passage of large vessels which are not required to notify their presence, the exact obstacle environment cannot be determined. As the largest vessels and structures are known to reach elevations exceeding 500 ft above mean sea level (AMSL), the uncontrolled offshore obstacle environment applying to the arrival, initial and intermediate approach segments can reasonably be assumed to be capable of reaching to at least 500 ft AMSL. But, in the case of the final approach and missed approach segments, specific areas are involved within which no radar returns are allowed. In these areas, the height of wave crests and the possibility that small obstacles may be present that are not visible on radar results in an uncontrolled surface environment that extends to an elevation of 50 ft AMSL.
- (2) Under normal circumstances, the relationship between the approach procedure and the obstacle environment is governed according to the concept that vertical separation is very easy to apply during the arrival, initial and intermediate segments, while horizontal separation, which is much more difficult to guarantee in an uncontrolled environment, is applied only in the final and missed approach segments.

(c) Arrival segment

The arrival segment commences at the last en-route navigation fix, where the aircraft leaves the helicopter route, and it ends either at the initial approach fix (IAF) or, if no course reversal, or

similar manoeuvre is required, it ends at the IF. Standard en-route obstacle clearance criteria should be applied to the arrival segment.

(d) Initial approach segment

The initial approach segment is only required if a course reversal, race track, or arc procedure is necessary to join the intermediate approach track. The segment commences at the IAF and on completion of the manoeuvre ends at the IP. The minimum obstacle clearance (MOC) assigned to the initial approach segment is 1 000 ft.

(e) Intermediate approach segment

The intermediate approach segment commences at the IP, or in the case of straight-in approaches, where there is no initial approach segment, it commences at the IF. The segment ends at the FAP and should not be less than 2 NM in length. The purpose of the intermediate segment is to align and prepare the helicopter for the final approach. During the intermediate segment, the helicopter should be lined up with the final approach track, the speed should be stabilised, the destination should be identified on the radar, and the final approach and missed approach areas should be identified and verified to be clear of radar returns. The MOC assigned to the intermediate segment is 500 ft.

(f) Final approach segment

(1) The final approach segment commences at the FAP and ends at the missed approach point (MAPt). The final approach area, which should be identified on radar, takes the form of a corridor between the FAP and the radar return of the destination. This corridor should not be less than 2 NM wide in order that the projected track of the helicopter does not pass closer than 1 NM to the obstacles lying outside the area.

(2) On passing the FAP, the helicopter will descend below the intermediate approach altitude, and follow a descent gradient which should not be steeper than 6.5 %. At this stage, vertical separation from the offshore obstacle environment will be lost. However, within the final approach area the MDA/H will provide separation from the surface environment. Descent from 1 000 ft AMSL to 200 ft AMSL at a constant 6.5 % gradient will involve a horizontal distance of 2 NM. In order to follow the guideline that the procedure should not generate an unacceptably high workload for the flight crew, the required actions of levelling at MDH, changing heading at the offset initiation point (OIP), and turning away at MAPt should not be planned to occur at the same NM time from the destination.

(3) During the final approach, compensation for drift should be applied and the heading which, if maintained, would take the helicopter directly to the destination, should be identified. It follows that, at an OIP located at a range of 1.5 NM, a heading change of 10° is likely to result in a track offset of 15° at 1 NM, and the extended centreline of the new track can be expected to have a mean position lying some 300 - 400 m to one side of the destination structure. The safety margin built in to the 0.75 NM decision range (DR) is dependent upon the rate of closure with the destination. Although the airspeed should be in the range 60-90 kt during the final approach, the ground speed, after due allowance for wind velocity, should be no greater than 70 kt.

(g) Missed approach segment

(1) The missed approach segment commences at the MAPt and ends when the helicopter reaches minimum en-route altitude. The missed approach manoeuvre is a 'turning missed approach' which should be of not less than 30° and should not, normally, be greater than 45°. A turn away of more than 45° does not reduce the collision risk factor any further, nor will it permit a closer DR. However, turns of more than 45° may increase the risk of pilot

disorientation and, by inhibiting the rate of climb (especially in the case of an OEI missed approach procedure), may keep the helicopter at an extremely low level for longer than is desirable.

- (2) The missed approach area to be used should be identified and verified as a clear area on the radar screen during the intermediate approach segment. The base of the missed approach area is a sloping surface at 2.5 % gradient starting from MDH at the MAPt. The concept is that a helicopter executing a turning missed approach will be protected by the horizontal boundaries of the missed approach area until vertical separation of more than 130 ft is achieved between the base of the area and the offshore obstacle environment of 500 ft AMSL which prevails outside the area.
- (3) A missed approach area, taking the form of a 45° sector orientated left or right of the final approach track, originating from a point 5 NM short of the destination, and terminating on an arc 3 NM beyond the destination, will normally satisfy the specifications of a 30° turning missed approach.

(h) The required visual reference

The visual reference required is that the destination should be in view in order that a safe landing may be carried out.

(i) Radar equipment

During the ARA procedure, colour mapping radar equipment with a 120° sector scan and 2.5 NM range scale selected, may result in dynamic errors of the following order:

- (1) bearing/tracking error $\pm 4.5^\circ$ with 95 % accuracy;
- (2) mean ranging error -250 m; or
- (3) random ranging error ± 250 m with 95 % accuracy.

Figure 1

Arc procedure

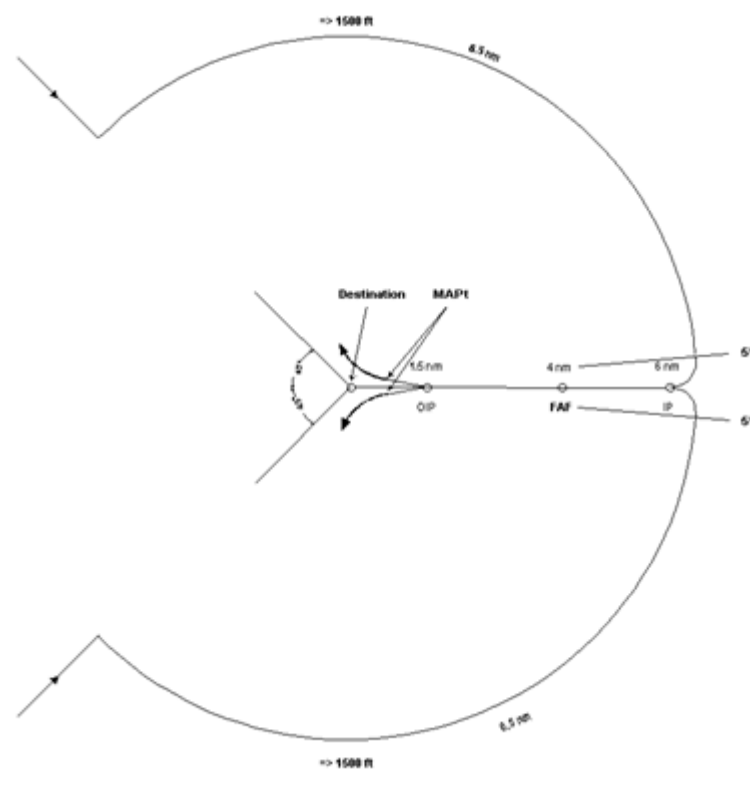

Figure 2

Base turn procedure — direct approach

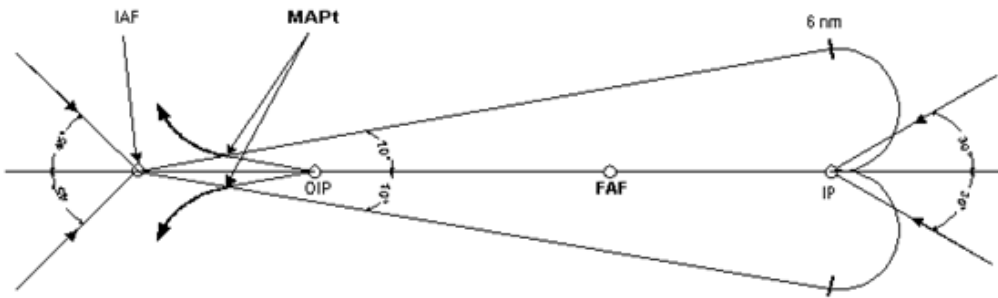

Figure 3

Holding pattern & race track procedure

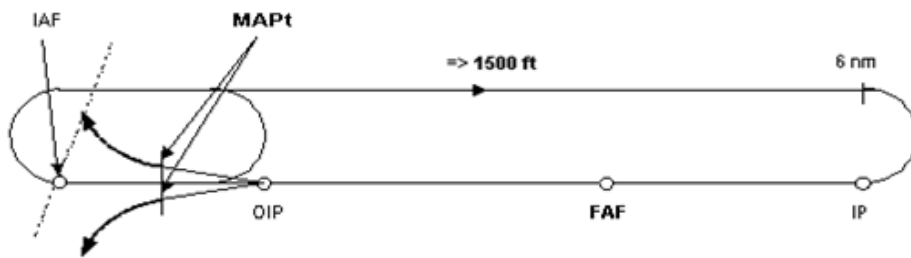

Figure 4

Vertical profile

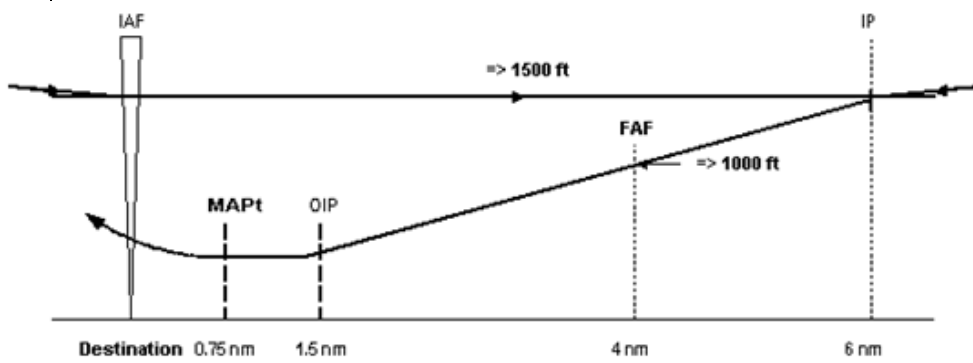
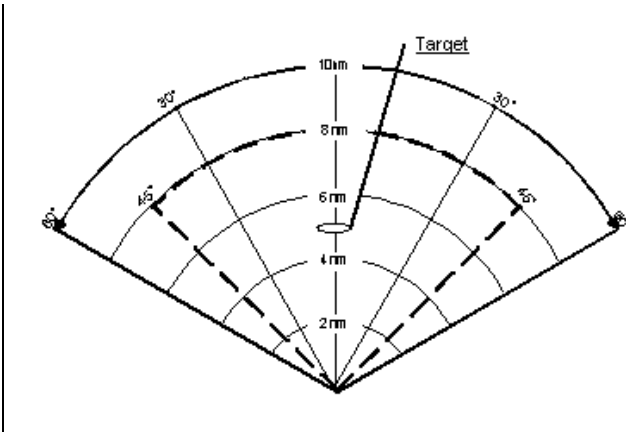

Figure 5

Missed approach area left & right



CAT.OP.MPA.125 Instrument departure and approach procedures

- (a) The operator shall ensure that instrument departure and approach procedures established by the State of the aerodrome are used.
- (b) Notwithstanding (a), the commander may accept an ATC clearance to deviate from a published departure or arrival route, provided obstacle clearance criteria are observed and full account is taken of the operating conditions. In any case, the final approach shall be flown visually or in accordance with the established instrument approach procedures.
- (c) Notwithstanding (a), the operator may use procedures other than those referred to in (a) provided they have been approved by the State in which the aerodrome is located and are specified in the operations manual.

CAT.OP.MPA.126 Performance-based navigation

The operator shall ensure that, when performance-based navigation (PBN) is required for the route or procedure to be flown:

- (a) the relevant PBN navigation specification is stated in the AFM or other document that has been approved by the certifying authority as part of an airworthiness assessment or is based on such approval; and
- (b) the aircraft is operated in conformance with the relevant navigation specification and limitations in the AFM or other document referred above.

AMC1 CAT.OP.MPA.126 Performance-based navigation

PBN OPERATIONS

For operations where a navigation specification for performance-based navigation (PBN) has been prescribed and no specific approval is required in accordance with SPA.PBN.100, the operator should:

- (a) establish operating procedures specifying:
 - (1) normal, abnormal and contingency procedures;
 - (2) electronic navigation database management; and
 - (3) relevant entries in the minimum equipment list (MEL);
- (b) specify the flight crew qualification and proficiency constraints and ensure that the training programme for relevant personnel is consistent with the intended operation; and
- (c) ensure continued airworthiness of the area navigation system.

AMC2 CAT.OP.MPA.126 Performance-based navigation

MONITORING AND VERIFICATION

- (a) Preflight and general considerations
 - (1) At navigation system initialisation, the flight crew should confirm that the navigation database is current and verify that the aircraft position has been entered correctly, if required.
 - (2) The active flight plan, if applicable, should be checked by comparing the charts or other applicable documents with navigation equipment and displays. This includes confirmation of the departing runway and the waypoint sequence, reasonableness of track angles and

distances, any altitude or speed constraints, and, where possible, which waypoints are fly-by and which are fly-over. Where relevant, the RF leg arc radii should be confirmed.

- (3) The flight crew should check that the navigation aids critical to the operation of the intended PBN procedure are available.
 - (4) The flight crew should confirm the navigation aids that should be excluded from the operation, if any.
 - (5) An arrival, approach or departure procedure should not be used if the validity of the procedure in the navigation database has expired.
 - (6) The flight crew should verify that the navigation systems required for the intended operation are operational.
- (b) Departure
- (1) Prior to commencing a take-off on a PBN procedure, the flight crew should check that the indicated aircraft position is consistent with the actual aircraft position at the start of the take-off roll (aeroplanes) or lift-off (helicopters).
 - (2) Where GNSS is used, the signal should be acquired before the take-off roll (aeroplanes) or lift-off (helicopters) commences.
 - (3) Unless automatic updating of the actual departure point is provided, the flight crew should ensure initialisation on the runway or FATO by means of a manual runway threshold or intersection update, as applicable. This is to preclude any inappropriate or inadvertent position shift after take-off.
- (c) Arrival and approach
- (1) The flight crew should verify that the navigation system is operating correctly and the correct arrival procedure and runway (including any applicable transition) are entered and properly depicted.
 - (2) Any published altitude and speed constraints should be observed.
 - (3) The flight crew should check approach procedures (including alternate aerodromes if needed) as extracted by the system (e.g. CDU flight plan page) or presented graphically on the moving map, in order to confirm the correct loading and the reasonableness of the procedure content.
 - (4) Prior to commencing the approach operation (before the IAF), the flight crew should verify the correctness of the loaded procedure by comparison with the appropriate approach charts. This check should include:
 - (i) the waypoint sequence;
 - (ii) reasonableness of the tracks and distances of the approach legs and the accuracy of the inbound course; and
 - (iii) the vertical path angle, if applicable.
- (d) Altimetry settings for RNP APCH operations using Baro VNAV
- (1) Barometric settings
 - (i) The flight crew should set and confirm the correct altimeter setting and check that the two altimeters provide altitude values that do not differ more than 100 ft at the most at or before the final approach fix (FAF).
 - (ii) The flight crew should fly the procedure with:

- (A) a current local altimeter setting source available — a remote or regional altimeter setting source should not be used; and
 - (B) the QNH/QFE, as appropriate, set on the aircraft's altimeters.
- (2) Temperature compensation
- (i) For RNP APCH operations to LNAV/VNAV minima using Baro VNAV:
 - (A) the flight crew should not commence the approach when the aerodrome temperature is outside the promulgated aerodrome temperature limits for the procedure unless the area navigation system is equipped with approved temperature compensation for the final approach;
 - (B) when the temperature is within promulgated limits, the flight crew should not make compensation to the altitude at the FAF and DA/H;
 - (C) since only the final approach segment is protected by the promulgated aerodrome temperature limits, the flight crew should consider the effect of temperature on terrain and obstacle clearance in other phases of flight.
 - (ii) For RNP APCH operations to LNAV minima, the flight crew should consider the effect of temperature on terrain and obstacle clearance in all phases of flight, in particular on any step-down fix.
- (e) Sensor and lateral navigation accuracy selection
- (1) For multi-sensor systems, the flight crew should verify, prior to approach, that the GNSS sensor is used for position computation.
 - (2) Flight crew of aircraft with RNP input selection capability should confirm that the indicated RNP value is appropriate for the PBN operation.

AMC3 CAT.OP.MPA.126 Performance-based navigation

MANAGEMENT OF THE NAVIGATION DATABASE

- (a) For RNAV 1, RNAV 2, RNP 1, RNP 2, and RNP APCH, the flight crew should neither insert nor modify waypoints by manual entry into a procedure (departure, arrival or approach) that has been retrieved from the database. User-defined data may be entered and used for waypoint altitude/speed constraints on a procedure where said constraints are not included in the navigation database coding.
- (b) For RNP 4 operations, the flight crew should not modify waypoints that have been retrieved from the database. User-defined data (e.g. for flex-track routes) may be entered and used.
- (c) The lateral and vertical definition of the flight path between the FAF and the missed approach point (MAPt) retrieved from the database should not be revised by the flight crew.

AMC4 CAT.OP.MPA.126 Performance-based navigation

DISPLAYS AND AUTOMATION

- (a) For RNAV 1, RNP 1, and RNP APCH operations, the flight crew should use a lateral deviation indicator, and where available, flight director and/or autopilot in lateral navigation mode.
- (b) The appropriate displays should be selected so that the following information can be monitored:
 - (1) the computed desired path;

- (2) aircraft position relative to the lateral path (cross-track deviation) for FTE monitoring;
- (3) aircraft position relative to the vertical path (for a 3D operation).
- (c) The flight crew of an aircraft with a lateral deviation indicator (e.g. CDI) should ensure that lateral deviation indicator scaling (full-scale deflection) is suitable for the navigation accuracy associated with the various segments of the procedure.
- (d) The flight crew should maintain procedure centrelines unless authorised to deviate by air traffic control (ATC) or demanded by emergency conditions.
- (e) Cross-track error/deviation (the difference between the area-navigation-system-computed path and the aircraft-computed position) should normally be limited to $\pm \frac{1}{2}$ time the RNAV/RNP value associated with the procedure. Brief deviations from this standard (e.g. overshoots or undershoots during and immediately after turns) up to a maximum of 1 time the RNAV/RNP value should be allowable.
- (f) For a 3D approach operation, the flight crew should use a vertical deviation indicator and, where required by AFM limitations, a flight director or autopilot in vertical navigation mode.
- (g) Deviations below the vertical path should not exceed 75 ft at any time, or half-scale deflection where angular deviation is indicated, and not more than 75 ft above the vertical profile, or half-scale deflection where angular deviation is indicated, at or below 1 000 ft above aerodrome level. The flight crew should execute a missed approach if the vertical deviation exceeds this criterion, unless the flight crew has in sight the visual references required to continue the approach.

AMC5 CAT.OP.MPA.126 Performance-based navigation

VECTORING AND POSITIONING

- (a) ATC tactical interventions in the terminal area may include radar headings, 'direct to' clearances which bypass the initial legs of an approach procedure, interceptions of an initial or intermediate segments of an approach procedure or the insertion of additional waypoints loaded from the database.
- (b) In complying with ATC instructions, the flight crew should be aware of the implications for the navigation system.
- (c) 'Direct to' clearances may be accepted to the IF provided that it is clear to the flight crew that the aircraft will be established on the final approach track at least 2 NM before the FAF.
- (d) 'Direct to' clearance to the FAF should not be acceptable. Modifying the procedure to intercept the final approach track prior to the FAF should be acceptable for radar-vectorred arrivals or otherwise only with ATC approval.
- (e) The final approach trajectory should be intercepted no later than the FAF in order for the aircraft to be correctly established on the final approach track before starting the descent (to ensure terrain and obstacle clearance).
- (f) 'Direct to' clearances to a fix that immediately precede an RF leg should not be permitted.
- (g) For parallel offset operations en route in RNP 4 and A-RNP, transitions to and from the offset track should maintain an intercept angle of no more than 45° unless specified otherwise by ATC.

AMC6 CAT.OP.MPA.126 Performance-based navigation

ALERTING AND ABORT

- (a) Unless the flight crew has sufficient visual reference to continue the approach operation to a safe landing, an RNP APCH operation should be discontinued if:
 - (1) navigation system failure is annunciated (e.g. warning flag);
 - (2) lateral or vertical deviations exceed the tolerances;
 - (3) loss of the on-board monitoring and alerting system.
- (b) Discontinuing the approach operation may not be necessary for a multi-sensor navigation system that includes demonstrated RNP capability without GNSS in accordance with the AFM.
- (c) Where vertical guidance is lost while the aircraft is still above 1 000 ft AGL, the flight crew may decide to continue the approach to LNAV minima, when supported by the navigation system.

AMC7 CAT.OP.MPA.126 Performance-based navigation

CONTINGENCY PROCEDURES

- (a) The flight crew should make the necessary preparation to revert to a conventional arrival procedure where appropriate. The following conditions should be considered:
 - (1) failure of the navigation system components including navigation sensors, and a failure effecting flight technical error (e.g. failures of the flight director or autopilot);
 - (2) multiple system failures affecting aircraft performance;
 - (3) coasting on inertial sensors beyond a specified time limit; and
 - (4) RAIM (or equivalent) alert or loss of integrity function.
- (b) In the event of loss of PBN capability, the flight crew should invoke contingency procedures and navigate using an alternative means of navigation.
- (c) The flight crew should notify ATC of any problem with PBN capability.
- (d) In the event of communication failure, the flight crew should continue with the operation in accordance with published lost communication procedures.

GM1 CAT.OP.MPA.126 Performance-based navigation

DESCRIPTION

- (a) For both, RNP X and RNAV X designations, the 'X' (where stated) refers to the lateral navigation accuracy (total system error) in NM, which is expected to be achieved at least 95 % of the flight time by the population of aircraft operating within the airspace, route or procedure. For RNP APCH and A-RNP, the lateral navigation accuracy depends on the segment.
 - (b) PBN may be required on notified routes, for notified procedures and in notified airspace.
- RNAV 10
- (c) For purposes of consistency with the PBN concept, this Regulation is using the designation 'RNAV 10' because this specification does not include on-board performance monitoring and alerting.

-
- (d) However, it should be noted that many routes still use the designation 'RNP 10' instead of 'RNAV 10'. 'RNP 10' was used as designation before the publication of the fourth edition of ICAO Doc 9613 in 2013. The terms 'RNP 10' and 'RNAV 10' should be considered equivalent.

CAT.OP.MPA.130 Noise abatement procedures — aeroplanes

- (a) Except for VFR operations of other-than complex motor-powered aeroplanes, the operator shall establish appropriate operating departure and arrival/approach procedures for each aeroplane type taking into account the need to minimise the effect of aircraft noise.
- (b) The procedures shall:
 - (1) ensure that safety has priority over noise abatement; and
 - (2) be simple and safe to operate with no significant increase in crew workload during critical phases of flight.

AMC1 CAT.OP.MPA.130 Noise abatement procedures — aeroplanes

NADP DESIGN

- (a) For each aeroplane type, two departure procedures should be defined, in accordance with ICAO Doc 8168 (Procedures for Air Navigation Services, 'PANS-OPS'), Volume I:
 - (1) noise abatement departure procedure one (NADP 1), designed to meet the close-in noise abatement objective; and
 - (2) noise abatement departure procedure two (NADP 2), designed to meet the distant noise abatement objective.
- (b) For each type of NADP (1 and 2), a single climb profile should be specified for use at all aerodromes, which is associated with a single sequence of actions. The NADP 1 and NADP 2 profiles may be identical.

GM1 CAT.OP.MPA.130 Noise abatement procedures — aeroplanes

TERMINOLOGY

- (a) 'Climb profile' means in this context the vertical path of the NADP as it results from the pilot's actions (engine power reduction, acceleration, slats/flaps retraction).
- (b) 'Sequence of actions' means the order in which these pilot's actions are done and their timing.

GENERAL

- (c) The rule addresses only the vertical profile of the departure procedure. Lateral track has to comply with the standard instrument departure (SID).

EXAMPLE

- (d) For a given aeroplane type, when establishing the distant NADP, the operator should choose either to reduce power first and then accelerate, or to accelerate first and then wait until slats/flaps are retracted before reducing power. The two methods constitute two different sequences of actions.
- (e) For an aeroplane type, each of the two departure climb profiles may be defined by one sequence of actions (one for close-in, one for distant) and two above aerodrome level (AAL) altitudes/heights. These are:
 - (1) the altitude of the first pilot's action (generally power reduction with or without acceleration). This altitude should not be less than 800 ft AAL; or

-
- (2) the altitude of the end of the noise abatement procedure. This altitude should usually not be more than 3 000 ft AAL.

These two altitudes may be runway specific when the aeroplane flight management system (FMS) has the relevant function which permits the crew to change thrust reduction and/or acceleration altitude/height. If the aeroplane is not FMS-equipped or the FMS is not fitted with the relevant function, two fixed heights should be defined and used for each of the two NADPs.

CAT.OP.MPA.131 Noise abatement procedures — helicopters

- (a) The operator shall ensure that take-off and landing procedures take into account the need to minimise the effect of helicopter noise.
- (b) The procedures shall:
 - (1) ensure that safety has priority over noise abatement; and
 - (2) be simple and safe to operate with no significant increase in crew workload during critical phases of flight.

CAT.OP.MPA.135 Routes and areas of operation — general

- (a) The operator shall ensure that operations are only conducted along routes, or within areas, for which:
 - (1) space-based facilities, ground facilities and services, including meteorological services, adequate for the planned operation are provided;
 - (2) the performance of the aircraft is adequate to comply with minimum flight altitude requirements;
 - (3) the equipment of the aircraft meets the minimum requirements for the planned operation; and
 - (4) appropriate maps and charts are available.
- (b) The operator shall ensure that operations are conducted in accordance with any restriction on the routes or the areas of operation specified by the competent authority.
- (c) point (a)(1) shall not apply to operations under VFR by day of other-than complex motor-powered aircraft on flights that depart from and arrive at the same aerodrome or operating site.

AMC1 CAT.OP.MPA.135 Routes and areas of operation — general

RNAV 10

- (a) Operating procedures and routes should take account of the RNAV 10 time limit declared for the inertial system, if applicable, considering also the effect of weather conditions that could affect flight duration in RNAV 10 airspace.
- (b) The operator may extend RNAV 10 inertial navigation time by position updating. The operator should calculate, using statistically-based typical wind scenarios for each planned route, points at which updates can be made, and the points at which further updates will not be possible.

CAT.OP.MPA.136 Routes and areas of operation — single-engined aeroplanes

The operator shall ensure that operations of single-engined aeroplanes are only conducted along routes, or within areas, where surfaces are available that permit a safe forced landing to be executed.

CAT.OP.MPA.137 Routes and areas of operation — helicopters

The operator shall ensure that:

- (a) for helicopters operated in performance class 3, surfaces are available that permit a safe forced landing to be executed, except when the helicopter has an approval to operate in accordance with CAT.POL.H.420;

- (b) for helicopters operated in performance class 3 and conducting ‘coastal transit’ operations, the operations manual contains procedures to ensure that the width of the coastal corridor, and the equipment carried, is consistent with the conditions prevailing at the time.

GM1 CAT.OP.MPA.137(b) Routes and areas of operation — helicopters

COASTAL TRANSIT

(a) General

- (1) Helicopters operating overwater in performance class 3 have to have certain equipment fitted. This equipment varies with the distance from land that the helicopter is expected to operate. The aim of this GM is to discuss that distance, bring into focus what fit is required and to clarify the operator's responsibility, when a decision is made to conduct coastal transit operations.
- (2) In the case of operations north of 45N or south of 45S, the coastal corridor facility may or may not be available in a particular state, as it is related to the State definition of open sea area as described in the definition of hostile environment.
- (3) Where the term ‘coastal transit’ is used, it means the conduct of operations overwater within the coastal corridor in conditions where there is reasonable expectation that:
 - (i) the flight can be conducted safely in the conditions prevailing;
 - (ii) following an engine failure, a safe forced landing and successful evacuation can be achieved; and
 - (iii) survival of the crew and passengers can be assured until rescue is effected.
- (4) Coastal corridor is a variable distance from the coastline to a maximum distance corresponding to three minutes’ flying at normal cruising speed.

(b) Establishing the width of the coastal corridor

- (1) The maximum distance from land of coastal transit, is defined as the boundary of a corridor that extends from the land, to a maximum distance of up to 3 minutes at normal cruising speed (approximately 5 - 6 NM). Land in this context includes sustainable ice (see (i) to (iii) below) and, where the coastal region includes islands, the surrounding waters may be included in the corridor and aggregated with the coast and each other. Coastal transit need not be applied to inland waterways, estuary crossing or river transit.
 - (i) In some areas, the formation of ice is such that it can be possible to land, or force land, without hazard to the helicopter or occupants. Unless the competent authority considers that operating to, or over, such ice fields is unacceptable, the operator may regard that the definition of the ‘land’ extends to these areas.
 - (ii) The interpretation of the following rules may be conditional on (i) above:
 - CAT.OP.MPA.137(a)(2);
 - CAT.IDE.H.290;
 - CAT.IDE.H.295;
 - CAT.IDE.H.300; and
 - CAT.IDE.H.320.

- (iii) In view of the fact that such featureless and flat white surfaces could present a hazard and could lead to white-out conditions, the definition of land does not extend to flights over ice fields in the following rules:
 - CAT.IDE.H.125(d); and
 - CAT.IDE.H.145.
- (2) The width of the corridor is variable from not safe to conduct operations in the conditions prevailing, to the maximum of 3 minutes wide. A number of factors will, on the day, indicate if it can be used — and how wide it can be. These factors will include, but not be restricted to, the following:
 - (i) meteorological conditions prevailing in the corridor;
 - (ii) instrument fit of the aircraft;
 - (iii) certification of the aircraft — particularly with regard to floats;
 - (iv) sea state;
 - (v) temperature of the water;
 - (vi) time to rescue; and
 - (vii) survival equipment carried.
- (3) These can be broadly divided into three functional groups:
 - (i) those that meet the provisions for safe flying;
 - (ii) those that meet the provisions for a safe forced landing and evacuation; and
 - (iii) those that meet the provisions for survival following a forced landing and successful evacuation.
- (c) Provision for safe flying
 - (1) It is generally recognised that when flying out of sight of land in certain meteorological conditions, such as those occurring in high pressure weather patterns (goldfish bowl — no horizon, light winds and low visibility), the absence of a basic panel (and training) can lead to disorientation. In addition, lack of depth perception in these conditions demands the use of a radio altimeter with an audio voice warning as an added safety benefit — particularly when autorotation to the surface of the water may be required.
 - (2) In these conditions, the helicopter, without the required instruments and radio altimeter, should be confined to a corridor in which the pilot can maintain reference using the visual cues on the land.
- (d) Provision for a safe forced landing and evacuation
 - (1) Weather and sea state both affect the outcome of an autorotation following an engine failure. It is recognised that the measurement of sea state is problematical and when assessing such conditions, good judgement has to be exercised by the operator and the commander.
 - (2) Where floats have been certificated only for emergency use (and not for ditching), operations should be limited to those sea states that meet the provisions for such use — where a safe evacuation is possible.

Ditching certification requires compliance with a comprehensive number of requirements relating to rotorcraft water entry, flotation and trim, occupant egress and occupant survival. Emergency flotation systems, generally fitted to smaller CS-27 rotorcraft, are approved

against a broad specification that the equipment should perform its intended function and not hazard the rotorcraft or its occupants. In practice, the most significant difference between ditching and emergency flotation systems is substantiation of the water entry phase. Ditching rules call for water entry procedures and techniques to be established and promulgated in the AFM. The fuselage/flotation equipment should thereafter be shown to be able to withstand loads under defined water entry conditions which relate to these procedures. For emergency flotation equipment, there is no specification to define the water entry technique and no specific conditions defined for the structural substantiation.

(e) Provisions for survival

- (1) Survival of crew members and passengers, following a successful autorotation and evacuation, is dependent on the clothing worn, the equipment carried and worn, the temperature of the sea and the sea state. Search and rescue (SAR) response/capability consistent with the anticipated exposure should be available before the conditions in the corridor can be considered non-hostile.
- (2) Coastal transit can be conducted (including north of 45N and south of 45S — when the definition of open sea areas allows) providing the provisions of (c) and (d) are met, and the conditions for a non-hostile coastal corridor are satisfied.

CAT.OP.MPA.140 Maximum distance from an adequate aerodrome for two-engined aeroplanes without an ETOPS approval

- (a) Unless approved by the competent authority in accordance with Annex V (Part-SPA), Subpart F, the operator shall not operate a two-engined aeroplane over a route that contains a point further from an adequate aerodrome, under standard conditions in still air, than:
- (1) for performance class A aeroplanes with either:
 - (i) a maximum operational passenger seating configuration (MOPSC) of 20 or more; or
 - (ii) a maximum take-off mass of 45 360 kg or more,the distance flown in 60 minutes at the one-engine-inoperative (OEI) cruising speed determined in accordance with (b);
 - (2) for performance class A aeroplanes with:
 - (i) an MOPSC of 19 or less; and
 - (ii) a maximum take-off mass less than 45 360 kg,the distance flown in 120 minutes or, subject to approval by the competent authority, up to 180 minutes for turbo-jet aeroplanes, at the OEI cruise speed determined in accordance with (b);
 - (3) for performance class B or C aeroplanes:
 - (i) the distance flown in 120 minutes at the OEI cruise speed determined in accordance with (b); or
 - (ii) 300 NM, whichever is less.
- (b) The operator shall determine a speed for the calculation of the maximum distance to an adequate aerodrome for each two-engined aeroplane type or variant operated, not exceeding V_{MO} (maximum operating speed) based upon the true airspeed that the aeroplane can maintain with one engine inoperative.
- (c) The operator shall include the following data, specific to each type or variant, in the operations manual:
- (1) the determined OEI cruising speed; and
 - (2) the determined maximum distance from an adequate aerodrome.
- (d) To obtain the approval referred to in (a)(2), the operator shall provide evidence that:
- (1) the aeroplane/engine combination holds an extended range operations with two-engined aeroplanes (ETOPS) type design and reliability approval for the intended operation;
 - (2) a set of conditions has been implemented to ensure that the aeroplane and its engines are maintained to meet the necessary reliability criteria; and
 - (3) the flight crew and all other operations personnel involved are trained and suitably qualified to conduct the intended operation.

AMC1 CAT.OP.MPA.140(d) Maximum distance from an adequate aerodrome for two-engined aeroplanes without an ETOPS approval

OPERATION OF NON-ETOPS COMPLIANT TWIN TURBO-JET AEROPLANES WITH MOPSC OF 19 OR LESS AND MCTOM LESS THAN 45 360 KG BETWEEN 120 AND 180 MINUTES FROM AN ADEQUATE AERODROME

(a) For operations between 120 and 180 minutes, due account should be taken of the aeroplane's design and capabilities as outlined below and the operator's experience related to such operations. Relevant information should be included in the operations manual and the operator's maintenance procedures. The term 'the aeroplane's design' in this AMC does not imply any additional type design approval specifications beyond the applicable original type certificate (TC) specifications.

(b) Systems capability

Aeroplanes should be certified to CS-25 as appropriate or equivalent (e.g. FAR-25). With respect to the capability of the aeroplane systems, the objective is that the aeroplane is capable of a safe diversion from the maximum diversion distance with particular emphasis on operations with OEI or with degraded system capability. To this end, the operator should give consideration to the capability of the following systems to support such a diversion:

- (1) Propulsion systems: the aeroplane engine should meet the applicable specifications prescribed in CS-25 and CS-E or equivalent (e.g. FAR-25, FAR-E), concerning engine TC, installation and system operation. In addition to the performance standards established by the Agency or competent authority at the time of engine certification, the engines should comply with all subsequent mandatory safety standards specified by the Agency or competent authority, including those necessary to maintain an acceptable level of reliability. In addition, consideration should be given to the effects of extended duration single-engine operation (e.g. the effects of higher power demands such as bleed and electrical).
- (2) Airframe systems: with respect to electrical power, three or more reliable as defined by CS-25 or equivalent (e.g. FAR-25) and independent electrical power sources should be available, each of which should be capable of providing power for all essential services which should at least include the following:
 - (i) sufficient instruments for the flight crew providing, as a minimum, attitude, heading, airspeed and altitude information;
 - (ii) appropriate pitot heating;
 - (iii) adequate navigation capability;
 - (iv) adequate radio communication and intercommunication capability;
 - (v) adequate flight deck and instrument lighting and emergency lighting;
 - (vi) adequate flight controls;
 - (vii) adequate engine controls and restart capability with critical type fuel (from the stand-point of flame-out and restart capability) and with the aeroplane initially at the maximum relight altitude;
 - (viii) adequate engine instrumentation;
 - (ix) adequate fuel supply system capability including such fuel boost and fuel transfer functions that may be necessary for extended duration single or dual-engine operation;

- (x) such warnings, cautions and indications as are required for continued safe flight and landing;
- (xi) fire protection (engines and auxiliary power unit (APU));
- (xii) adequate ice protection including windshield de-icing; and
- (xiii) adequate control of the flight crew compartment and cabin environment including heating and pressurisation.

The equipment including avionics necessary for extended diversion times should have the ability to operate acceptably following failures in the cooling system or electrical power systems.

For single-engine operations, the remaining power electrical, hydraulic, and pneumatic should continue to be available at levels necessary to permit continued safe flight and landing, and to provide those services necessary for the overall safety of the passengers and crew. As a minimum, following the failure of any two of the three electrical power sources, the remaining source should be capable of providing power for all of the items necessary for the duration of any diversion. If one or more of the required electrical power sources are provided by an APU, hydraulic system or air driven generator/ram air turbine (ADG/RAT), the following criteria should apply as appropriate:

- (i) to ensure hydraulic power (hydraulic motor generator) reliability, it may be necessary to provide two or more independent energy sources;
 - (ii) the ADG/RAT, if fitted, should not require engine dependent power for deployment; and
 - (iii) the APU should meet the criteria in (b)(3).
- (3) APU: the APU, if required for extended range operations, should be certified as an essential APU and should meet the applicable CS-25 and CS-APU provisions or equivalent (e.g. FAR-25).
- (4) Fuel supply system: consideration should include the capability of the fuel supply system to provide sufficient fuel for the entire diversion taking account of aspects such as fuel boost and fuel transfer.
- (c) Engine events and corrective action
- (1) All engine events and operating hours should be reported by the operator to the airframe and engine supplemental type certificate (STC) holders as well as to the competent authority.
 - (2) These events should be evaluated by the operator in consultation with the competent authority and with the engine and airframe (S)TC holders. The competent authority may consult the Agency to ensure that worldwide data are evaluated.
 - (3) Where statistical assessment alone is not applicable, e.g. where the fleet size or accumulated flight hours are small, individual engine events should be reviewed on a case-by-case basis.
 - (4) The evaluation or statistical assessment, when available, may result in corrective action or the application of operational restrictions.
 - (5) Engine events could include engine shutdowns, both on ground and in-flight, excluding normal training events, including flameout, occurrences where the intended thrust level was not achieved or where crew action was taken to reduce thrust below the normal level for whatever reason, and unscheduled removals.

- (6) Arrangements to ensure that all corrective actions required by the Agency are implemented.

(d) Maintenance

The maintenance programme in accordance with Annex I to Commission Regulation (EC) No 2042/2003⁷ (Part-M) should be based upon reliability programmes including, but not limited to, the following elements:

- (1) engine oil consumption programmes: such programmes are intended to support engine condition trend monitoring; and
- (2) engine condition monitoring programme: a programme for each engine that monitors engine performance parameters and trends of degradation that provides for maintenance actions to be undertaken prior to significant performance loss or mechanical failure.

(e) Flight crew training

Flight crew training for this type of operation should include, in addition to the requirements of Subpart FC of Annex III (ORO.FC), particular emphasis on the following:

- (1) Fuel management: verifying required fuel on board prior to departure and monitoring fuel on board en-route including calculation of fuel remaining. Procedures should provide for an independent cross-check of fuel quantity indicators, e.g. fuel flow used to calculate fuel burned compared to indicate fuel remaining. Confirmation that the fuel remaining is sufficient to satisfy the critical fuel reserves.
- (2) Procedures for single and multiple failures in-flight that may give rise to go/no-go and diversion decisions — policy and guidelines to aid the flight crew in the diversion decision making process and the need for constant awareness of the closest weather-permissible alternate aerodrome in terms of time.
- (3) OEI performance data: drift down procedures and OEI service ceiling data.
- (4) Weather reports and flight requirements: meteorological aerodrome reports (METARs) and aerodrome forecast (TAF) reports and obtaining in-flight weather updates on the en-route alternate (ERA), destination and destination alternate aerodromes. Consideration should also be given to forecast winds including the accuracy of the forecast compared to actual wind experienced during flight and meteorological conditions along the expected flight path at the OEI cruising altitude and throughout the approach and landing.

(f) Pre-departure check

A pre-departure check, additional to the pre-flight inspection required by Part-M should be reflected in the operations manual. Flight crew members who are responsible for the pre-departure check of an aeroplane should be fully trained and competent to do it. The training programme required should cover all relevant tasks with particular emphasis on checking required fluid levels.

(g) MEL

The MEL should take into account all items specified by the manufacturer relevant to operations in accordance with this AMC.

⁷ Commission Regulation (EC) No 2042/2003 of 20 November 2003 on the continuing airworthiness of aircraft and aeronautical products, parts and appliances, and on the approval of organisations and personnel involved in these tasks (OJ L 315, 28.11.2003, p. 1).

(h) Dispatch/flight planning rules

The operator's dispatch rules should address the following:

- (1) Fuel and oil supply: an aeroplane should not be dispatched on an extended range flight unless it carries sufficient fuel and oil to comply with the applicable operational requirements and any additional reserves determined in accordance with the following:
 - (i) Critical fuel scenario — the critical point is the furthest point from an alternate aerodrome assuming a simultaneous failure of an engine and the pressurisation system. For those aeroplanes that are type certificated to operate above flight level 450, the critical point is the furthest point from an alternate aerodrome assuming an engine failure. The operator should carry additional fuel for the worst case fuel burn condition (one engine vs two engines operating) if this is greater than the additional fuel calculated in accordance with the fuel requirements in CAT.OP.MPA, as follows:
 - (A) fly from the critical point to an alternate aerodrome:
 - (a) at 10 000 ft;
 - (b) at 25 000 ft or the single-engine ceiling, whichever is lower, provided that all occupants can be supplied with and use oxygen for the time required to fly from the critical point to an alternate aerodrome; or
 - (c) at the single-engine ceiling, provided that the aeroplane is type certified to operate above flight level 450;
 - (B) descend and hold at 1 500 ft for 15 minutes in international standard atmosphere (ISA) conditions;
 - (C) descend to the applicable MDA/DH followed by a missed approach (taking into account the complete missed approach procedure); followed by
 - (D) a normal approach and landing.
 - (ii) Ice protection: additional fuel used when operating in icing conditions (e.g. operation of ice protection systems (engine/airframe as applicable)) and, when manufacturer's data are available, take account of ice accumulation on unprotected surfaces if icing conditions are likely to be encountered during a diversion.
 - (iii) APU operation: if an APU has to be used to provide additional electrical power, consideration should be given to the additional fuel required.
- (2) Communication facilities: the availability of communications facilities in order to allow reliable two-way voice communications between the aeroplane and the appropriate ATC unit at OEI cruise altitudes.
- (3) Aircraft technical log review to ensure proper MEL procedures, deferred items, and required maintenance checks completed.
- (4) ERA aerodrome(s): ensuring that ERA aerodromes are available for the intended route, within the distance flown in 180 minutes based upon the OEI cruising speed which is a speed within the certificated limits of the aeroplane, selected by the operator and approved by the competent authority, confirming that, based on the available meteorological information, the weather conditions at ERA aerodromes are at or above the applicable minima for the period of time during which the aerodrome(s) may be used.

Table 1

Planning minima

Approach facility	Alternate aerodrome ceiling	Weather minima RVR/VIS
PA	DA/H +200 ft	RVR/VIS +800 m
NPA Circling approach	MDA/H +400 ft	RVR/VIS +1 500 m

GM1 CAT.OP.MPA.140(c) Maximum distance from an adequate aerodrome for two-engined aeroplanes without an ETOPS approval**ONE-ENGINE-INOPERATIVE (OEI) CRUISING SPEED**

The OEI cruising speed is intended to be used solely for establishing the maximum distance from an adequate aerodrome.

CAT.OP.MPA.145 Establishment of minimum flight altitudes

- (a) The operator shall establish for all route segments to be flown:
 - (1) minimum flight altitudes that provide the required terrain clearance, taking into account the requirements of Subpart C; and
 - (2) a method for the flight crew to determine those altitudes.
- (b) The method for establishing minimum flight altitudes shall be approved by the competent authority.
- (c) Where the minimum flight altitudes established by the operator and a State overflown differ, the higher values shall apply.

AMC1 CAT.OP.MPA.145(a) Establishment of minimum flight altitudes

CONSIDERATIONS FOR ESTABLISHING MINIMUM FLIGHT ALTITUDES

- (a) The operator should take into account the following factors when establishing minimum flight altitudes:
 - (1) the accuracy with which the position of the aircraft can be determined;
 - (2) the probable inaccuracies in the indications of the altimeters used;
 - (3) the characteristics of the terrain, such as sudden changes in the elevation, along the routes or in the areas where operations are to be conducted;
 - (4) the probability of encountering unfavourable meteorological conditions, such as severe turbulence and descending air currents; and
 - (5) possible inaccuracies in aeronautical charts.
- (b) The operator should also consider:
 - (1) corrections for temperature and pressure variations from standard values;
 - (2) ATC requirements; and
 - (3) any foreseeable contingencies along the planned route.

AMC1.1 CAT.OP.MPA.145(a) Establishment of minimum flight altitudes

CONSIDERATIONS FOR ESTABLISHING MINIMUM FLIGHT ALTITUDES

This AMC provides another means of complying with the rule for VFR operations of other-than-complex motor-powered aircraft by day, compared to that presented in AMC1 CAT.OP.MPA.145(a). The safety objective should be satisfied if the operator ensures that operations are only conducted along such routes or within such areas for which a safe terrain clearance can be maintained and take account of such factors as temperature, terrain and unfavourable meteorological conditions.

GM1 CAT.OP.MPA.145(a) Establishment of minimum flight altitudes

MINIMUM FLIGHT ALTITUDES

- (a) The following are examples of some of the methods available for calculating minimum flight altitudes.
- (b) KSS formula:

- (1) Minimum obstacle clearance altitude (MOCA)
 - (i) MOCA is the sum of:
 - (A) the maximum terrain or obstacle elevation, whichever is higher; plus
 - (B) 1 000 ft for elevation up to and including 6 000 ft; or
 - (C) 2 000 ft for elevation exceeding 6 000 ft rounded up to the next 100 ft.
 - (ii) The lowest MOCA to be indicated is 2 000 ft.
 - (iii) From a VOR station, the corridor width is defined as a borderline starting 5 NM either side of the VOR, diverging 4° from centreline until a width of 20 NM is reached at 70 NM out, thence paralleling the centreline until 140 NM out, thence again diverging 4° until a maximum width of 40 NM is reached at 280 NM out. Thereafter, the width remains constant (see Figure 1).

Figure 1

Corridor width from a VOR station

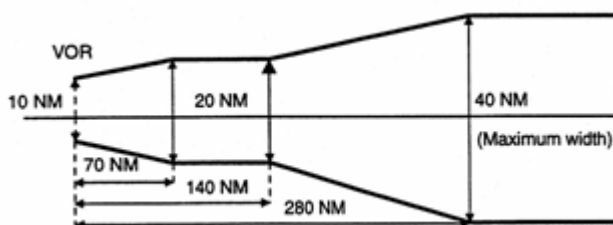

- (iv) From a non-directional beacon (NDB), similarly, the corridor width is defined as a borderline starting 5 NM either side of the NDB diverging 7° until a width of 20 NM is reached 40 NM out, thence paralleling the centreline until 80 NM out, thence again diverging 7° until a maximum width of 60 NM is reached 245 NM out. Thereafter, the width remains constant (see Figure 2).

Figure 2

Corridor width from an NDB

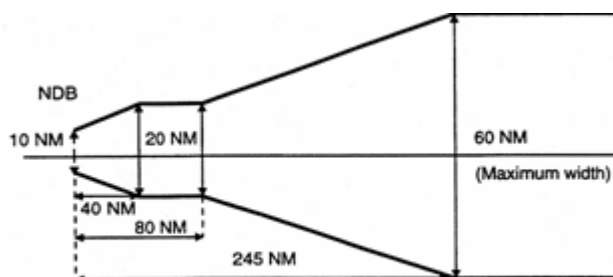

- (v) MOCA does not cover any overlapping of the corridor.
- (2) Minimum off-route altitude (MORA). MORA is calculated for an area bounded by each or every second LAT/LONG square on the route facility chart (RFC)/terminal approach chart (TAC) and is based on a terrain clearance as follows:
 - (i) terrain with elevation up to 6 000 ft (2 000 m) – 1 000 ft above the highest terrain and obstructions;

- (ii) terrain with elevation above 6 000 ft (2 000 m) – 2 000 ft above the highest terrain and obstructions.
- (c) Jeppesen formula (see Figure 3)
- (1) MORA is a minimum flight altitude computed by Jeppesen from current operational navigation charts (ONCs) or world aeronautical charts (WACs). Two types of MORAs are charted which are:
 - (i) route MORAs e.g. 9800a; and
 - (ii) grid MORAs e.g. 98.
 - (2) Route MORA values are computed on the basis of an area extending 10 NM to either side of route centreline and including a 10 NM radius beyond the radio fix/reporting point or mileage break defining the route segment.
 - (3) MORA values clear all terrain and man-made obstacles by 1 000 ft in areas where the highest terrain elevation or obstacles are up to 5 000 ft. A clearance of 2 000 ft is provided above all terrain or obstacles that are 5 001 ft and above.
 - (4) A grid MORA is an altitude computed by Jeppesen and the values are shown within each grid formed by charted lines of latitude and longitude. Figures are shown in thousands and hundreds of feet (omitting the last two digits so as to avoid chart congestion). Values followed by ± are believed not to exceed the altitudes shown. The same clearance criteria as explained in (c)(3) apply.

Figure 3

Jeppesen formula

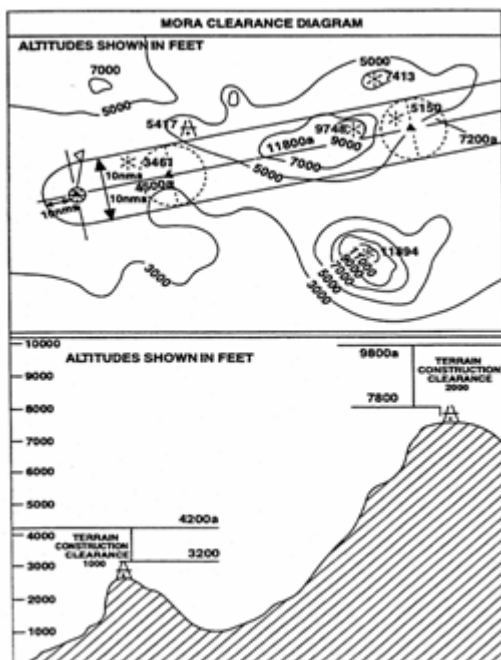

- (d) ATLAS formula
- (1) Minimum en-route altitude (MEA). Calculation of the MEA is based on the elevation of the highest point along the route segment concerned (extending from navigational aid to navigational aid) within a distance on either side of track as specified in Table 1 below:

Table 1

Minimum safe en-route altitude

Segment length	Distance either side of track
Up to 100 NM	10 NM *
More than 100 NM	10 % of segment length up to a maximum of 60 NM **

*: This distance may be reduced to 5 NM within terminal control areas (TMAs) where, due to the number and type of available navigational aids, a high degree of navigational accuracy is warranted.

** : In exceptional cases, where this calculation results in an operationally impracticable value, an additional special MEA may be calculated based on a distance of not less than 10 NM either side of track. Such special MEA will be shown together with an indication of the actual width of protected airspace.

- (2) The MEA is calculated by adding an increment to the elevation specified above as appropriate, following Table 2 below. The resulting value is adjusted to the nearest 100 ft.

Table 2:

Increment added to the elevation *

Elevation of highest point	Increment
Not above 5 000 ft	1 500 ft
Above 5 000 ft but not above 10 000 ft	2 000 ft
Above 10 000 ft	10 % of elevation plus 1 000 ft

*: For the last route segment ending over the initial approach fix, a reduction to 1 000 ft is permissible within TMAs where, due to the number and type of available navigation aids, a high degree of navigational accuracy is warranted.

- (3) Minimum safe grid altitude (MGA). Calculation of the MGA is based on the elevation of the highest point within the respective grid area.

The MGA is calculated by adding an increment to the elevation specified above as appropriate, following Table 3 below. The resulting value is adjusted to the nearest 100 ft.

Table 3

Minimum safe grid altitude

Elevation of highest point	Increment
Not above 5 000 ft	1 500 ft
Above 5 000 ft but not above 10 000 ft	2 000 ft
Above 10 000 ft	10 % of elevation plus 1 000 ft

(e) Lido formula

(1) Minimum terrain clearance altitude (MTCA)

The MTCA represents an altitude providing terrain and obstacle clearance for all airways/ATS routes, all standard terminal arrival route (STAR) segments up to IAF or equivalent end point and for selected standard instrument departures (SIDs).

The MTCA is calculated by Lido and covers terrain and obstacle clearance relevant for air navigation with the following buffers:

(i) Horizontal:

- (A) for SID and STAR procedures 5 NM either side of centre line; and
- (B) for airways/ATS routes 10 NM either side of centre line.

(ii) Vertical:

- (A) 1 000 ft up to 6 000 ft; and
- (B) 2 000 ft above 6 000 ft.

MTCA is always shown in feet. The lowest indicated MTCA is 3 100 ft.

(2) Minimum grid altitude (MGA)

MGA represents the lowest safe altitude which can be flown off-track. The MGA is calculated by rounding up the elevation of the highest obstruction within the respective grid area to the next 100 ft and adding an increment of

- (i) 1 000 ft for terrain or obstructions up to 6 000 ft; and
- (ii) 2 000 ft for terrain or obstructions above 6 000 ft.

MGA is shown in hundreds of feet. The lowest indicated MGA is 2 000 ft. This value is also provided for terrain and obstacles that would result in an MGA below 2 000 ft. An exception is over water areas where the MGA can be omitted.

CAT.OP.MPA.150 Fuel policy

- (a) The operator shall establish a fuel policy for the purpose of flight planning and in-flight replanning to ensure that every flight carries sufficient fuel for the planned operation and reserves to cover deviations from the planned operation. The fuel policy and any change to it require prior approval by the competent authority.
- (b) The operator shall ensure that the planning of flights is based upon at least:
- (1) procedures contained in the operations manual and:
 - (i) data provided by the aircraft manufacturer; or
 - (ii) current aircraft-specific data derived from a fuel consumption monitoring system;and
 - (2) the operating conditions under which the flight is to be conducted including:
 - (i) aircraft fuel consumption data;
 - (ii) anticipated masses;
 - (iii) expected meteorological conditions; and
 - (iv) air navigation services provider(s) procedures and restrictions.
- (c) The operator shall ensure that the pre-flight calculation of usable fuel required for a flight includes:
- (1) taxi fuel;
 - (2) trip fuel;
 - (3) reserve fuel consisting of:
 - (i) contingency fuel;
 - (ii) alternate fuel, if a destination alternate aerodrome is required;
 - (iii) final reserve fuel; and
 - (iv) additional fuel, if required by the type of operation;and
 - (4) extra fuel if required by the commander.
- (d) The operator shall ensure that in-flight replanning procedures for calculating usable fuel required when a flight has to proceed along a route or to a destination aerodrome other than originally planned includes:
- (1) trip fuel for the remainder of the flight; and
 - (2) reserve fuel consisting of:
 - (i) contingency fuel;
 - (ii) alternate fuel, if a destination alternate aerodrome is required;
 - (iii) final reserve fuel; and
 - (iv) additional fuel, if required by the type of operation;and
 - (3) extra fuel if required by the commander.

AMC1 CAT.OP.MPA.150(b) Fuel policy

PLANNING CRITERIA — AEROPLANES

The operator should base the defined fuel policy, including calculation of the amount of fuel to be on board for departure, on the following planning criteria:

(a) Basic procedure

The usable fuel to be on board for departure should be the sum of the following:

- (1) Taxi fuel, which should not be less than the amount expected to be used prior to take-off. Local conditions at the departure aerodrome and auxiliary power unit (APU) consumption should be taken into account.
- (2) Trip fuel, which should include:
 - (i) fuel for take-off and climb from aerodrome elevation to initial cruising level/altitude, taking into account the expected departure routing;
 - (ii) fuel from top of climb to top of descent, including any step climb/descent;
 - (iii) fuel from top of descent to the point where the approach is initiated, taking into account the expected arrival procedure; and
 - (iv) fuel for approach and landing at the destination aerodrome.
- (3) Contingency fuel, except as provided for in (b), which should be the higher of:
 - (i) Either:
 - (A) 5 % of the planned trip fuel or, in the event of in-flight replanning, 5 % of the trip fuel for the remainder of the flight;
 - (B) not less than 3 % of the planned trip fuel or, in the event of in-flight replanning, 3 % of the trip fuel for the remainder of the flight, provided that an en-route alternate (ERA) aerodrome is available;
 - (C) an amount of fuel sufficient for 20 minutes flying time based upon the planned trip fuel consumption, provided that the operator has established a fuel consumption monitoring programme for individual aeroplanes and uses valid data determined by means of such a programme for fuel calculation; or
 - (D) an amount of fuel based on a statistical method that ensures an appropriate statistical coverage of the deviation from the planned to the actual trip fuel. This method is used to monitor the fuel consumption on each city pair/aeroplane combination and the operator uses this data for a statistical analysis to calculate contingency fuel for that city pair/aeroplane combination;
 - (ii) or an amount to fly for 5 minutes at holding speed at 1 500 ft (450 m), above the destination aerodrome in standard conditions.
- (4) Alternate fuel, which should:
 - (i) include:
 - (A) fuel for a missed approach from the applicable DA/H or MDA/H at the destination aerodrome to missed approach altitude, taking into account the complete missed approach procedure;
 - (B) fuel for climb from missed approach altitude to cruising level/altitude, taking into account the expected departure routing;

- (C) fuel for cruise from top of climb to top of descent, taking into account the expected routing;
 - (D) fuel for descent from top of descent to the point where the approach is initiated, taking into account the expected arrival procedure; and
 - (E) fuel for executing an approach and landing at the destination alternate aerodrome;
- (ii) where two destination alternate aerodromes are required, be sufficient to proceed to the alternate aerodrome that requires the greater amount of alternate fuel.
- (5) Final reserve fuel, which should be:
- (i) for aeroplanes with reciprocating engines, fuel to fly for 45 minutes; or
 - (ii) for aeroplanes with turbine engines, fuel to fly for 30 minutes at holding speed at 1 500 ft (450 m) above aerodrome elevation in standard conditions, calculated with the estimated mass on arrival at the destination alternate aerodrome or the destination aerodrome, when no destination alternate aerodrome is required.
- (6) The minimum additional fuel, which should permit:
- (i) the aeroplane to descend as necessary and proceed to an adequate alternate aerodrome in the event of engine failure or loss of pressurisation, whichever requires the greater amount of fuel based on the assumption that such a failure occurs at the most critical point along the route, and
 - (A) hold there for 15 minutes at 1 500 ft (450 m) above aerodrome elevation in standard conditions; and
 - (B) make an approach and landing,
except that additional fuel is only required if the minimum amount of fuel calculated in accordance with (a)(2) to (a)(5) is not sufficient for such an event; and
 - (ii) holding for 15 minutes at 1 500 ft (450 m) above destination aerodrome elevation in standard conditions, when a flight is operated without a destination alternate aerodrome.
- (7) Extra fuel, which should be at the discretion of the commander.
- (b) Reduced contingency fuel (RCF) procedure
- If the operator's fuel policy includes pre-flight planning to a destination 1 aerodrome (commercial destination) with an RCF procedure using a decision point along the route and a destination 2 aerodrome (optional refuel destination), the amount of usable fuel, on board for departure, should be the greater of (b)(1) or (b)(2):
- (1) The sum of:
- (i) taxi fuel;
 - (ii) trip fuel to the destination 1 aerodrome, via the decision point;
 - (iii) contingency fuel equal to not less than 5 % of the estimated fuel consumption from the decision point to the destination 1 aerodrome;
 - (iv) alternate fuel or no alternate fuel if the decision point is at less than 6 hours from the destination 1 aerodrome and the requirements of CAT.OP.MPA.180(b)(2), are fulfilled;

- (v) final reserve fuel;
 - (vi) additional fuel; and
 - (vii) extra fuel if required by the commander.
- (2) The sum of:
- (i) taxi fuel;
 - (ii) trip fuel to the destination 2 aerodrome, via the decision point;
 - (iii) contingency fuel equal to not less than the amount calculated in accordance with (a)(3) above from departure aerodrome to the destination 2 aerodrome;
 - (iv) alternate fuel, if a destination 2 alternate aerodrome is required;
 - (v) final reserve fuel;
 - (vi) additional fuel; and
 - (vii) extra fuel if required by the commander.
- (c) Predetermined point (PDP) procedure
- If the operator's fuel policy includes planning to a destination alternate aerodrome where the distance between the destination aerodrome and the destination alternate aerodrome is such that a flight can only be routed via a predetermined point to one of these aerodromes, the amount of usable fuel, on board for departure, should be the greater of (c)(1) or (c)(2):
- (1) The sum of:
- (i) taxi fuel;
 - (ii) trip fuel from the departure aerodrome to the destination aerodrome, via the predetermined point;
 - (iii) contingency fuel calculated in accordance with (a)(3);
 - (iv) additional fuel if required, but not less than:
 - (A) for aeroplanes with reciprocating engines, fuel to fly for 45 minutes plus 15 % of the flight time planned to be spent at cruising level or 2 hours, whichever is less; or
 - (B) for aeroplanes with turbine engines, fuel to fly for 2 hours at normal cruise consumption above the destination aerodrome,this should not be less than final reserve fuel; and
 - (v) extra fuel if required by the commander.
- (2) The sum of:
- (i) taxi fuel;
 - (ii) trip fuel from the departure aerodrome to the destination alternate aerodrome, via the predetermined point;
 - (iii) contingency fuel calculated in accordance with (a)(3);
 - (iv) additional fuel if required, but not less than:
 - (A) for aeroplanes with reciprocating engines: fuel to fly for 45 minutes; or

(B) for aeroplanes with turbine engines: fuel to fly for 30 minutes at holding speed at 1 500 ft (450 m) above the destination alternate aerodrome elevation in standard conditions,

this should not be less than final reserve fuel; and

(v) extra fuel if required by the commander.

(d) Isolated aerodrome procedure

If the operator's fuel policy includes planning to an isolated aerodrome, the last possible point of diversion to any available en-route alternate (ERA) aerodrome should be used as the predetermined point.

AMC2 CAT.OP.MPA.150(b) Fuel policy

LOCATION OF THE FUEL EN-ROUTE ALTERNATE (FUEL ERA) AERODROME

(a) The fuel ERA aerodrome should be located within a circle having a radius equal to 20 % of the total flight plan distance, the centre of which lies on the planned route at a distance from the destination aerodrome of 25 % of the total flight plan distance, or at least 20 % of the total flight plan distance plus 50 NM, whichever is greater. All distances should be calculated in still air conditions (see Figure 1).

Figure 1

Location of the fuel ERA aerodrome for the purposes of reducing contingency fuel to 3 %

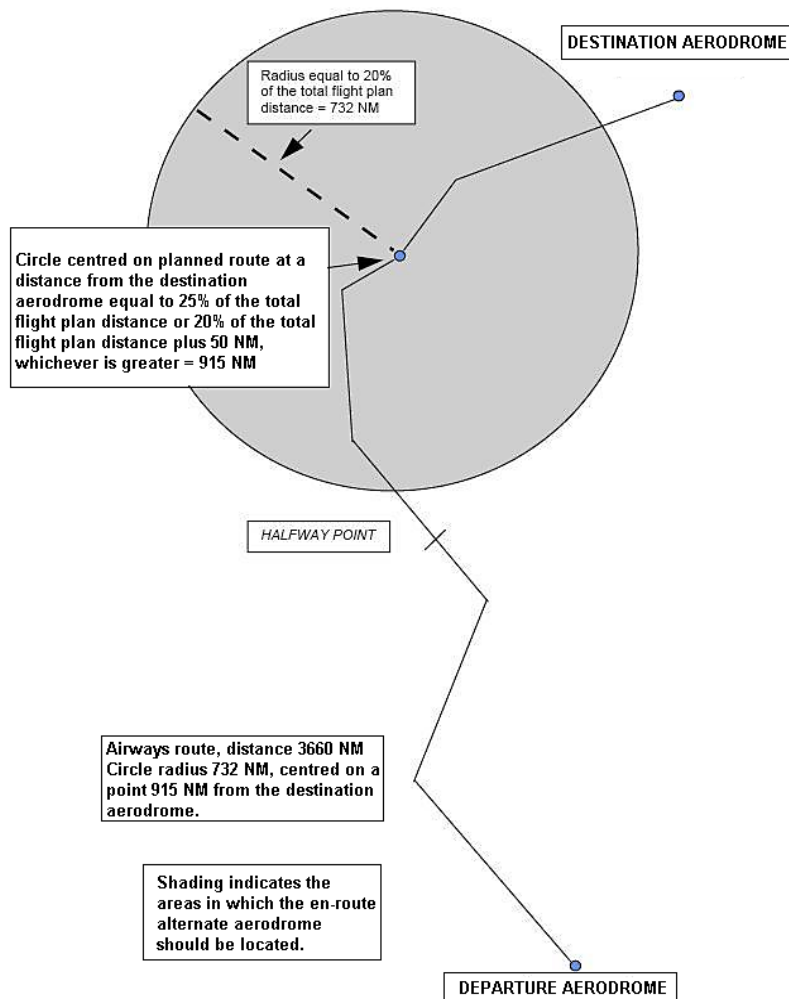

AMC3 CAT.OP.MPA.150(b) Fuel policy

PLANNING CRITERIA — HELICOPTERS

The operator should base the company fuel policy, including calculation of the amount of fuel to be carried, on the following planning criteria:

- (a) The amount of:
 - (1) taxi fuel, which should not be less than the amount expected to be used prior to take-off. Local conditions at the departure site and APU consumption should be taken into account;
 - (2) trip fuel, which should include fuel:
 - (i) for take-off and climb from aerodrome elevation to initial cruising level/altitude, taking into account the expected departure routing;
 - (ii) from top of climb to top of descent, including any step climb/descent;
 - (iii) from top of descent to the point where the approach procedure is initiated, taking into account the expected arrival procedure; and
 - (iv) for approach and landing at the destination site;
 - (3) contingency fuel, which should be:

- (i) for IFR flights, or for VFR flights in a hostile environment, 10 % of the planned trip fuel; or
 - (ii) for VFR flights in a non-hostile environment, 5 % of the planned trip fuel;
- (4) alternate fuel, which should be:
- (i) fuel for a missed approach from the applicable MDA/DH at the destination aerodrome to missed approach altitude, taking into account the complete missed approach procedure;
 - (ii) fuel for a climb from missed approach altitude to cruising level/altitude;
 - (iii) fuel for the cruise from top of climb to top of descent;
 - (iv) fuel for descent from top of descent to the point where the approach is initiated, taking into account the expected arrival procedure;
 - (v) fuel for executing an approach and landing at the destination alternate selected in accordance with CAT.OP.MPA.181; and
 - (vi) for helicopters operating to or from helidecks located in a hostile environment, 10 % of (a)(4)(i) to (v);
- (5) final reserve fuel, which should be:
- (i) for VFR flights navigating by day with reference to visual landmarks, 20 minutes' fuel at best range speed; or
 - (ii) for IFR flights or when flying VFR and navigating by means other than by reference to visual landmarks or at night, fuel to fly for 30 minutes at holding speed at 1 500 ft (450 m) above the destination aerodrome in standard conditions calculated with the estimated mass on arrival above the alternate, or the destination, when no alternate is required;
- and
- (6) extra fuel, which should be at the discretion of the commander.
- (b) Isolated aerodrome IFR procedure
- If the operator's fuel policy includes planning to an isolated aerodrome flying IFR, or when flying VFR and navigating by means other than by reference to visual landmarks, for which a destination alternate does not exist, the amount of fuel at departure should include:
- (1) taxi fuel;
 - (2) trip fuel;
 - (3) contingency fuel calculated in accordance with (a)(3);
 - (4) additional fuel to fly for 2 hours at holding speed, including final reserve fuel; and
 - (5) extra fuel at the discretion of the commander.
- (c) Sufficient fuel should be carried at all times to ensure that following the failure of an engine occurring at the most critical point along the route, the helicopter is able to:
- (1) descend as necessary and proceed to an adequate aerodrome;
 - (2) hold there for 15 minutes at 1 500 ft (450 m) above aerodrome elevation in standard conditions; and
 - (3) make an approach and landing.

GM1 CAT.OP.MPA.150(b) Fuel policy

CONTINGENCY FUEL STATISTICAL METHOD — AEROPLANES

- (a) As an example, the following values of statistical coverage of the deviation from the planned to the actual trip fuel provide appropriate statistical coverage.
- (1) 99 % coverage plus 3 % of the trip fuel, if the calculated flight time is less than 2 hours, or more than 2 hours and no weather-permissible ERA aerodrome is available.
 - (2) 99 % coverage if the calculated flight time is more than 2 hours and a weather-permissible ERA aerodrome is available.
 - (3) 90 % coverage if:
 - (i) the calculated flight time is more than 2 hours;
 - (ii) a weather-permissible ERA aerodrome is available; and
 - (iii) at the destination aerodrome two separate runways are available and usable, one of which is equipped with an ILS/MLS, and the weather conditions are in compliance with CAT.OP.MPA.180(b)(2), or the ILS/MLS is operational to CAT II/III operating minima and the weather conditions are at or above 500 ft.
- (b) The fuel consumption database used in conjunction with these values should be based on fuel consumption monitoring for each route/aeroplane combination over a rolling 2-year period.

GM1 CAT.OP.MPA.150(c)(3)(i) Fuel policy

CONTINGENCY FUEL

Factors that may influence fuel required on a particular flight in an unpredictable way include deviations of an individual aeroplane from the expected fuel consumption data, deviations from forecast meteorological conditions and deviations from planned routings and/or cruising levels/altitudes.

GM1 CAT.OP.MPA.150(c)(3)(ii) Fuel policy

DESTINATION ALTERNATE AERODROME

The departure aerodrome may be selected as the destination alternate aerodrome.

CAT.OP.MPA.151 Fuel policy — alleviations

- (a) Notwithstanding CAT.OP.MPA.150(b) to (d), for operations of performance class B aeroplanes the operator shall ensure that the pre-flight calculation of usable fuel required for a flight includes:
- (i) taxi fuel, if significant;
 - (ii) trip fuel;
 - (iii) reserve fuel, consisting of:
 - (A) contingency fuel that is not less than 5 % of the planned trip fuel or, in the event of in-flight replanning, 5 % of the trip fuel for the remainder of the flight; and
 - (B) final reserve fuel to fly for an additional period of 45 minutes for reciprocating engines or 30 minutes for turbine engines;
 - (iv) alternate fuel to reach the destination alternate aerodrome via the destination, if a destination alternate aerodrome is required; and
 - (v) extra fuel, if specified by the commander.
- (a1) Notwithstanding CAT.OP.MPA.150(b) to (d), for operations taking off and landing at the same aerodrome or operating site with ELA2 aeroplanes under VFR by day the operator shall specify the minimum final reserve fuel in the OM. This minimum final reserve fuel shall not be less than the amount needed to fly for a period of 45 minutes.
- (b) Notwithstanding CAT.OP.MPA.150(b) to (d), for helicopters with an MCTOM of 3 175 kg or less, by day and over routes navigated by reference to visual landmarks or local helicopter operations, the fuel policy shall ensure that, on completion of the flight, or series of flights the final reserve fuel is not less than an amount sufficient for:
- (1) 30 minutes flying time at normal cruising speed; or
 - (2) 20 minutes flying time at normal cruising speed when operating within an area providing continuous and suitable precautionary landing sites.

CAT.OP.MPA.155 Carriage of special categories of passengers (SCPs)

- (a) Persons requiring special conditions, assistance and/or devices when carried on a flight shall be considered as SCPs including at least:
- (1) persons with reduced mobility (PRMs) who, without prejudice to Regulation (EC) No 1107/2006, are understood to be any person whose mobility is reduced due to any physical disability, sensory or locomotory, permanent or temporary, intellectual disability or impairment, any other cause of disability, or age;
 - (2) infants and unaccompanied children; and
 - (3) deportees, inadmissible passengers or prisoners in custody.
- (b) SCPs shall be carried under conditions that ensure the safety of the aircraft and its occupants according to procedures established by the operator.
- (c) SCPs shall not be allocated, nor occupy, seats that permit direct access to emergency exits or where their presence could:
- (1) impede crew members in their duties;
 - (2) obstruct access to emergency equipment; or
 - (3) impede the emergency evacuation of the aircraft.

- (d) The commander shall be notified in advance when SCPs are to be carried on board.

AMC1 CAT.OP.MPA.155(b) Carriage of special categories of passengers (SCPs)

PROCEDURES

When establishing the procedures for the carriage of SCPs, the operator should take into account the following factors:

- (a) the aircraft type and cabin configuration;
- (b) the total number of passengers carried on board;
- (c) the number and categories of SCPs, which should not exceed the number of passengers capable of assisting them in case of an emergency; and
- (d) any other factor(s) or circumstances possibly impacting on the application of emergency procedures by the operating crew members.

AMC2 CAT.OP.MPA.155(b) Carriage of Special Categories of Passengers (SCPs)

PROCEDURES TO PROVIDE INFORMATION TO SCP

The operator procedures on information provided to the SCP should specify the timing and methods on how and when the information can be provided.

AMC3 CAT.OP.MPA.155(b) Carriage of Special Categories of Passengers (SCPs)

CONDITIONS OF SAFE CARRIAGE FOR UNACCOMPANIED CHILDREN

- (a) When carrying an unaccompanied child that is not self-reliant, the operator should assess the safety risks to ensure that the child is assisted in case of an emergency situation.
- (b) A child under the age of 12 years, separated from the accompanying adult, who is travelling in another cabin class, should be considered as an unaccompanied child in order to ensure that the child is assisted in case of an emergency situation.

GM1 CAT.OP.MPA.155(b) Carriage of Special Categories of Passengers (SCPs)

PROCEDURES TO PROVIDE INFORMATION TO SCP

Providing information only at the time of booking might not be sufficient to ensure that the SCP is aware of the information at the time of the flight.

GM2 CAT.OP.MPA.155(b) Carriage of Special Categories of Passengers (SCPs)

INFORMATION PROVIDED TO SCP

When establishing procedures on the information to be provided to an SCP, the operator should consider informing the SCP that cabin crew can only assist the SCP once the cabin has been evacuated. The following table contains additional information by SCP category:

SCP category	Type of information
Unaccompanied child	Inform the unaccompanied child on the following: (a) which adult will assist with the operation of the seat belt and the

	<p>fitting of the oxygen mask if the situation requires it;</p> <p>(b) the content of the passenger safety briefing card; and</p> <p>(c) in case of evacuation, to seek the assistance of adult passenger(s) in contacting a crew member.</p> <p>Inform the passenger sitting next to the unaccompanied child to assist with:</p> <p>(a) providing the child with an oxygen mask in case of decompression after fitting one's own mask;</p> <p>(b) securing/releasing the child's seat belt, if necessary; and</p> <p>(c) calling a cabin crew member in all other in-flight situations.</p> <p>When a child and the accompanying adult travel in a different class of cabin, information should be provided to the child and adult that, in the event of an emergency, they should follow the instructions of the cabin crew and not try to reunite inside the cabin as this would slow down the overall evacuation.</p>
Adult travelling with an infant	<p>Information on brace position for adult with lap-held infant.</p> <p>Information on the use of the loop belt, in case of a lap-held infant.</p> <p>Information to fit own oxygen mask before fitting the infant's oxygen mask.</p> <p>Information on how to evacuate when carrying an infant:</p> <p>(a) On land, jump on the slide; and</p> <p>(b) In case of ditching, how to fit and when to inflate infant flotation aid (e.g. life vest, flotation device).</p>
Physically disabled passenger (aided walking)	<p>Inform the SCP to leave mobility aid behind in an emergency evacuation.</p>
Passenger with disability of upper limbs	<p>Inform the accompanying passenger to:</p> <p>(a) fit the life jacket on the SCP, in case of a ditching evacuation;</p> <p>(b) first put on their own oxygen mask before fitting the SCP's oxygen mask, in case of decompression; and</p> <p>(c) secure/release the SCP's seat belt, if necessary.</p>
Passenger with disability of lower limbs	<p>Inform the SCP:</p> <p>(a) on the location of the nearest suitable exit; and</p> <p>(b) that mobility aids might not be accessible in an emergency evacuation.</p>
Passenger with disability of both upper and lower limbs	<p>Inform accompanying passenger to secure/release the SCP's seat belt.</p> <p>Inform the SCP:</p>

	<ul style="list-style-type: none"> (a) in case of an evacuation, on the location of the nearest suitable exit; (b) in case of a ditching evacuation, that the accompanying passenger should fit the life jacket on the SCP; and (c) in case of a decompression, that the accompanying passenger should first put on his/her own oxygen mask before fitting the SCP's oxygen mask.
Visually impaired passenger	<p>Depending on the level of impairment, inform the visually impaired passenger on the following:</p> <ul style="list-style-type: none"> (a) seat and seat belt operation; (b) location of the nearest exit (e.g. number of seat rows to the nearest exit); (c) oxygen mask deployment; (d) location of life jacket; (e) brace position; and (f) location of cabin crew call button. <p>If available, take the aircraft demonstration equipment to the passenger for tactile assistance.</p>
Passenger travelling with a recognised assistance dog in the cabin	Advise how to evacuate guide dog by holding the dog and sliding.
Stretcher occupant	<p>Inform the stretcher occupant and the accompanying passenger that in case of an evacuation:</p> <ul style="list-style-type: none"> (a) the stretcher occupant should be evacuated when the cabin area surrounding the stretcher is clear; (b) to evacuate the stretcher occupant without the stretcher, if possible; (c) to be seated when sliding, holding the stretcher occupant in front; and (d) in the event of a ditching evacuation, to fit the life jacket on the stretcher occupant.

GM3 CAT.OP.MPA.155(b) Carriage of Special Categories of Passengers (SCPs)

PROCEDURES

A passenger capable of assisting in case of an emergency means a passenger who is not an SCP and has no other role or private responsibility that would prevent him/her from assisting the SCP. For example, an adult travelling alone has no other role or private responsibility, unlike a family travelling together with younger children.

GM4 CAT.OP.MPA.155(b) Carriage of Special Categories of Passengers (SCPs)

BRIEFING PROCEDURE IN A PLANNED EMERGENCY

In a planned emergency, if time permits, passengers identified by the cabin crew as capable of assisting an SCP should be briefed on the assistance they can provide.

AMC1 CAT.OP.MPA.155(c) Carriage of Special Categories of Passengers (SCPs)

SEATING PROCEDURES

When establishing SCP seating procedures, the operator should take into account the following factors:

- (a) If the SCP travels with an accompanying passenger, the accompanying passenger should be seated next to the SCP.
- (b) If the SCP is unable to negotiate stairs within the cabin unaided, he/she should not be seated on the upper deck of a multi-deck aircraft if the exits are not certified for emergency evacuation on both land and water.

AMC2 CAT.OP.MPA.155(c) Carriage of Special Categories of Passengers (SCPs)

SEATING ALLOCATION OF SCP WITH A DISABILITY AND/OR RESTRAINT AID

- (a) A disability and/or restraint aid that requires to be secured around the back of the seat should not be used if there is a person seated behind unless the seating configuration is approved for the use of such devices. This is to avoid the changed dynamic seat reactions with the disability and/or restraint aid, which may lead to head injury of the passenger seated behind.
- (b) If the seat design or installation would prevent head contact of the person seated behind, then no further consideration is necessary.

GM1 CAT.OP.MPA.155(c) Carriage of Special categories of Passengers (SCPs)

GROUP SEATING

- (a) Taking into account access to exits, groups of non-ambulatory SCPs should be seated throughout the cabin to ensure that each SCP is surrounded by the maximum number of passengers capable of assisting in case of an emergency.
- (b) If non-ambulatory SCPs cannot be evenly distributed throughout the cabin, the operator should establish procedures to mitigate the increased safety risk such as seating of passengers capable of assisting in case of an emergency in the vicinity, additional information or training of cabin crew.
- (c) A group of passengers whose physical size would possibly prevent them from moving quickly or reaching and passing through an emergency exit, should not occupy the same seat row segment to avoid overloading the structure of the seat.

GM2 CAT.OP.MPA.155(c) Carriage of Special Categories of Passengers (SCPs)

SEATING ALLOCATION

When establishing the procedure on seating of an SCP, seats should be allocated taking into account the following:

SCP category	Seating allocation procedure
Unaccompanied child	<p>The seating allocation of an unaccompanied child should allow for visual or audible communication during all phases of the flight with cabin crew.</p> <p>Groups of unaccompanied children should be seated in mix of ages, with the tallest child seated to allow assistance with fitting drop-down oxygen mask to smaller children in case of a decompression.</p> <p>Where possible, one adult should occupy the seat across the aisle next to each row of unaccompanied children.</p>
Passenger travelling with a child of less than 12 years of age	If a child travels with an accompanying adult in the same class of cabin, the child should be seated in the same seat row segment as the accompanying adult. Where this is not possible, the child should be seated no more than one seat row or aisle away.
Passenger whose physical size would possibly prevent him/her from passing through an emergency exit	<p>A passenger whose physical size would possibly prevent him/her from passing through an emergency exit (e.g. Type III or Type IV exit), should be seated in the vicinity of a suitable exit, taking into account the size of the exit.</p> <p>Seating of more than one of such passengers in the same seat row segment should be avoided.</p>
Passenger with physical disability of the upper limbs	A passenger with a physical disability of the upper limbs travelling without an accompanying passenger should be allocated seats during all phases of the flight so that visual and audible communication can be established with the cabin crew.
Passenger with disability of lower limbs	A passenger with a disability of the lower limbs should be seated in a location providing easy access to floor level exits.
Passenger with disability of both upper and lower limbs	A passenger with a disability of both upper and lower limbs should be seated in a location providing easy access to floor level exits.
Mentally impaired passenger	A mentally impaired passenger, who travels without an accompanying passenger, should be allocated seats during all phases of the flight so that visual and audible communication can be established with the cabin crew.
Passenger travelling with recognised assistance dog in the cabin	Suitable arrangements should be made between the passenger and the operator in advance of a flight where a recognised assistance dog is to be accommodated. A suitable restraint harness should be provided by the owner to secure and restrain the dog during taxi, take-off, landing and turbulence. In cruise, it is acceptable for the dog to be subject to less restraint.

Stretcher occupant	<p>Where possible, the stretcher should be installed behind a cabin monument. Alternatively, the stretcher could be installed where it can demonstrate compliance with the appropriate certification basis (CS.25.561 and CS.25.562(b), (c)(7), (8)). Stretcher installation should be as close to the floor level non-overwing exits as practical; preferably close to a required cabin crew station with an adjacent seat for the designated accompanying passenger.</p>
--------------------	--

CAT.OP.MPA.160 Stowage of baggage and cargo

The operator shall establish procedures to ensure that:

- (a) only hand baggage that can be adequately and securely stowed is taken into the passenger compartment; and
- (b) all baggage and cargo on board that might cause injury or damage, or obstruct aisles and exits if displaced, is stowed so as to prevent movement.

AMC1 CAT.OP.MPA.160 Stowage of baggage and cargo

STOWAGE PROCEDURES

Procedures established by the operator to ensure that hand baggage and cargo are adequately and securely stowed should take account of the following:

- (a) each item carried in a cabin should be stowed only in a location that is capable of restraining it;
- (b) weight limitations placarded on or adjacent to stowages should not be exceeded;
- (c) under seat stowages should not be used unless the seat is equipped with a restraint bar and the baggage is of such size that it may adequately be restrained by this equipment;
- (d) items should not be stowed in lavatories or against bulkheads that are incapable of restraining articles against movement forwards, sideways or upwards and unless the bulkheads carry a placard specifying the greatest mass that may be placed there;
- (e) baggage and cargo placed in lockers should not be of such size that they prevent latched doors from being closed securely;
- (f) baggage and cargo should not be placed where it can impede access to emergency equipment; and
- (g) checks should be made before take-off, before landing and whenever the 'fasten seat belts' signs are illuminated or it is otherwise so ordered to ensure that baggage is stowed where it cannot impede evacuation from the aircraft or cause injury by falling (or other movement), as may be appropriate to the phase of flight.

AMC2 CAT.OP.MPA.160 Stowage of baggage and cargo

CARRIAGE OF CARGO IN THE PASSENGER COMPARTMENT

The following should be observed before carrying cargo in the passenger compartment:

- (a) for aeroplanes:
 - (1) dangerous goods should not be allowed; and
 - (2) a mix of passengers and live animals should only be allowed for pets weighing not more than 8 kg and guide dogs;
- (b) for aeroplanes and helicopters:
 - (1) the mass of cargo should not exceed the structural loading limits of the floor or seats;
 - (2) the number/type of restraint devices and their attachment points should be capable of restraining the cargo in accordance with applicable Certification Specifications; and
 - (3) the location of the cargo should be such that, in the event of an emergency evacuation, it will not hinder egress nor impair the crew's view.

CAT.OP.MPA.165 Passenger seating

The operator shall establish procedures to ensure that passengers are seated where, in the event that an emergency evacuation is required, they are able to assist and not hinder evacuation of the aircraft.

AMC1 CAT.OP.MPA.165 Passenger seating

PROCEDURES

The operator should make provision so that:

- (a) those passengers who are allocated seats that permit direct access to emergency exits appear to be reasonably fit, strong and able to assist the rapid evacuation of the aircraft in an emergency after an appropriate briefing by the crew;
- (b) in all cases, passengers who, because of their condition, might hinder other passengers during an evacuation or who might impede the crew in carrying out their duties, should not be allocated seats that permit direct access to emergency exits. If procedures cannot be reasonably implemented at the time of passenger 'check-in', the operator should establish an alternative procedure which ensures that the correct seat allocations will, in due course, be made.

AMC2 CAT.OP.MPA.165 Passenger seating

ACCESS TO EMERGENCY EXITS

The following categories of passengers are among those who should not be allocated to, or directed to, seats that permit direct access to emergency exits:

- (a) passengers suffering from obvious physical or mental disability to the extent that they would have difficulty in moving quickly if asked to do so;
- (b) passengers who are either substantially blind or substantially deaf to the extent that they might not readily assimilate printed or verbal instructions given;
- (c) passengers who because of age or sickness are so frail that they have difficulty in moving quickly;
- (d) passengers who are so obese that they would have difficulty in moving quickly or reaching and passing through the adjacent emergency exit;
- (e) children (whether accompanied or not) and infants;
- (f) deportees, inadmissible passengers or persons in custody; and
- (g) passengers with animals.

GM1 CAT.OP.MPA.165 Passenger seating

DIRECT ACCESS

'Direct access' means a seat from which a passenger can proceed directly to the exit without entering an aisle or passing around an obstruction.

CAT.OP.MPA.170 Passenger briefing

The operator shall ensure that passengers are:

- (a) given briefings and demonstrations relating to safety in a form that facilitates the application of the procedures applicable in the event of an emergency; and
- (b) provided with a safety briefing card on which picture-type instructions indicate the operation of emergency equipment and exits likely to be used by passengers.

AMC1 CAT.OP.MPA.170 Passenger briefing**PASSENGER BRIEFING**

Passenger briefings should contain the following:

- (a) Before take-off
 - (1) Passengers should be briefed on the following items if applicable:
 - (i) smoking regulations;
 - (ii) back of the seat to be in the upright position and tray table stowed;
 - (iii) location of emergency exits;
 - (iv) location and use of floor proximity escape path markings;
 - (v) stowage of hand baggage;
 - (vi) the use and stowage of portable electronic devices; and
 - (vii) the location and the contents of the safety briefing card; and
 - (2) passengers should receive a demonstration of the following:
 - (i) the use of safety belts or restraint systems, including how to fasten and unfasten the safety belts or restraint systems;
 - (ii) the location and use of oxygen equipment, if required. Passengers should also be briefed to extinguish all smoking materials when oxygen is being used; and
 - (iii) the location and use of life-jackets, if required.
- (b) After take-off
 - (1) passengers should be reminded of the following, if applicable:
 - (i) smoking regulations; and
 - (ii) use of safety belts or restraint systems including the safety benefits of having safety belts fastened when seated irrespective of seat belt sign illumination.
- (c) Before landing
 - (1) passengers should be reminded of the following, if applicable:
 - (i) smoking regulations;
 - (ii) use of safety belts or restraint systems;
 - (iii) back of the seat to be in the upright position and tray table stowed;
 - (iv) re-stowage of hand baggage; and
 - (v) the use and stowage of portable electronic devices.

- (d) After landing
 - (1) passengers should be reminded of the following:
 - (i) smoking regulations; and
 - (ii) use of safety belts and/or restraint systems.
- (e) Emergency during flight:
 - (1) passengers should be instructed as appropriate to the circumstances.

AMC1.1 CAT.OP.MPA.170 Passenger briefing

PASSENGER BRIEFING

- (a) The operator may replace the briefing/demonstration as set out in AMC1 CAT.OP.MPA.170 with a passenger training programme covering all safety and emergency procedures for a given type of aircraft.
- (b) Only passengers who have been trained according to this programme and have flown on the aircraft type within the last 90 days may be carried on board without receiving a briefing/demonstration.

AMC2 CAT.OP.MPA.170 Passenger briefing

SINGLE-PILOT OPERATIONS WITHOUT CABIN CREW

For single-pilot operations without cabin crew, the commander should provide safety briefings to passengers except during critical phases of flight and taxiing.

CAT.OP.MPA.175 Flight preparation

- (a) An operational flight plan shall be completed for each intended flight based on considerations of aircraft performance, other operating limitations and relevant expected conditions on the route to be followed and at the aerodromes/operating sites concerned.
- (b) The flight shall not be commenced unless the commander is satisfied that:
- (1) all items stipulated in 2.a.3 of Annex IV to Regulation (EC) No 216/2008 concerning the airworthiness and registration of the aircraft, instrument and equipment, mass and centre of gravity (CG) location, baggage and cargo and aircraft operating limitations can be complied with;
 - (2) the aircraft is not operated contrary to the provisions of the configuration deviation list (CDL);
 - (3) the parts of the operations manual that are required for the conduct of the flight are available;
 - (4) the documents, additional information and forms required to be available by CAT.GEN.MPA.180 are on board;
 - (5) current maps, charts and associated documentation or equivalent data are available to cover the intended operation of the aircraft including any diversion that may reasonably be expected;
 - (6) space-based facilities, ground facilities and services that are required for the planned flight are available and adequate;
 - (7) the provisions specified in the operations manual in respect of fuel, oil, oxygen, minimum safe altitudes, aerodrome operating minima and availability of alternate aerodromes, where required, can be complied with for the planned flight;
 - (7a) any navigational database required for performance-based navigation is suitable and current; and
 - (8) any additional operational limitation can be complied with.
- (c) Notwithstanding (a), an operational flight plan is not required for operations under VFR of:
- (1) other-than complex motor-powered aeroplane taking off and landing at the same aerodrome or operating site; or
 - (2) helicopters with an MCTOM of 3 175 kg or less, by day and over routes navigated by reference to visual landmarks in a local area as specified in the operations manual.

AMC1 CAT.OP.MPA.175 Flight preparation

FLIGHT PREPARATION FOR PBN OPERATIONS

- (a) The flight crew should ensure that RNAV 1, RNAV 2, RNP 1 RNP 2, and RNP APCH routes or procedures to be used for the intended flight, including for any alternate aerodromes, are selectable from the navigation database and are not prohibited by NOTAM.
- (b) The flight crew should take account of any NOTAMs or operator briefing material that could adversely affect the aircraft system operation along its flight plan including any alternate aerodromes.
- (c) When PBN relies on GNSS systems for which RAIM is required for integrity, its availability should be verified during the preflight planning. In the event of a predicted continuous loss of fault

detection of more than five minutes, the flight planning should be revised to reflect the lack of full PBN capability for that period.

- (d) For RNP 4 operations with only GNSS sensors, a fault detection and exclusion (FDE) check should be performed. The maximum allowable time for which FDE capability is projected to be unavailable on any one event is 25 minutes. If predictions indicate that the maximum allowable FDE outage will be exceeded, the operation should be rescheduled to a time when FDE is available.
- (e) For RNAV 10 operations, the flight crew should take account of the RNAV 10 time limit declared for the inertial system, if applicable, considering also the effect of weather conditions that could affect flight duration in RNAV 10 airspace. Where an extension to the time limit is permitted, the flight crew will need to ensure that en route radio facilities are serviceable before departure, and to apply radio updates in accordance with any AFM limitation.

AMC2 CAT.OP.MPA.175 Flight preparation

DATABASE SUITABILITY

- (a) The flight crew should check that any navigational database required for PBN operations includes the routes and procedures required for the flight.

DATABASE CURRENCY

- (b) The database validity (current AIRAC cycle) should be checked before the flight.
- (c) Navigation databases should be current for the duration of the flight. If the AIRAC cycle is due to change during flight, the flight crew should follow procedures established by the operator to ensure the accuracy of navigation data, including the suitability of navigation facilities used to define the routes and procedures for the flight.
- (d) An expired database may only be used if the following conditions are satisfied:
 - (1) the operator has confirmed that the parts of the database which are intended to be used during the flight and any contingencies that are reasonable to expect are not changed in the current version;
 - (2) any NOTAMs associated with the navigational data are taken into account;
 - (3) maps and charts corresponding to those parts of the flight are current and have not been amended since the last cycle;
 - (4) any MEL limitations are observed; and
 - (5) the database has expired by no more than 28 days.

AMC1 CAT.OP.MPA.175(a) Flight preparation

OPERATIONAL FLIGHT PLAN — COMPLEX MOTOR-POWERED AIRCRAFT

- (a) The operational flight plan used and the entries made during flight should contain the following items:
 - (1) aircraft registration;
 - (2) aircraft type and variant;
 - (3) date of flight;
 - (4) flight identification;

- (5) names of flight crew members;
 - (6) duty assignment of flight crew members;
 - (7) place of departure;
 - (8) time of departure (actual off-block time, take-off time);
 - (9) place of arrival (planned and actual);
 - (10) time of arrival (actual landing and on-block time);
 - (11) type of operation (ETOPS, VFR, ferry flight, etc.);
 - (12) route and route segments with checkpoints/waypoints, distances, time and tracks;
 - (13) planned cruising speed and flying times between check-points/waypoints (estimated and actual times overhead);
 - (14) safe altitudes and minimum levels;
 - (15) planned altitudes and flight levels;
 - (16) fuel calculations (records of in-flight fuel checks);
 - (17) fuel on board when starting engines;
 - (18) alternate(s) for destination and, where applicable, take-off and en-route, including information required in (a)(12) to (15);
 - (19) initial ATS flight plan clearance and subsequent reclearance;
 - (20) in-flight replanning calculations; and
 - (21) relevant meteorological information.
- (b) Items that are readily available in other documentation or from another acceptable source or are irrelevant to the type of operation may be omitted from the operational flight plan.
- (c) The operational flight plan and its use should be described in the operations manual.
- (d) All entries on the operational flight plan should be made concurrently and be permanent in nature.

OPERATIONAL FLIGHT PLAN — OTHER-THAN-COMPLEX MOTOR-POWERED AIRCRAFT OPERATIONS AND LOCAL OPERATIONS

An operational flight plan may be established in a simplified form relevant to the kind of operation for operations with other-than-complex motor-powered aircraft as well as local operations with any aircraft.

GM1 CAT.OP.MPA.175(b)(5) Flight preparation

CONVERSION TABLES

The documentation should include any conversion tables necessary to support operations where metric heights, altitudes and flight levels are used.

CAT.OP.MPA.180 Selection of aerodromes — aeroplanes

- (a) Where it is not possible to use the departure aerodrome as a take-off alternate aerodrome due to meteorological or performance reasons, the operator shall select another adequate take-off alternate aerodrome that is no further from the departure aerodrome than:
- (1) for two-engined aeroplanes:
 - (i) one hour flying time at an OEI cruising speed according to the AFM in still air standard conditions based on the actual take-off mass; or
 - (ii) the ETOPS diversion time approved in accordance with Annex V (Part-SPA), Subpart F, subject to any MEL restriction, up to a maximum of two hours, at the OEI cruising speed according to the AFM in still air standard conditions based on the actual take-off mass;
 - (2) for three and four-engined aeroplanes, two hours flying time at the OEI cruising speed according to the AFM in still air standard conditions based on the actual take-off mass.
- If the AFM does not contain an OEI cruising speed, the speed to be used for calculation shall be that which is achieved with the remaining engine(s) set at maximum continuous power.
- (b) The operator shall select at least one destination alternate aerodrome for each instrument flight rules (IFR) flight unless the destination aerodrome is an isolated aerodrome or:
- (1) the duration of the planned flight from take-off to landing or, in the event of in-flight replanning in accordance with CAT.OP.MPA.150(d), the remaining flying time to destination does not exceed six hours; and
 - (2) two separate runways are available and usable at the destination aerodrome and the appropriate weather reports and/or forecasts for the destination aerodrome indicate that, for the period from one hour before until one hour after the expected time of arrival at the destination aerodrome, the ceiling will be at least 2 000 ft or circling height + 500 ft, whichever is greater, and the ground visibility will be at least 5 km.
- (c) The operator shall select two destination alternate aerodromes when:
- (1) the appropriate weather reports and/or forecasts for the destination aerodrome indicate that during a period commencing one hour before and ending one hour after the estimated time of arrival, the weather conditions will be below the applicable planning minima; or
 - (2) no meteorological information is available.
- (d) The operator shall specify any required alternate aerodrome(s) in the operational flight plan.

CAT.OP.MPA.181 Selection of aerodromes and operating sites — helicopters

- (a) For flights under instrument meteorological conditions (IMC), the commander shall select a take-off alternate aerodrome within one hour flying time at normal cruising speed if it would not be possible to return to the site of departure due to meteorological reasons.
- (b) For IFR flights or when flying under VFR and navigating by means other than by reference to visual landmarks, the commander shall specify at least one destination alternate aerodrome in the operational flight plan unless:
- (1) the destination is a coastal aerodrome and the helicopter is routing from offshore;
 - (2) for a flight to any other land destination, the duration of the flight and the meteorological conditions prevailing are such that, at the estimated time of arrival at the site of intended

Applicable until 01 July 2018, then replaced by the IR below

- landing, an approach and landing is possible under visual meteorological conditions (VMC);
or
- (3) the site of intended landing is isolated and no alternate is available; in this case, a point of no return (PNR) shall be determined.
- (c) The operator shall select two destination alternate aerodromes when:
- (1) the appropriate weather reports and/or forecasts for the destination aerodrome indicate that during a period commencing one hour before and ending one hour after the estimated time of arrival, the weather conditions will be below the applicable planning minima; or
- (2) no meteorological information is available for the destination aerodrome.
- (d) The operator may select off-shore destination alternate aerodromes when the following criteria are applied:
- (1) an off-shore destination alternate aerodrome shall be used only after a PNR. Prior to the PNR, on-shore alternate aerodromes shall be used;
- (2) OEI landing capability shall be attainable at the alternate aerodrome;
- (3) to the extent possible, deck availability shall be guaranteed. The dimensions, configuration and obstacle clearance of individual helidecks or other sites shall be assessed in order to establish operational suitability for use as an alternate aerodrome by each helicopter type proposed to be used;
- (4) weather minima shall be established taking accuracy and reliability of meteorological information into account;
- (5) the MEL shall contain specific provisions for this type of operation; and
- (6) an off-shore alternate aerodrome shall only be selected if the operator has established a procedure in the operations manual.
- (e) The operator shall specify any required alternate aerodrome(s) in the operational flight plan.

CAT.OP.MPA.181 Selection of aerodromes and operating sites — helicopters

- (a) For flights under instrument meteorological conditions (IMC), the commander shall select a take-off alternate aerodrome within one hour flying time at normal cruising speed if it would not be possible to return to the site of departure due to meteorological reasons.
- (b) For IFR flights or when flying under VFR and navigating by means other than by reference to visual landmarks, the commander shall specify at least one destination alternate aerodrome in the operational flight plan unless:
- (1) for a flight to any other land destination, the duration of the flight and the meteorological conditions prevailing are such that, at the estimated time of arrival at the site of intended landing, an approach and landing is possible under visual meteorological conditions (VMC);
or
- (2) the site of intended landing is isolated and no alternate is available; in this case, a point of no return (PNR) shall be determined.
- (c) The operator shall select two destination alternate aerodromes when:
- (1) the appropriate weather reports and/or forecasts for the destination aerodrome indicate that during a period commencing one hour before and ending one hour after the estimated time of arrival, the weather conditions will be below the applicable planning minima; or

Applicable from 01 July 2018. Will replace the IR above.

- (2) no meteorological information is available for the destination aerodrome.
- (d) The operator shall specify any required alternate aerodrome(s) in the operational flight plan.

Applicable until 01 July 2018, then deleted.

AMC1 CAT.OP.MPA.181(b)(1) Selection of aerodromes and operating sites — helicopters

COASTAL AERODROME

- (a) Any alleviation from the requirement to select an alternate aerodrome for a flight to a coastal aerodrome under IFR routing from offshore should be based on an individual safety case assessment.
- (b) The following should be taken into account:
 - (1) suitability of the weather based on the landing forecast for the destination;
 - (2) the fuel required to meet the IFR requirements of CAT.OP.MPA.150 less alternate fuel;
 - (3) where the destination coastal aerodrome is not directly on the coast it should be:
 - (i) within a distance that, with the fuel specified in (b)(2), the helicopter can, at any time after crossing the coastline, return to the coast, descend safely and carry out a visual approach and landing with VFR fuel reserves intact; and
 - (ii) geographically sited so that the helicopter can, within the rules of the air, and within the landing forecast:
 - (A) proceed inbound from the coast at 500 ft AGL and carry out a visual approach and landing; or
 - (B) proceed inbound from the coast on an agreed route and carry out a visual approach and landing;
 - (4) procedures for coastal aerodromes should be based on a landing forecast no worse than:
 - (i) by day, a cloud base of DH/MDH +400 ft, and a visibility of 4 km, or, if descent over the sea is intended, a cloud base of 600 ft and a visibility of 4 km; or
 - (ii) by night, a cloud base of 1 000 ft and a visibility of 5 km;
 - (5) the descent to establish visual contact with the surface should take place over the sea or as part of the instrument approach;
 - (6) routings and procedures for coastal aerodromes nominated as such should be included in the operations manual, Part C;
 - (7) the MEL should reflect the requirement for airborne radar and radio altimeter for this type of operation; and
 - (8) operational limitations for each coastal aerodrome should be specified in the operations manual.

GM1 CAT.OP.MPA.181 Selection of aerodromes and operating sites — helicopters

OFFSHORE ALTERNATES

When operating offshore, any spare payload capacity should be used to carry additional fuel if it would facilitate the use of an onshore alternate aerodrome.

This paragraph is applicable until 01 July 2018, then deleted. The rest of GM remains applicable.

LANDING FORECAST

- (a) Meteorological data have been specified that conform to the standards contained in the Regional Air Navigation Plan and ICAO Annex 3. As the following meteorological data are point-specific, caution should be exercised when associating it with nearby aerodromes (or helidecks).
- (b) Meteorological reports (METARs)
 - (1) Routine and special meteorological observations at offshore installations should be made during periods and at a frequency agreed between the meteorological authority and the operator concerned. They should comply with the provisions contained in the meteorological section of the ICAO Regional Air Navigation Plan, and should conform to the standards and recommended practices, including the desirable accuracy of observations, promulgated in ICAO Annex 3.
 - (2) Routine and selected special reports are exchanged between meteorological offices in the METAR or SPECI (aviation selected special weather report) code forms prescribed by the World Meteorological Organisation.
- (c) Aerodrome forecasts (TAFs)
 - (1) The aerodrome forecast consists of a concise statement of the mean or average meteorological conditions expected at an aerodrome or aerodrome during a specified period of validity, which is normally not less than 9 hours, or more than 24 hours in duration. The forecast includes surface wind, visibility, weather and cloud, and expected changes of one or more of these elements during the period. Additional elements may be included as agreed between the meteorological authority and the operators concerned. Where these forecasts relate to offshore installations, barometric pressure and temperature should be included to facilitate the planning of helicopter landing and take-off performance.
 - (2) Aerodrome forecasts are most commonly exchanged in the TAF code form, and the detailed description of an aerodrome forecast is promulgated in the ICAO Regional Air Navigation Plan and also in ICAO Annex 3, together with the operationally desirable accuracy elements. In particular, the observed cloud height should remain within $\pm 30\%$ of the forecast value in 70 % of cases, and the observed visibility should remain within $\pm 30\%$ of the forecast value in 80 % of cases.
- (d) Landing forecasts (TRENDS)
 - (1) The landing forecast consists of a concise statement of the mean or average meteorological conditions expected at an aerodrome or aerodrome during the two-hour period immediately following the time of issue. It contains surface wind, visibility, significant weather and cloud elements and other significant information, such as barometric pressure and temperature, as may be agreed between the meteorological authority and the operators concerned.
 - (2) The detailed description of the landing forecast is promulgated in the ICAO Regional Air Navigation Plan and also in ICAO Annex 3, together with the operationally desirable accuracy of the forecast elements. In particular, the value of the observed cloud height and visibility elements should remain within $\pm 30\%$ of the forecast values in 90 % of the cases.
 - (3) Landing forecasts most commonly take the form of routine or special selected meteorological reports in the METAR code, to which either the code words 'NOSIG', i.e. no significant change expected; 'BECMG' (becoming), or 'TEMPO' (temporarily), followed by

the expected change, are added. The 2-hour period of validity commences at the time of the meteorological report.

Applicable until 01 July 2018, then deleted.

AMC1 CAT.OP.MPA.181(d) Selection of aerodromes and operating sites — helicopters

OFFSHORE ALTERNATES

(a) Offshore alternate helideck landing environment

The landing environment of a helideck that is proposed for use as an offshore alternate should be pre-surveyed and, as well as the physical characteristics, the effect of wind direction and strength, and turbulence established. This information, which should be available to the commander at the planning stage and in flight, should be published in an appropriate form in the operations manual Part C (including the orientation of the helideck) such that the suitability of the helideck for use as an offshore alternate aerodrome can be assessed. The alternate helideck should meet the criteria for size and obstacle clearance appropriate to the performance requirements of the type of helicopter concerned.

(b) Performance considerations

The use of an offshore alternate is restricted to helicopters which can achieve OEI in ground effect (IGE) hover at an appropriate power rating at the offshore alternate aerodrome. Where the surface of the offshore alternate helideck, or prevailing conditions (especially wind velocity), precludes an OEI IGE, OEI out of ground effect (OGE) hover performance at an appropriate power rating should be used to compute the landing mass. The landing mass should be calculated from graphs provided in the relevant Part B of the operations manual. When arriving at this landing mass, due account should be taken of helicopter configuration, environmental conditions and the operation of systems that have an adverse effect on performance. The planned landing mass of the helicopter including crew, passengers, baggage, cargo plus 30 minutes final reserve fuel, should not exceed the OEI landing mass at the time of approach to the offshore alternate aerodrome.

(c) Weather considerations

(1) Meteorological observations

When the use of an offshore alternate helideck is planned, the meteorological observations at the destination and alternate aerodrome should be taken by an observer acceptable to the authority responsible for the provision of meteorological services. Automatic meteorological observations stations may be used.

(2) Weather minima

When the use of an offshore alternate helideck is planned, the operator should not select a helideck as a destination or offshore alternate helideck unless the aerodrome forecast indicates that, during a period commencing 1 hour before and ending 1 hour after the expected time of arrival at the destination and offshore alternate aerodrome, the weather conditions will be at or above the planning minima shown in Table 1 below.

Table 1

Planning minima

	Day	Night
Cloud Base	600 ft	800 ft

Visibility	4 km	5 km
------------	------	------

(3) Conditions of fog

Where fog is forecast, or has been observed within the last 2 hours within 60 NM of the destination or alternate aerodrome, offshore alternate aerodromes should not be used.

(d) Actions at point of no return

Before passing the point of no return — which should not be more than 30 minutes from the destination — the following actions should have been completed:

- (1) confirmation that navigation to the destination and offshore alternate helideck can be assured;
- (2) radio contact with the destination and offshore alternate helideck (or master station) has been established;
- (3) the landing forecast at the destination and offshore alternate helideck have been obtained and confirmed to be at or above the required minima;
- (4) the requirements for OEI landing (see (b)) have been checked in the light of the latest reported weather conditions to ensure that they can be met; and
- (5) to the extent possible, having regard to information on current and forecast use of the offshore alternate helideck and on conditions prevailing, the availability of the offshore alternate helideck should be guaranteed by the duty holder (the rig operator in the case of fixed installations and the owner in the case of mobiles) until the landing at the destination, or the offshore alternate aerodrome, has been achieved or until offshore shuttling has been completed.

(e) Offshore shuttling

Provided that the actions in (d) have been completed, offshore shuttling, using an offshore alternate aerodrome, may be carried out.

CAT.OP.MPA.182 Destination alternate aerodromes — instrument approach operations

The operator shall ensure that sufficient means are available to navigate and land at the destination aerodrome or at any destination alternate aerodrome in the case of loss of capability for the intended approach and landing operation.

AMC1 CAT.OP.MPA.182 Destination aerodromes — instrument approach operations

PBN OPERATIONS

The pilot-in-command should only select an aerodrome as a destination alternate aerodrome if an instrument approach procedure that does not rely on GNSS is available either at that aerodrome or at the destination aerodrome.

GM1 CAT.OP.MPA.182 Destination aerodromes — instrument approach operations

INTENT OF AMC1

- (a) The limitation applies only to destination alternate aerodromes for flights when a destination alternate aerodrome is required. A take-off or en route alternate aerodrome with instrument approach procedures relying on GNSS may be planned without restrictions. A destination aerodrome with all instrument approach procedures relying solely on GNSS may be used without a destination alternate aerodrome if the conditions for a flight without a destination alternate aerodrome are met.
- (b) The term 'available' means that the procedure can be used in the planning stage and complies with planning minima requirements.

CAT.OP.MPA.185 Planning minima for IFR flights — aeroplanes*(a) Planning minima for a take-off alternate aerodrome*

The operator shall only select an aerodrome as a take-off alternate aerodrome when the appropriate weather reports and/or forecasts indicate that, during a period commencing one hour before and ending one hour after the estimated time of arrival at the aerodrome, the weather conditions will be at or above the applicable landing minima specified in accordance with CAT.OP.MPA.110. The ceiling shall be taken into account when the only approach operations available are non-precision approaches (NPA) and/or circling operations. Any limitation related to OEI operations shall be taken into account.

(b) Planning minima for a destination aerodrome other than an isolated destination aerodrome

The operator shall only select the destination aerodrome when:

- (1) the appropriate weather reports and/or forecasts indicate that, during a period commencing one hour before and ending one hour after the estimated time of arrival at the aerodrome, the weather conditions will be at or above the applicable planning minima as follows:
 - (i) RVR/visibility (VIS) specified in accordance with CAT.OP.MPA.110; and
 - (ii) for an NPA or a circling operation, the ceiling at or above MDH;
 or
- (2) two destination alternate aerodromes are selected.

(c) Planning minima for a destination alternate aerodrome, isolated aerodrome, fuel en-route alternate (fuel ERA) aerodrome, en-route alternate (ERA) aerodrome

The operator shall only select an aerodrome for one of these purposes when the appropriate weather reports and/or forecasts indicate that, during a period commencing one hour before and ending one hour after the estimated time of arrival at the aerodrome, the weather conditions will be at or above the planning minima in Table 1.

Table 1

Planning minima

Destination alternate aerodrome, isolated destination aerodrome, fuel ERA and ERA aerodrome

Type of approach	Planning minima
CAT II and III	CAT I RVR
CAT I	NPA RVR/VIS Ceiling shall be at or above MDH
NPA	NPA RVR/VIS + 1 000 m Ceiling shall be at or above MDH + 200 ft
Circling	Circling

GM1 CAT.OP.MPA.185 Planning minima for IFR flights — aeroplanes

PLANNING MINIMA FOR ALTERNATE AERODROMES

Non-precision minima (NPA) in Table 1 of CAT.OP.MPA.185 mean the next highest minima that apply in the prevailing wind and serviceability conditions. Localiser only approaches, if published, are considered to be non-precision in this context. It is recommended that operators wishing to publish tables of planning minima choose values that are likely to be appropriate on the majority of occasions (e.g. regardless of wind direction). Unserviceabilities should, however, be fully taken into account.

As Table 1 does not include planning minima requirements for APV, lower than standard (LTS) CAT I and other than standard (OTS) CAT II operations, the operator may use the following minima:

- (a) for APV operations — NPA or CAT I minima, depending on the DH/MDH;
- (b) for LTS CAT I operations — CAT I minima; and
- (c) for OTS CAT II operations — CAT II minima.

GM2 CAT.OP.MPA.185 Planning minima for IFR flights — aeroplanes

AERODROME WEATHER FORECASTS

APPLICATION OF AERODROME FORECASTS (TAF & TREND) TO PRE-FLIGHT PLANNING (ICAO Annex 3 refers)

1. APPLICATION OF INITIAL PART OF TAF

a) Application time period: From the start of the TAF validity period up to the time of applicability of the first subsequent ‘FM...*’ or ‘BECMG’, or if no ‘FM’ or ‘BECMG’ is given, up to the end of the validity period of the TAF.

b) Application of forecast: The prevailing weather conditions forecast in the initial part of the TAF should be fully applied with the exception of the **mean wind and gusts (and crosswind)** which should be applied in accordance with the policy in the column ‘BECMG AT and FM’ in the table below. This may however be overdue temporarily by a ‘TEMPO’ or ‘PROB**’ if applicable according to the table below.

2. APPLICATION OF FORECAST FOLLOWING CHANGE INDICATION IN TAF AND TREND

TAF or TREND for AERODROME PLANNED AS:	FM (alone) and BECMG AT:	BECMG (alone), BECMG FM, BECMG TL, BECMG FM...*TL, in case of:		TEMPO (alone), TEMPO FM, TEMPO FM...TL, PROB30/40 (alone)		PROB TEMPO	
	Deterioration and Improvement	Deterioration	Improvement	Deterioration		Improvement	Deterioration and Improvement
				Transient/Shower Conditions in connection with short- lived weather phenomena, e.g. thunderstorms, showers	Persistent Conditions in connection with e.g. haze, mist, fog, dust/sandstorm, continuous precipitations	In any case	
DESTINATION at ETA ± 1 HR	Applicable from the start of the change	Applicable from the time of the start of the change	Applicable from the time of the end of the change	Not applicable	Applicable		Deterioration may be disregarded. Improvement should be disregarded including mean wind and gusts.
TAKE – OFF ALTERNATE at ETA ± 1 HR	Mean wind: Should be within required limits	Mean wind: Should be within required limits	Mean wind: Should be within required limits	Mean wind and gusts exceeding required limits may be disregarded	Mean wind: Should be within required limits	Should be disregarded	
DEST. ALTERNATE at ETA ± 1 HR	Gusts: May be disregarded	Gusts: May be disregarded	Gusts: May be disregarded		Gusts: May be disregarded		
EN-ROUTE ALTERNATE at ETA ± 1 HR							

	Applicable from the time of start of change	Applicable from the time of start of change	Applicable from the time of end of change	Applicable if below applicable landing minima	Applicable if below applicable landing minima		
ETOPS ENRT ALTN at earliest/latest ETA ± 1 HR	Mean wind: should be within required limits	Mean wind: should be within required limits	Mean wind: should be within required limits	Mean wind: Should be within required limits	Mean wind: Should be within required limits		
	Gusts exceeding crosswind limits should be fully applied	Gusts exceeding crosswind limits should be fully applied	Gusts exceeding crosswind limits should be fully applied	Gusts exceeding crosswind limits should be fully applied	Gusts exceeding crosswind limits should be fully applied		
	<p>Note 1: 'Required limits' are those contained in the Operations Manual.</p> <p>Note 2: If promulgated aerodrome forecasts do not comply with the requirements of ICAO Annex 3, operators should ensure that guidance in the application of these reports is provided.</p> <p>* The space following 'FM' should always include a time group e.g. 'FM1030'.</p>						

CAT.OP.MPA.186 Planning minima for IFR flights — helicopters*(a) Planning minima for take-off alternate aerodrome(s)*

The operator shall only select an aerodrome or landing site as a take-off alternate aerodrome when the appropriate weather reports and/or forecasts indicate that, during a period commencing one hour before and ending one hour after the estimated time of arrival at the take-off alternate aerodrome, the weather conditions will be at or above the applicable landing minima specified in accordance with CAT.OP.MPA.110. The ceiling shall be taken into account when the only approach operations available are NPA operations. Any limitation related to OEI operations shall be taken into account.

(b) Planning minima for destination aerodrome and destination alternate aerodrome(s)

The operator shall only select the destination and/or destination alternate aerodrome(s) when the appropriate weather reports and/or forecasts indicate that, during a period commencing one hour before and ending one hour after the estimated time of arrival at the aerodrome or operating site, the weather conditions will be at or above the applicable planning minima as follows:

- (1) except as provided in CAT.OP.MPA.181(d), planning minima for a destination aerodrome shall be:
 - (i) RVR/VIS specified in accordance with CAT.OP.MPA.110; and
 - (ii) for NPA operations, the ceiling at or above MDH;
- (2) planning minima for destination alternate aerodrome(s) are as shown in Table 1.

*Table 1***Planning minima destination alternate aerodrome**

Type of approach	Planning minima
CAT II and III	CAT I RVR
CAT I	CAT I + 200 ft/400 m visibility
NPA	NPA RVR/VIS + 400 m Ceiling shall be at or above MDH + 200 ft

GM1 CAT.OP.MPA.186 Planning minima for IFR flights — helicopters**PLANNING MINIMA FOR ALTERNATE AERODROMES**

Non-precision minima (NPA) in Table 1 of CAT.OP.MPA.186 mean the next highest minima that apply in the prevailing wind and serviceability conditions. Localiser only approaches, if published, are considered to be non-precision in this context. It is recommended that operators wishing to publish tables of planning minima choose values that are likely to be appropriate on the majority of occasions (e.g. regardless of wind direction). Unserviceabilities should, however, be fully taken into account.

As Table 1 does not include planning minima requirements for APV, LTS CAT I and OTS CAT II operations, the operator may use the following minima:

- (a) for APV operations — NPA or CAT I minima, depending on the DH/MDH;
- (b) for LTS CAT I operations — CAT I minima; and
- (c) for OTS CAT II operations — CAT II minima.

CAT.OP.MPA.190 Submission of the ATS flight plan

- (a) If an ATS flight plan is not submitted because it is not required by the rules of the air, adequate information shall be deposited in order to permit alerting services to be activated if required.
- (b) When operating from a site where it is impossible to submit an ATS flight plan, the ATS flight plan shall be transmitted as soon as possible after take-off by the commander or the operator.

AMC1 CAT.OP.MPA.190 Submission of the ATS flight plan

FLIGHTS WITHOUT ATS FLIGHT PLAN

- (a) When unable to submit or to close the ATS flight plan due to lack of ATS facilities or any other means of communications to ATS, the operator should establish procedures, instructions and a list of nominated persons to be responsible for alerting search and rescue services.
- (b) To ensure that each flight is located at all times, these instructions should:
 - (1) provide the nominated person with at least the information required to be included in a VFR flight plan, and the location, date and estimated time for re-establishing communications;
 - (2) if an aircraft is overdue or missing, provide for notification to the appropriate ATS or search and rescue facility; and
 - (3) provide that the information will be retained at a designated place until the completion of the flight.

CAT.OP.MPA.195 Refuelling/defuelling with passengers embarking, on board or disembarking

- (a) An aircraft shall not be refuelled/defuelled with Avgas (aviation gasoline) or wide-cut type fuel or a mixture of these types of fuel, when passengers are embarking, on board or disembarking.
- (b) For all other types of fuel, necessary precautions shall be taken and the aircraft shall be properly manned by qualified personnel ready to initiate and direct an evacuation of the aircraft by the most practical and expeditious means available.

AMC1 CAT.OP.MPA.195 Refuelling/defuelling with passengers embarking, on board or disembarking

OPERATIONAL PROCEDURES — GENERAL

- (a) When refuelling/defuelling with passengers on board, ground servicing activities and work inside the aircraft, such as catering and cleaning, should be conducted in such a manner that they do not create a hazard and allow emergency evacuation to take place through those aisles and exits intended for emergency evacuation.
- (b) The deployment of integral aircraft stairs or the opening of emergency exits as a prerequisite to refuelling is not necessarily required.

OPERATIONAL PROCEDURES — AEROPLANES

- (c) Operational procedures should specify that at least the following precautions are taken:
 - (1) one qualified person should remain at a specified location during fuelling operations with passengers on board. This qualified person should be capable of handling emergency procedures concerning fire protection and firefighting, handling communications, and initiating and directing an evacuation;
 - (2) two-way communication should be established and should remain available by the aeroplane's inter-communication system or other suitable means between the ground crew supervising the refuelling and the qualified personnel on board the aeroplane; the involved personnel should remain within easy reach of the system of communication;
 - (3) crew, personnel and passengers should be warned that re/defuelling will take place;
 - (4) 'Fasten Seat Belts' signs should be off;
 - (5) 'NO SMOKING' signs should be on, together with interior lighting to enable emergency exits to be identified;
 - (6) passengers should be instructed to unfasten their seat belts and refrain from smoking;
 - (7) the minimum required number of cabin crew should be on board and be prepared for an immediate emergency evacuation;
 - (8) if the presence of fuel vapour is detected inside the aeroplane, or any other hazard arises during re/defuelling, fuelling should be stopped immediately;
 - (9) the ground area beneath the exits intended for emergency evacuation and slide deployment areas should be kept clear at doors where stairs are not in position for use in the event of evacuation; and
 - (10) provision is made for a safe and rapid evacuation.

OPERATIONAL PROCEDURES — HELICOPTERS

- (d) Operational procedures should specify that at least the following precautions are taken:

-
- (1) door(s) on the refuelling side of the helicopter remain closed;
 - (2) door(s) on the non-refuelling side of the helicopter remain open, weather permitting;
 - (3) firefighting facilities of the appropriate scale be positioned so as to be immediately available in the event of a fire;
 - (4) sufficient personnel be immediately available to move passengers clear of the helicopter in the event of a fire;
 - (5) sufficient qualified personnel be on board and be prepared for an immediate emergency evacuation;
 - (6) if the presence of fuel vapour is detected inside the helicopter, or any other hazard arises during refuelling/defuelling, fuelling be stopped immediately;
 - (7) the ground area beneath the exits intended for emergency evacuation be kept clear; and
 - (8) provision is made for a safe and rapid evacuation.

CAT.OP.MPA.200 Refuelling/defuelling with wide-cut fuel

Refuelling/defuelling with wide-cut fuel shall only be conducted if the operator has established appropriate procedures taking into account the high risk of using wide-cut fuel types.

GM1 CAT.OP.MPA.200 Refuelling/defuelling with wide-cut fuel

PROCEDURES

- (a) 'Wide-cut fuel' (designated JET B, JP-4 or AVTAG) is an aviation turbine fuel that falls between gasoline and kerosene in the distillation range and consequently, compared to kerosene (JET A or JET A1), it has the properties of higher volatility (vapour pressure), lower flash point and lower freezing point.
- (b) Wherever possible, the operator should avoid the use of wide-cut fuel types. If a situation arises such that only wide-cut fuels are available for refuelling/defuelling, operators should be aware that mixtures of wide-cut fuels and kerosene turbine fuels can result in the air/fuel mixture in the tank being in the combustible range at ambient temperatures. The extra precautions set out below are advisable to avoid arcing in the tank due to electrostatic discharge. The risk of this type of arcing can be minimised by the use of a static dissipation additive in the fuel. When this additive is present in the proportions stated in the fuel specification, the normal fuelling precautions set out below are considered adequate.
- (c) Wide-cut fuel is considered to be 'involved' when it is being supplied or when it is already present in aircraft fuel tanks.
- (d) When wide-cut fuel has been used, this should be recorded in the technical log. The next two uplifts of fuel should be treated as though they too involved the use of wide-cut fuel.
- (e) When refuelling/defuelling with turbine fuels not containing a static dissipator, and where wide-cut fuels are involved, a substantial reduction on fuelling flow rate is advisable. Reduced flow rate, as recommended by fuel suppliers and/or aeroplane manufacturers, has the following benefits:
 - (1) it allows more time for any static charge build-up in the fuelling equipment to dissipate before the fuel enters the tank;
 - (2) it reduces any charge which may build up due to splashing; and
 - (3) until the fuel inlet point is immersed, it reduces misting in the tank and consequently the extension of the flammable range of the fuel.
- (f) The flow rate reduction necessary is dependent upon the fuelling equipment in use and the type of filtration employed on the aeroplane fuelling distribution system. It is difficult, therefore, to quote precise flow rates. Reduction in flow rate is advisable whether pressure fuelling or over-wing fuelling is employed.
- (g) With over-wing fuelling, splashing should be avoided by making sure that the delivery nozzle extends as far as practicable into the tank. Caution should be exercised to avoid damaging bag tanks with the nozzle.

CAT.OP.MPA.205 Push back and towing — aeroplanes

Push back and towing procedures specified by the operator shall be conducted in accordance with established aviation standards and procedures.

AMC1 CAT.OP.MPA.205 Push back and towing — aeroplanes

BARLESS TOWING

- (a) Barless towing should be based on the applicable SAE ARP (Aerospace Recommended Practices), i.e. 4852B/4853B/5283/5284/5285 (as amended).
- (b) Pre- or post-taxi positioning of the aeroplanes should only be executed by barless towing if one of the following conditions are met:
 - (1) an aeroplane is protected by its own design from damage to the nose wheel steering system;
 - (2) a system/procedure is provided to alert the flight crew that damage referred to in (b)(1) may have or has occurred;
 - (3) the towing vehicle is designed to prevent damage to the aeroplane type; or
 - (4) the aeroplane manufacturer has published procedures and these are included in the operations manual.

CAT.OP.MPA.210 Crew members at stations*(a) Flight crew members*

- (1) During take-off and landing each flight crew member required to be on duty in the flight crew compartment shall be at the assigned station.
- (2) During all other phases of flight each flight crew member required to be on duty in the flight crew compartment shall remain at the assigned station, unless absence is necessary for the performance of duties in connection with the operation or for physiological needs, provided at least one suitably qualified pilot remains at the controls of the aircraft at all times.
- (3) During all phases of flight each flight crew member required to be on duty in the flight crew compartment shall remain alert. If a lack of alertness is encountered, appropriate countermeasures shall be used. If unexpected fatigue is experienced, a controlled rest procedure, organised by the commander, may be used if workload permits. Controlled rest taken in this way shall not be considered to be part of a rest period for purposes of calculating flight time limitations nor used to justify any extension of the duty period.

(b) Cabin crew members

During critical phases of flight, each cabin crew member shall be seated at the assigned station and shall not perform any activities other than those required for the safe operation of the aircraft.

AMC1 CAT.OP.MPA.210(b) Crew members at stations

CABIN CREW SEATING POSITIONS

- (a) When determining cabin crew seating positions, the operator should ensure that they are:
 - (1) close to a floor level door/exit;
 - (2) provided with a good view of the area(s) of the passenger cabin for which the cabin crew member is responsible; and
 - (3) evenly distributed throughout the cabin, in the above order of priority.
- (b) Item (a) should not be taken as implying that, in the event of there being more cabin crew stations than required cabin crew, the number of cabin crew members should be increased.

GM1 CAT.OP.MPA.210 Crew members at stations

MITIGATING MEASURES — CONTROLLED REST

- (a) This GM addresses controlled rest taken by the minimum certified flight crew. It is not related to planned in-flight rest by members of an augmented crew.
- (b) Although flight crew members should stay alert at all times during flight, unexpected fatigue can occur as a result of sleep disturbance and circadian disruption. To cover for this unexpected fatigue, and to regain a high level of alertness, a controlled rest procedure in the flight crew compartment, organised by the commander may be used, if workload permits and a controlled rest procedure is described in the operations manual. 'Controlled rest' means a period of time 'off task' that may include actual sleep. The use of controlled rest has been shown to significantly increase the levels of alertness during the later phases of flight, particularly after the top of descent, and is considered to be good use of crew resource management (CRM) principles. Controlled rest should be used in conjunction with other on-board fatigue management

- countermeasures such as physical exercise, bright cockpit illumination at appropriate times, balanced eating and drinking, and intellectual activity.
- (c) Controlled rest taken in this way should not be considered to be part of a rest period for the purposes of calculating flight time limitations, nor used to justify any duty period. Controlled rest may be used to manage both sudden unexpected fatigue and fatigue that is expected to become more severe during higher workload periods later in the flight. Controlled rest is not related to fatigue management, which is planned before flight.
 - (d) Controlled rest periods should be agreed according to individual needs and the accepted principles of CRM; where the involvement of the cabin crew is required, consideration should be given to their workload.
 - (e) When applying controlled rest procedures, the commander should ensure that:
 - (1) the other flight crew member(s) is (are) adequately briefed to carry out the duties of the resting flight crew member;
 - (2) one flight crew member is fully able to exercise control of the aircraft at all times; and
 - (3) any system intervention that would normally require a cross-check according to multi-crew principles is avoided until the resting flight crew member resumes his/her duties.
 - (f) Controlled rest procedures should satisfy all of the following criteria:
 - (1) Only one flight crew member at a time should take rest at his/her station; the restraint device should be used and the seat positioned to minimise unintentional interference with the controls.
 - (2) The rest period should be no longer than 45 minutes (in order to limit any actual sleep to approximately 30 minutes) to limit deep sleep and associated long recovery time (sleep inertia).
 - (3) After this 45-minute period, there should be a recovery period of 20 minutes to overcome sleep inertia during which control of the aircraft should not be entrusted to the flight crew member. At the end of this recovery period, an appropriate briefing should be given.
 - (4) In the case of two-crew operations, means should be established to ensure that the non-resting flight crew member remains alert. This may include:
 - (i) appropriate alarm systems;
 - (ii) on-board systems to monitor flight crew activity; and
 - (iii) frequent cabin crew checks. In this case, the commander should inform the senior cabin crew member of the intention of the flight crew member to take controlled rest, and of the time of the end of that rest; frequent contact should be established between the non-resting flight crew member and the cabin crew by communication means, and the cabin crew should check that the resting flight crew member is awake at the end of the period.
 - (5) There should be a minimum of 20 minutes between two subsequent controlled rest periods in order to overcome the effects of sleep inertia and allow for adequate briefing.
 - (6) If necessary, a flight crew member may take more than one rest period, if time permits, on longer sectors, subject to the restrictions above.
 - (7) Controlled rest periods should terminate at least 30 minutes before the top of descent.

CAT.OP.MPA.215 Use of headset — aeroplanes

- (a) Each flight crew member required to be on duty in the flight crew compartment shall wear a headset with boom microphone or equivalent. The headset shall be used as the primary device for voice communications with ATS:
- (1) when on the ground:
 - (i) when receiving the ATC departure clearance via voice communication; and
 - (ii) when engines are running;
 - (2) when in flight:
 - (i) below transition altitude; or
 - (ii) 10 000 ft, whichever is higher;and
 - (3) whenever deemed necessary by the commander.
- (b) In the conditions of (a), the boom microphone or equivalent shall be in a position that permits its use for two-way radio communications.

CAT.OP.MPA.216 Use of headset — helicopters

Each flight crew member required to be on duty in the flight crew compartment shall wear a headset with boom microphone, or equivalent, and use it as the primary device to communicate with ATS.

CAT.OP.MPA.220 Assisting means for emergency evacuation

The operator shall establish procedures to ensure that before taxiing, take-off and landing and when safe and practicable to do so, all means of assistance for emergency evacuation that deploy automatically are armed.

CAT.OP.MPA.225 Seats, safety belts and restraint systems

- (a) *Crew members*
- (1) During take-off and landing, and whenever decided by the commander in the interest of safety, each crew member shall be properly secured by all safety belts and restraint systems provided.
 - (2) During other phases of the flight, each flight crew member in the flight crew compartment shall keep the assigned station safety belt fastened while at his/her station.
- (b) *Passengers*
- (1) Before take-off and landing, and during taxiing, and whenever deemed necessary in the interest of safety, the commander shall be satisfied that each passenger on board occupies a seat or berth with his/her safety belt or restraint system properly secured.
 - (2) The operator shall make provisions for multiple occupancy of aircraft seats that is only allowed on specified seats. The commander shall be satisfied that multiple occupancy does not occur other than by one adult and one infant who is properly secured by a supplementary loop belt or other restraint device.

CAT.OP.MPA.230 Securing of passenger compartment and galley(s)

- (a) The operator shall establish procedures to ensure that before taxiing, take-off and landing all exits and escape paths are unobstructed.
- (b) The commander shall ensure that before take-off and landing, and whenever deemed necessary in the interest of safety, all equipment and baggage are properly secured.

CAT.OP.MPA.235 Life-jackets — helicopters

The operator shall establish procedures to ensure that, when operating a helicopter over water in performance class 3, account is taken of the duration of the flight and conditions to be encountered when deciding if life-jackets are to be worn by all occupants.

CAT.OP.MPA.240 Smoking on board

The commander shall not allow smoking on board:

- (a) whenever considered necessary in the interest of safety;
- (b) during refuelling and defuelling of the aircraft;
- (c) while the aircraft is on the surface unless the operator has determined procedures to mitigate the risks during ground operations;
- (d) outside designated smoking areas, in the aisle(s) and lavatory(ies);
- (e) in cargo compartments and/or other areas where cargo is carried that is not stored in flame-resistant containers or covered by flame-resistant canvas; and
- (f) in those areas of the passenger compartment where oxygen is being supplied.

CAT.OP.MPA.245 Meteorological conditions — all aircraft

- (a) On IFR flights the commander shall only:
 - (1) commence take-off; or
 - (2) continue beyond the point from which a revised ATS flight plan applies in the event of in-flight replanning,when information is available indicating that the expected weather conditions, at the time of arrival, at the destination and/or required alternate aerodrome(s) are at or above the planning minima.
- (b) On IFR flights, the commander shall only continue towards the planned destination aerodrome when the latest information available indicates that, at the expected time of arrival, the weather conditions at the destination, or at least one destination alternate aerodrome, are at or above the applicable aerodrome operating minima.
- (c) On VFR flights, the commander shall only commence take-off when the appropriate weather reports and/or forecasts indicate that the meteorological conditions along the part of the route to be flown under VFR will, at the appropriate time, be at or above the VFR limits.

CAT.OP.MPA.246 Meteorological conditions — aeroplanes

In addition to CAT.OP.MPA.245, on IFR flights with aeroplanes, the commander shall only continue beyond:

- (a) the decision point when using the reduced contingency fuel (RCF) procedure; or
- (b) the pre-determined point when using the pre-determined point (PDP) procedure,
- when information is available indicating that the expected weather conditions, at the time of arrival, at the destination and/or required alternate aerodrome(s) are at or above the applicable aerodrome operating minima.

CAT.OP.MPA.247 Meteorological conditions — helicopters

In addition to CAT.OP.MPA.245:

- (a) On VFR flights overwater out of sight of land with helicopters, the commander shall only commence take-off when the appropriate weather reports and/or forecasts indicate that the cloud ceiling will be above 600 ft by day or 1 200 ft by night.
- (b) Notwithstanding (a), when flying between helidecks located in class G airspace where the overwater sector is less than 10 NM, VFR flights may be conducted when the limits are at, or better than, the following:

Table 1

Minima for flying between helidecks located in class G airspace

	Day		Night	
	Height ^(*)	Visibility	Height ^(*)	Visibility
Single-pilot	300 ft	3 km	500 ft	5 km
Two pilots	300 ft	2 km ^(**)	500 ft	5 km ^(***)

- (*) The cloud base shall be such as to allow flight at the specified height, below and clear of cloud.
- (**) Helicopters may be operated in flight visibility down to 800 m provided the destination or an intermediate structure is continuously visible.
- (***) Helicopters may be operated in flight visibility down to 1500 m provided the destination or an intermediate structure is continuously visible.
- (c) Flight with helicopters to a helideck or elevated FATO shall only be operated when the mean wind speed at the helideck or elevated FATO is reported to be less than 60 kt.

Grey text shall be applicable until 1 July 2018, then deleted

CAT.OP.MPA.250 Ice and other contaminants — ground procedures

- (a) The operator shall establish procedures to be followed when ground de-icing and anti-icing and related inspections of the aircraft are necessary to allow the safe operation of the aircraft.
- (b) The commander shall only commence take-off if the aircraft is clear of any deposit that might adversely affect the performance or controllability of the aircraft, except as permitted under (a) and in accordance with the AFM.

GM1 CAT.OP.MPA.250 Ice and other contaminants — ground procedures

TERMINOLOGY

Terms used in the context of de-icing/anti-icing have the meaning defined in the following subparagraphs.

- (a) 'Anti-icing fluid' includes, but is not limited to, the following:
 - (1) Type I fluid if heated to minimum 60°C at the nozzle;
 - (2) mixture of water and Type I fluid if heated to minimum 60°C at the nozzle;
 - (3) Type II fluid;
 - (4) mixture of water and Type II fluid;
 - (5) Type III fluid;
 - (6) mixture of water and Type III fluid;
 - (7) Type IV fluid;
 - (8) mixture of water and Type IV fluid.

On uncontaminated aircraft surfaces, Type II, III and IV anti-icing fluids are normally applied unheated.
- (b) 'Clear ice': a coating of ice, generally clear and smooth, but with some air pockets. It forms on exposed objects, the temperatures of which are at, below or slightly above the freezing temperature, by the freezing of super-cooled drizzle, droplets or raindrops.
- (c) Conditions conducive to aircraft icing on the ground (e.g. freezing fog, freezing precipitation, frost, rain or high humidity (on cold soaked wings), snow or mixed rain and snow).
- (d) 'Contamination', in this context, is understood as being all forms of frozen or semi-frozen moisture, such as frost, snow, slush or ice.
- (e) 'Contamination check': a check of aircraft for contamination to establish the need for de-icing.
- (f) 'De-icing fluid': such fluid includes, but is not limited to, the following:
 - (1) heated water;
 - (2) Type I fluid;
 - (3) mixture of water and Type I fluid;
 - (4) Type II fluid;
 - (5) mixture of water and Type II fluid;
 - (6) Type III fluid;
 - (7) mixture of water and Type III fluid;

- (8) Type IV fluid;
- (9) mixture of water and Type IV fluid.

De-icing fluid is normally applied heated to ensure maximum efficiency.

- (g) ‘De-icing/anti-icing’: this is the combination of de-icing and anti-icing performed in either one or two steps.
- (h) ‘Ground ice detection system (GIDS)’: system used during aircraft ground operations to inform the personnel involved in the operation and/or the flight crew about the presence of frost, ice, snow or slush on the aircraft surfaces.
- (i) ‘Lowest operational use temperature (LOUT)’: the lowest temperature at which a fluid has been tested and certified as acceptable in accordance with the appropriate aerodynamic acceptance test whilst still maintaining a freezing point buffer of not less than:
 - (1) 10°C for a Type I de-icing/anti-icing fluid; or
 - (2) 7°C for Type II, III or IV de-icing/anti-icing fluids.
- (j) ‘Post-treatment check’: an external check of the aircraft after de-icing and/or anti-icing treatment accomplished from suitably elevated observation points (e.g. from the de-icing/anti-icing equipment itself or other elevated equipment) to ensure that the aircraft is free from any frost, ice, snow, or slush.
- (k) ‘Pre-take-off check’: an assessment normally performed by the flight crew, to validate the applied HoT.
- (l) ‘Pre-take-off contamination check’: a check of the treated surfaces for contamination, performed when the HoT has been exceeded or if any doubt exists regarding the continued effectiveness of the applied anti-icing treatment. It is normally accomplished externally, just before commencement of the take-off run.

ANTI-ICING CODES

- (m) The following are examples of anti-icing codes:
 - (1) ‘Type I’ at (start time) — to be used if anti-icing treatment has been performed with a Type I fluid;
 - (2) ‘Type II/100’ at (start time) — to be used if anti-icing treatment has been performed with undiluted Type II fluid;
 - (3) ‘Type II/75’ at (start time) — to be used if anti-icing treatment has been performed with a mixture of 75 % Type II fluid and 25 % water;
 - (4) ‘Type IV/50’ at (start time) — to be used if anti-icing treatment has been performed with a mixture of 50 % Type IV fluid and 50 % water.
- (n) When a two-step de-icing/anti-icing operation has been carried out, the anti-icing code should be determined by the second step fluid. Fluid brand names may be included, if desired.

GM2 CAT.OP.MPA.250 Ice and other contaminants — ground procedures

DE-ICING/ANTI-ICING — PROCEDURES

- (a) De-icing and/or anti-icing procedures should take into account manufacturer’s recommendations, including those that are type-specific and cover:

- (1) contamination checks, including detection of clear ice and under-wing frost; limits on the thickness/area of contamination published in the AFM or other manufacturers' documentation should be followed;
 - (2) procedures to be followed if de-icing and/or anti-icing procedures are interrupted or unsuccessful;
 - (3) post-treatment checks;
 - (4) pre-take-off checks;
 - (5) pre-take-off contamination checks;
 - (6) the recording of any incidents relating to de-icing and/or anti-icing; and
 - (7) the responsibilities of all personnel involved in de-icing and/or anti-icing.
- (b) Operator's procedures should ensure the following:
- (1) When aircraft surfaces are contaminated by ice, frost, slush or snow, they are de-iced prior to take-off according to the prevailing conditions. Removal of contaminants may be performed with mechanical tools, fluids (including hot water), infrared heat or forced air, taking account of aircraft type-specific provisions.
 - (2) Account is taken of the wing skin temperature versus outside air temperature (OAT), as this may affect:
 - (i) the need to carry out aircraft de-icing and/or anti-icing; and/or
 - (ii) the performance of the de-icing/anti-icing fluids.
 - (3) When freezing precipitation occurs or there is a risk of freezing precipitation occurring that would contaminate the surfaces at the time of take-off, aircraft surfaces should be anti-iced. If both de-icing and anti-icing are required, the procedure may be performed in a one- or two-step process, depending upon weather conditions, available equipment, available fluids and the desired hold-over time (HoT). One-step de-icing/anti-icing means that de-icing and anti-icing are carried out at the same time, using a mixture of de-icing/anti-icing fluid and water. Two-step de-icing/anti-icing means that de-icing and anti-icing are carried out in two separate steps. The aircraft is first de-iced using heated water only or a heated mixture of de-icing/anti-icing fluid and water. After completion of the de-icing operation, a layer of a mixture of de-icing/anti-icing fluid and water, or of de-icing/anti-icing fluid only, is sprayed over the aircraft surfaces. The second step will be taken before the first-step fluid freezes, typically within three minutes and, if necessary, area by area.
 - (4) When an aircraft is anti-iced and a longer HoT is needed/desired, the use of a less diluted Type II or Type IV fluid should be considered.
 - (5) All restrictions relative to OAT and fluid application (including, but not necessarily limited to, temperature and pressure) published by the fluid manufacturer and/or aircraft manufacturer, are followed. and procedures, limitations and recommendations to prevent the formation of fluid residues are followed.
 - (6) During conditions conducive to aircraft icing on the ground or after de-icing and/or anti-icing, an aircraft is not dispatched for departure unless it has been given a contamination check or a post-treatment check by a trained and qualified person. This check should cover all treated surfaces of the aircraft and be performed from points offering sufficient accessibility to these parts. To ensure that there is no clear ice on suspect areas, it may be necessary to make a physical check (e.g. tactile).
 - (7) The required entry is made in the technical log.

- (8) The commander continually monitors the environmental situation after the performed treatment. Prior to take-off, he/she performs a pre-take-off check, which is an assessment of whether the applied HoT is still appropriate. This pre-take-off check includes, but is not limited to, factors such as precipitation, wind and OAT.
 - (9) If any doubt exists as to whether a deposit may adversely affect the aircraft's performance and/or controllability characteristics, the commander should arrange for a pre-take-off contamination check to be performed in order to verify that the aircraft's surfaces are free of contamination. Special methods and/or equipment may be necessary to perform this check, especially at night time or in extremely adverse weather conditions. If this check cannot be performed just before take-off, re-treatment should be applied.
 - (10) When re-treatment is necessary, any residue of the previous treatment should be removed and a completely new de-icing/anti-icing treatment should be applied.
 - (11) When a ground ice detection system (GIDS) is used to perform an aircraft surfaces check prior to and/or after a treatment, the use of GIDS by suitably trained personnel should be part of the procedure.
- (c) Special operational considerations
- (1) When using thickened de-icing/anti-icing fluids, the operator should consider a two-step de-icing/anti-icing procedure, the first step preferably with hot water and/or un-thickened fluids.
 - (2) The use of de-icing/anti-icing fluids should be in accordance with the aircraft manufacturer's documentation. This is particularly important for thickened fluids to assure sufficient flow-off during take-off.
 - (3) The operator should comply with any type-specific operational provision(s), such as an aircraft mass decrease and/or a take-off speed increase associated with a fluid application.
 - (4) The operator should take into account any flight handling procedures (stick force, rotation speed and rate, take-off speed, aircraft attitude etc.) laid down by the aircraft manufacturer when associated with a fluid application.
 - (5) The limitations or handling procedures resulting from (c)(3) and/or (c)(4) above should be part of the flight crew pre take-off briefing.
- (d) Communications
- (1) Before aircraft treatment. When the aircraft is to be treated with the flight crew on board, the flight and personnel involved in the operation should confirm the fluid to be used, the extent of treatment required and any aircraft type-specific procedure(s) to be used. Any other information needed to apply the HoT tables should be exchanged.
 - (2) Anti-icing code. The operator's procedures should include an anti-icing code, which indicates the treatment the aircraft has received. This code provides the flight crew with the minimum details necessary to estimate a HoT and confirms that the aircraft is free of contamination.
 - (3) After treatment. Before reconfiguring or moving the aircraft, the flight crew should receive a confirmation from the personnel involved in the operation that all de-icing and/or anti-icing operations are complete and that all personnel and equipment are clear of the aircraft.
- (e) Hold-over protection
- The operator should publish in the operations manual, when required, the HoTs in the form of a table or a diagram, to account for the various types of ground icing conditions and the different

types and concentrations of fluids used. However, the times of protection shown in these tables are to be used as guidelines only and are normally used in conjunction with the pre-take-off check.

(f) Training

The operator's initial and recurrent de-icing and/or anti-icing training programmes (including communication training) for flight crew and those of its personnel involved in the operation who are involved in de-icing and/or anti-icing should include additional training if any of the following is introduced:

- (1) a new method, procedure and/or technique;
- (2) a new type of fluid and/or equipment; or
- (3) a new type of aircraft.

(g) Contracting

When the operator contracts training on de-icing/anti-icing, the operator should ensure that the contractor complies with the operator's training/qualification procedures, together with any specific procedures in respect of:

- (1) de-icing and/or anti-icing methods and procedures;
- (2) fluids to be used, including precautions for storage and preparation for use;
- (3) specific aircraft provisions (e.g. no-spray areas, propeller/engine de-icing, APU operation etc.); and
- (4) checking and communications procedures.

(h) Special maintenance considerations

(1) General

The operator should take proper account of the possible side-effects of fluid use. Such effects may include, but are not necessarily limited to, dried and/or re-hydrated residues, corrosion and the removal of lubricants.

(2) Special considerations regarding residues of dried fluids

The operator should establish procedures to prevent or detect and remove residues of dried fluid. If necessary the operator should establish appropriate inspection intervals based on the recommendations of the airframe manufacturers and/or the operator's own experience:

(i) Dried fluid residues

Dried fluid residues could occur when surfaces have been treated and the aircraft has not subsequently been flown and has not been subject to precipitation. The fluid may then have dried on the surfaces.

(ii) Re-hydrated fluid residues

Repetitive application of thickened de-icing/anti-icing fluids may lead to the subsequent formation/build-up of a dried residue in aerodynamically quiet areas, such as cavities and gaps. This residue may re-hydrate if exposed to high humidity conditions, precipitation, washing, etc., and increase to many times its original size/volume. This residue will freeze if exposed to conditions at or below 0 °C. This may cause moving parts, such as elevators, ailerons, and flap actuating mechanisms to stiffen or jam in-flight. Re-hydrated residues may also form on exterior surfaces, which can reduce lift, increase drag and stall speed. Re-hydrated residues may also

collect inside control surface structures and cause clogging of drain holes or imbalances to flight controls. Residues may also collect in hidden areas, such as around flight control hinges, pulleys, grommets, on cables and in gaps.

- (iii) Operators are strongly recommended to obtain information about the fluid dry-out and re-hydration characteristics from the fluid manufacturers and to select products with optimised characteristics.
- (iv) Additional information should be obtained from fluid manufacturers for handling, storage, application and testing of their products.

GM3 CAT.OP.MPA.250 Ice and other contaminants — ground procedures

DE-ICING/ANTI-ICING BACKGROUND INFORMATION

Further guidance material on this issue is given in the ICAO *Manual of Aircraft Ground De-icing/Anti-icing Operations* (Doc 9640) (hereinafter referred to as the ICAO *Manual of Aircraft Ground De-icing/Anti-icing Operations*).

(a) General

- (1) Any deposit of frost, ice, snow or slush on the external surfaces of an aircraft may drastically affect its flying qualities because of reduced aerodynamic lift, increased drag, modified stability and control characteristics. Furthermore, freezing deposits may cause moving parts, such as elevators, ailerons, flap actuating mechanism etc., to jam and create a potentially hazardous condition. Propeller/engine/auxiliary power unit (APU)/systems performance may deteriorate due to the presence of frozen contaminants on blades, intakes and components. Also, engine operation may be seriously affected by the ingestion of snow or ice, thereby causing engine stall or compressor damage. In addition, ice/frost may form on certain external surfaces (e.g. wing upper and lower surfaces, etc.) due to the effects of cold fuel/structures, even in ambient temperatures well above 0 °C.
- (2) Procedures established by the operator for de-icing and/or anti-icing are intended to ensure that the aircraft is clear of contamination so that degradation of aerodynamic characteristics or mechanical interference will not occur and, following anti-icing, to maintain the airframe in that condition during the appropriate HoT.
- (3) Under certain meteorological conditions, de-icing and/or anti-icing procedures may be ineffective in providing sufficient protection for continued operations. Examples of these conditions are freezing rain, ice pellets and hail, heavy snow, high wind velocity, fast dropping OAT or any time when freezing precipitation with high water content is present. No HoT guidelines exist for these conditions.
- (4) Material for establishing operational procedures can be found, for example, in:
 - (i) ICAO Annex 3, Meteorological Service for International Air Navigation;
 - (ii) ICAO Manual of Aircraft Ground De-icing/Anti-icing Operations;
 - (iii) ISO 11075 Aircraft - De-icing/anti-icing fluids - ISO type I;
 - (iv) ISO 11076 Aircraft - De-icing/anti-icing methods with fluids;
 - (v) ISO 11077 Aerospace - Self propelled de-icing/anti-icing vehicles - Functional requirements;
 - (vi) ISO 11078 Aircraft - De-icing/anti-icing fluids -- ISO types II, III and IV;
 - (vii) AEA 'Recommendations for de-icing/anti-icing of aircraft on the ground';

- (viii) AEA 'Training recommendations and background information for de-icing/anti-icing of aircraft on the ground';
- (ix) EUROCAE ED-104A Minimum Operational Performance Specification for Ground Ice Detection Systems;
- (x) SAE AS5681 Minimum Operational Performance Specification for Remote On-Ground Ice Detection Systems;
- (xi) SAE ARP4737 Aircraft - De-icing/anti-icing methods;
- (xii) SAE AMS1424 De-icing/anti-icing Fluid, Aircraft, SAE Type I;
- (xiii) SAE AMS1428 Fluid, Aircraft De-icing/anti-icing, Non-Newtonian, (Pseudoplastic), SAE Types II, III, and IV;
- (xiv) SAE ARP1971 Aircraft De-icing Vehicle - Self-Propelled, Large and Small Capacity;
- (xv) SAE ARP5149 Training Programme Guidelines for De-icing/anti-icing of Aircraft on Ground; and
- (xvi) SAE ARP5646 Quality Program Guidelines for De-icing/anti-icing of Aircraft on the Ground.

(b) Fluids

- (1) Type I fluid: Due to its properties, Type I fluid forms a thin, liquid-wetting film on surfaces to which it is applied which, under certain weather conditions, gives a very limited HoT. With this type of fluid, increasing the concentration of fluid in the fluid/water mix does not provide any extension in HoT.
- (2) Type II and Type IV fluids contain thickeners which enable the fluid to form a thicker liquid-wetting film on surfaces to which it is applied. Generally, this fluid provides a longer HoT than Type I fluids in similar conditions. With this type of fluid, the HoT can be extended by increasing the ratio of fluid in the fluid/water mix.
- (3) Type III fluid is a thickened fluid especially intended for use on aircraft with low rotation speeds.
- (4) Fluids used for de-icing and/or anti-icing should be acceptable to the operator and the aircraft manufacturer. These fluids normally conform to specifications such as SAE AMS1424, SAE AMS1428 or equivalent. Use of non-conforming fluids is not recommended due to their characteristics being unknown. The anti-icing and aerodynamic properties of thickened fluids may be seriously degraded by, for example, inappropriate storage, treatment, application, application equipment and age.

(c) Hold-over protection

- (1) Hold-over protection is achieved by a layer of anti-icing fluid remaining on and protecting aircraft surfaces for a period of time. With an one-step de-icing/anti-icing procedure, the HoT begins at the commencement of de-icing/anti-icing. With a two-step procedure, the HoT begins at the commencement of the second (anti-icing) step. The hold-over protection runs out:
 - (i) at the commencement of the take-off roll (due to aerodynamic shedding of fluid); or
 - (ii) when frozen deposits start to form or accumulate on treated aircraft surfaces, thereby indicating the loss of effectiveness of the fluid.

-
- (2) The duration of hold-over protection may vary depending on the influence of factors other than those specified in the HoT tables. Guidance should be provided by the operator to take account of such factors, which may include:
 - (i) atmospheric conditions, e.g. exact type and rate of precipitation, wind direction and velocity, relative humidity and solar radiation; and
 - (ii) the aircraft and its surroundings, such as aircraft component inclination angle, contour and surface roughness, surface temperature, operation in close proximity to other aircraft (jet or propeller blast) and ground equipment and structures.
 - (3) HoTs are not meant to imply that flight is safe in the prevailing conditions if the specified HoT has not been exceeded. Certain meteorological conditions, such as freezing drizzle or freezing rain, may be beyond the certification envelope of the aircraft.
 - (4) References to usable HoT tables may be found in the AEA 'Recommendations for de-icing/anti-icing of aircraft on the ground'.

CAT.OP.MPA.255 Ice and other contaminants — flight procedures

- (a) The operator shall establish procedures for flights in expected or actual icing conditions.
- (b) The commander shall only commence a flight or intentionally fly into expected or actual icing conditions if the aircraft is certified and equipped to cope with such conditions.
- (c) If icing exceeds the intensity of icing for which the aircraft is certified or if an aircraft not certified for flight in known icing conditions encounters icing, the commander shall exit the icing conditions without delay, by a change of level and/or route, if necessary by declaring an emergency to ATC.

AMC1 CAT.OP.MPA.255 Ice and other contaminants — flight procedures

FLIGHT IN EXPECTED OR ACTUAL ICING CONDITIONS — AEROPLANES

- (a) In accordance with Article 2(a)5. of Annex IV to Regulation (EC) No 216/2008 (Essential requirements for air operations), in case of flight into known or expected icing conditions, the aircraft must be certified, equipped and/or treated to operate safely in such conditions. The procedures to be established by the operator should take account of the design, the equipment, the configuration of the aircraft and the necessary training. For these reasons, different aircraft types operated by the same company may require the development of different procedures. In every case, the relevant limitations are those which are defined in the AFM and other documents produced by the manufacturer.
- (b) The operator should ensure that the procedures take account of the following:
 - (1) the equipment and instruments which must be serviceable for flight in icing conditions;
 - (2) the limitations on flight in icing conditions for each phase of flight. These limitations may be imposed by the aircraft's de-icing or anti-icing equipment or the necessary performance corrections that have to be made;
 - (3) the criteria the flight crew should use to assess the effect of icing on the performance and/or controllability of the aircraft;
 - (4) the means by which the flight crew detects, by visual cues or the use of the aircraft's ice detection system, that the flight is entering icing conditions; and
 - (5) the action to be taken by the flight crew in a deteriorating situation (which may develop rapidly) resulting in an adverse effect on the performance and/or controllability of the aircraft, due to:
 - (i) the failure of the aircraft's anti-icing or de-icing equipment to control a build-up of ice; and/or
 - (ii) ice build-up on unprotected areas.
- (c) Training for dispatch and flight in expected or actual icing conditions. The content of the operations manual should reflect the training, both conversion and recurrent, which flight crew, cabin crew and all other relevant operational personnel require in order to comply with the procedures for dispatch and flight in icing conditions:
 - (1) For the flight crew, the training should include:
 - (i) instruction on how to recognise, from weather reports or forecasts which are available before flight commences or during flight, the risks of encountering icing conditions along the planned route and on how to modify, as necessary, the departure and in-flight routes or profiles;

- (ii) instruction on the operational and performance limitations or margins;
 - (iii) the use of in-flight ice detection, anti-icing and de-icing systems in both normal and abnormal operation; and
 - (iv) instruction on the differing intensities and forms of ice accretion and the consequent action which should be taken.
- (2) For the cabin crew, the training should include:
- (i) awareness of the conditions likely to produce surface contamination; and
 - (ii) the need to inform the flight crew of significant ice accretion.

AMC2 CAT.OP.MPA.255 Ice and other contaminants — flight procedures

FLIGHT IN EXPECTED OR ACTUAL ICING CONDITIONS — HELICOPTERS

- (a) The procedures to be established by the operator should take account of the design, the equipment and the configuration of the helicopter and also of the training which is needed. For these reasons, different helicopter types operated by the same company may require the development of different procedures. In every case, the relevant limitations are those that are defined in the AFM and other documents produced by the manufacturer.
- (b) For the required entries in the operations manual, the procedural principles that apply to flight in icing conditions are referred to under Subpart MLR of Annex III (ORO.MLR) and should be cross-referenced, where necessary, to supplementary, type-specific data.
- (c) Technical content of the procedures

The operator should ensure that the procedures take account of the following:

- (1) CAT.IDE.H.165;
 - (2) the equipment and instruments that should be serviceable for flight in icing conditions;
 - (3) the limitations on flight in icing conditions for each phase of flight. These limitations may be specified by the helicopter's de-icing or anti-icing equipment or the necessary performance corrections which have to be made;
 - (4) the criteria the flight crew should use to assess the effect of icing on the performance and/or controllability of the helicopter;
 - (5) the means by which the flight crew detects, by visual cues or the use of the helicopter's ice detection system, that the flight is entering icing conditions; and
 - (6) the action to be taken by the flight crew in a deteriorating situation (which may develop rapidly) resulting in an adverse effect on the performance and/or controllability of the helicopter, due to either:
 - (i) the failure of the helicopter's anti-icing or de-icing equipment to control a build-up of ice; and/or
 - (ii) ice build-up on unprotected areas.
- (d) Training for dispatch and flight in expected or actual icing conditions
- The content of the operations manual, Part D, should reflect the training, both conversion and recurrent, which flight crew, and all other relevant operational personnel will require in order to comply with the procedures for dispatch and flight in icing conditions.
- (1) For the flight crew, the training should include:

-
- (i) instruction on how to recognise, from weather reports or forecasts that are available before flight commences or during flight, the risks of encountering icing conditions along the planned route and on how to modify, as necessary, the departure and in-flight routes or profiles;
 - (ii) instruction on the operational and performance limitations or margins;
 - (iii) the use of in-flight ice detection, anti-icing and de-icing systems in both normal and abnormal operation; and
 - (iv) instruction on the differing intensities and forms of ice accretion and the consequent action which should be taken.
- (2) For crew members other than flight crew, the training should include;
- (i) awareness of the conditions likely to produce surface contamination; and
 - (ii) the need to inform the flight crew of significant ice accretion.

CAT.OP.MPA.260 Fuel and oil supply

The commander shall only commence a flight or continue in the event of in-flight replanning when satisfied that the aircraft carries at least the planned amount of usable fuel and oil to complete the flight safely, taking into account the expected operating conditions.

CAT.OP.MPA.265 Take-off conditions

Before commencing take-off, the commander shall be satisfied that:

- (a) according to the information available to him/her, the weather at the aerodrome or operating site and the condition of the runway or FATO intended to be used would not prevent a safe take-off and departure; and
- (b) established aerodrome operating minima will be complied with.

CAT.OP.MPA.270 Minimum flight altitudes

The commander or the pilot to whom conduct of the flight has been delegated shall not fly below specified minimum altitudes except when:

- (a) necessary for take-off or landing; or
- (b) descending in accordance with procedures approved by the competent authority.

CAT.OP.MPA.275 Simulated abnormal situations in flight

The operator shall ensure that when carrying passengers or cargo the following are not simulated:

- (a) abnormal or emergency situations that require the application of abnormal or emergency procedures; or
- (b) flight in IMC by artificial means.

CAT.OP.MPA.280 In-flight fuel management — aeroplanes

The operator shall establish a procedure to ensure that in-flight fuel checks and fuel management are carried out according to the following criteria.

(a) In-flight fuel checks

- (1) The commander shall ensure that fuel checks are carried out in-flight at regular intervals. The usable remaining fuel shall be recorded and evaluated to:
 - (i) compare actual consumption with planned consumption;
 - (ii) check that the usable remaining fuel is sufficient to complete the flight, in accordance with (b); and
 - (iii) determine the expected usable fuel remaining on arrival at the destination aerodrome.
- (2) The relevant fuel data shall be recorded.

(b) In-flight fuel management

- (1) The flight shall be conducted so that the expected usable fuel remaining on arrival at the destination aerodrome is not less than:
 - (i) the required alternate fuel plus final reserve fuel; or

- (ii) the final reserve fuel if no alternate aerodrome is required.
- (2) If an in-flight fuel check shows that the expected usable fuel remaining on arrival at the destination aerodrome is less than:
 - (i) the required alternate fuel plus final reserve fuel, the commander shall take into account the traffic and the operational conditions prevailing at the destination aerodrome, at the destination alternate aerodrome and at any other adequate aerodrome in deciding whether to proceed to the destination aerodrome or to divert so as to perform a safe landing with not less than final reserve fuel; or
 - (ii) the final reserve fuel if no alternate aerodrome is required, the commander shall take appropriate action and proceed to an adequate aerodrome so as to perform a safe landing with not less than final reserve fuel.
- (3) The commander shall declare an emergency when the calculated usable fuel on landing, at the nearest adequate aerodrome where a safe landing can be performed, is less than final reserve fuel.
- (4) Additional conditions for specific procedures
 - (i) On a flight using the RCF procedure, to proceed to the destination 1 aerodrome, the commander shall ensure that the usable fuel remaining at the decision point is at least the total of:
 - (A) trip fuel from the decision point to the destination 1 aerodrome;
 - (B) contingency fuel equal to 5 % of trip fuel from the decision point to the destination 1 aerodrome;
 - (C) destination 1 aerodrome alternate fuel, if a destination 1 alternate aerodrome is required; and
 - (D) final reserve fuel.
 - (ii) On a flight using the PDP procedure to proceed to the destination aerodrome, the commander shall ensure that the usable fuel remaining at the PDP is at least the total of:
 - (A) trip fuel from the PDP to the destination aerodrome;
 - (B) contingency fuel from the PDP to the destination aerodrome; and
 - (C) additional fuel.

CAT.OP.MPA.281 In-flight fuel management — helicopters

- (a) The operator shall establish a procedure to ensure that in-flight fuel checks and fuel management are carried out.
- (b) The commander shall ensure that the amount of usable fuel remaining in flight is not less than the fuel required to proceed to an aerodrome or operating site where a safe landing can be made, with final reserve fuel remaining.
- (c) The commander shall declare an emergency when the actual usable fuel on board is less than final reserve fuel.

AMC1 CAT.OP.MPA.281 In-flight fuel management — helicopters**COMPLEX MOTOR-POWERED HELICOPTERS, OTHER THAN LOCAL OPERATIONS**

The operator should base in-flight fuel management procedures on the following criteria:

(a) In-flight fuel checks

(1) The commander should ensure that fuel checks are carried out in-flight at regular intervals. The remaining fuel should be recorded and evaluated to:

- (i) compare actual consumption with planned consumption;
- (ii) check that the remaining fuel is sufficient to complete the flight; and
- (iii) determine the expected fuel remaining on arrival at the destination.

(2) The relevant fuel data should be recorded.

(b) In-flight fuel management

(1) If, as a result of an in-flight fuel check, the expected fuel remaining on arrival at the destination is less than the required alternate fuel plus final reserve fuel, the commander should:

- (i) divert; or
- (ii) replan the flight in accordance with CAT.OP.MPA.181 (d)(1) unless he/she considers it safer to continue to the destination.

Applicable until 01 July 2018, then replaced by paragraph (ii) below.

Applicable from 01 July 2018. Will replace paragraph (ii) above.

- (ii) replan the flight in accordance with SPA.HOFO.120 unless he/she considers it safer to continue to the destination.

(2) At an onshore destination, when two suitable, separate touchdown and lift-off areas are available and the weather conditions at the destination comply with those specified for planning in CAT.OP.MPA.245 (a)(2), the commander may permit alternate fuel to be used before landing at the destination.

(c) If, as a result of an in-flight fuel check on a flight to an isolated destination, planned in accordance with (b), the expected fuel remaining at the point of last possible diversion is less than the sum of:

- (1) fuel to divert to an operating site selected in accordance with CAT.OP.MPA.181 (a);
- (2) contingency fuel; and
- (3) final reserve fuel,

the commander should:

- (i) divert; or
- (ii) proceed to the destination provided that at onshore destinations, two suitable, separate touchdown and lift-off areas are available at the destination and the expected weather conditions at the destination comply with those specified for planning in CAT.OP.MPA.245 (a)(2).

CAT.OP.MPA.285 Use of supplemental oxygen

The commander shall ensure that flight crew members engaged in performing duties essential to the safe operation of an aircraft in flight use supplemental oxygen continuously whenever the cabin altitude exceeds 10 000 ft for a period of more than 30 minutes and whenever the cabin altitude exceeds 13 000 ft.

CAT.OP.MPA.290 Ground proximity detection

When undue proximity to the ground is detected by a flight crew member or by a ground proximity warning system, the pilot flying shall take corrective action immediately to establish safe flight conditions.

GM1 CAT.OP.MPA.290 Ground proximity detection**TERRAIN AWARENESS WARNING SYSTEM (TAWS) FLIGHT CREW TRAINING PROGRAMMES****(a) Introduction**

- (1) This GM contains performance-based training objectives for TAWS flight crew training.
- (2) The training objectives cover five areas: theory of operation; pre-flight operations; general in-flight operations; response to TAWS cautions; and response to TAWS warnings.
- (3) The term 'TAWS' in this GM means a ground proximity warning system (GPWS) enhanced by a forward-looking terrain avoidance function. Alerts include both cautions and warnings.
- (4) The content of this GM is intended to assist operators who are producing training programmes. The information it contains has not been tailored to any specific aircraft or TAWS equipment, but highlights features which are typically available where such systems are installed. It is the responsibility of the individual operator to determine the applicability of the content of this guidance material to each aircraft and TAWS equipment installed and their operation. Operators should refer to the AFM and/or aircraft/flight crew operating manual (A/FCOM), or similar documents, for information applicable to specific configurations. If there should be any conflict between the content of this guidance material and that published in the other documents described above, then information contained in the AFM or A/FCOM will take precedence.

(b) Scope

- (1) The scope of this GM is designed to identify training objectives in the areas of: academic training; manoeuvre training; initial evaluation; and recurrent qualification. Under each of these four areas, the training material has been separated into those items which are considered essential training items and those that are considered to be desirable. In each area, objectives and acceptable performance criteria are defined.
- (2) No attempt is made to define how the training programme should be implemented. Instead, objectives are established to define the knowledge that a pilot operating a TAWS is expected to possess and the performance expected from a pilot who has completed TAWS training. However, the guidelines do indicate those areas in which the pilot receiving the training should demonstrate his/her understanding, or performance, using a real-time, interactive training device, i.e. a flight simulator. Where appropriate, notes are included within the performance criteria which amplify or clarify the material addressed by the training objective.

(c) Performance-based training objectives

- (1) TAWS academic training
 - (i) This training is typically conducted in a classroom environment. The knowledge demonstrations specified in this section may be completed through the successful completion of written tests or by providing correct responses to non-real-time computer-based training (CBT) questions.
 - (ii) Theory of operation. The pilot should demonstrate an understanding of TAWS operation and the criteria used for issuing cautions and warnings. This training should address system operation. Objective: To demonstrate knowledge of how a TAWS functions. Criteria: The pilot should demonstrate an understanding of the following functions:
 - (A) Surveillance
 - (a) The GPWS computer processes data supplied from an air data computer, a radio altimeter, an instrument landing system (ILS)/microwave landing system (MLS)/multi-mode (MM) receiver, a roll attitude sensor, and actual position of the surfaces and of the landing gear.
 - (b) The forward-looking terrain avoidance function utilises an accurate source of known aircraft position, such as that which may be provided by a flight management system (FMS) or GPS, or an electronic terrain database. The source and scope of the terrain, obstacle and airport data, and features such as the terrain clearance floor, the runway picker, and geometric altitude (where provided) should all be described.
 - (c) Displays required to deliver TAWS outputs include a loudspeaker for voice announcements, visual alerts (typically amber and red lights), and a terrain awareness display (that may be combined with other displays). In addition, means should be provided for indicating the status of the TAWS and any partial or total failures that may occur.
 - (B) Terrain avoidance. Outputs from the TAWS computer provides visual and audio synthetic voice cautions and warnings to alert the flight crew about potential conflicts with terrain and obstacles.
 - (C) Alert thresholds. Objective: To demonstrate knowledge of the criteria for issuing cautions and warnings. Criteria: The pilot should be able to demonstrate an understanding of the methodology used by a TAWS to issue cautions and alerts and the general criteria for the issuance of these alerts, including:
 - (a) basic GPWS alerting modes specified in the ICAO Standard:
 - Mode 1: excessive sink rate;
 - Mode 2: excessive terrain closure rate;
 - Mode 3: descent after take-off or go-around;
 - Mode 4: unsafe proximity to terrain;
 - Mode 5: descent below ILS glide slope (caution only); and
 - (b) an additional, optional alert mode — Mode 6: radio altitude call-out (information only); TAWS cautions and warnings which alert the flight crew to obstacles and terrain ahead of the aircraft in line with or

adjacent to its projected flight path (forward-looking terrain avoidance (FLTA) and premature descent alert (PDA) functions).

- (D) TAWS limitations. Objective: To verify that the pilot is aware of the limitations of TAWS. Criteria: The pilot should demonstrate knowledge and an understanding of TAWS limitations identified by the manufacturer for the equipment model installed, such as:
- (a) navigation should not be predicated on the use of the terrain display;
 - (b) unless geometric altitude data are provided, use of predictive TAWS functions is prohibited when altimeter subscale settings display 'QFE';
 - (c) nuisance alerts can be issued if the aerodrome of intended landing is not included in the TAWS airport database;
 - (d) in cold weather operations, corrective procedures should be implemented by the pilot unless the TAWS has in-built compensation, such as geometric altitude data;
 - (e) loss of input data to the TAWS computer could result in partial or total loss of functionality. Where means exist to inform the flight crew that functionality has been degraded, this should be known and the consequences understood;
 - (f) radio signals not associated with the intended flight profile (e.g. ILS glide path transmissions from an adjacent runway) may cause false alerts;
 - (g) inaccurate or low accuracy aircraft position data could lead to false or non-annunciation of terrain or obstacles ahead of the aircraft; and
 - (h) minimum equipment list (MEL) restrictions should be applied in the event of the TAWS becoming partially or completely unserviceable. (It should be noted that basic GPWS has no forward-looking capability.)
- (E) TAWS inhibits. Objective: To verify that the pilot is aware of the conditions under which certain functions of a TAWS are inhibited. Criteria: The pilot should demonstrate knowledge and an understanding of the various TAWS inhibits, including the following means of:
- (a) silencing voice alerts;
 - (b) inhibiting ILS glide path signals (as may be required when executing an ILS back beam approach);
 - (c) inhibiting flap position sensors (as may be required when executing an approach with the flaps not in a normal position for landing);
 - (d) inhibiting the FLTA and PDA functions; and
 - (e) selecting or deselecting the display of terrain information, together with appropriate annunciation of the status of each selection.
- (2) Operating procedures. The pilot should demonstrate the knowledge required to operate TAWS avionics and to interpret the information presented by a TAWS. This training should address the following topics:
- (i) Use of controls. Objective: To verify that the pilot can properly operate all TAWS controls and inhibits. Criteria: The pilot should demonstrate the proper use of controls, including the following means by which:

- (A) before flight, any equipment self-test functions can be initiated;
 - (B) TAWS information can be selected for display; and
 - (C) all TAWS inhibits can be operated and what the consequent annunciations mean with regard to loss of functionality.
- (ii) Display interpretation. Objective: To verify that the pilot understands the meaning of all information that can be annunciated or displayed by a TAWS. Criteria: The pilot should demonstrate the ability to properly interpret information annunciated or displayed by a TAWS, including the following:
- (A) knowledge of all visual and aural indications that may be seen or heard;
 - (B) response required on receipt of a caution;
 - (C) response required on receipt of a warning; and
 - (D) response required on receipt of a notification that partial or total failure of the TAWS has occurred (including annunciation that the present aircraft position is of low accuracy).
- (iii) Use of basic GPWS or use of the FLTA function only. Objective: To verify that the pilot understands what functionality will remain following loss of the GPWS or of the FLTA function. Criteria: The pilot should demonstrate knowledge of how to recognise the following:
- (A) un-commanded loss of the GPWS function, or how to isolate this function and how to recognise the level of the remaining controlled flight into terrain (CFIT) protection (essentially, this is the FLTA function); and
 - (B) un-commanded loss of the FLTA function, or how to isolate this function and how to recognise the level of the remaining CFIT protection (essentially, this is the basic GPWS).
- (iv) Crew coordination. Objective: To verify that the pilot adequately briefs other flight crew members on how TAWS alerts will be handled. Criteria: The pilot should demonstrate that the pre-flight briefing addresses procedures that will be used in preparation for responding to TAWS cautions and warnings, including the following:
- (A) the action to be taken, and by whom, in the event that a TAWS caution and/or warning is issued; and
 - (B) how multi-function displays will be used to depict TAWS information at take-off, in the cruise and for the descent, approach, landing (and any go-around). This will be in accordance with procedures specified by the operator, who will recognise that it may be more desirable that other data are displayed at certain phases of flight and that the terrain display has an automatic 'pop-up' mode in the event that an alert is issued.
- (v) Reporting rules. Objective: To verify that the pilot is aware of the rules for reporting alerts to the controller and other authorities. Criteria: The pilot should demonstrate knowledge of the following:
- (A) when, following recovery from a TAWS alert or caution, a transmission of information should be made to the appropriate ATC unit; and
 - (B) the type of written report that is required, how it is to be compiled, and whether any cross reference should be made in the aircraft technical log and/or voyage report (in accordance with procedures specified by the

operator), following a flight in which the aircraft flight path has been modified in response to a TAWS alert, or if any part of the equipment appears not to have functioned correctly.

- (vi) Alert thresholds. Objective: To demonstrate knowledge of the criteria for issuing cautions and warnings. Criteria: The pilot should be able to demonstrate an understanding of the methodology used by a TAWS to issue cautions and warnings and the general criteria for the issuance of these alerts, including awareness of the following:
 - (A) modes associated with basic GPWS, including the input data associated with each; and
 - (B) visual and aural annunciations that can be issued by TAWS and how to identify which are cautions and which are warnings.
- (3) TAWS manoeuvre training. The pilot should demonstrate the knowledge required to respond correctly to TAWS cautions and warnings. This training should address the following topics:
 - (i) Response to cautions:
 - (A) Objective: To verify that the pilot properly interprets and responds to cautions. Criteria: The pilot should demonstrate an understanding of the need, without delay:
 - (a) to initiate action required to correct the condition which has caused the TAWS to issue the caution and to be prepared to respond to a warning, if this should follow; and
 - (b) if a warning does not follow the caution, to notify the controller of the new position, heading and/or altitude/flight level of the aircraft, and what the commander intends to do next.
 - (B) The correct response to a caution might require the pilot to:
 - (a) reduce a rate of descent and/or to initiate a climb;
 - (b) regain an ILS glide path from below, or to inhibit a glide path signal if an ILS is not being flown;
 - (c) select more flap, or to inhibit a flap sensor if the landing is being conducted with the intent that the normal flap setting will not be used;
 - (d) select gear down; and/or
 - (e) initiate a turn away from the terrain or obstacle ahead and towards an area free of such obstructions if a forward-looking terrain display indicates that this would be a good solution and the entire manoeuvre can be carried out in clear visual conditions.
 - (ii) Response to warnings. Objective: To verify that the pilot properly interprets and responds to warnings. Criteria: The pilot should demonstrate an understanding of the following:
 - (A) The need, without delay, to initiate a climb in the manner specified by the operator.
 - (B) The need, without delay, to maintain the climb until visual verification can be made that the aircraft will clear the terrain or obstacle ahead or until above

the appropriate sector safe altitude (if certain about the location of the aircraft with respect to terrain) even if the TAWS warning stops. If, subsequently, the aircraft climbs up through the sector safe altitude, but the visibility does not allow the flight crew to confirm that the terrain hazard has ended, checks should be made to verify the location of the aircraft and to confirm that the altimeter subscale settings are correct.

- (C) When the workload permits that, the flight crew should notify the air traffic controller of the new position and altitude/flight level, and what the commander intends to do next.
 - (D) That the manner in which the climb is made should reflect the type of aircraft and the method specified by the aircraft manufacturer (which should be reflected in the operations manual) for performing the escape manoeuvre. Essential aspects will include the need for an increase in pitch attitude, selection of maximum thrust, confirmation that external sources of drag (e.g. spoilers/speed brakes) are retracted, and respect of the stick shaker or other indication of eroded stall margin.
 - (E) That TAWS warnings should never be ignored. However, the pilot's response may be limited to that which is appropriate for a caution, only if:
 - (a) the aircraft is being operated by day in clear, visual conditions; and
 - (b) it is immediately clear to the pilot that the aircraft is in no danger in respect of its configuration, proximity to terrain or current flight path.
- (4) TAWS initial evaluation:
- (i) The flight crew member's understanding of the academic training items should be assessed by means of a written test.
 - (ii) The flight crew member's understanding of the manoeuvre training items should be assessed in a FSTD equipped with TAWS visual and aural displays and inhibit selectors similar in appearance and operation to those in the aircraft which the pilot will fly. The results should be assessed by a synthetic flight instructor, synthetic flight examiner, type rating instructor or type rating examiner.
 - (iii) The range of scenarios should be designed to give confidence that proper and timely responses to TAWS cautions and warnings will result in the aircraft avoiding a CFIT accident. To achieve this objective, the pilot should demonstrate taking the correct action to prevent a caution developing into a warning and, separately, the escape manoeuvre needed in response to a warning. These demonstrations should take place when the external visibility is zero, though there is much to be learnt if, initially, the training is given in 'mountainous' or 'hilly' terrain with clear visibility. This training should comprise a sequence of scenarios, rather than be included in line oriented flight training (LOFT).
 - (iv) A record should be made, after the pilot has demonstrated competence, of the scenarios that were practised.
- (5) TAWS recurrent training:
- (i) TAWS recurrent training ensures that pilots maintain the appropriate TAWS knowledge and skills. In particular, it reminds pilots of the need to act promptly in response to cautions and warnings, and of the unusual attitude associated with flying the escape manoeuvre.

- (ii) An essential item of recurrent training is the discussion of any significant issues and operational concerns that have been identified by the operator. Recurrent training should also address changes to TAWS logic, parameters or procedures and to any unique TAWS characteristics of which pilots should be aware.
- (6) Reporting procedures:
- (i) Verbal reports. Verbal reports should be made promptly to the appropriate air traffic control unit:
 - (A) whenever any manoeuvre has caused the aircraft to deviate from an air traffic clearance;
 - (B) when, following a manoeuvre which has caused the aircraft to deviate from an air traffic clearance, the aircraft has returned to a flight path which complies with the clearance; and/or
 - (C) when an air traffic control unit issues instructions which, if followed, would cause the pilot to manoeuvre the aircraft towards terrain or obstacle or it would appear from the display that a potential CFIT occurrence is likely to result.
 - (ii) Written reports. Written reports should be submitted in accordance with the operator's occurrence reporting scheme and they also should be recorded in the aircraft technical log:
 - (A) whenever the aircraft flight path has been modified in response to a TAWS alert (false, nuisance or genuine);
 - (B) whenever a TAWS alert has been issued and is believed to have been false; and/or
 - (C) if it is believed that a TAWS alert should have been issued, but was not.
 - (iii) Within this GM and with regard to reports:
 - (A) the term 'false' means that the TAWS issued an alert which could not possibly be justified by the position of the aircraft in respect to terrain and it is probable that a fault or failure in the system (equipment and/or input data) was the cause;
 - (B) the term 'nuisance' means that the TAWS issued an alert which was appropriate, but was not needed because the flight crew could determine by independent means that the flight path was, at that time, safe;
 - (C) the term 'genuine' means that the TAWS issued an alert which was both appropriate and necessary; and
 - (D) the report terms described in (c)(6)(iii) are only meant to be assessed after the occurrence is over, to facilitate subsequent analysis, the adequacy of the equipment and the programmes it contains. The intention is not for the flight crew to attempt to classify an alert into any of these three categories when visual and/or aural cautions or warnings are annunciated.

CAT.OP.MPA.295 Use of airborne collision avoidance system (ACAS)

The operator shall establish operational procedures and training programmes when ACAS is installed and serviceable so that the flight crew is appropriately trained in the avoidance of collisions and competent in the use of ACAS II equipment.

GM1 CAT.OP.MPA.295 Use of airborne collision avoidance system (ACAS)

GENERAL

- (a) The ACAS operational procedures and training programmes established by the operator should take into account this GM. It incorporates advice contained in:
- (1) ICAO Annex 10, Volume IV;
 - (2) ICAO PANS-OPS, Volume 1;
 - (3) ICAO PANS-ATM; and
 - (4) ICAO guidance material 'ACAS Performance-Based Training Objectives' (published under Attachment E of State Letter AN 7/1.3.7.2-97/77).
- (b) Additional guidance material on ACAS may be referred to, including information available from such sources as EUROCONTROL.

ACAS FLIGHT CREW TRAINING PROGRAMMES

- (c) During the implementation of ACAS, several operational issues were identified which had been attributed to deficiencies in flight crew training programmes. As a result, the issue of flight crew training has been discussed within the ICAO, which has developed guidelines for operators to use when designing training programmes.
- (d) This GM contains performance-based training objectives for ACAS II flight crew training. Information contained in this paper related to traffic advisories (TAs) is also applicable to ACAS I and ACAS II users. The training objectives cover five areas: theory of operation; pre-flight operations; general in-flight operations; response to TAs; and response to resolution advisories (RAs).
- (e) The information provided is valid for version 7 and 7.1 (ACAS II). Where differences arise, these are identified.
- (f) The performance-based training objectives are further divided into the areas of: academic training; manoeuvre training; initial evaluation and recurrent qualification. Under each of these four areas, the training material has been separated into those items which are considered essential training items and those which are considered desirable. In each area, objectives and acceptable performance criteria are defined.
- (g) ACAS academic training
- (1) This training is typically conducted in a classroom environment. The knowledge demonstrations specified in this section may be completed through the successful completion of written tests or through providing correct responses to non-real-time computer-based training (CBT) questions.
 - (2) Essential items
 - (i) Theory of operation. The flight crew member should demonstrate an understanding of ACAS II operation and the criteria used for issuing TAs and RAs. This training should address the following topics:

(A) System operation

Objective: to demonstrate knowledge of how ACAS functions.

Criteria: the flight crew member should demonstrate an understanding of the following functions:

(a) Surveillance

- (1) ACAS interrogates other transponder-equipped aircraft within a nominal range of 14 NM.
- (2) ACAS surveillance range can be reduced in geographic areas with a large number of ground interrogators and/or ACAS II-equipped aircraft.
- (3) If the operator's ACAS implementation provides for the use of the Mode S extended squitter, the normal surveillance range may be increased beyond the nominal 14 NM. However, this information is not used for collision avoidance purposes.

(b) Collision avoidance

- (1) TAs can be issued against any transponder-equipped aircraft which responds to the ICAO Mode C interrogations, even if the aircraft does not have altitude reporting capability.
- (2) RAs can be issued only against aircraft that are reporting altitude and in the vertical plane only.
- (3) RAs issued against an ACAS-equipped intruder are co-ordinated to ensure complementary RAs are issued.
- (4) Failure to respond to an RA deprives own aircraft of the collision protection provided by own ACAS.
- (5) Additionally, in ACAS-ACAS encounters, failure to respond to an RA also restricts the choices available to the other aircraft's ACAS and thus renders the other aircraft's ACAS less effective than if own aircraft were not ACAS-equipped.

(B) Advisory thresholds

Objective: to demonstrate knowledge of the criteria for issuing TAs and RAs.

Criteria: the flight crew member should demonstrate an understanding of the methodology used by ACAS to issue TAs and RAs and the general criteria for the issuance of these advisories, including the following:

- (a) ACAS advisories are based on time to closest point of approach (CPA) rather than distance. The time should be short and vertical separation should be small, or projected to be small, before an advisory can be issued. The separation standards provided by ATS are different from the miss distances against which ACAS issues alerts.
- (b) Thresholds for issuing a TA or an RA vary with altitude. The thresholds are larger at higher altitudes.
- (c) A TA occurs from 15 to 48 seconds and an RA from 15 to 35 seconds before the projected CPA.

- (d) RAs are chosen to provide the desired vertical miss distance at CPA. As a result, RAs can instruct a climb or descent through the intruder aircraft's altitude.

(C) ACAS limitations

Objective: to verify that the flight crew member is aware of the limitations of ACAS.

Criteria: the flight crew member should demonstrate knowledge and understanding of ACAS limitations, including the following:

- (a) ACAS will neither track nor display non-transponder-equipped aircraft, nor aircraft not responding to ACAS Mode C interrogations.
- (b) ACAS will automatically fail if the input from the aircraft's barometric altimeter, radio altimeter or transponder is lost.
 - (1) In some installations, the loss of information from other on board systems such as an inertial reference system (IRS) or attitude heading reference system (AHRS) may result in an ACAS failure. Individual operators should ensure that their flight crews are aware of the types of failure that will result in an ACAS failure.
 - (2) ACAS may react in an improper manner when false altitude information is provided to own ACAS or transmitted by another aircraft. Individual operators should ensure that their flight crew are aware of the types of unsafe conditions that can arise. Flight crew members should ensure that when they are advised, if their own aircraft is transmitting false altitude reports, an alternative altitude reporting source is selected, or altitude reporting is switched off.
- (c) Some aeroplanes within 380 ft above ground level (AGL) (nominal value) are deemed to be 'on ground' and will not be displayed. If ACAS is able to determine an aircraft below this altitude is airborne, it will be displayed.
- (d) ACAS may not display all proximate transponder-equipped aircraft in areas of high density traffic.
- (e) The bearing displayed by ACAS is not sufficiently accurate to support the initiation of horizontal manoeuvres based solely on the traffic display.
- (f) ACAS will neither track nor display intruders with a vertical speed in excess of 10 000 ft/min. In addition, the design implementation may result in some short-term errors in the tracked vertical speed of an intruder during periods of high vertical acceleration by the intruder.
- (g) Ground proximity warning systems/ground collision avoidance systems (GPWSs/GCASs) warnings and wind shear warnings take precedence over ACAS advisories. When either a GPWS/GCAS or wind shear warning is active, ACAS aural annunciations will be inhibited and ACAS will automatically switch to the 'TA only' mode of operation.

(D) ACAS inhibits

Objective: to verify that the flight crew member is aware of the conditions under which certain functions of ACAS are inhibited.

Criteria: the flight crew member should demonstrate knowledge and understanding of the various ACAS inhibits, including the following:

- (a) 'Increase Descent' RAs are inhibited below 1 450 ft AGL;
- (b) 'Descend' RAs are inhibited below 1 100 ft AGL;
- (c) all RAs are inhibited below 1 000 ft AGL;
- (d) all TA aural annunciations are inhibited below 500 ft AGL; and
- (e) altitude and configuration under which 'Climb' and 'Increase Climb' RAs are inhibited. ACAS can still issue 'Climb' and 'Increase Climb' RAs when operating at the aeroplane's certified ceiling. (In some aircraft types, 'Climb' or 'Increase Climb' RAs are never inhibited.)

(ii) Operating procedures

The flight crew member should demonstrate the knowledge required to operate the ACAS avionics and interpret the information presented by ACAS. This training should address the following:

(A) Use of controls

Objective: to verify that the pilot can properly operate all ACAS and display controls.

Criteria: demonstrate the proper use of controls including:

- (a) aircraft configuration required to initiate a self-test;
- (b) steps required to initiate a self-test;
- (c) recognising when the self-test was successful and when it was unsuccessful. When the self-test is unsuccessful, recognising the reason for the failure and, if possible, correcting the problem;
- (d) recommended usage of range selection. Low ranges are used in the terminal area and the higher display ranges are used in the en-route environment and in the transition between the terminal and en-route environment;
- (e) recognising that the configuration of the display does not affect the ACAS surveillance volume;
- (f) selection of lower ranges when an advisory is issued, to increase display resolution;
- (g) proper configuration to display the appropriate ACAS information without eliminating the display of other needed information;
- (h) if available, recommended usage of the above/below mode selector. The above mode should be used during climb and the below mode should be used during descent; and
- (i) if available, proper selection of the display of absolute or relative altitude and the limitations of using this display if a barometric correction is not provided to ACAS.

(B) Display interpretation

Objective: to verify that the flight crew member understands the meaning of all information that can be displayed by ACAS. The wide variety of display implementations require the tailoring of some criteria. When the training programme is developed, these criteria should be expanded to cover details for the operator's specific display implementation.

Criteria: the flight crew member should demonstrate the ability to properly interpret information displayed by ACAS, including the following:

- (a) other traffic, i.e. traffic within the selected display range that is not proximate traffic, or causing a TA or RA to be issued;
- (b) proximate traffic, i.e. traffic that is within 6 NM and $\pm 1\ 200$ ft;
- (c) non-altitude reporting traffic;
- (d) no bearing TAs and RAs;
- (e) off-scale TAs and RAs: the selected range should be changed to ensure that all available information on the intruder is displayed;
- (f) TAs: the minimum available display range which allows the traffic to be displayed should be selected, to provide the maximum display resolution;
- (g) RAs (traffic display): the minimum available display range of the traffic display which allows the traffic to be displayed should be selected, to provide the maximum display resolution;
- (h) RAs (RA display): flight crew members should demonstrate knowledge of the meaning of the red and green areas or the meaning of pitch or flight path angle cues displayed on the RA display. Flight crew members should also demonstrate an understanding of the RA display limitations, i.e. if a vertical speed tape is used and the range of the tape is less than 2 500 ft/min, an increase rate RA cannot be properly displayed; and
- (i) if appropriate, awareness that navigation displays oriented on 'Track-Up' may require a flight crew member to make a mental adjustment for drift angle when assessing the bearing of proximate traffic.

(C) Use of the TA-only mode

Objective: to verify that a flight crew member understands the appropriate times to select the TA-only mode of operation and the limitations associated with using this mode.

Criteria: the flight crew member should demonstrate the following:

- (a) Knowledge of the operator's guidance for the use of TA only.
- (b) Reasons for using this mode. If TA only is not selected when an airport is conducting simultaneous operations from parallel runways separated by less than 1 200 ft, and to some intersecting runways, RAs can be expected. If for any reason TA only is not selected and an RA is received in these situations, the response should comply with the operator's approved procedures.

- (c) All TA aural annunciations are inhibited below 500 ft AGL. As a result, TAs issued below 500 ft AGL may not be noticed unless the TA display is included in the routine instrument scan.

(D) Crew coordination

Objective: to verify that the flight crew member understands how ACAS advisories will be handled.

Criteria: the flight crew member should demonstrate knowledge of the crew procedures that should be used when responding to TAs and RAs, including the following:

- (a) task sharing between the pilot flying and the pilot monitoring;
- (b) expected call-outs; and
- (c) communications with ATC.

(E) Phraseology rules

Objective: to verify that the flight crew member is aware of the rules for reporting RAs to the controller.

Criteria: the flight crew member should demonstrate the following:

- (a) the use of the phraseology contained in ICAO PANS-OPS;
- (b) an understanding of the procedures contained in ICAO PANS-ATM and ICAO Annex 2; and
- (c) the understanding that verbal reports should be made promptly to the appropriate ATC unit:
 - (1) whenever any manoeuvre has caused the aeroplane to deviate from an air traffic clearance;
 - (2) when, subsequent to a manoeuvre that has caused the aeroplane to deviate from an air traffic clearance, the aeroplane has returned to a flight path that complies with the clearance; and/or
 - (3) when air traffic issue instructions that, if followed, would cause the crew to manoeuvre the aircraft contrary to an RA with which they are complying.

(F) Reporting rules

Objective: to verify that the flight crew member is aware of the rules for reporting RAs to the operator.

Criteria: the flight crew member should demonstrate knowledge of where information can be obtained regarding the need for making written reports to various states when an RA is issued. Various States have different reporting rules and the material available to the flight crew member should be tailored to the operator's operating environment. For operators involved in commercial operations, this responsibility is satisfied by the flight crew member reporting to the operator according to the applicable reporting rules.

(3) Non-essential items: advisory thresholds

Objective: to demonstrate knowledge of the criteria for issuing TAs and RAs.

Criteria: the flight crew member should demonstrate an understanding of the methodology used by ACAS to issue TAs and RAs and the general criteria for the issuance of these advisories, including the following:

- (i) the minimum and maximum altitudes below/above which TAs will not be issued;
 - (ii) when the vertical separation at CPA is projected to be less than the ACAS-desired separation, a corrective RA which requires a change to the existing vertical speed will be issued. This separation varies from 300 ft at low altitude to a maximum of 700 ft at high altitude;
 - (iii) when the vertical separation at CPA is projected to be just outside the ACAS-desired separation, a preventive RA that does not require a change to the existing vertical speed will be issued. This separation varies from 600 to 800 ft; and
 - (iv) RA fixed range thresholds vary between 0.2 and 1.1 NM.
- (h) ACAS manoeuvre training
- (1) Demonstration of the flight crew member's ability to use ACAS displayed information to properly respond to TAs and RAs should be carried out in a full flight simulator equipped with an ACAS display and controls similar in appearance and operation to those in the aircraft. If a full flight simulator is utilised, CRM should be practised during this training.
 - (2) Alternatively, the required demonstrations can be carried out by means of an interactive CBT with an ACAS display and controls similar in appearance and operation to those in the aircraft. This interactive CBT should depict scenarios in which real-time responses should be made. The flight crew member should be informed whether or not the responses made were correct. If the response was incorrect or inappropriate, the CBT should show what the correct response should be.
 - (3) The scenarios included in the manoeuvre training should include: corrective RAs; initial preventive RAs; maintain rate RAs; altitude crossing RAs; increase rate RAs; RA reversals; weakening RAs; and multi-aircraft encounters. The consequences of failure to respond correctly should be demonstrated by reference to actual incidents such as those publicised in EUROCONTROL ACAS II Bulletins (available on the EUROCONTROL website).
- (i) TA responses
- Objective: to verify that the pilot properly interprets and responds to TAs.
- Criteria: the pilot should demonstrate the following:
- (A) Proper division of responsibilities between the pilot flying and the pilot monitoring. The pilot flying should fly the aircraft using any type-specific procedures and be prepared to respond to any RA that might follow. For aircraft without an RA pitch display, the pilot flying should consider the likely magnitude of an appropriate pitch change. The pilot monitoring should provide updates on the traffic location shown on the ACAS display, using this information to help visually acquire the intruder.
 - (B) Proper interpretation of the displayed information. Flight crew members should confirm that the aircraft they have visually acquired is that which has caused the TA to be issued. Use should be made of all information shown on the display, note being taken of the bearing and range of the intruder (amber circle), whether it is above or below (data tag) and its vertical speed direction (trend arrow).

- (C) Other available information should be used to assist in visual acquisition, including ATC 'party-line' information, traffic flow in use, etc.
- (D) Because of the limitations described, the pilot flying should not manoeuvre the aircraft based solely on the information shown on the ACAS display. No attempt should be made to adjust the current flight path in anticipation of what an RA would advise, except that if own aircraft is approaching its cleared level at a high vertical rate with a TA present, vertical rate should be reduced to less than 1 500 ft/min.
- (E) When visual acquisition is attained, and as long as no RA is received, normal right of way rules should be used to maintain or attain safe separation. No unnecessary manoeuvres should be initiated. The limitations of making manoeuvres based solely on visual acquisition, especially at high altitude or at night, or without a definite horizon should be demonstrated as being understood.

(ii) RA responses

Objective: to verify that the pilot properly interprets and responds to RAs.

Criteria: the pilot should demonstrate the following:

- (A) Proper response to the RA, even if it is in conflict with an ATC instruction and even if the pilot believes that there is no threat present.
- (B) Proper task sharing between the pilot flying and the pilot monitoring. The pilot flying should respond to a corrective RA with appropriate control inputs. The pilot monitoring should monitor the response to the RA and should provide updates on the traffic location by checking the traffic display. Proper crew resource management (CRM) should be used.
- (C) Proper interpretation of the displayed information. The pilot should recognise the intruder causing the RA to be issued (red square on display). The pilot should respond appropriately.
- (D) For corrective RAs, the response should be initiated in the proper direction within five seconds of the RA being displayed. The change in vertical speed should be accomplished with an acceleration of approximately $\frac{1}{4} g$ (gravitational acceleration of 9.81 m/sec^2).
- (E) Recognition of the initially displayed RA being modified. Response to the modified RA should be properly accomplished, as follows:
 - (a) For increase rate RAs, the vertical speed change should be started within two and a half seconds of the RA being displayed. The change in vertical speed should be accomplished with an acceleration of approximately $\frac{1}{2} g$.
 - (b) For RA reversals, the vertical speed reversal should be started within two and a half seconds of the RA being displayed. The change in vertical speed should be accomplished with an acceleration of approximately $\frac{1}{3} g$.
 - (c) For RA weakenings, the vertical speed should be modified to initiate a return towards the original clearance.

- (d) An acceleration of approximately $\frac{1}{4}$ g will be achieved if the change in pitch attitude corresponding to a change in vertical speed of 1 500 ft/min is accomplished in approximately 5 seconds, and of $\frac{1}{3}$ g if the change is accomplished in approximately three seconds. The change in pitch attitude required to establish a rate of climb or descent of 1 500 ft/min from level flight will be approximately 6° when the true airspeed (TAS) is 150 kt, 4° at 250 kt, and 2° at 500 kt. (These angles are derived from the formula: 1 000 divided by TAS.).
 - (F) Recognition of altitude crossing encounters and the proper response to these RAs.
 - (G) For preventive RAs, the vertical speed needle or pitch attitude indication should remain outside the red area on the RA display.
 - (H) For maintain rate RAs, the vertical speed should not be reduced. Pilots should recognise that a maintain rate RA may result in crossing through the intruder's altitude.
 - (I) When the RA weakens, or when the green 'fly to' indicator changes position, the pilot should initiate a return towards the original clearance and when 'clear of conflict' is annunciated, the pilot should complete the return to the original clearance.
 - (J) The controller should be informed of the RA as soon as time and workload permit, using the standard phraseology.
 - (K) When possible, an ATC clearance should be complied with while responding to an RA. For example, if the aircraft can level at the assigned altitude while responding to RA (an 'adjust vertical speed' RA (version 7) or 'level off' (version 7.1)) it should be done; the horizontal (turn) element of an ATC instruction should be followed.
 - (L) Knowledge of the ACAS multi-aircraft logic and its limitations, and that ACAS can optimise separations from two aircraft by climbing or descending towards one of them. For example, ACAS only considers intruders that it considers to be a threat when selecting an RA. As such, it is possible for ACAS to issue an RA against one intruder that results in a manoeuvre towards another intruder which is not classified as a threat. If the second intruder becomes a threat, the RA will be modified to provide separation from that intruder.
- (i) ACAS initial evaluation
- (1) The flight crew member's understanding of the academic training items should be assessed by means of a written test or interactive CBT that records correct and incorrect responses to phrased questions.
 - (2) The flight crew member's understanding of the manoeuvre training items should be assessed in a full flight simulator equipped with an ACAS display and controls similar in appearance and operation to those in the aircraft the flight crew member will fly, and the results assessed by a qualified instructor, inspector, or check airman. The range of scenarios should include: corrective RAs; initial preventive RAs; maintain rate RAs; altitude crossing RAs; increase rate RAs; RA reversals; weakening RAs; and multi-threat encounters. The scenarios should also include demonstrations of the consequences of not responding to RAs, slow or late responses, and manoeuvring opposite to the direction called for by the displayed RA.

-
- (3) Alternatively, exposure to these scenarios can be conducted by means of an interactive CBT with an ACAS display and controls similar in appearance and operation to those in the aircraft the pilot will fly. This interactive CBT should depict scenarios in which real-time responses should be made and a record made of whether or not each response was correct.
- (j) ACAS recurrent training
- (1) ACAS recurrent training ensures that flight crew members maintain the appropriate ACAS knowledge and skills. ACAS recurrent training should be integrated into and/or conducted in conjunction with other established recurrent training programmes. An essential item of recurrent training is the discussion of any significant issues and operational concerns that have been identified by the operator. Recurrent training should also address changes to ACAS logic, parameters or procedures and to any unique ACAS characteristics which flight crew members should be made aware of.
- (2) It is recommended that the operator's recurrent training programmes using full flight simulators include encounters with conflicting traffic when these simulators are equipped with ACAS. The full range of likely scenarios may be spread over a 2-year period. If a full flight simulator, as described above, is not available, use should be made of interactive CBT that is capable of presenting scenarios to which pilot responses should be made in real time.

CAT.OP.MPA.300 Approach and landing conditions

Before commencing an approach to land, the commander shall be satisfied that, according to the information available to him/her, the weather at the aerodrome and the condition of the runway or FATO intended to be used should not prevent a safe approach, landing or missed approach, having regard to the performance information contained in the operations manual.

AMC1 CAT.OP.MPA.300 Approach and landing conditions**IN-FLIGHT DETERMINATION OF THE LANDING DISTANCE**

The in-flight determination of the landing distance should be based on the latest available meteorological or runway state report, preferably not more than 30 minutes before the expected landing time.

CAT.OP.MPA.305 Commencement and continuation of approach

- (a) The commander or the pilot to whom conduct of the flight has been delegated may commence an instrument approach regardless of the reported RVR/VIS.
- (b) If the reported RVR/VIS is less than the applicable minimum the approach shall not be continued:
 - (1) below 1 000 ft above the aerodrome; or
 - (2) into the final approach segment in the case where the DA/H or MDA/H is more than 1 000 ft above the aerodrome.
- (c) Where the RVR is not available, RVR values may be derived by converting the reported visibility.
- (d) If, after passing 1 000 ft above the aerodrome, the reported RVR/VIS falls below the applicable minimum, the approach may be continued to DA/H or MDA/H.
- (e) The approach may be continued below DA/H or MDA/H and the landing may be completed provided that the visual reference adequate for the type of approach operation and for the intended runway is established at the DA/H or MDA/H and is maintained.
- (f) The touchdown zone RVR shall always be controlling. If reported and relevant, the midpoint and stopend RVR shall also be controlling. The minimum RVR value for the midpoint shall be 125 m or the RVR required for the touchdown zone if less, and 75 m for the stopend. For aircraft equipped with a rollout guidance or control system, the minimum RVR value for the midpoint shall be 75 m.

AMC1 CAT.OP.MPA.305(e) Commencement and continuation of approach

VISUAL REFERENCES FOR INSTRUMENT APPROACH OPERATIONS

- (a) NPA, APV and CAT I operations
At DH or MDH, at least one of the visual references specified below should be distinctly visible and identifiable to the pilot:
 - (1) elements of the approach lighting system;
 - (2) the threshold;
 - (3) the threshold markings;
 - (4) the threshold lights;
 - (5) the threshold identification lights;
 - (6) the visual glide slope indicator;
 - (7) the touchdown zone or touchdown zone markings;
 - (8) the touchdown zone lights;
 - (9) FATO/runway edge lights; or
 - (10) other visual references specified in the operations manual.
- (b) LTS CAT I operations
At DH, the visual references specified below should be distinctly visible and identifiable to the pilot:
 - (1) a segment of at least three consecutive lights, being the centreline of the approach lights, or touchdown zone lights, or runway centreline lights, or runway edge lights, or a combination of them;

- (2) this visual reference should include a lateral element of the ground pattern, such as an approach light crossbar or the landing threshold or a barrette of the touchdown zone light unless the operation is conducted utilising an approved HUDLS usable to at least 150 ft.
- (c) CAT II or OTS CAT II operations
- At DH, the visual references specified below should be distinctly visible and identifiable to the pilot:
- (1) a segment of at least three consecutive lights being the centreline of the approach lights, or touchdown zone lights, or runway centreline lights, or runway edge lights, or a combination of them;
- (2) this visual reference should include a lateral element of the ground pattern, such as an approach light crossbar or the landing threshold or a barrette of the touchdown zone light unless the operation is conducted utilising an approved HUDLS to touchdown.
- (d) CAT III operations
- (1) For CAT IIIA operations and for CAT IIIB operations conducted either with fail-passive flight control systems or with the use of an approved HUDLS: at DH, a segment of at least three consecutive lights being the centreline of the approach lights, or touchdown zone lights, or runway centreline lights, or runway edge lights, or a combination of these is attained and can be maintained by the pilot.
- (2) For CAT IIIB operations conducted either with fail-operational flight control systems or with a fail-operational hybrid landing system using a DH: at DH, at least one centreline light is attained and can be maintained by the pilot.
- (3) For CAT IIIB operations with no DH, there is no specification for visual reference with the runway prior to touchdown.
- (e) Approach operations utilising EVS — CAT I operations
- (1) At DH, the following visual references should be displayed and identifiable to the pilot on the EVS image:
- (i) elements of the approach light; or
- (ii) the runway threshold, identified by at least one of the following:
- (A) the beginning of the runway landing surface,
- (B) the threshold lights, the threshold identification lights; or
- (C) the touchdown zone, identified by at least one of the following: the runway touchdown zone landing surface, the touchdown zone lights, the touchdown zone markings or the runway lights.
- (2) At 100 ft above runway threshold elevation, at least one of the visual references specified below should be distinctly visible and identifiable to the pilot without reliance on the EVS:
- (i) the lights or markings of the threshold; or
- (ii) the lights or markings of the touchdown zone.
- (f) Approach operations utilising EVS — APV and NPA operations flown with the CDFA technique
- (1) At DH/MDH, visual references should be displayed and identifiable to the pilot on the EVS image as specified under (a).

- (2) At 200 ft above runway threshold elevation, at least one of the visual references specified under (a) should be distinctly visible and identifiable to the pilot without reliance on the EVS.

GM1 CAT.OP.MPA.305(f) Commencement and continuation of approach

EXPLANATION OF THE TERM 'RELEVANT'

'Relevant' in this context means that part of the runway used during the high-speed phase of the landing down to a speed of approximately 60 kt.

CAT.OP.MPA.310 Operating procedures — threshold crossing height — aeroplanes

The operator shall establish operational procedures designed to ensure that an aeroplane conducting precision approaches crosses the threshold of the runway by a safe margin, with the aeroplane in the landing configuration and attitude.

CAT.OP.MPA.315 Flight hours reporting — helicopters

The operator shall make available to the competent authority the hours flown for each helicopter operated during the previous calendar year.

GM1 CAT.OP.MPA.315 Flight hours reporting — helicopters

FLIGHT HOURS REPORTING

- (a) The requirement in CAT.OP.MPA.315 may be achieved by making available either:
 - (1) the flight hours flown by each helicopter — identified by its serial number and registration mark — during the previous calendar year; or
 - (2) the total flight hours of each helicopter — identified by its serial number and registration mark — on the 31st of December of the previous calendar year.
- (b) Where possible, the operator should have available, for each helicopter, the breakdown of hours for CAT operations. If the exact hours for the functional activity cannot be established, the estimated proportion will be sufficient.

CAT.OP.MPA.320 Aircraft categories

- (a) Aircraft categories shall be based on the indicated airspeed at threshold (V_{AT}) which is equal to the stalling speed (V_{SO}) multiplied by 1,3 or one-g (gravity) stall speed (V_{S1g}) multiplied by 1,23 in the landing configuration at the maximum certified landing mass. If both V_{SO} and V_{S1g} are available, the higher resulting V_{AT} shall be used.
- (b) The aircraft categories specified in the table below shall be used.

*Table 1***Aircraft categories corresponding to V_{AT} values**

Aircraft category	V_{AT}
A	Less than 91 kt
B	From 91 to 120 kt
C	From 121 to 140 kt
D	From 141 to 165 kt
E	From 166 to 210 kt

- (c) The landing configuration that is to be taken into consideration shall be specified in the operations manual.
- (d) The operator may apply a lower landing mass for determining the V_{AT} if approved by the competent authority. Such a lower landing mass shall be a permanent value, independent of the changing conditions of day-to-day operations.

SECTION 2
Non motor-powered aircraft

CAT.OP.NMPA.100 Use of aerodromes and operating sites

The operator shall only use aerodromes and operating sites that are adequate for the type(s) of aircraft and operation(s) concerned.

GM1 CAT.OP.NMPA.100 Use of aerodromes and operating sites

BALLOONS

An adequate operating site is a site that the commander considers to be satisfactory, taking account of the applicable performance requirements and site characteristics.

CAT.OP.NMPA.105 Noise abatement procedures — balloons and powered sailplanes

The commander shall take into account the effect of aircraft noise while ensuring that safety has priority over noise abatement.

CAT.OP.NMPA.110 Fuel or ballast supply and planning — balloons

- (a) The operator shall ensure that the fuel or ballast carried is sufficient for the intended flight duration plus a reserve of 30 minutes of flight.
- (b) Fuel or ballast supply calculations shall be based upon at least the following operating conditions under which the flight is to be conducted:
 - (1) data provided by the balloon manufacturer;
 - (2) anticipated masses;
 - (3) expected meteorological conditions; and
 - (4) air navigation services provider(s) procedures and restrictions.
- (c) The calculations shall be documented in an operational flight plan.

CAT.OP.NMPA.115 Carriage of special categories of passengers (SCPs)

Persons requiring special conditions, assistance and/or devices when carried on a flight shall be considered as SCPs and be carried under conditions that ensure the safety of the aircraft and its occupants according to procedures established by the operator.

AMC1 CAT.OP.NMPA.115 Carriage of special categories of passengers (SCPs)**CARRIAGE OF CHILDREN AND PERSONS WITH REDUCED MOBILITY — BALLOONS**

The operator may exclude children and/or persons with reduced mobility (PRM)s from transportation in a balloon, when:

- (a) their presence may impede:
 - (1) the crew in their duties;
 - (2) access to emergency equipment; or
 - (3) the emergency evacuation of the balloon;and/or
- (b) those persons are:
 - (1) unable to take a proper brace position; or
 - (2) shorter than the inner height of the basket wall.

CAT.OP.NMPA.120 Passenger briefing

The operator shall ensure that passengers are given a safety briefing before or, where appropriate, during the flight.

AMC1 CAT.OP.NMPA.120 Passenger briefing

SAILPLANES

The briefing should include the locations and use of seat belts and if applicable:

- (a) emergency canopy opening;
- (b) use of the parachute;
- (c) oxygen dispensing equipment;
- (d) passenger emergency briefing cards; and
- (e) other emergency equipment, where provided for individual passenger use.

AMC2 CAT.OP.NMPA.120 Passenger briefing

BALLOONS

- (a) Passengers should be given a verbal briefing and demonstration about safety matters in such a way that the information is easily retained and reproduced during the landing and in the case of an emergency situation.
- (b) The briefing/demonstration should contain the following items:
 - (1) use of landing hand-holds;
 - (2) use of oxygen dispensing equipment, if applicable;
 - (3) other emergency equipment, where provided for individual passenger use;
 - (4) wearing of suitable clothing;
 - (5) smoking regulations and the use of portable electronic devices;
 - (6) stowage of baggage;
 - (7) importance to remain inside the basket at all times, particularly after landing;
 - (8) landing positions to be assumed to minimise the effect of the impact upon an emergency landing; and
 - (9) safe transport of the balloon on the ground after landing.
- (c) Part or all of the verbal briefing may be provided additionally by a safety briefing card on which pictorial instructions indicate the correct landing position.
- (d) Before take-off, the correct landing position should be demonstrated.
- (e) Before commencing the landing phase, passengers should be required to practise the correct landing position.

CAT.OP.NMPA.125 Flight preparation

Before commencing the flight, the commander shall:

- (a) ascertain by every reasonable means available that the ground facilities including communication facilities and navigation aids available and directly required on such a flight, for the safe operation of the aircraft, are adequate for the type of operation under which the flight is to be conducted; and
- (b) be familiar with all available meteorological information appropriate to the intended flight. Preparation for a flight away from the vicinity of the place of departure shall include:
 - (1) a study of available current weather reports and forecasts; and
 - (2) the planning of an alternative course of action to provide for the eventuality that the flight cannot be completed as planned, because of weather conditions.

AMC1 CAT.OP.NMPA.125(a) Flight preparation**GROUND FACILITIES**

NOTAMS should be considered as an appropriate means to gather the required information.

CAT.OP.NMPA.130 Submission of the ATS flight plan

- (a) If an ATS flight plan is not submitted because it is not required by the rules of the air, adequate information shall be deposited in order to permit alerting services to be activated if required.
- (b) When operating from a site where it is impossible to submit an ATS flight plan, the ATS flight plan shall be transmitted as soon as possible after take-off by the commander or the operator.

AMC1 CAT.OP.NMPA.130 Submission of the ATS flight plan

FLIGHTS WITHOUT ATS FLIGHT PLAN

- (a) The operator should nominate a person to be responsible for alerting search and rescue services for flights without submitted ATS flight plans.
- (b) The operator should establish procedures to ensure that each flight is located at all times and provide:
 - (1) the nominated person with at least the information required to be included in a VFR flight plan, and the location, date and estimated time for re-establishing communications;
 - (2) for notification to the appropriate ATS or search and rescue facility, if an aircraft is overdue or missing; and
 - (3) that the information is retained at a designated place until the completion of the flight.

CAT.OP.NMPA.135 Securing of passenger and pilot compartments — balloons

The commander shall ensure that before take-off and landing, and whenever deemed necessary in the interest of safety:

- (a) all equipment and baggage are properly secured; and
- (b) emergency evacuation remains possible.

CAT.OP.NMPA.140 Smoking on board

No person shall be allowed to smoke on board a sailplane or balloon.

CAT.OP.NMPA.145 Meteorological conditions

The commander shall only commence or continue a VFR flight if the latest available meteorological information indicates that the weather conditions along the route and at the intended destination at the estimated time of use will be at or above the applicable VFR operating minima.

CAT.OP.NMPA.150 Ice and other contaminants — ground procedures

The commander shall only commence take-off if the aircraft is clear of any deposit that might adversely affect the performance or controllability of the aircraft, except as permitted in accordance with the AFM.

CAT.OP.NMPA.155 Take-off conditions

Before commencing take-off, the commander shall be satisfied that according to the information available to him/her, the weather at the aerodrome or operating site would not prevent a safe take-off and departure.

AMC1 CAT.OP.NMPA.155 Take-off conditions**FACILITIES AT THE TAKE-OFF SITE — BALLOONS**

At the balloon take-off site, a means of assessing the wind direction and wind speed should be provided by the operator.

CAT.OP.NMPA.160 Simulated abnormal situations in flight

The commander shall ensure that when carrying passengers abnormal or emergency situations that require the application of abnormal or emergency procedures are not simulated.

CAT.OP.NMPA.165 In-flight fuel and ballast management — balloons

The commander shall check at regular intervals that the amount of usable fuel and ballast remaining in flight is not less than the fuel and ballast needed to complete the intended flight and the reserve planned for landing.

CAT.OP.NMPA.170 Use of supplemental oxygen

The commander shall ensure that flight crew members engaged in performing duties essential to the safe operation of the aircraft in flight use supplemental oxygen continuously whenever the pressure altitude exceeds 10 000 ft for a period of more than 30 minutes and whenever the pressure altitude exceeds 13 000 ft.

CAT.OP.NMPA.175 Approach and landing conditions

Before commencing an approach to land, the commander shall be satisfied that, according to the information available to him/her, the weather at the intended aerodrome or operating site and the condition of the surface intended to be used would not prevent a safe approach and landing.

CAT.OP.NMPA.180 Operational limitations — hot-air balloons

- (a) A hot-air balloon shall not land during night, except in emergency situation.
- (b) A hot-air balloon may take-off during night, provided sufficient fuel is carried for a landing during day.

GM1 CAT.OP.NMPA.180 Operational limitations — hot-air balloons

AVOIDANCE OF NIGHT LANDING

The intent of the rule is to ensure that when the balloon takes off during night, sufficient fuel is on board for landing under VFR by day.

The risk of collision with overhead lines is considerable and cannot be overstated. The risk is considerably increased during night flights in conditions of failing light and visibility when there is increasing pressure to land. A number of incidents have occurred in the late evening in just such conditions and may have been avoided had an earlier landing been planned. Night landings should, therefore, be avoided by taking appropriate measures including a larger quantity of fuel and/or additional safety equipment.

CAT.OP.NMPA.185 Operational limitations — sailplanes

A sailplane shall only be operated during day.

SUBPART C: AIRCRAFT PERFORMANCE AND OPERATING LIMITATIONS

SECTION 1 Aeroplanes

CHAPTER 1 General requirements

CAT.POLA.100 Performance classes

- (a) The aeroplane shall be operated in accordance with the applicable performance class requirements.
- (b) Where full compliance with the applicable requirements of this Section cannot be shown due to specific design characteristics, the operator shall apply approved performance standards that ensure a level of safety equivalent to that of the appropriate chapter.

CAT.POLA.105 General

- (a) The mass of the aeroplane:
 - (1) at the start of the take-off; or
 - (2) in the event of in-flight replanning, at the point from which the revised operational flight plan applies,shall not be greater than the mass at which the requirements of the appropriate chapter can be complied with for the flight to be undertaken. Allowance may be made for expected reductions in mass as the flight proceeds and for fuel jettisoning.
- (b) The approved performance data contained in the AFM shall be used to determine compliance with the requirements of the appropriate chapter, supplemented as necessary with other data as prescribed in the relevant chapter. The operator shall specify other data in the operations manual. When applying the factors prescribed in the appropriate chapter, account may be taken of any operational factors already incorporated in the AFM performance data to avoid double application of factors.
- (c) Due account shall be taken of aeroplane configuration, environmental conditions and the operation of systems that have an adverse effect on performance.
- (d) For performance purposes, a damp runway, other than a grass runway, may be considered to be dry.
- (e) The operator shall take account of charting accuracy when assessing the take-off requirements of the applicable chapters.

CHAPTER 2
Performance class A**CAT.POL.A.200 General**

- (a) The approved performance data in the AFM shall be supplemented as necessary with other data if the approved performance data in the AFM is insufficient in respect of items such as:
 - (1) accounting for reasonably expected adverse operating conditions such as take-off and landing on contaminated runways; and
 - (2) consideration of engine failure in all flight phases.
- (b) For wet and contaminated runways, performance data determined in accordance with applicable standards on certification of large aeroplanes or equivalent shall be used.
- (c) The use of other data referred to in (a) and equivalent requirements referred to in (b) shall be specified in the operations manual.

AMC1 CAT.POL.A.200 General**WET AND CONTAMINATED RUNWAY DATA**

If the performance data have been determined on the basis of a measured runway friction coefficient, the operator should use a procedure correlating the measured runway friction coefficient and the effective braking coefficient of friction of the aeroplane type over the required speed range for the existing runway conditions.

CAT.POLA.205 Take-off

- (a) The take-off mass shall not exceed the maximum take-off mass specified in the AFM for the pressure altitude and the ambient temperature at the aerodrome of departure.
- (b) The following requirements shall be met when determining the maximum permitted take-off mass:
 - (1) the accelerate-stop distance shall not exceed the accelerate-stop distance available (ASDA);
 - (2) the take-off distance shall not exceed the take-off distance available, with a clearway distance not exceeding half of the take-off run available (TORA);
 - (3) the take-off run shall not exceed the TORA;
 - (4) a single value of V_1 shall be used for the rejected and continued take-off; and
 - (5) on a wet or contaminated runway, the take-off mass shall not exceed that permitted for a take-off on a dry runway under the same conditions.
- (c) When showing compliance with (b), the following shall be taken into account:
 - (1) the pressure altitude at the aerodrome;
 - (2) the ambient temperature at the aerodrome;
 - (3) the runway surface condition and the type of runway surface;
 - (4) the runway slope in the direction of take-off;
 - (5) not more than 50 % of the reported headwind component or not less than 150 % of the reported tailwind component; and
 - (6) the loss, if any, of runway length due to alignment of the aeroplane prior to take-off.

AMC1 CAT.POLA.205 Take-off

LOSS OF RUNWAY LENGTH DUE TO ALIGNMENT

- (a) The length of the runway that is declared for the calculation of take-off distance available (TODA), accelerate-stop distance available (ASDA) and take-off run available (TORA) does not account for line-up of the aeroplane in the direction of take-off on the runway in use. This alignment distance depends on the aeroplane geometry and access possibility to the runway in use. Accountability is usually required for a 90°-taxiway entry to the runway and 180°-turnaround on the runway. There are two distances to be considered:
 - (1) the minimum distance of the main wheels from the start of the runway for determining TODA and TORA, 'L'; and
 - (2) the minimum distance of the most forward wheel(s) from the start of the runway for determining ASDA, 'N'.

Figure 1

Line-up of the aeroplane in the direction of take-off — L and N

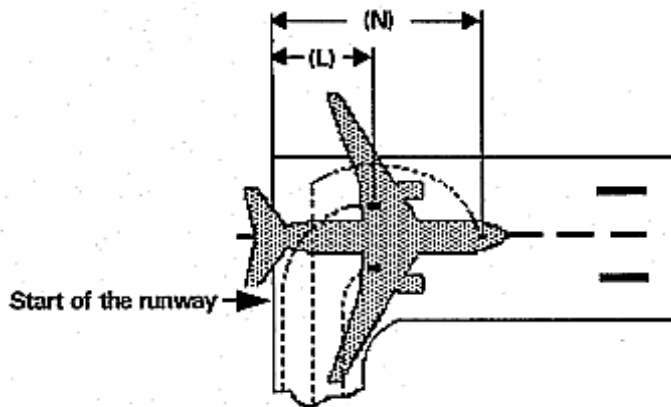

Where the aeroplane manufacturer does not provide the appropriate data, the calculation method given in (b) should be used to determine the alignment distance.

(b) Alignment distance calculation

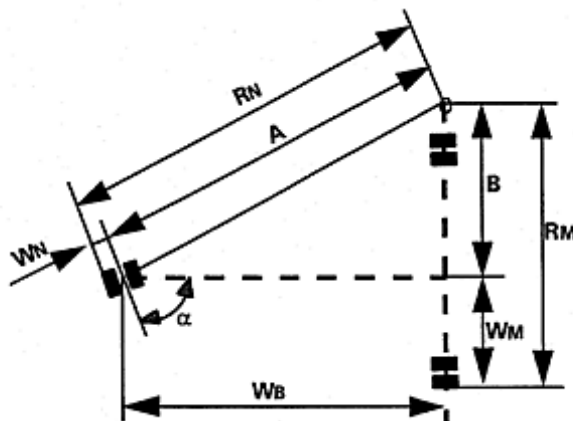

The distances mentioned in (a)(1) and (a)(2) are:

	90° entry	180° turnaround
L=	RM + X	RN + Y
N=	RM + X + WB	RN + Y + WB

where:

$$RN = A + WN = WB/\cos(90^\circ - \alpha) + WN$$

$$RM = B + WM = WB \tan(90^\circ - \alpha) + WM$$

X = safety distance of outer main wheel during turn to the edge of the runway

Y = safety distance of outer nose wheel during turn to the edge of the runway

Note: Minimum edge safety distances for X and Y are specified in FAA AC 150/5300-13 and ICAO Annex 14, 3.8.3

RN = radius of turn of outer nose wheel

RM = radius of turn of outer main wheel

WN = distance from aeroplane centre-line to outer nose wheel

WM = distance from aeroplane centre-line to outer main wheel

WB = wheel base

α = steering angle.

GM1 CAT.POLA.205 Take-off

RUNWAY SURFACE CONDITION

- (a) Operation on runways contaminated with water, slush, snow or ice implies uncertainties with regard to runway friction and contaminant drag and, therefore, to the achievable performance and control of the aeroplane during take-off, since the actual conditions may not completely match the assumptions on which the performance information is based. In the case of a contaminated runway, the first option for the commander is to wait until the runway is cleared. If this is impracticable, he/she may consider a take-off, provided that he/she has applied the applicable performance adjustments, and any further safety measures he/she considers justified under the prevailing conditions.
- (b) An adequate overall level of safety will only be maintained if operations in accordance with AMC 25.1591 or equivalent are limited to rare occasions. Where the frequency of such operations on contaminated runways is not limited to rare occasions, the operator should provide additional measures ensuring an equivalent level of safety. Such measures could include special crew training, additional distance factoring and more restrictive wind limitations.

CAT.POLA.210 Take-off obstacle clearance

- (a) The net take-off flight path shall be determined in such a way that the aeroplane clears all obstacles by a vertical distance of at least 35 ft or by a horizontal distance of at least 90 m plus $0,125 \times D$, where D is the horizontal distance the aeroplane has travelled from the end of the take-off distance available (TODA) or the end of the take-off distance if a turn is scheduled before the end of the TODA. For aeroplanes with a wingspan of less than 60 m, a horizontal obstacle clearance of half the aeroplane wingspan plus 60 m, plus $0,125 \times D$ may be used.
- (b) When showing compliance with (a):
- (1) The following items shall be taken into account:
 - (i) the mass of the aeroplane at the commencement of the take-off run;
 - (ii) the pressure altitude at the aerodrome;
 - (iii) the ambient temperature at the aerodrome; and
 - (iv) not more than 50 % of the reported headwind component or not less than 150 % of the reported tailwind component.
 - (2) Track changes shall not be allowed up to the point at which the net take-off flight path has achieved a height equal to one half the wingspan but not less than 50 ft above the elevation of the end of the TORA. Thereafter, up to a height of 400 ft it is assumed that the aeroplane is banked by no more than 15°. Above 400 ft height bank angles greater than 15°, but not more than 25° may be scheduled.
 - (3) Any part of the net take-off flight path in which the aeroplane is banked by more than 15° shall clear all obstacles within the horizontal distances specified in (a), (b)(6) and (b)(7) by a vertical distance of at least 50 ft.
 - (4) Operations that apply increased bank angles of not more than 20° between 200 ft and 400 ft, or not more than 30° above 400 ft, shall be carried out in accordance with CAT.POLA.240.
 - (5) Adequate allowance shall be made for the effect of bank angle on operating speeds and flight path including the distance increments resulting from increased operating speeds.
 - (6) For cases where the intended flight path does not require track changes of more than 15°, the operator does not need to consider those obstacles that have a lateral distance greater than:
 - (i) 300 m, if the pilot is able to maintain the required navigational accuracy through the obstacle accountability area; or
 - (ii) 600 m, for flights under all other conditions.
 - (7) For cases where the intended flight path requires track changes of more than 15°, the operator does not need to consider those obstacles that have a lateral distance greater than:
 - (i) 600 m, if the pilot is able to maintain the required navigational accuracy through the obstacle accountability area; or
 - (ii) 900 m, for flights under all other conditions.
- (c) The operator shall establish contingency procedures to satisfy the requirements in (a) and (b) and to provide a safe route, avoiding obstacles, to enable the aeroplane to either comply with the en-route requirements of CAT.POLA.215, or land at either the aerodrome of departure or at a take-off alternate aerodrome.

AMC1 CAT.POLA.210 Take-off obstacle clearance

TAKE-OFF OBSTACLE CLEARANCE

- (a) In accordance with the definitions used in preparing the take-off distance and take-off flight path data provided in the AFM:
- (1) The net take-off flight path is considered to begin at a height of 35 ft above the runway or clearway at the end of the take-off distance determined for the aeroplane in accordance with (b) below.
 - (2) The take-off distance is the longest of the following distances:
 - (i) 115 % of the distance with all engines operating from the start of the take-off to the point at which the aeroplane is 35 ft above the runway or clearway;
 - (ii) the distance from the start of the take-off to the point at which the aeroplane is 35 ft above the runway or clearway assuming failure of the critical engine occurs at the point corresponding to the decision speed (V_1) for a dry runway; or
 - (iii) if the runway is wet or contaminated, the distance from the start of the take-off to the point at which the aeroplane is 15 ft above the runway or clearway assuming failure of the critical engine occurs at the point corresponding to the decision speed (V_1) for a wet or contaminated runway.
- (b) The net take-off flight path, determined from the data provided in the AFM in accordance with (a)(1) and (a)(2), should clear all relevant obstacles by a vertical distance of 35 ft. When taking off on a wet or contaminated runway and an engine failure occurs at the point corresponding to the decision speed (V_1) for a wet or contaminated runway, this implies that the aeroplane can initially be as much as 20 ft below the net take-off flight path in accordance with (a) and, therefore, may clear close-in obstacles by only 15 ft. When taking off on wet or contaminated runways, the operator should exercise special care with respect to obstacle assessment, especially if a take-off is obstacle-limited and the obstacle density is high.

AMC2 CAT.POLA.210 Take-off obstacle clearance

EFFECT OF BANK ANGLES

- (a) The AFM generally provides a climb gradient decrement for a 15° bank turn. For bank angles of less than 15°, a proportionate amount should be applied unless the manufacturer or AFM has provided other data.
- (b) Unless otherwise specified in the AFM or other performance or operating manuals from the manufacturer, acceptable adjustments to assure adequate stall margins and gradient corrections are provided by the following table:

Table 1

Effect of bank angles

Bank	Speed	Gradient correction
15°	V ₂	1 x AFM 15° gradient loss
20°	V ₂ + 5 kt	2 x AFM 15° gradient loss
25°	V ₂ + 10 kt	3 x AFM 15° gradient loss

AMC3 CAT.POLA.210 Take-off obstacle clearance

REQUIRED NAVIGATIONAL ACCURACY

(a) Navigation systems

The obstacle accountability semi-widths of 300 m and 600 m may be used if the navigation system under OEI conditions provides a two standard deviation accuracy of 150 m and 300 m respectively.

(b) Visual course guidance

- (1) The obstacle accountability semi-widths of 300 m and 600 m may be used where navigational accuracy is ensured at all relevant points on the flight path by use of external references. These references may be considered visible from the flight crew compartment if they are situated more than 45° either side of the intended track and with a depression of not greater than 20° from the horizontal.
- (2) For visual course guidance navigation, the operator should ensure that the weather conditions prevailing at the time of operation, including ceiling and visibility, are such that the obstacle and/or ground reference points can be seen and identified. The operations manual should specify, for the aerodrome(s) concerned, the minimum weather conditions which enable the flight crew to continuously determine and maintain the correct flight path with respect to ground reference points, so as to provide a safe clearance with respect to obstructions and terrain as follows:
 - (i) the procedure should be well-defined with respect to ground reference points so that the track to be flown can be analysed for obstacle clearance requirements;
 - (ii) the procedure should be within the capabilities of the aeroplane with respect to forward speed, bank angle and wind effects;
 - (iii) a written and/or pictorial description of the procedure should be provided for crew use; and
 - (iv) the limiting environmental conditions (such as wind, the lowest cloud base, ceiling, visibility, day/night, ambient lighting, obstruction lighting) should be specified.

GM1 CAT.POLA.210 Take-off obstacle clearance

CONTINGENCY PROCEDURES FOR OBSTACLES CLEARANCES

If compliance with CAT.POLA.210 is based on an engine failure route that differs from the all engine departure route or SID normal departure, a 'deviation point' can be identified where the engine failure route deviates from the normal departure route. Adequate obstacle clearance along the normal departure route with failure of the critical engine at the deviation point will normally be available.

However, in certain situations the obstacle clearance along the normal departure route may be marginal and should be checked to ensure that, in case of an engine failure after the deviation point, a flight can safely proceed along the normal departure route.

CAT.POLA.215 En-route — one-engine-inoperative (OEI)

- (a) The OEI en-route net flight path data shown in the AFM, appropriate to the meteorological conditions expected for the flight, shall allow demonstration of compliance with (b) or (c) at all points along the route. The net flight path shall have a positive gradient at 1500 ft above the aerodrome where the landing is assumed to be made after engine failure. In meteorological conditions requiring the operation of ice protection systems, the effect of their use on the net flight path shall be taken into account.
- (b) The gradient of the net flight path shall be positive at least 1 000 ft above all terrain and obstructions along the route within 9,3 km (5 NM) on either side of the intended track.
- (c) The net flight path shall permit the aeroplane to continue flight from the cruising altitude to an aerodrome where a landing can be made in accordance with CAT.POLA.225 or CAT.POLA.230, as appropriate. The net flight path shall clear vertically, by at least 2 000 ft, all terrain and obstructions along the route within 9,3 km (5 NM) on either side of the intended track in accordance with the following:
- (1) the engine is assumed to fail at the most critical point along the route;
 - (2) account is taken of the effects of winds on the flight path;
 - (3) fuel jettisoning is permitted to an extent consistent with reaching the aerodrome with the required fuel reserves, if a safe procedure is used; and
 - (4) the aerodrome where the aeroplane is assumed to land after engine failure shall meet the following criteria:
 - (i) the performance requirements at the expected landing mass are met; and
 - (ii) weather reports and/or forecasts and field condition reports indicate that a safe landing can be accomplished at the estimated time of landing.
- (d) The operator shall increase the width margins of (b) and (c) to 18,5 km (10 NM) if the navigational accuracy does not meet at least required navigation performance 5 (RNP5).

AMC1 CAT.POLA.215 En-route – one-engine-inoperative (OEI)

ROUTE ANALYSIS

- (a) The high terrain or obstacle analysis required should be carried out by a detailed analysis of the route.
- (b) A detailed analysis of the route should be made using contour maps of the high terrain and plotting the highest points within the prescribed corridor's width along the route. The next step is to determine whether it is possible to maintain level flight with OEI 1 000 ft above the highest point of the crossing. If this is not possible, or if the associated weight penalties are unacceptable, a drift down procedure should be worked out, based on engine failure at the most critical point and clearing critical obstacles during the drift down by at least 2 000 ft. The minimum cruise altitude is determined by the intersection of the two drift down paths, taking into account allowances for decision making (see Figure 1). This method is time-consuming and requires the availability of detailed terrain maps.
- (c) Alternatively, the published minimum flight altitudes (MEA or minimum off-route altitude (MORA)) should be used for determining whether OEI level flight is feasible at the minimum flight altitude, or if it is necessary to use the published minimum flight altitudes as the basis for the drift down construction (see Figure 1). This procedure avoids a detailed high terrain contour analysis, but could be more penalising than taking the actual terrain profile into account as in (b).

- (d) In order to comply with CAT.POL.A.215 (c), one means of compliance is the use of MORA and, with CAT.POL.A.215 (d), MEA provided that the aeroplane meets the navigational equipment standard assumed in the definition of MEA.

Figure 1

Intersection of the two drift down paths

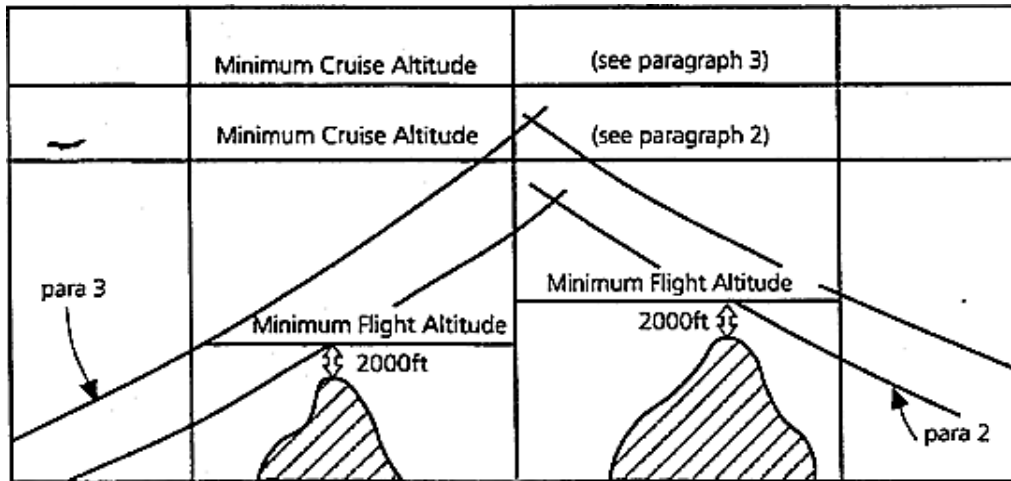

Note: MEA or MORA normally provide the required 2 000 ft obstacle clearance for drift down. However, at and below 6 000 ft altitude, MEA and MORA cannot be used directly as only 1 000 ft clearance is ensured.

CAT.POLA.220 En-route — aeroplanes with three or more engines, two engines inoperative

- (a) At no point along the intended track shall an aeroplane having three or more engines be more than 90 minutes, at the all-engines long range cruising speed at standard temperature in still air, away from an aerodrome at which the performance requirements applicable at the expected landing mass are met, unless it complies with (b) to (f).
- (b) The two-engines-inoperative en-route net flight path data shall allow the aeroplane to continue the flight, in the expected meteorological conditions, from the point where two engines are assumed to fail simultaneously to an aerodrome at which it is possible to land and come to a complete stop when using the prescribed procedure for a landing with two engines inoperative. The net flight path shall clear vertically, by at least 2 000 ft, all terrain and obstructions along the route within 9,3 km (5 NM) on either side of the intended track. At altitudes and in meteorological conditions requiring ice protection systems to be operable, the effect of their use on the net flight path data shall be taken into account. If the navigational accuracy does not meet at least RNP5, the operator shall increase the width margin given above to 18,5 km (10 NM).
- (c) The two engines shall be assumed to fail at the most critical point of that portion of the route where the aeroplane is more than 90 minutes, at the all-engines long range cruising speed at standard temperature in still air, away from an aerodrome at which the performance requirements applicable at the expected landing mass are met.
- (d) The net flight path shall have a positive gradient at 1 500 ft above the aerodrome where the landing is assumed to be made after the failure of two engines.
- (e) Fuel jettisoning shall be permitted to an extent consistent with reaching the aerodrome with the required fuel reserves, if a safe procedure is used.
- (f) The expected mass of the aeroplane at the point where the two engines are assumed to fail shall not be less than that which would include sufficient fuel to proceed to an aerodrome where the landing is assumed to be made, and to arrive there at least 1 500 ft directly over the landing area and thereafter to fly level for 15 minutes.

CAT.POLA.225 Landing — destination and alternate aerodromes

- (a) The landing mass of the aeroplane determined in accordance with CAT.POLA.105(a) shall not exceed the maximum landing mass specified for the altitude and the ambient temperature expected for the estimated time of landing at the destination aerodrome and alternate aerodrome.

AMC1 CAT.POLA.225 Landing — destination and alternate aerodromes

ALTITUDE MEASURING

The operator should use either pressure altitude or geometric altitude for its operation and this should be reflected in the operations manual.

AMC2 CAT.POLA.225 Landing — destination and alternate aerodromes

MISSED APPROACH

- (a) For instrument approaches with a missed approach climb gradient greater than 2.5 %, the operator should verify that the expected landing mass of the aeroplane allows for a missed approach with a climb gradient equal to or greater than the applicable missed approach gradient in the OEI missed approach configuration and at the associated speed.

- (b) For instrument approaches with DH below 200 ft, the operator should verify that the expected landing mass of the aeroplane allows a missed approach gradient of climb, with the critical engine failed and with the speed and configuration used for a missed approach of at least 2.5 %, or the published gradient, whichever is greater.

GM1 CAT.POLA.225 Landing — destination and alternate aerodromes**MISSED APPROACH GRADIENT**

- (a) Where an aeroplane cannot achieve the missed approach gradient specified in AMC2 CAT.POLA.225, when operating at or near maximum certificated landing mass and in engine-out conditions, the operator has the opportunity to propose an alternative means of compliance to the competent authority demonstrating that a missed approach can be executed safely taking into account appropriate mitigating measures.
- (b) The proposal for an alternative means of compliance may involve the following:
- (1) considerations to mass, altitude and temperature limitations and wind for the missed approach;
 - (2) a proposal to increase the DA/H or MDA/H; and
 - (3) a contingency procedure ensuring a safe route and avoiding obstacles.

CAT.POLA.230 Landing — dry runways

- (a) The landing mass of the aeroplane determined in accordance with CAT.POLA.105(a) for the estimated time of landing at the destination aerodrome and at any alternate aerodrome shall allow a full stop landing from 50 ft above the threshold:
 - (1) for turbo-jet powered aeroplanes, within 60 % of the landing distance available (LDA); and
 - (2) for turbo-propeller powered aeroplanes, within 70 % of the LDA.
- (b) For steep approach operations, the operator shall use the landing distance data factored in accordance with (a), based on a screen height of less than 60 ft, but not less than 35 ft, and shall comply with CAT.POLA.245.
- (c) For short landing operations, the operator shall use the landing distance data factored in accordance with (a) and shall comply with CAT.POLA.250.
- (d) When determining the landing mass, the operator shall take the following into account:
 - (1) the altitude at the aerodrome;
 - (2) not more than 50 % of the headwind component or not less than 150 % of the tailwind component; and
 - (3) the runway slope in the direction of landing if greater than ± 2 %.
- (e) For dispatching the aeroplane it shall be assumed that:
 - (1) the aeroplane will land on the most favourable runway, in still air; and
 - (2) the aeroplane will land on the runway most likely to be assigned, considering the probable wind speed and direction, the ground handling characteristics of the aeroplane and other conditions such as landing aids and terrain.
- (f) If the operator is unable to comply with (e)(1) for a destination aerodrome having a single runway where a landing depends upon a specified wind component, the aeroplane may be dispatched if two alternate aerodromes are designated that permit full compliance with (a) to (e). Before commencing an approach to land at the destination aerodrome, the commander shall check that a landing can be made in full compliance with (a) to (d) and CAT.POLA.225.
- (g) If the operator is unable to comply with (e)(2) for the destination aerodrome, the aeroplane shall be only dispatched if an alternate aerodrome is designated that allows full compliance with (a) to (e).

AMC1 CAT.POLA.230 Landing — dry runways**FACTORING OF AUTOMATIC LANDING DISTANCE PERFORMANCE DATA**

In those cases where the landing requires the use of an automatic landing system, and the distance published in the AFM includes safety margins equivalent to those contained in CAT.POLA.230 (a)(1) and CAT.POLA.235, the landing mass of the aeroplane should be the lesser of:

- (a) the landing mass determined in accordance with CAT.POLA.230 (a)(1) or CAT.POLA.235 as appropriate; or
- (b) the landing mass determined for the automatic landing distance for the appropriate surface condition, as given in the AFM or equivalent document. Increments due to system features such as beam location or elevations, or procedures such as use of overspeed, should also be included.

GM1 CAT.POLA.230 Landing — dry runways

LANDING MASS

CAT.POLA.230 establishes two considerations in determining the maximum permissible landing mass at the destination and alternate aerodromes:

- (a) Firstly, the aeroplane mass will be such that on arrival the aeroplane can be landed within 60 % or 70 % (as applicable) of the landing distance available (LDA) on the most favourable (normally the longest) runway in still air. Regardless of the wind conditions, the maximum landing mass for an aerodrome/aeroplane configuration at a particular aerodrome cannot be exceeded.
- (b) Secondly, consideration should be given to anticipated conditions and circumstances. The expected wind, or ATC and noise abatement procedures, may indicate the use of a different runway. These factors may result in a lower landing mass than that permitted under (a), in which case dispatch should be based on this lesser mass.
- (c) The expected wind referred to in (b) is the wind expected to exist at the time of arrival.

CAT.POLA.235 Landing — wet and contaminated runways

- (a) When the appropriate weather reports and/or forecasts indicate that the runway at the estimated time of arrival may be wet, the LDA shall be at least 115 % of the required landing distance, determined in accordance with CAT.POLA.230.
- (b) When the appropriate weather reports and/or forecasts indicate that the runway at the estimated time of arrival may be contaminated, the LDA shall be at least the landing distance determined in accordance with (a), or at least 115 % of the landing distance determined in accordance with approved contaminated landing distance data or equivalent, whichever is greater. The operator shall specify in the operations manual if equivalent landing distance data are to be applied.
- (c) A landing distance on a wet runway shorter than that required by (a), but not less than that required by CAT.POLA.230(a), may be used if the AFM includes specific additional information about landing distances on wet runways.
- (d) A landing distance on a specially prepared contaminated runway shorter than that required by (b), but not less than that required by CAT.POLA.230(a), may be used if the AFM includes specific additional information about landing distances on contaminated runways.
- (e) For (b), (c) and (d), the criteria of CAT.POLA.230 shall be applied accordingly, except that CAT.POLA.230(a) shall not be applied to (b) above.

CAT.POLA.240 Approval of operations with increased bank angles

- (a) Operations with increased bank angles require prior approval by the competent authority.
- (b) To obtain the approval, the operator shall provide evidence that the following conditions are met:
 - (1) the AFM contains approved data for the required increase of operating speed and data to allow the construction of the flight path considering the increased bank angles and speeds;
 - (2) visual guidance is available for navigation accuracy;
 - (3) weather minima and wind limitations are specified for each runway; and
 - (4) the flight crew has obtained adequate knowledge of the route to be flown and of the procedures to be used in accordance with Subpart FC of Part-ORO.

CAT.POLA.245 Approval of steep approach operations

- (a) Steep approach operations using glideslope angles of 4,5° or more and with screen heights of less than 60 ft, but not less than 35 ft, require prior approval by the competent authority.
- (b) To obtain the approval, the operator shall provide evidence that the following conditions are met:
 - (1) the AFM states the maximum approved glideslope angle, any other limitations, normal, abnormal or emergency procedures for the steep approach as well as amendments to the field length data when using steep approach criteria;
 - (2) for each aerodrome at which steep approach operations are to be conducted:
 - (i) a suitable glide path reference system comprising at least a visual glide path indicating system shall be available;
 - (ii) weather minima shall be specified; and
 - (iii) the following items shall be taken into consideration:
 - (A) the obstacle situation;

- (B) the type of glide path reference and runway guidance;
- (C) the minimum visual reference to be required at decision height (DH) and MDA;
- (D) available airborne equipment;
- (E) pilot qualification and special aerodrome familiarisation;
- (F) AFM limitations and procedures; and
- (G) missed approach criteria.

CAT.POLA.250 Approval of short landing operations

- (a) Short landing operations require prior approval by the competent authority.
- (b) To obtain the approval, the operator shall provide evidence that the following conditions are met:
 - (1) the distance used for the calculation of the permitted landing mass may consist of the usable length of the declared safe area plus the declared LDA;
 - (2) the State of the aerodrome has determined a public interest and operational necessity for the operation, either due to the remoteness of the aerodrome or to physical limitations relating to extending the runway;
 - (3) the vertical distance between the path of the pilot's eye and the path of the lowest part of the wheels, with the aeroplane established on the normal glide path, does not exceed 3 m;
 - (4) RVR/VIS minimum shall not be less than 1 500 m and wind limitations are specified in the operations manual;
 - (5) minimum pilot experience, training and special aerodrome familiarisation requirements are specified and met;
 - (6) the crossing height over the beginning of the usable length of the declared safe area is 50 ft;
 - (7) the use of the declared safe area is approved by the State of the aerodrome;
 - (8) the usable length of the declared safe area does not exceed 90 m;
 - (9) the width of the declared safe area is not less than twice the runway width or twice the wing span, whichever is greater, centred on the extended runway centre line;
 - (10) the declared safe area is clear of obstructions or depressions that would endanger an aeroplane undershooting the runway and no mobile object is permitted on the declared safe area while the runway is being used for short landing operations;
 - (11) the slope of the declared safe area does not exceed 5 % upward nor 2 % downward in the direction of landing; and
 - (12) additional conditions, if specified by the competent authority, taking into account aeroplane type characteristics, orographic characteristics in the approach area, available approach aids and missed approach/balked landing considerations.

CHAPTER 3

Performance class B

CAT.POL.A.300 General

- (a) The operator shall not operate a single-engined aeroplane:
 - (1) at night; or
 - (2) in IMC except under special VFR.
- (b) The operator shall treat two-engined aeroplanes that do not meet the climb requirements of CAT.POL.A.340 as single-engined aeroplanes.

CAT.POL.A.305 Take-off

- (a) The take-off mass shall not exceed the maximum take-off mass specified in the AFM for the pressure altitude and the ambient temperature at the aerodrome of departure.
- (b) The unfactored take-off distance, specified in the AFM, shall not exceed:
 - (1) when multiplied by a factor of 1,25, the take-off run available (TORA); or
 - (2) when stop way and/or clearway is available, the following:
 - (i) the TORA;
 - (ii) when multiplied by a factor of 1,15, the take-off distance available (TODA); or
 - (iii) when multiplied by a factor of 1,3, the ASDA.
- (c) When showing compliance with (b), the following shall be taken into account:
 - (1) the mass of the aeroplane at the commencement of the take-off run;
 - (2) the pressure altitude at the aerodrome;
 - (3) the ambient temperature at the aerodrome;
 - (4) the runway surface condition and the type of runway surface;
 - (5) the runway slope in the direction of take-off; and
 - (6) not more than 50 % of the reported headwind component or not less than 150 % of the reported tailwind component.

AMC1 CAT.POL.A.305 Take-off

RUNWAY SURFACE CONDITION

- (a) Unless otherwise specified in the AFM or other performance or operating manuals from the manufacturer, the variables affecting the take-off performance and the associated factors that should be applied to the AFM data are shown in Table 1 below. They should be applied in addition to the operational factors as prescribed in CAT.POL.A.305.

Table 1

Runway surface condition — Variables

Surface type	Condition	Factor
Grass (on firm soil)	Dry	1.2
up to 20 cm long	Wet	1.3
Paved	Wet	1.0

- (b) The soil should be considered firm when there are wheel impressions but no rutting.
- (c) When taking off on grass with a single-engined aeroplane, care should be taken to assess the rate of acceleration and consequent distance increase.
- (d) When making a rejected take-off on very short grass that is wet and with a firm subsoil, the surface may be slippery, in which case the distances may increase significantly.

AMC2 CAT.POLA.305 Take-off

RUNWAY SLOPE

Unless otherwise specified in the AFM, or other performance or operating manuals from the manufacturer, the take-off distance should be increased by 5 % for each 1 % of upslope except that correction factors for runways with slopes in excess of 2 % should only be applied when the operator has demonstrated to the competent authority that the necessary data in the AFM or the operations manual contain the appropriated procedures and the crew is trained to take-off in runway with slopes in excess of 2 %.

GM1 CAT.POLA.305 Take-off

RUNWAY SURFACE CONDITION

- (a) Due to the inherent risks, operations from contaminated runways are inadvisable, and should be avoided whenever possible. Therefore, it is advisable to delay the take-off until the runway is cleared.
- (b) Where this is impracticable, the commander should also consider the excess runway length available including the criticality of the overrun area.

CAT.POLA.310 Take-off obstacle clearance — multi-engined aeroplanes

- (a) The take-off flight path of aeroplanes with two or more engines shall be determined in such a way that the aeroplane clears all obstacles by a vertical distance of at least 50 ft, or by a horizontal distance of at least 90 m plus $0,125 \times D$, where D is the horizontal distance travelled by the aeroplane from the end of the TODA or the end of the take-off distance if a turn is scheduled before the end of the TODA, except as provided in (b) and (c). For aeroplanes with a wingspan of less than 60 m, a horizontal obstacle clearance of half the aeroplane wingspan plus 60 m plus $0,125 \times D$ may be used. It shall be assumed that:
- (1) the take-off flight path begins at a height of 50 ft above the surface at the end of the take-off distance required by CAT.POLA.305(b) and ends at a height of 1 500 ft above the surface;
 - (2) the aeroplane is not banked before the aeroplane has reached a height of 50 ft above the surface, and thereafter the angle of bank does not exceed 15°;
 - (3) failure of the critical engine occurs at the point on the all engine take-off flight path where visual reference for the purpose of avoiding obstacles is expected to be lost;
 - (4) the gradient of the take-off flight path from 50 ft to the assumed engine failure height is equal to the average all-engines gradient during climb and transition to the en-route configuration, multiplied by a factor of 0,77; and
 - (5) the gradient of the take-off flight path from the height reached in accordance with (a)(4) to the end of the take-off flight path is equal to the OEI en-route climb gradient shown in the AFM.
- (b) For cases where the intended flight path does not require track changes of more than 15°, the operator does not need to consider those obstacles that have a lateral distance greater than:
- (1) 300 m, if the flight is conducted under conditions allowing visual course guidance navigation, or if navigational aids are available enabling the pilot to maintain the intended flight path with the same accuracy; or
 - (2) 600 m, for flights under all other conditions.
- (c) For cases where the intended flight path requires track changes of more than 15°, the operator does not need to consider those obstacles that have a lateral distance greater than:
- (1) 600 m, for flights under conditions allowing visual course guidance navigation; or
 - (2) 900 m, for flights under all other conditions.
- (d) When showing compliance with (a) to (c), the following shall be taken into account:
- (1) the mass of the aeroplane at the commencement of the take-off run;
 - (2) the pressure altitude at the aerodrome;
 - (3) the ambient temperature at the aerodrome; and
 - (4) not more than 50 % of the reported headwind component or not less than 150 % of the reported tailwind component.
- (e) The requirements in (a)(3), (a)(4), (a)(5), (b)(2) and (c)(2) shall not be applicable to VFR operations by day.

AMC1 CAT.POLA.310 Take-off obstacle clearance — multi-engined aeroplanes

TAKE-OFF FLIGHT PATH — VISUAL COURSE GUIDANCE NAVIGATION

- (a) In order to allow visual course guidance navigation, the weather conditions prevailing at the time of operation, including ceiling and visibility, should be such that the obstacle and/or ground reference points can be seen and identified. For VFR operations by night, the visual course guidance should be considered available when the flight visibility is 1 500 m or more.
- (b) The operations manual should specify, for the aerodrome(s) concerned, the minimum weather conditions that enable the flight crew to continuously determine and maintain the correct flight path with respect to ground reference points so as to provide a safe clearance with respect to obstructions and terrain as follows:
- (1) the procedure should be well defined with respect to ground reference points so that the track to be flown can be analysed for obstacle clearance requirements;
 - (2) the procedure should be within the capabilities of the aeroplane with respect to forward speed, bank angle and wind effects;
 - (3) a written and/or pictorial description of the procedure should be provided for crew use; and
 - (4) the limiting environmental conditions should be specified (e.g. wind, cloud, visibility, day/night, ambient lighting, obstruction lighting).

AMC2 CAT.POLA.310 Take-off obstacle clearance — multi-engined aeroplanes

TAKE-OFF FLIGHT PATH CONSTRUCTION

- (a) For demonstrating that the aeroplane clears all obstacles vertically, a flight path should be constructed consisting of an all-engines segment to the assumed engine failure height, followed by an engine-out segment. Where the AFM does not contain the appropriate data, the approximation given in (b) may be used for the all-engines segment for an assumed engine failure height of 200 ft, 300 ft, or higher.
- (b) Flight path construction
- (1) All-engines segment (50 ft to 300 ft)

The average all-engines gradient for the all-engines flight path segment starting at an altitude of 50 ft at the end of the take-off distance ending at or passing through the 300 ft point is given by the following formula:

$$Y_{300} = \frac{0.57(Y_{ERC})}{1 + (V_{ERC}^2 - V_2^2) / 5647}$$

The factor of 0.77 as required by CAT.POLA.310 is already included where:

Y_{300} = average all-engines gradient from 50 ft to 300 ft;

Y_{ERC} = scheduled all engines en-route gross climb gradient;

V_{ERC} = en-route climb speed, all engines knots true airspeed (TAS);

V_2 = take-off speed at 50 ft, knots TAS;

- (2) All-engines segment (50 ft to 200 ft)

This may be used as an alternative to (b)(1) where weather minima permit. The average all-engines gradient for the all-engines flight path segment starting at an altitude of 50 ft at the end of the take-off distance ending at or passing through the 200 ft point is given by the following formula:

$$Y_{200} = \frac{0.51(Y_{ERC})}{1 + (V_{ERC}^2 - V_2^2) / 3388}$$

The factor of 0.77 as required by CAT.POLA.310 is already included where:

Y_{200} = average all-engines gradient from 50 ft to 200 ft;

Y_{ERC} = scheduled all engines en-route gross climb gradient;

V_{ERC} = en-route climb speed, all engines, knots TAS;

V_2 = take-off speed at 50 ft, knots TAS.

- (3) All-engines segment (above 300 ft)

The all-engines flight path segment continuing from an altitude of 300 ft is given by the AFM en-route gross climb gradient, multiplied by a factor of 0.77.

- (4) The OEI flight path

The OEI flight path is given by the OEI gradient chart contained in the AFM.

GM1 CAT.POLA.310 Take-off obstacle clearance — multi-engined aeroplanes

OBSTACLE CLEARANCE IN LIMITED VISIBILITY

- (a) Unlike the Certification Specifications applicable for performance class A aeroplanes, those for performance class B aeroplanes do not necessarily provide for engine failure in all phases of flight. It is accepted that performance accountability for engine failure need not be considered until a height of 300 ft is reached.
- (b) The weather minima given up to and including 300 ft imply that if a take-off is undertaken with minima below 300 ft, an OEI flight path should be plotted starting on the all-engines take-off flight path at the assumed engine failure height. This path should meet the vertical and lateral obstacle clearance specified in CAT.POLA.310. Should engine failure occur below this height, the associated visibility is taken as being the minimum that would enable the pilot to make, if necessary, a forced landing broadly in the direction of the take-off. At or below 300 ft, a circle and land procedure is extremely inadvisable. The weather minima provisions specify that, if the assumed engine failure height is more than 300 ft, the visibility should be at least 1 500 m and, to allow for manoeuvring, the same minimum visibility should apply whenever the obstacle clearance criteria for a continued take-off cannot be met.

GM2 CAT.POLA.310 Take-off obstacle clearance — multi-engined aeroplanes

TAKE-OFF FLIGHT PATH CONSTRUCTION

- (a) This GM provides examples to illustrate the method of take-off flight path construction given in AMC2 CAT.POLA.310. The examples are based on an aeroplane for which the AFM shows, at a given mass, altitude, temperature and wind component the following performance data:
- factored take-off distance – 1 000 m;

- take-off speed, $V_2 = 90$ kt;
 - en-route climb speed, $V_{ERC} = 120$ kt;
 - en-route all-engines climb gradient, $Y_{ERC} = 0.2$;
 - en-route OEI climb gradient, $Y_{ERC-1} = 0.032$.
- (1) Assumed engine failure height 300 ft

The average all-engines gradient from 50 ft to 300 ft may be read from Figure 1 or calculated with the following formula:

$$Y_{300} = \frac{0.57(Y_{ERC})}{1 + (V_{ERC}^2 - V_2^2) / 5647}$$

The factor of 0.77 as required by CAT.POL.A.310 is already included where:

Y_{300} = average all-engines gradient from 50 ft to 300 ft;

Y_{ERC} = scheduled all engines en-route gross climb gradient;

V_{ERC} = en-route climb speed, all engines knots TAS; and

V_2 = take-off speed at 50 ft, knots TAS.

Figure 1

Assumed engine failure height 300 ft

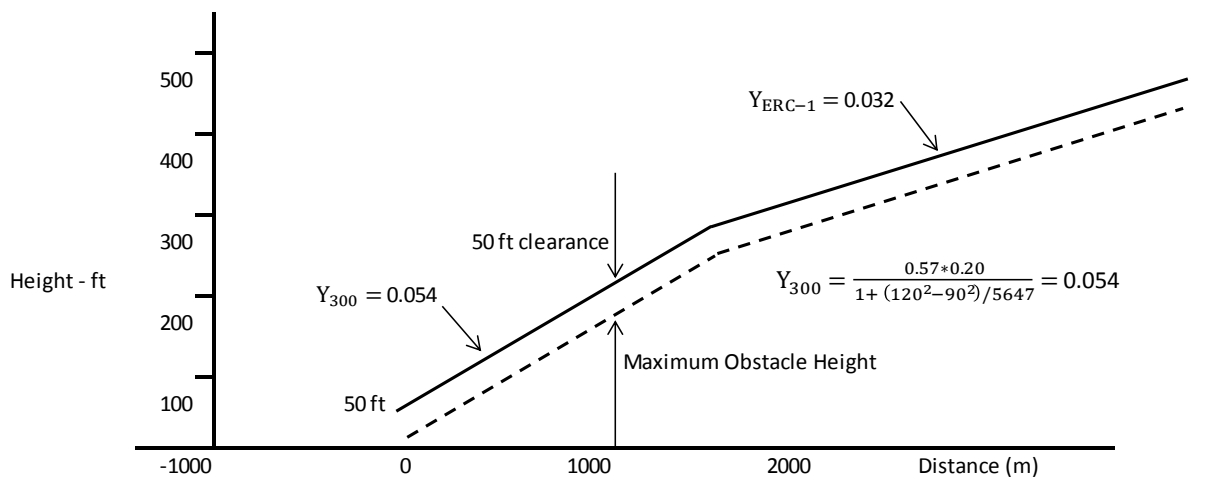

- (2) Assumed engine failure height 200 ft

The average all-engines gradient from 50 ft to 200 ft may be read from Figure 2 or calculated with the following formula:

$$Y_{200} = \frac{0.51(Y_{ERC})}{1 + (V_{ERC}^2 - V_2^2) / 3388}$$

The factor of 0.77 as required by CAT.POL.A.310 is already included where:

Y_{200} = average all-engines gradient from 50 ft to 200 ft;

Y_{ERC} = scheduled all engines en-route gross gradient;

V_{ERC} = en-route climb speed, all engines, knots TAS; and

V_2 = take-off speed at 50 ft, knots TAS.

Figure 2

Assumed engine failure height 200 ft

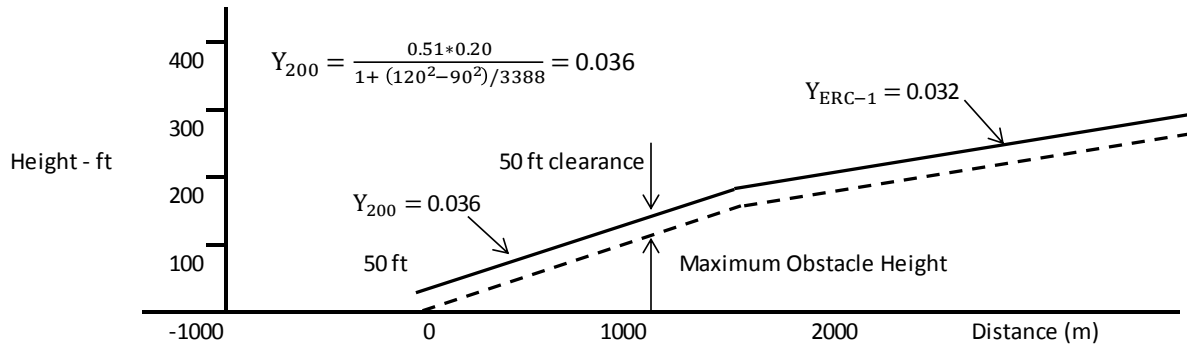

- (3) Assumed engine failure height less than 200 ft

Construction of a take-off flight path is only possible if the AFM contains the required flight path data.

- (4) Assumed engine failure height more than 300 ft

The construction of a take-off flight path for an assumed engine failure height of 400 ft is illustrated below.

Figure 3

Assumed engine failure height less than 200 ft

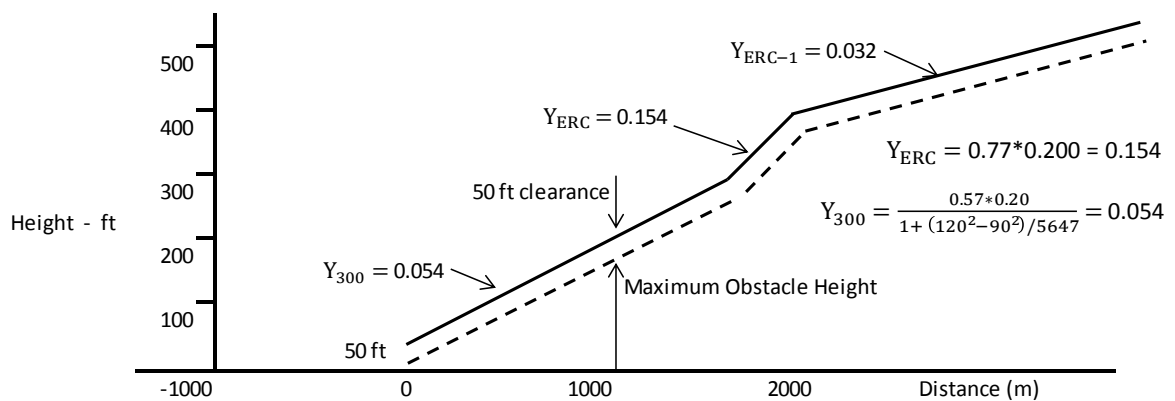

CAT.POLA.315 En-route — multi-engined aeroplanes

- (a) The aeroplane, in the meteorological conditions expected for the flight and in the event of the failure of one engine, with the remaining engines operating within the maximum continuous power conditions specified, shall be capable of continuing flight at or above the relevant minimum altitudes for safe flight stated in the operations manual to a point of 1 000 ft above an aerodrome at which the performance requirements can be met.
- (b) It shall be assumed that, at the point of engine failure:
 - (1) the aeroplane is not flying at an altitude exceeding that at which the rate of climb equals 300 ft per minute with all engines operating within the maximum continuous power conditions specified; and
 - (2) the en-route gradient with OEI shall be the gross gradient of descent or climb, as appropriate, respectively increased by a gradient of 0,5 %, or decreased by a gradient of 0,5 %.

GM1 CAT.POLA.315 En-route — multi-engined aeroplanes

CRUISING ALTITUDE

- (a) The altitude at which the rate of climb equals 300 ft per minute is not a restriction on the maximum cruising altitude at which the aeroplane can fly in practice, it is merely the maximum altitude from which the driftdown procedure can be planned to start.
- (b) Aeroplanes may be planned to clear en-route obstacles assuming a driftdown procedure, having first increased the scheduled en-route OEI descent data by 0.5 % gradient.

CAT.POLA.320 En-route — single-engined aeroplanes

- (a) In the meteorological conditions expected for the flight, and in the event of engine failure, the aeroplane shall be capable of reaching a place at which a safe forced landing can be made.
- (b) It shall be assumed that, at the point of engine failure:
 - (1) the aeroplane is not flying at an altitude exceeding that at which the rate of climb equals 300 ft per minute, with the engine operating within the maximum continuous power conditions specified; and
 - (2) the en-route gradient is the gross gradient of descent increased by a gradient of 0,5 %.

AMC1 CAT.POLA.320 En-route — single-engined aeroplanes

ENGINE FAILURE

CAT.POLA.320 (a) requires the operator to ensure that in the event of an engine failure, the aeroplane should be capable of reaching a point from which a safe forced landing can be made. Unless otherwise specified by the competent authority, this point should be 1 000 ft above the intended landing area.

GM1 CAT.POLA.320 En-route — single-engined aeroplanes

ENGINE FAILURE

- (a) In the event of an engine failure, single-engined aeroplanes have to rely on gliding to a point suitable for a safe forced landing. Such a procedure is clearly incompatible with flight above a cloud layer that extends below the relevant minimum safe altitude.
- (b) The operator should first increase the scheduled engine-inoperative gliding performance data by 0.5 % gradient when verifying the en-route clearance of obstacles and the ability to reach a suitable place for a forced landing.
- (c) The altitude at which the rate of climb equals 300 ft per minute is not a restriction on the maximum cruising altitude at which the aeroplane can fly in practice, it is merely the maximum altitude from which the engine-inoperative procedure can be planned to start.

CAT.POLA.325 Landing — destination and alternate aerodromes

The landing mass of the aeroplane determined in accordance with CAT.POLA.105(a) shall not exceed the maximum landing mass specified for the altitude and the ambient temperature expected at the estimated time of landing at the destination aerodrome and alternate aerodrome.

AMC1 CAT.POLA.325 Landing — destination and alternate aerodromes**ALTITUDE MEASURING**

The operator should use either pressure altitude or geometric altitude for its operation and this should be reflected in the operations manual.

CAT.POLA.330 Landing — dry runways

- (a) The landing mass of the aeroplane determined in accordance with CAT.POLA.105(a) for the estimated time of landing at the destination aerodrome and at any alternate aerodrome shall allow a full stop landing from 50 ft above the threshold within 70 % of the LDA taking into account:
- (1) the altitude at the aerodrome;
 - (2) not more than 50 % of the headwind component or not less than 150 % of the tailwind component;
 - (3) the runway surface condition and the type of runway surface; and
 - (4) the runway slope in the direction of landing.
- (b) For steep approach operations, the operator shall use landing distance data factored in accordance with (a) based on a screen height of less than 60 ft, but not less than 35 ft, and comply with CAT.POLA.345.
- (c) For short landing operations, the operator shall use landing distance data factored in accordance with (a) and comply with CAT.POLA.350.
- (d) For dispatching the aeroplane in accordance with (a) to (c), it shall be assumed that:
- (1) the aeroplane will land on the most favourable runway, in still air; and
 - (2) the aeroplane will land on the runway most likely to be assigned considering the probable wind speed and direction, the ground handling characteristics of the aeroplane and other conditions such as landing aids and terrain.
- (e) If the operator is unable to comply with (d)(2) for the destination aerodrome, the aeroplane shall only be dispatched if an alternate aerodrome is designated that permits full compliance with (a) to (d).

AMC1 CAT.POLA.330 Landing — dry runways

LANDING DISTANCE CORRECTION FACTORS

- (a) Unless otherwise specified in the AFM, or other performance or operating manuals from the manufacturers, the variable affecting the landing performance and the associated factor that should be applied to the AFM data are shown in the table below. It should be applied in addition to the operational factors as prescribed in CAT.POLA.330 (a).

Table 1

Landing distance correction factors

Surface type	Factor
Grass (on firm soil up to 20 cm long)	1.15

- (b) The soil should be considered firm when there are wheel impressions but no rutting.

AMC2 CAT.POLA.330 Landing — dry runways

RUNWAY SLOPE

Unless otherwise specified in the AFM, or other performance or operating manuals from the manufacturer, the landing distances required should be increased by 5 % for each 1 % of downslope.

GM1 CAT.POLA.330 Landing — dry runways

LANDING MASS

CAT.POLA.330 establishes two considerations in determining the maximum permissible landing mass at the destination and alternate aerodromes.

- (a) Firstly, the aeroplane mass will be such that on arrival the aeroplane can be landed within 70 % of the LDA on the most favourable (normally the longest) runway in still air. Regardless of the wind conditions, the maximum landing mass for an aerodrome/aeroplane configuration at a particular aerodrome cannot be exceeded.
- (b) Secondly, consideration should be given to anticipated conditions and circumstances. The expected wind, or ATC and noise abatement procedures, may indicate the use of a different runway. These factors may result in a lower landing mass than that permitted under (a), in which case dispatch should be based on this lesser mass.
- (c) The expected wind referred to in (b) is the wind expected to exist at the time of arrival.

CAT.POLA.335 Landing — wet and contaminated runways

- (a) When the appropriate weather reports and/or forecasts indicate that the runway at the estimated time of arrival may be wet, the LDA shall be equal to or exceed the required landing distance, determined in accordance with CAT.POLA.330, multiplied by a factor of 1,15.
- (b) When the appropriate weather reports and/or forecasts indicate that the runway at the estimated time of arrival may be contaminated, the landing distance shall not exceed the LDA. The operator shall specify in the operations manual the landing distance data to be applied.
- (c) A landing distance on a wet runway shorter than that required by (a), but not less than that required by CAT.POLA.330(a), may be used if the AFM includes specific additional information about landing distances on wet runways.

GM1 CAT.POLA.335 Landing — wet and contaminated runways

LANDING ON WET GRASS RUNWAYS

- (a) When landing on very short grass that is wet and with a firm subsoil, the surface may be slippery, in which case the distances may increase by as much as 60 % (1.60 factor).
- (b) As it may not be possible for a pilot to determine accurately the degree of wetness of the grass, particularly when airborne, in cases of doubt, the use of the wet factor (1.15) is recommended.

CAT.POLA.340 Take-off and landing climb requirements

The operator of a two-engined aeroplane shall fulfil the following take-off and landing climb requirements.

(a) Take-off climb**(1) All engines operating**

- (i) The steady gradient of climb after take-off shall be at least 4 % with:
 - (A) take-off power on each engine;
 - (B) the landing gear extended, except that if the landing gear can be retracted in not more than seven seconds, it may be assumed to be retracted;
 - (C) the wing flaps in the take-off position(s); and
 - (D) a climb speed not less than the greater of $1,1 V_{MC}$ (minimum control speed on or near ground) and $1,2 V_{S1}$ (stall speed or minimum steady flight speed in the landing configuration).

(2) OEI

- (i) The steady gradient of climb at an altitude of 400 ft above the take-off surface shall be measurably positive with:
 - (A) the critical engine inoperative and its propeller in the minimum drag position;
 - (B) the remaining engine at take-off power;
 - (C) the landing gear retracted;
 - (D) the wing flaps in the take-off position(s); and
 - (E) a climb speed equal to that achieved at 50 ft.
- (ii) The steady gradient of climb shall be not less than 0,75 % at an altitude of 1 500 ft above the take-off surface with:
 - (A) the critical engine inoperative and its propeller in the minimum drag position;
 - (B) the remaining engine at not more than maximum continuous power;
 - (C) the landing gear retracted;
 - (D) the wing flaps retracted; and
 - (E) a climb speed not less than $1,2 V_{S1}$.

(b) Landing climb**(1) All engines operating**

- (i) The steady gradient of climb shall be at least 2,5 % with:
 - (A) not more than the power or thrust that is available eight seconds after initiation of movement of the power controls from the minimum flight idle position;
 - (B) the landing gear extended;
 - (C) the wing flaps in the landing position; and
 - (D) a climb speed equal to V_{REF} (reference landing speed).

(2) OEI

- (i) The steady gradient of climb shall be not less than 0,75 % at an altitude of 1 500 ft above the landing surface with:
 - (A) the critical engine inoperative and its propeller in the minimum drag position;
 - (B) the remaining engine at not more than maximum continuous power;
 - (C) the landing gear retracted;
 - (D) the wing flaps retracted; and
 - (E) a climb speed not less than $1,2 V_{S1}$.

CAT.POL.A.345 Approval of steep approach operations

- (a) Steep approach operations using glideslope angles of $4,5^\circ$ or more and with screen heights of less than 60 ft, but not less than 35 ft, require prior approval by the competent authority.
- (b) To obtain the approval, the operator shall provide evidence that the following conditions are met:
 - (1) the AFM states the maximum approved glideslope angle, any other limitations, normal, abnormal or emergency procedures for the steep approach as well as amendments to the field length data when using steep approach criteria; and
 - (2) for each aerodrome at which steep approach operations are to be conducted:
 - (i) a suitable glide path reference system, comprising at least a visual glide path indicating system, is available;
 - (ii) weather minima are specified; and
 - (iii) the following items are taken into consideration:
 - (A) the obstacle situation;
 - (B) the type of glide path reference and runway guidance;
 - (C) the minimum visual reference to be required at DH and MDA;
 - (D) available airborne equipment;
 - (E) pilot qualification and special aerodrome familiarisation;
 - (F) AFM limitations and procedures; and
 - (G) missed approach criteria.

CAT.POL.A.350 Approval of short landing operations

- (a) Short landing operations require prior approval by the competent authority.
- (b) To obtain the approval, the operator shall provide evidence that the following conditions are met:
 - (1) the distance used for the calculation of the permitted landing mass may consist of the usable length of the declared safe area plus the declared LDA;
 - (2) the use of the declared safe area is approved by the State of the aerodrome;
 - (3) the declared safe area is clear of obstructions or depressions that would endanger an aeroplane undershooting the runway and no mobile object is permitted on the declared safe area while the runway is being used for short landing operations;
 - (4) the slope of the declared safe area does not exceed 5 % upward nor 2 % downward slope in the direction of landing;

-
- (5) the usable length of the declared safe area does not exceed 90 m;
 - (6) the width of the declared safe area is not less than twice the runway width, centred on the extended runway centreline;
 - (7) the crossing height over the beginning of the usable length of the declared safe area is not less than 50 ft;
 - (8) weather minima are specified for each runway to be used and are not less than the greater of VFR or NPA minima;
 - (9) pilot experience, training and special aerodrome familiarisation requirements are specified and met;
 - (10) additional conditions, if specified by the competent authority, taking into account the aeroplane type characteristics, orographic characteristics in the approach area, available approach aids and missed approach/balked landing considerations.

CHAPTER 4
Performance class C**CAT.POL.A.400 Take-off**

- (a) The take-off mass shall not exceed the maximum take-off mass specified in the AFM for the pressure altitude and the ambient temperature at the aerodrome of departure.
- (b) For aeroplanes that have take-off field length data contained in their AFM that do not include engine failure accountability, the distance from the start of the take-off roll required by the aeroplane to reach a height of 50 ft above the surface with all engines operating within the maximum take-off power conditions specified, when multiplied by a factor of either:
- (1) 1,33 for aeroplanes having two engines;
 - (2) 1,25 for aeroplanes having three engines; or
 - (3) 1,18 for aeroplanes having four engines,
- shall not exceed the take-off run available (TORA) at the aerodrome at which the take-off is to be made.
- (c) For aeroplanes that have take-off field length data contained in their AFM which accounts for engine failure, the following requirements shall be met in accordance with the specifications in the AFM:
- (1) the accelerate-stop distance shall not exceed the ASDA;
 - (2) the take-off distance shall not exceed the take-off distance available (TODA), with a clearway distance not exceeding half of the TORA;
 - (3) the take-off run shall not exceed the TORA;
 - (4) a single value of V_1 for the rejected and continued take-off shall be used; and
 - (5) on a wet or contaminated runway the take-off mass shall not exceed that permitted for a take-off on a dry runway under the same conditions.
- (d) The following shall be taken into account:
- (1) the pressure altitude at the aerodrome;
 - (2) the ambient temperature at the aerodrome;
 - (3) the runway surface condition and the type of runway surface;
 - (4) the runway slope in the direction of take-off;
 - (5) not more than 50 % of the reported headwind component or not less than 150 % of the reported tailwind component; and
 - (6) the loss, if any, of runway length due to alignment of the aeroplane prior to take-off.

AMC1 CAT.POL.A.400 Take-off**LOSS OF RUNWAY LENGTH DUE TO ALIGNMENT**

- (a) The length of the runway that is declared for the calculation of TODA, ASDA and TORA does not account for line-up of the aeroplane in the direction of take-off on the runway in use. This alignment distance depends on the aeroplane geometry and access possibility to the runway in

use. Accountability is usually required for a 90°-taxiway entry to the runway and 180°-turnaround on the runway. There are two distances to be considered:

- (1) the minimum distance of the main wheels from the start of the runway for determining TODA and TORA, 'L'; and
- (2) the minimum distance of the most forward wheel(s) from the start of the runway for determining ASDA, 'N'.

Figure 1

Line-up of the aeroplane in the direction of take-off — L and N

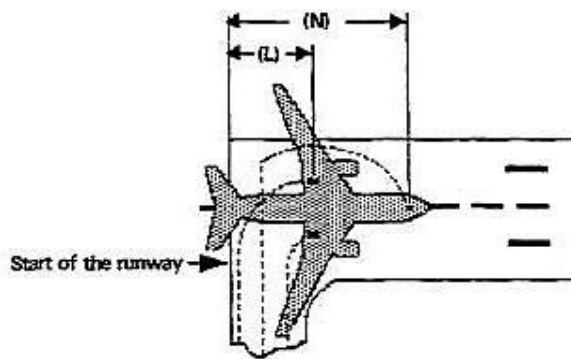

Where the aeroplane manufacturer does not provide the appropriate data, the calculation method given in (b) may be used to determine the alignment distance.

- (b) Alignment distance calculation

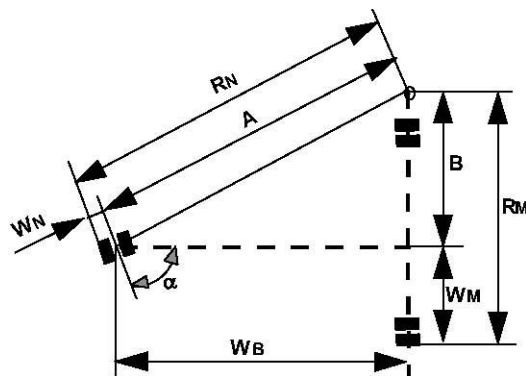

The distances mentioned in (a)(1) and (a)(2) above are:

	90°-entry	180°-turnaround
L =	RM + X	RN + Y
N =	RM + X + WB	RN + Y + WB

where:

$$RN = A + WN = \frac{WB}{\cos(90^\circ - \alpha)}$$

$$RM = B + WM = WB \tan(90^\circ - \alpha) + WM$$

X = safety distance of outer main wheel during turn to the edge of the runway

Y = safety distance of outer nose wheel during turn to the edge of the runway

Note: Minimum edge safety distances for X and Y are specified in FAA AC 150/5300-13 and ICAO Annex 14, 3.8.3

RN = radius of turn of outer nose wheel

RM = radius of turn of outer main wheel

WN = distance from aeroplane centre-line to outer nose wheel

WM = distance from aeroplane centre-line to outer main wheel

WM = wheel base

α = steering angle.

AMC2 CAT.POLA.400 Take-off

RUNWAY SLOPE

Unless otherwise specified in the AFM, or other performance or operating manuals from the manufacturers, the take-off distance should be increased by 5 % for each 1 % of upslope. However, correction factors for runways with slopes in excess of 2 % should only be applied when:

- (a) the operator has demonstrated to the competent authority that the necessary data in the AFM or the operations manual contain the appropriated procedures; and
- (b) the crew is trained to take-off on runways with slopes in excess of 2 %.

GM1 CAT.POLA.400 Take-off

RUNWAY SURFACE CONDITION

Operation on runways contaminated with water, slush, snow or ice implies uncertainties with regard to runway friction and contaminant drag and, therefore, to the achievable performance and control of the aeroplane during take-off, since the actual conditions may not completely match the assumptions on which the performance information is based. An adequate overall level of safety can, therefore, only be maintained if such operations are limited to rare occasions. In case of a contaminated runway, the first option for the commander is to wait until the runway is cleared. If this is impracticable, he/she may consider a take-off, provided that he/she has applied the applicable performance adjustments, and any further safety measures he/she considers justified under the prevailing conditions.

CAT.POL.A.405 Take-off obstacle clearance

- (a) The take-off flight path with OEI shall be determined such that the aeroplane clears all obstacles by a vertical distance of at least 50 ft plus $0,01 \times D$, or by a horizontal distance of at least 90 m plus $0,125 \times D$, where D is the horizontal distance the aeroplane has travelled from the end of the TODA. For aeroplanes with a wingspan of less than 60 m, a horizontal obstacle clearance of half the aeroplane wingspan plus 60 m plus $0,125 \times D$ may be used.
- (b) The take-off flight path shall begin at a height of 50 ft above the surface at the end of the take-off distance required by CAT.POL.A.400(b) or (c), as applicable, and end at a height of 1500 ft above the surface.
- (c) When showing compliance with (a), the following shall be taken into account:
- (1) the mass of the aeroplane at the commencement of the take-off run;
 - (2) the pressure altitude at the aerodrome;
 - (3) the ambient temperature at the aerodrome; and
 - (4) not more than 50 % of the reported headwind component or not less than 150 % of the reported tailwind component.
- (d) Track changes shall not be allowed up to that point of the take-off flight path where a height of 50 ft above the surface has been achieved. Thereafter, up to a height of 400 ft it is assumed that the aeroplane is banked by no more than 15°. Above 400 ft height bank angles greater than 15°, but not more than 25°, may be scheduled. Adequate allowance shall be made for the effect of bank angle on operating speeds and flight path, including the distance increments resulting from increased operating speeds.
- (e) For cases that do not require track changes of more than 15°, the operator does not need to consider those obstacles that have a lateral distance greater than:
- (1) 300 m, if the pilot is able to maintain the required navigational accuracy through the obstacle accountability area; or
 - (2) 600 m, for flights under all other conditions.
- (f) For cases that do require track changes of more than 15°, the operator does not need to consider those obstacles that have a lateral distance greater than:
- (1) 600 m, if the pilot is able to maintain the required navigational accuracy through the obstacle accountability area; or
 - (2) 900 m, for flights under all other conditions.
- (g) The operator shall establish contingency procedures to satisfy (a) to (f) and to provide a safe route, avoiding obstacles, to enable the aeroplane to either comply with the en-route requirements of CAT.POL.A.410, or land at either the aerodrome of departure or at a take-off alternate aerodrome.

AMC1 CAT.POL.A.405 Take-off obstacle clearance**EFFECT OF BANK ANGLES**

- (a) The AFM generally provides a climb gradient decrement for a 15° bank turn. Unless otherwise specified in the AFM or other performance or operating manuals from the manufacturer, acceptable adjustments to assure adequate stall margins and gradient corrections are provided by the following:

Table 1

Effect of bank angles

Bank	Speed	Gradient correction
15°	V ₂	1 x AFM 15° gradient loss
20°	V ₂ + 5 kt	2 x AFM 15° gradient loss
25°	V ₂ + 10 kt	3 x AFM 15° gradient loss

- (b) For bank angles of less than 15°, a proportionate amount may be applied, unless the manufacturer or AFM has provided other data.

AMC2 CAT.POLA.405 Take-off obstacle clearance

REQUIRED NAVIGATIONAL ACCURACY

- (a) Navigation systems

The obstacle accountability semi-widths of 300 m and 600 m may be used if the navigation system under OEI conditions provides a two-standard deviation accuracy of 150 m and 300 m respectively.

- (b) Visual course guidance

- (1) The obstacle accountability semi-widths of 300 m and 600 m may be used where navigational accuracy is ensured at all relevant points on the flight path by use of external references. These references may be considered visible from the flight crew compartment if they are situated more than 45° either side of the intended track and with a depression of not greater than 20° from the horizontal.
- (2) For visual course guidance navigation, the operator should ensure that the weather conditions prevailing at the time of operation, including ceiling and visibility, are such that the obstacle and/or ground reference points can be seen and identified. The operations manual should specify, for the aerodrome(s) concerned, the minimum weather conditions that enable the flight crew to continuously determine and maintain the correct flight path with respect to ground reference points, so as to provide a safe clearance with respect to obstructions and terrain as follows:
 - (i) the procedure should be well defined with respect to ground reference points so that the track to be flown can be analysed for obstacle clearance requirements;
 - (ii) the procedure should be within the capabilities of the aeroplane with respect to forward speed, bank angle and wind effects;
 - (iii) a written and/or pictorial description of the procedure should be provided for crew use; and
 - (iv) the limiting environmental conditions (such as wind, the lowest cloud base, ceiling, visibility, day/night, ambient lighting, obstruction lighting) should be specified.

CAT.POLA.410 En-route — all engines operating

- (a) In the meteorological conditions expected for the flight, at any point on its route or on any planned diversion therefrom, the aeroplane shall be capable of a rate of climb of at least 300 ft per minute with all engines operating within the maximum continuous power conditions specified at:
- (1) the minimum altitudes for safe flight on each stage of the route to be flown, or of any planned diversion therefrom, specified in or calculated from the information contained in the operations manual relating to the aeroplane; and
 - (2) the minimum altitudes necessary for compliance with the conditions prescribed in CAT.POLA.415 and 420, as appropriate.

CAT.POLA.415 En-route — OEI

- (a) In the meteorological conditions expected for the flight, in the event of any one engine becoming inoperative at any point on its route or on any planned diversion therefrom and with the other engine(s) operating within the maximum continuous power conditions specified, the aeroplane shall be capable of continuing the flight from the cruising altitude to an aerodrome where a landing can be made in accordance with CAT.POLA.430 or CAT.POLA.435, as appropriate. The aeroplane shall clear obstacles within 9,3 km (5 NM) either side of the intended track by a vertical interval of at least:
- (1) 1 000 ft, when the rate of climb is zero or greater; or
 - (2) 2 000 ft, when the rate of climb is less than zero.
- (b) The flight path shall have a positive slope at an altitude of 450 m (1 500 ft) above the aerodrome where the landing is assumed to be made after the failure of one engine.
- (c) The available rate of climb of the aeroplane shall be taken to be 150 ft per minute less than the gross rate of climb specified.
- (d) The width margins of (a) shall be increased to 18,5 km (10 NM) if the navigational accuracy does not meet at least RNP5.
- (e) Fuel jettisoning is permitted to an extent consistent with reaching the aerodrome with the required fuel reserves, if a safe procedure is used.

AMC1 CAT.POLA.415 En-route – OEI

ROUTE ANALYSIS

The high terrain or obstacle analysis should be carried out by making a detailed analysis of the route using contour maps of the high terrain, and plotting the highest points within the prescribed corridor width along the route. The next step is to determine whether it is possible to maintain level flight with OEI 1 000 ft above the highest point of the crossing. If this is not possible, or if the associated weight penalties are unacceptable, a drift down procedure must be evaluated, based on engine failure at the most critical point, and must show obstacle clearance during the drift down by at least 2 000 ft. The minimum cruise altitude is determined from the drift down path, taking into account allowances for decision making, and the reduction in the scheduled rate of climb (See Figure 1).

Figure 1

Intersection of the drift down paths

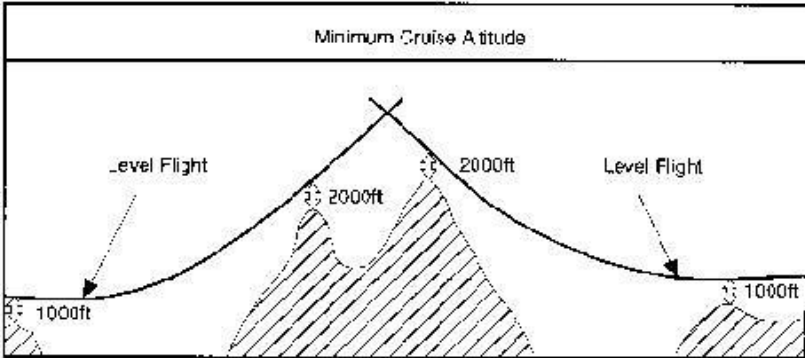

CAT.POLA.420 En-route — aeroplanes with three or more engines, two engines inoperative

- (a) At no point along the intended track shall an aeroplane having three or more engines be more than 90 minutes, at the all-engines long range cruising speed at standard temperature in still air, away from an aerodrome at which the performance requirements applicable at the expected landing mass are met, unless it complies with (b) to (e).
- (b) The two-engines-inoperative flight path shall permit the aeroplane to continue the flight, in the expected meteorological conditions, clearing all obstacles within 9,3 km (5 NM) either side of the intended track by a vertical interval of at least 2 000 ft, to an aerodrome at which the performance requirements applicable at the expected landing mass are met.
- (c) The two engines are assumed to fail at the most critical point of that portion of the route where the aeroplane is more than 90 minutes, at the all-engines long range cruising speed at standard temperature in still air, away from an aerodrome at which the performance requirements applicable at the expected landing mass are met.
- (d) The expected mass of the aeroplane at the point where the two engines are assumed to fail shall not be less than that which would include sufficient fuel to proceed to an aerodrome where the landing is assumed to be made, and to arrive there at an altitude of at least 450 m (1 500 ft) directly over the landing area and thereafter to fly level for 15 minutes.
- (e) The available rate of climb of the aeroplane shall be taken to be 150 ft per minute less than that specified.
- (f) The width margins of (b) shall be increased to 18,5 km (10 NM) if the navigational accuracy does not meet at least RNP5.
- (g) Fuel jettisoning is permitted to an extent consistent with reaching the aerodrome with the required fuel reserves, if a safe procedure is used.

CAT.POLA.425 Landing — destination and alternate aerodromes

The landing mass of the aeroplane determined in accordance with CAT.POLA.105(a) shall not exceed the maximum landing mass specified in the AFM for the altitude and, if accounted for in the AFM, the ambient temperature expected for the estimated time of landing at the destination aerodrome and alternate aerodrome.

AMC1 CAT.POLA.425 Landing — destination and alternate aerodromes**ALTITUDE MEASURING**

The operator should use either pressure altitude or geometric altitude for its operation and this should be reflected in the operations manual.

CAT.POL.A.430 Landing — dry runways

- (a) The landing mass of the aeroplane determined in accordance with CAT.POL.A.105(a) for the estimated time of landing at the destination aerodrome and any alternate aerodrome shall allow a full stop landing from 50 ft above the threshold within 70 % of the LDA taking into account:
- (1) the altitude at the aerodrome;
 - (2) not more than 50 % of the headwind component or not less than 150 % of the tailwind component;
 - (3) the type of runway surface; and
 - (4) the slope of the runway in the direction of landing.
- (b) For dispatching the aeroplane it shall be assumed that:
- (1) the aeroplane will land on the most favourable runway in still air; and
 - (2) the aeroplane will land on the runway most likely to be assigned considering the probable wind speed and direction, the ground handling characteristics of the aeroplane and other conditions such as landing aids and terrain.
- (c) If the operator is unable to comply with (b)(2) for the destination aerodrome, the aeroplane shall only be dispatched if an alternate aerodrome is designated that permits full compliance with (a) and (b).

AMC1 CAT.POL.A.430 Landing — dry runways

LANDING DISTANCE CORRECTION FACTORS

- (a) Unless otherwise specified in the AFM or other performance or operating manuals from the manufacturers, the variables affecting the landing performance and the associated factors to be applied to the AFM data are shown in the table below. It should be applied in addition to the factor specified in CAT.POL.A.430.

Table 1

Landing distance correction factor

Surface type	factor
Grass (on firm soil up to 20 cm long)	1.2

- (b) The soil should be considered firm when there are wheel impressions, but no rutting.

AMC2 CAT.POL.A.430 Landing — dry runways

RUNWAY SLOPE

Unless otherwise specified in the AFM, or other performance or operating manuals from the manufacturer, the landing distances required should be increased by 5 % for each 1 % of downslope.

GM1 CAT.POL.A.430 Landing — dry runways

LANDING MASS

CAT.POL.A.430 establishes two considerations in determining the maximum permissible landing mass at the destination and alternate aerodromes.

-
- (a) Firstly, the aeroplane mass will be such that on arrival the aeroplane can be landed within 70 % of the LDA on the most favourable (normally the longest) runway in still air. Regardless of the wind conditions, the maximum landing mass for an aerodrome/aeroplane configuration at a particular aerodrome cannot be exceeded.
 - (b) Secondly, consideration should be given to anticipated conditions and circumstances. The expected wind, or ATC and noise abatement procedures may indicate the use of a different runway. These factors may result in a lower landing mass than that permitted under (a), in which case dispatch should be based on this lesser mass.
 - (c) The expected wind referred to in (b) is the wind expected to exist at the time of arrival.

CAT.POLA.435 Landing — wet and contaminated runways

- (a) When the appropriate weather reports and/or forecasts indicate that the runway at the estimated time of arrival may be wet, the LDA shall be equal to or exceed the required landing distance, determined in accordance with CAT.POLA.430, multiplied by a factor of 1,15.
- (b) When the appropriate weather reports and/or forecasts indicate that the runway at the estimated time of arrival may be contaminated, the landing distance shall not exceed the LDA. The operator shall specify in the operations manual the landing distance data to be applied.

SECTION 2
Helicopters**CHAPTER 1**
General requirements**CAT.POL.H.100 Applicability**

- (a) Helicopters shall be operated in accordance with the applicable performance class requirements.
- (b) Helicopters shall be operated in performance class 1:
 - (1) when operated to/from aerodromes or operating sites located in a congested hostile environment, except when operated to/from a public interest site (PIS) in accordance with CAT.POL.H.225; or
 - (2) when having an MOPSC of more than 19, except when operated to/from a helideck in performance class 2 under an approval in accordance with CAT.POL.H.305.
- (c) Unless otherwise prescribed by (b), helicopters that have an MOPSC of 19 or less but more than nine shall be operated in performance class 1 or 2.
- (d) Unless otherwise prescribed by (b), helicopters that have an MOPSC of nine or less shall be operated in performance class 1, 2 or 3.

CAT.POL.H.105 General

- (a) The mass of the helicopter:
 - (1) at the start of the take-off; or
 - (2) in the event of in-flight replanning, at the point from which the revised operational flight plan applies,

shall not be greater than the mass at which the applicable requirements of this Section can be complied with for the flight to be undertaken, taking into account expected reductions in mass as the flight proceeds and such fuel jettisoning as is provided for in the relevant requirement.
- (b) The approved performance data contained in the AFM shall be used to determine compliance with the requirements of this Section, supplemented as necessary with other data as prescribed in the relevant requirement. The operator shall specify such other data in the operations manual. When applying the factors prescribed in this Section, account may be taken of any operational factors already incorporated in the AFM performance data to avoid double application of factors.
- (c) When showing compliance with the requirements of this Section, account shall be taken of the following parameters:
 - (1) mass of the helicopter;
 - (2) the helicopter configuration;
 - (3) the environmental conditions, in particular:
 - (i) pressure altitude and temperature;
 - (ii) wind:

- (A) except as provided in (C), for take-off, take-off flight path and landing requirements, accountability for wind shall be no more than 50 % of any reported steady headwind component of 5 kt or more;
 - (B) where take-off and landing with a tailwind component is permitted in the AFM, and in all cases for the take-off flight path, not less than 150 % of any reported tailwind component shall be taken into account; and
 - (C) where precise wind measuring equipment enables accurate measurement of wind velocity over the point of take-off and landing, wind components in excess of 50 % may be established by the operator, provided that the operator demonstrates to the competent authority that the proximity to the FATO and accuracy enhancements of the wind measuring equipment provide an equivalent level of safety;
- (4) the operating techniques; and
 - (5) the operation of any systems that have an adverse effect on performance.

GM1 CAT.POL.H.105(c)(3)(ii)(A) General

REPORTED HEADWIND COMPONENT

The reported headwind component should be interpreted as being that reported at the time of flight planning and may be used, provided there is no significant change of unfactored wind prior to take-off.

CAT.POL.H.110 Obstacle accountability

- (a) For the purpose of obstacle clearance requirements, an obstacle located beyond the FATO, in the take-off flight path, or the missed approach flight path shall be considered if its lateral distance from the nearest point on the surface below the intended flight path is not further than the following:
- (1) For operations under VFR:
 - (i) half of the minimum width defined in the AFM — or, when no width is defined, $0,75 \times D'$, where D is the largest dimension of the helicopter when the rotors are turning;
 - (ii) plus, the greater of $0,25 \times D'$ or 3 m ;
 - (iii) plus:
 - (A) $0,10 \times \text{distance DR}$ for operations under VFR by day; or
 - (B) $0,15 \times \text{distance DR}$ for operations under VFR at night.
 - (2) For operations under IFR:
 - (i) $1,5 D'$ or 30 m , whichever is greater, plus:
 - (A) $0,10 \times \text{distance DR}$, for operations under IFR with accurate course guidance;
 - (B) $0,15 \times \text{distance DR}$, for operations under IFR with standard course guidance; or
 - (C) $0,30 \times \text{distance DR}$ for operations under IFR without course guidance.
 - (ii) When considering the missed approach flight path, the divergence of the obstacle accountability area only applies after the end of the take-off distance available.
 - (3) For operations with initial take-off conducted visually and converted to IFR/IMC at a transition point, the criteria required in (1) apply up to the transition point, and the criteria required in (2) apply after the transition point. The transition point cannot be located before the end of the take-off distance required for helicopters (TODRH) operating in performance class 1 or before the defined point after take-off (DPATO) for helicopters operating in performance class 2.
- (b) For take-off using a back-up or a lateral transition procedure, for the purpose of obstacle clearance requirements, an obstacle located in the back-up or lateral transition area shall be considered if its lateral distance from the nearest point on the surface below the intended flight path is not further than:
- (1) half of the minimum width defined in the AFM or, when no width is defined, $0,75 \times D'$;
 - (2) plus the greater of $0,25 \times D'$ or 3 m ;
 - (3) plus:
 - (i) for operations under VFR by day $0,10 \times \text{the distance travelled from the back of the FATO}$, or
 - (ii) for operations under VFR at night $0,15 \times \text{the distance travelled from the back of the FATO}$.
- (c) Obstacles may be disregarded if they are situated beyond:
- (1) $7 \times \text{rotor radius (R)}$ for day operations, if it is assured that navigational accuracy can be achieved by reference to suitable visual cues during the climb;
 - (2) $10 \times R$ for night operations, if it is assured that navigational accuracy can be achieved by reference to suitable visual cues during the climb;

-
- (3) 300 m if navigational accuracy can be achieved by appropriate navigation aids; or
 - (4) 900 m in all other cases.

GM1 CAT.POL.H.110(a)(2)(i) Obstacle accountability**COURSE GUIDANCE**

Standard course guidance includes automatic direction finder (ADF) and VHF omnidirectional radio range (VOR) guidance.

Accurate course guidance includes ILS, MLS or other course guidance providing an equivalent navigational accuracy.

CHAPTER 2

Performance class 1

CAT.POL.H.200 General

Helicopters operated in performance class 1 shall be certified in category A or equivalent as determined by the Agency.

GM1 CAT.POL.H.200 & CAT.POL.H.300 & CAT.POL.H.400 General

CATEGORY A AND CATEGORY B

- (a) Helicopters that have been certified according to any of the following standards are considered to satisfy the Category A criteria. Provided that they have the necessary performance information scheduled in the AFM, such helicopters are, therefore, eligible for performance class 1 or 2 operations:
- (1) certification as Category A under CS-27 or CS-29;
 - (2) certification as Category A under JAR-27 or JAR-29;
 - (3) certification as Category A under FAR Part 29;
 - (4) certification as group A under BCAR Section G; and
 - (5) certification as group A under BCAR-29.
- (b) In addition to the above, certain helicopters have been certified under FAR Part 27 and with compliance with FAR Part 29 engine isolation requirements as specified in FAA Advisory Circular AC 27-1. Provided that compliance is established with the following additional requirements of CS-29:
- (1) CS 29.1027(a) Independence of engine and rotor drive system lubrication;
 - (2) CS 29.1187(e);
 - (3) CS 29.1195(a) & (b) Provision of a one-shot fire extinguishing system for each engine;
 - (i) The requirement to fit a fire extinguishing system may be waived if the helicopter manufacturer can demonstrate equivalent safety, based on service experience for the entire fleet showing that the actual incidence of fires in the engine fire zones has been negligible.
 - (4) CS 29.1197;
 - (5) CS 29.1199;
 - (6) CS 29.1201; and
 - (7) CS 29.1323(c)(1) Ability of the airspeed indicator to consistently identify the take-off decision point,
- these helicopters are considered to satisfy the requirement to be certified as equivalent to Category A.
- (c) The performance operating rules of JAR-OPS 3, which were transposed into this Part, were drafted in conjunction with the performance requirements of JAR-29 Issue 1 and FAR Part 29 at amendment 29-39. For helicopters certificated under FAR Part 29 at an earlier amendment, or under BCAR section G or BCAR-29, performance data will have been scheduled in the AFM

according to these earlier requirements. This earlier scheduled data may not be fully compatible with this Part.

- (d) Before any AOC is issued under which performance class 1 or 2 operations are conducted, it should be established that scheduled performance data are available that are compatible with the requirements of performance class 1 and 2 respectively.
- (e) Any properly certified helicopter is considered to satisfy the Category B criteria. If appropriately equipped (in accordance with CAT.IDE.H), such helicopters are, therefore, eligible for performance class 3 operations.

CAT.POL.H.205 Take-off

- (a) The take-off mass shall not exceed the maximum take-off mass specified in the AFM for the procedure to be used.
- (b) The take-off mass shall be such that:
 - (1) it is possible to reject the take-off and land on the FATO in case of the critical engine failure being recognised at or before the take-off decision point (TDP);
 - (2) the rejected take-off distance required (RTODRH) does not exceed the rejected take-off distance available (RTODAH); and
 - (3) the TODRH does not exceed the take-off distance available (TODAH).
 - (4) Notwithstanding (b)(3), the TODRH may exceed the TODAH if the helicopter, with the critical engine failure recognised at TDP can, when continuing the take-off, clear all obstacles to the end of the TODRH by a vertical margin of not less than 10,7 m (35 ft).
- (c) When showing compliance with (a) and (b), account shall be taken of the appropriate parameters of CAT.POL.H.105(c) at the aerodrome or operating site of departure.
- (d) That part of the take-off up to and including TDP shall be conducted in sight of the surface such that a rejected take-off can be carried out.
- (e) For take-off using a backup or lateral transition procedure, with the critical engine failure recognition at or before the TDP, all obstacles in the back-up or lateral transition area shall be cleared by an adequate margin.

AMC1 CAT.POL.H.205(b)(4) Take-off

THE APPLICATION OF TODRH

The selected height should be determined with the use of AFM data, and be at least 10.7 m (35 ft) above:

- (a) the take-off surface; or
- (b) as an alternative, a level height defined by the highest obstacle in the take-off distance required.

GM1 CAT.POL.H.205(b)(4) Take-off

THE APPLICATION OF TODRH

(a) Introduction

Original definitions for helicopter performance were derived from aeroplanes; hence, the definition of take-off distance owes much to operations from runways. Helicopters on the other hand can operate from runways, confined and restricted areas and rooftop FATOs — all bounded by obstacles. As an analogy, this is equivalent to a take-off from a runway with obstacles on and surrounding it.

It can, therefore, be said that unless the original definitions from aeroplanes are tailored for helicopters, the flexibility of the helicopter might be constrained by the language of operational performance.

This GM concentrates on the critical term ‘take-off distance required (TODRH)’ and describes the methods to achieve compliance with it and, in particular, the alternative procedure described in ICAO Annex 6 Attachment A 4.1.1.3:

- (1) the take-off distance required does not exceed the take-off distance available; or

- (2) as an alternative, the take-off distance required may be disregarded provided that the helicopter with the critical engine failure recognised at TDP can, when continuing the take-off, clear all obstacles between the end of the take-off distance available and the point at which it becomes established in a climb at V_{TOSS} by a vertical margin of 10.7 m (35 ft) or more. An obstacle is considered to be in the path of the helicopter if its distance from the nearest point on the surface below the intended line of flight does not exceed 30 m or 1.5 times the maximum dimension of the helicopter, whichever is greater.

(b) Definition of TODRH

The definition of TODRH from Annex I is as follows:

‘Take-off distance required (TODRH)’ in the case of helicopters means the horizontal distance required from the start of the take-off to the point at which take-off safety speed (V_{TOSS}), a selected height and a positive climb gradient are achieved, following failure of the critical engine being recognised at the TDP, the remaining engines operating within approved operating limits.

AMC1 CAT.POL.H.205(b)(4) states how the specified height should be determined.

The original definition of TODRH was based only on the first part of this definition.

(c) The clear area procedure (runway)

In the past, helicopters certified in Category A would have had, at the least, a ‘clear area’ procedure. This procedure is analogous to an aeroplane Category A procedure and assumes a runway (either metalled or grass) with a smooth surface suitable for an aeroplane take-off (see Figure 1).

The helicopter is assumed to accelerate down the FATO (runway) outside of the height velocity (HV) diagram. If the helicopter has an engine failure before TDP, it must be able to land back on the FATO (runway) without damage to helicopter or passengers; if there is a failure at or after TDP the aircraft is permitted to lose height — providing it does not descend below a specified height above the surface (usually 15 ft if the TDP is above 15 ft). Errors by the pilot are taken into consideration, but the smooth surface of the FATO limits serious damage if the error margin is eroded (e.g. by a change of wind conditions).

Figure 1

Clear Area take – off

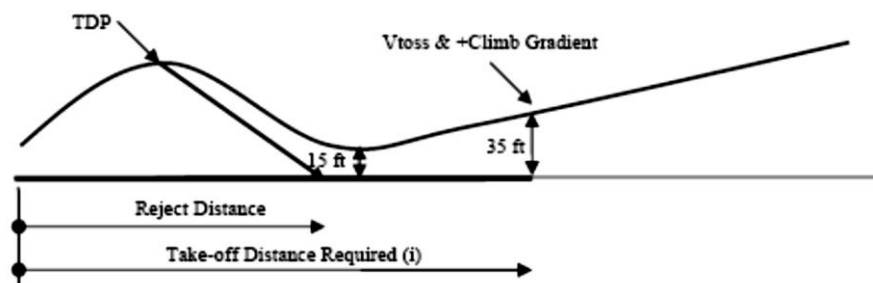

The operator only has to establish that the distances required are within the distance available (take-off distance and reject distance). The original definition of TODRH meets this case exactly.

From the end of the TODRH obstacle clearance is given by the climb gradient of the first or second climb segment meeting the requirement of CAT.POL.H.210 (or for performance class 2 (PC2): CAT.POL.H.315). The clearance margin from obstacles in the take-off flight path takes account of the distance travelled from the end of the take-off distance required and operational conditions (IMC or VMC).

(d) Category A procedures other-than-clear area

Procedures other-than-the-clear area are treated somewhat differently. However, the short field procedure is somewhat of a hybrid as either (a) or (b) of AMC1 CAT.POL.H.205(b)(4) can be utilised (the term ‘helipad’ is used in the following section to illustrate the principle only, it is not intended as a replacement for ‘aerodrome’ or ‘FATO’).

(1) Limited area, restricted area and helipad procedures (other than elevated)

The exact names of the procedure used for other-than-clear area are as many as there are manufacturers. However, principles for obstacle clearance are generic and the name is unimportant.

These procedures (see Figure 2 and Figure 3) are usually associated with an obstacle in the continued take-off area — usually shown as a line of trees or some other natural obstacle. As clearance above such obstacles is not readily associated with an accelerative procedure, as described in (c), a procedure using a vertical climb (or a steep climb in the forward, sideways or rearward direction) is utilised.

Figure 2

Short Field take-off

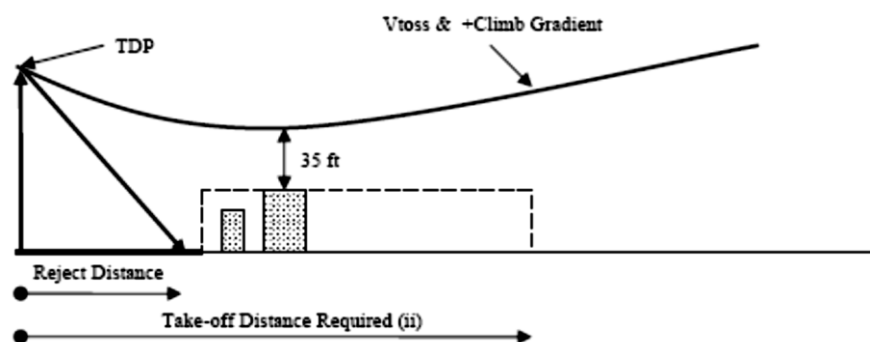

With the added complication of a TDP principally defined by height together with obstacles in the continued take off area, a drop down to within 15 ft of the take-off surface is not deemed appropriate and the required obstacle clearance is set to 35 ft (usually called ‘min-dip’). The distance to the obstacle does not need to be calculated (provided it is outside the rejected distance required), as clearance above all obstacles is provided by ensuring that helicopter does not descend below the min-dip associated with a level defined by the highest obstacle in the continued take-off area.

Figure 3

Helipad take-off

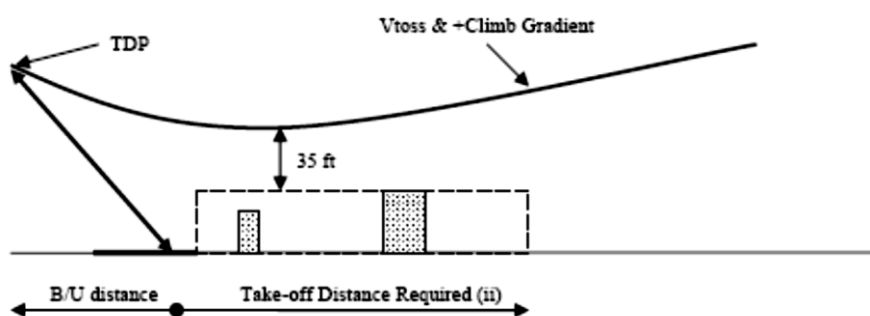

These procedures depend upon (b) of AMC1 CAT.POL.H.205(b)(4).

As shown in Figure 3, the point at which V_{TOSS} and a positive rate of climb are met defines the TODRH. Obstacle clearance from that point is assured by meeting the requirement of CAT.POL.H.210 (or for PC2, CAT.POL.H.315). Also shown in Figure 3 is the distance behind the helipad which is the backup distance (B/U distance).

(2) Elevated helipad procedures

The elevated helipad procedure (see Figure 4) is a special case of the ground level helipad procedure discussed above.

Figure 4

Elevate Helipad take-off

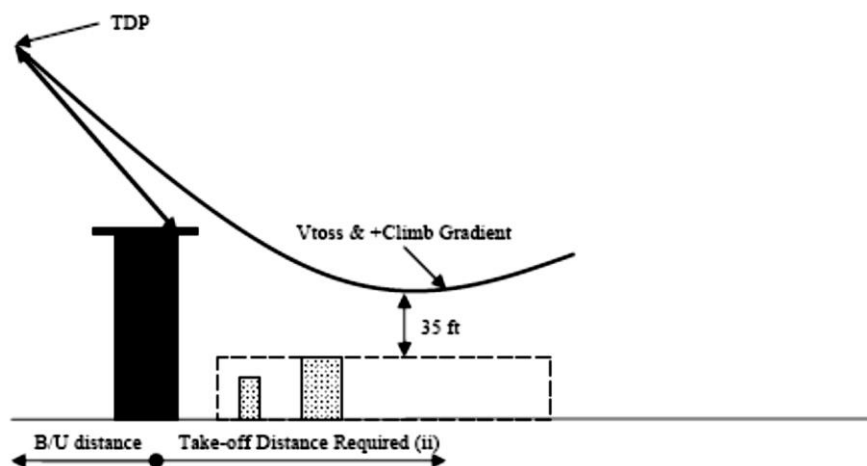

The main difference is that drop down below the level of the take-off surface is permitted. In the drop down phase, the Category A procedure ensures deck-edge clearance but, once clear of the deck-edge, the 35 ft clearance from obstacles relies upon the calculation of drop down. Subparagraph (b) of AMC1 CAT.POL.H.205(b)(4) is applied.

Although 35 ft is used throughout the requirements, it may be inadequate at particular elevated FATOs that are subject to adverse airflow effects, turbulence, etc.

AMC1 CAT.POL.H.205(e) Take-off

OBSTACLE CLEARANCE IN THE BACKUP AREA

- (a) The requirement in CAT.POL.H.205(e) has been established in order to take into account the following factors:
- (1) in the backup: the pilot has few visual cues and has to rely upon the altimeter and sight picture through the front window (if flight path guidance is not provided) to achieve an accurate rearward flight path;
 - (2) in the rejected take-off: the pilot has to be able to manage the descent against a varying forward speed whilst still ensuring an adequate clearance from obstacles until the helicopter gets in close proximity for landing on the FATO; and
 - (3) in the continued take-off; the pilot has to be able to accelerate to V_{TOSS} (take-off safety speed for Category A helicopters) whilst ensuring an adequate clearance from obstacles.
- (b) The requirements of CAT.POL.H.205(e) may be achieved by establishing that:

- (1) in the backup area no obstacles are located within the safety zone below the rearward flight path when described in the AFM (see Figure 1, in the absence of such data in the AFM, the operator should contact the manufacturer in order to define a safety zone); or
- (2) during the backup, the rejected take-off and the continued take-off manoeuvres, obstacle clearance is demonstrated to the competent authority.

Figure 1

Rearward flight path

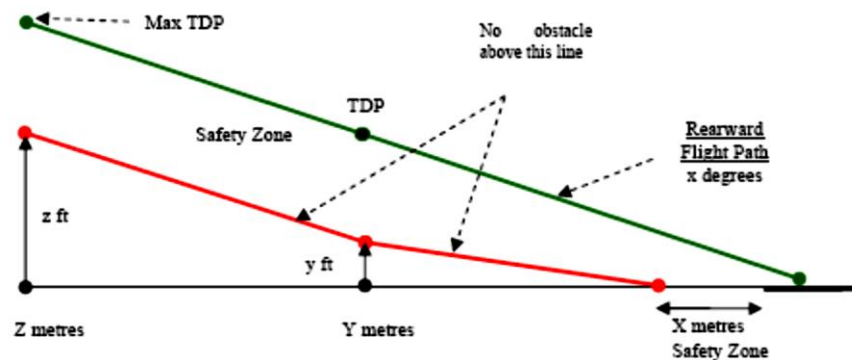

- (c) An obstacle, in the backup area, is considered if its lateral distance from the nearest point on the surface below the intended flight path is not further than:
 - (1) half of the minimum FATO (or the equivalent term used in the AFM) width defined in the AFM (or, when no width is defined $0.75 D$, where D is the largest dimension of the helicopter when the rotors are turning); plus
 - (2) 0.25 times D (or 3 m, whichever is greater); plus
 - (3) 0.10 for VFR day, or 0.15 for VFR night, of the distance travelled from the back of the FATO (see Figure 2).

Figure 2

Obstacle accountability

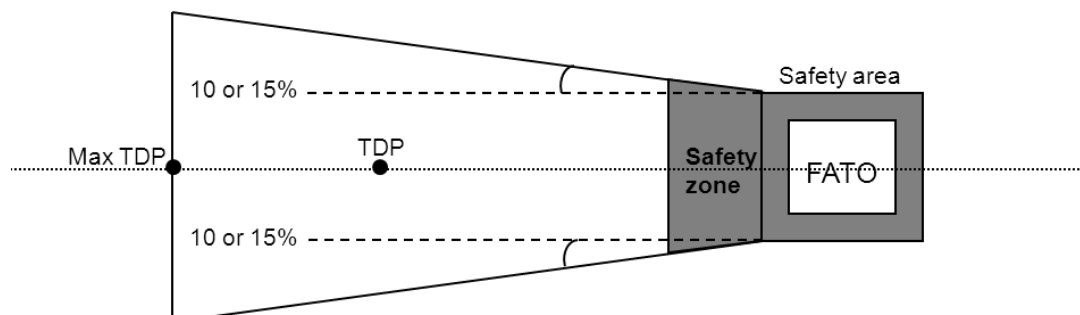

AMC1 CAT.POL.H.205 & CAT.POL.H.220 Take-off and landing

APPLICATION FOR ALTERNATIVE TAKE-OFF AND LANDING PROCEDURES

- (a) A reduction in the size of the take-off surface may be applied when the operator has demonstrated to the competent authority that compliance with the requirements of CAT.POL.H.205, 210 and 220 can be assured with:

- (1) a procedure based upon an appropriate Category A take-off and landing profile scheduled in the AFM;
 - (2) a take-off or landing mass not exceeding the mass scheduled in the AFM for a hover-out-of-ground-effect one-engine-inoperative (HOGE OEI) ensuring that:
 - (i) following an engine failure at or before TDP, there are adequate external references to ensure that the helicopter can be landed in a controlled manner; and
 - (ii) following an engine failure at or after the landing decision point (LDP), there are adequate external references to ensure that the helicopter can be landed in a controlled manner.
- (b) An upwards shift of the TDP and LDP may be applied when the operator has demonstrated to the competent authority that compliance with the requirements of CAT.POL.H.205, 210 and 220 can be assured with:
- (1) a procedure based upon an appropriate Category A take-off and landing profile scheduled in the AFM;
 - (2) a take-off or landing mass not exceeding the mass scheduled in the AFM for a HOGE OEI ensuring that:
 - (i) following an engine failure at or after TDP compliance with the obstacle clearance requirements of CAT.POL.H.205 (b)(4) and CAT.POL.H.210 can be met; and
 - (ii) following an engine failure at or before the LDP the balked landing obstacle clearance requirements of CAT.POL.H.220 (b) and CAT.POL.H.210 can be met.
- (c) The Category A ground level surface area requirement may be applied at a specific elevated FATO when the operator can demonstrate to the competent authority that the usable cue environment at that aerodrome/operating site would permit such a reduction in size.

GM1 CAT.POL.H.205&CAT.POL.H.220 Take-off and landing

APPLICATION FOR ALTERNATIVE TAKE-OFF AND LANDING PROCEDURES

The manufacturer's Category A procedure defines profiles and scheduled data for take-off, climb, performance at minimum operating speed and landing, under specific environmental conditions and masses.

Associated with these profiles and conditions are minimum operating surfaces, take-off distances, climb performance and landing distances; these are provided (usually in graphic form) with the take-off and landing masses and the take-off decision point (TDP) and landing decision point (LDP).

The landing surface and the height of the TDP are directly related to the ability of the helicopter — following an engine failure before or at TDP — to reject onto the surface under forced landing conditions. The main considerations in establishing the minimum size of the landing surface are the scatter during flight testing of the reject manoeuvre, with the remaining engine operating within approved limits, and the required usable cue environment.

Hence, an elevated site with few visual cues — apart from the surface itself — would require a greater surface area in order that the helicopter can be accurately positioned during the reject manoeuvre within the specified area. This usually results in the stipulation of a larger surface for an elevated site than for a ground level site (where lateral cues may be present).

This could have the unfortunate side effect that a FATO that is built 3 m above the surface (and, therefore, elevated by definition) might be out of operational scope for some helicopters — even though there might be a rich visual cue environment where rejects are not problematical. The presence of

elevated sites where ground level surface requirements might be more appropriate could be brought to the attention of the competent authority.

It can be seen that the size of the surface is directly related to the requirement of the helicopter to complete a rejected take-off following an engine failure. If the helicopter has sufficient power such that a failure before or at TDP will not lead to a requirement for rejected take-off, the need for large surfaces is removed; sufficient power for the purpose of this GM is considered to be the power required for hover-out-of-ground-effect one-engine-inoperative (HOGE OEI).

Following an engine failure at or after the TDP, the continued take-off path provides OEI clearance from the take-off surface and the distance to reach a point from where climb performance in the first, and subsequent segments, is assured.

If HOGE OEI performance exists at the height of the TDP, it follows that the continued take-off profile, which has been defined for a helicopter with a mass such that a rejected take-off would be required following an engine failure at or before TDP, would provide the same, or better, obstacle clearance and the same, or less, distance to reach a point where climb performance in the first, and subsequent segments, is assured.

If the TDP is shifted upwards, provided that the HOGE OEI performance is established at the revised TDP, it will not affect the shape of the continued take-off profile but should shift the min-dip upwards by the same amount that the revised TDP has been increased — with respect to the basic TDP.

Such assertions are concerned only with the vertical or the backup procedures and can be regarded as achievable under the following circumstances:

- (a) when the procedure is flown, it is based upon a profile contained in the AFM — with the exception of the necessity to perform a rejected take-off;
- (b) the TDP, if shifted upwards (or upwards and backward in the backup procedure) will be the height at which the HOGE OEI performance is established; and
- (c) if obstacles are permitted in the backup area, they should continue to be permitted with a revised TDP.

CAT.POL.H.210 Take-off flight path

- (a) From the end of the TODRH with the critical engine failure recognised at the TDP:
- (1) The take-off mass shall be such that the take-off flight path provides a vertical clearance, above all obstacles located in the climb path, of not less than 10,7 m (35 ft) for operations under VFR and 10,7 m (35 ft) + 0,01 × distance DR for operations under IFR. Only obstacles as specified in CAT.POL.H.110 have to be considered.
 - (2) Where a change of direction of more than 15° is made, adequate allowance shall be made for the effect of bank angle on the ability to comply with the obstacle clearance requirements. This turn is not to be initiated before reaching a height of 61 m (200 ft) above the take-off surface unless it is part of an approved procedure in the AFM.
- (b) When showing compliance with (a), account shall be taken of the appropriate parameters of CAT.POL.H.105(c) at the aerodrome or operating site of departure.

CAT.POL.H.215 En-route — critical engine inoperative

- (a) The mass of the helicopter and flight path at all points along the route, with the critical engine inoperative and the meteorological conditions expected for the flight, shall permit compliance with (1), (2) or (3):
- (1) When it is intended that the flight will be conducted at any time out of sight of the surface, the mass of the helicopter permits a rate of climb of at least 50 ft/minute with the critical engine inoperative at an altitude of at least 300 m (1 000 ft), or 600 m (2 000 ft) in areas of mountainous terrain, above all terrain and obstacles along the route within 9,3 km (5 NM) on either side of the intended track.
 - (2) When it is intended that the flight will be conducted without the surface in sight, the flight path permits the helicopter to continue flight from the cruising altitude to a height of 300 m (1 000 ft) above a landing site where a landing can be made in accordance with CAT.POL.H.220. The flight path clears vertically, by at least 300 m (1 000 ft) or 600 m (2 000 ft) in areas of mountainous terrain, all terrain and obstacles along the route within 9,3 km (5 NM) on either side of the intended track. Drift-down techniques may be used.
 - (3) When it is intended that the flight will be conducted in VMC with the surface in sight, the flight path permits the helicopter to continue flight from the cruising altitude to a height of 300 m (1 000 ft) above a landing site where a landing can be made in accordance with CAT.POL.H.220, without flying at any time below the appropriate minimum flight altitude. Obstacles within 900 m on either side of the route need to be considered.
- (b) When showing compliance with (a)(2) or (a)(3):
- (1) the critical engine is assumed to fail at the most critical point along the route;
 - (2) account is taken of the effects of winds on the flight path;
 - (3) fuel jettisoning is planned to take place only to an extent consistent with reaching the aerodrome or operating site with the required fuel reserves and using a safe procedure; and
 - (4) fuel jettisoning is not planned below 1 000 ft above terrain.
- (c) The width margins of (a)(1) and (a)(2) shall be increased to 18,5 km (10 NM) if the navigational accuracy cannot be met for 95 % of the total flight time.

GM1 CAT.POL.H.215(b)(3) En-route — critical engine inoperative**FUEL JETTISON**

The presence of obstacles along the en-route flight path may preclude compliance with CAT.POL.H.215 (a)(1) at the planned mass at the critical point along the route. In this case fuel jettison at the most critical point may be planned, provided that the procedures of (c) in AMC3 CAT.OP.MPA.150(b) are complied with.

CAT.POL.H.220 Landing

- (a) The landing mass of the helicopter at the estimated time of landing shall not exceed the maximum mass specified in the AFM for the procedure to be used.
- (b) In the event of the critical engine failure being recognised at any point at or before the landing decision point (LDP), it is possible either to land and stop within the FATO, or to perform a balked landing and clear all obstacles in the flight path by a vertical margin of 10,7 m (35 ft). Only obstacles as specified in CAT.POL.H.110 have to be considered.
- (c) In the event of the critical engine failure being recognised at any point at or after the LDP, it is possible to:
 - (1) clear all obstacles in the approach path; and
 - (2) land and stop within the FATO.
- (d) When showing compliance with (a) to (c), account shall be taken of the appropriate parameters of CAT.POL.H.105(c) for the estimated time of landing at the destination aerodrome or operating site, or any alternate if required.
- (e) That part of the landing from the LDP to touchdown shall be conducted in sight of the surface.

GM1 CAT.POL.H.205&CAT.POL.H.220 Take-off and landing

See [here](#).

CAT.POL.H.225 Helicopter operations to/from a public interest site

- (a) Operations to/from a public interest site (PIS) may be conducted in performance class 2, without complying with CAT.POL.H.310(b) or CAT.POL.H.325(b), provided that all of the following are complied with:
- (1) the PIS was in use before 1 July 2002;
 - (2) the size of the PIS or obstacle environment does not permit compliance with the requirements for operation in performance class 1;
 - (3) the operation is conducted with a helicopter with an MOPSC of six or less;
 - (4) the operator complies with CAT.POL.H.305(b)(2) and (b)(3);
 - (5) the helicopter mass does not exceed the maximum mass specified in the AFM for a climb gradient of 8 % in still air at the appropriate take-off safety speed (V_{TOSS}) with the critical engine inoperative and the remaining engines operating at an appropriate power rating; and
 - (6) the operator has obtained prior approval for the operation from the competent authority. Before such operations take place in another Member State, the operator shall obtain an endorsement from the competent authority of that State.
- (b) Site-specific procedures shall be established in the operations manual to minimise the period during which there would be danger to helicopter occupants and persons on the surface in the event of an engine failure during take-off and landing.
- (c) The operations manual shall contain for each PIS: a diagram or annotated photograph, showing the main aspects, the dimensions, the non-conformance with the requirements performance class 1, the main hazards and the contingency plan should an incident occur.

AMC1 CAT.POL.H.225(a)(5) Helicopter operations to/from a public interest site

HELICOPTER MASS LIMITATION

- (a) The helicopter mass limitation at take-off or landing specified in CAT.POL.H.225(a)(5) should be determined using the climb performance data from 35 ft to 200 ft at V_{TOSS} (first segment of the take-off flight path) contained in the Category A supplement of the AFM (or equivalent manufacturer data acceptable in accordance with GM1-CAT.POL.H.200 & CAT.POL.H.300 & CAT.POL.H.400).
- (b) The first segment climb data to be considered is established for a climb at the take-off safety speed V_{TOSS} , with the landing gear extended (when the landing gear is retractable), with the critical engine inoperative and the remaining engines operating at an appropriate power rating (the 2 min 30 sec or 2 min OEI power rating, depending on the helicopter type certification). The appropriate V_{TOSS} , is the value specified in the Category A performance section of the AFM for vertical take-off and landing procedures (VTOL, helipad or equivalent manufacturer terminology).
- (c) The ambient conditions at the site (pressure-altitude and temperature) should be taken into account.
- (d) The data are usually provided in charts in one of the following ways:
- (1) Height gain in ft over a horizontal distance of 100 ft in the first segment configuration (35 ft to 200 ft, V_{TOSS} , 2 min 30 sec/2 min OEI power rating). This chart should be entered with a height gain of 8 ft per 100 ft horizontally travelled, resulting in a mass value for every pressure-altitude/temperature combination considered.

- (2) Horizontal distance to climb from 35 ft to 200 ft in the first segment configuration (V_{TOSS} , 2 min 30 sec/2 min OEI power rating). This chart should be entered with a horizontally distance of 628 m (2 062 ft), resulting in a mass value for every pressure-altitude/temperature combination considered.
- (3) Rate of climb in the first segment configuration (35 ft to 200 ft, V_{TOSS} , 2 min 30 sec/2 min OEI power rating). This chart can be entered with a rate of climb equal to the climb speed (V_{TOSS}) value in knots (converted to true airspeed) multiplied by 8.1, resulting in a mass value for every pressure-altitude/temperature combination considered.

GM1 CAT.POL.H.225 Helicopter operations to/from a public interest site

UNDERLYING PRINCIPLES

(a) General

The original Joint Aviation Authorities (JAA) Appendix 1 to JAR-OPS 3.005(i) was introduced in January 2002 to address problems that had been encountered by Member States at hospital sites due to the applicable performance requirements of JAR-OPS 3 Subparts G and H. These problems were enumerated in ACJ to Appendix 1 to JAR-OPS 3.005(d) paragraph 8, part of which is reproduced below.

'8 Problems with hospital sites

During implementation of JAR-OPS 3, it was established that a number of States had encountered problems with the impact of performance rules where helicopters were operated for HEMS. Although States accept that progress should be made towards operations where risks associated with a critical power unit failure are eliminated, or limited by the exposure time concept, a number of landing sites exist which do not (or never can) allow operations to performance class 1 or 2 requirements.

These sites are generally found in a congested hostile environment:

- in the grounds of hospitals; or*
- on hospital buildings;*

The problem of hospital sites is mainly historical and, whilst the Authority could insist that such sites not be used - or used at such a low weight that critical power unit failure performance is assured, it would seriously curtail a number of existing operations.

Even though the rule for the use of such sites in hospital grounds for HEMS operations (Appendix 1 to JAR-OPS 3.005(d) sub-paragraph (c)(2)(i)(A)) attracts alleviation until 2005, it is only partial and will still impact upon present operations.

Because such operations are performed in the public interest, it was felt that the Authority should be able to exercise its discretion so as to allow continued use of such sites provided that it is satisfied that an adequate level of safety can be maintained - notwithstanding that the site does not allow operations to performance class 1 or 2 standards. However, it is in the interest of continuing improvements in safety that the alleviation of such operations be constrained to existing sites, and for a limited period.'

As stated in this ACJ and embodied in the text of the appendix, the solution was short-term (until 31 December 2004). During the commenting period of JAA NPA 18, representations were made to the JAA that the alleviation should be extended to 2009. The review committee, in not accepting this request, had in mind that this was a short-term solution to address an immediate problem, and a permanent solution should be sought.

(b) After 1 January 2005

Although elimination of such sites would remove the problem, it is recognised that phasing out, or rebuilding existing hospital sites, is a long-term goal which may not be cost-effective, or even possible, in some Member States.

It should be noted, however, that CAT.POL.H.225 (a) limits the problem by confining approvals to hospital sites established before 1 July 2002 (established in this context means either: built before that date, or brought into service before that date — this precise wording was used to avoid problems associated with a ground level aerodrome/operating site where no building would be required). Thus the problem of these sites is contained and reducing in severity. This date was set approximately 6 months after the intended implementation of the original JAR-OPS 3 appendix.

EASA adopted the JAA philosophy that, from 1st January 2005, approval would be confined to those sites where a CAT A procedure alone cannot solve the problem. The determination of whether the helicopter can or cannot be operated in accordance with performance class 1 should be established with the helicopter at a realistic payload and fuel to complete the mission. However, in order to reduce the risk at those sites, the application of the requirements contained in CAT.POL.H.225(a) should be applied.

Additionally and in order to promote understanding of the problem, the text contained in CAT.POL.H.225(c) refers to the performance class and not to ICAO Annex 14. Thus, Part C of the operations manual should reflect the non-conformance with performance class 1, as well as the site-specific procedures (approach and departure paths) to minimise the danger to third parties in the event of an incident.

The following paragraphs explain the problem and solutions.

(c) The problem associated with such sites

There is a number of problems: some of which can be solved with the use of appropriate helicopters and procedures; and others which, because of the size of the site or the obstacle environment, cannot. They consist of:

- (1) the size of the surface of the site (smaller than that required by the manufacturer's procedure);
- (2) an obstacle environment that prevents the use of the manufacturer's procedure (obstacles in the backup area); and
- (3) an obstacle environment that does not allow recovery following an engine failure in the critical phase of take-off (a line of buildings requiring a demanding gradient of climb) at a realistic payload and fuel to complete the mission.

- Problems associated with (c)(1): the inability to climb and conduct a rejected landing back to the site following an engine failure before the Decision Point (DP).
- Problems associated with (c)(2): as in (c)(1)).
- Problems associated with (c)(3): climb into an obstacle following an engine failure after DP.

Problems cannot be solved in the immediate future, but can, when mitigated with the use of the latest generation of helicopters (operated at a weight that can allow useful payloads and endurance), minimise exposure to risk.

(d) Long-term solution

Although not offering a complete solution, it was felt that a significant increase in safety could be achieved by applying an additional performance margin to such operations. This solution allowed the time restriction of 2004 to be removed.

The required performance level of 8 % climb gradient in the first segment reflects ICAO Annex 14 Volume II in 'Table 4-3 'Dimensions and slopes of obstacle limitations surfaces' for performance class 2.

The performance delta is achieved without the provision of further manufacturer's data by using existing graphs to provide the reduced take-off mass (RTOM).

If the solution in relation to the original problem is examined, the effects can be seen.

- (1) Solution with relation to (c)(1): although the problem still exists, the safest procedure is a dynamic take-off reducing the time taken to achieve V_{stayup} and thus allowing VFR recovery — if the failure occurs at or after V_y and 200 ft, an IFR recovery is possible.
- (2) Solution with relation to (c)(2): as in (c)(1) above.
- (3) Solution with relation to (c)(3): once again this does not give a complete solution, however, the performance delta minimises the time during which a climb over the obstacle cannot be achieved.

GM1 CAT.POL.H.225(a)(6) Helicopter operations to/from a public interest site

ENDORSEMENT FROM ANOTHER STATE

(a) Application to another State

To obtain an endorsement from another State, the operator should submit to that State:

- (1) the reasons that preclude compliance with the requirements for operations in performance class 1;
- (2) the site-specific procedures to minimise the period during which there would be danger to helicopter occupants and person on the surface in the event of an engine failure during take-off and landing; and
- (3) the extract from the operations manual to comply with CAT.POL.H.225(c).

(b) Endorsement from another State

Upon receiving the endorsement from another State, the operator should submit it together with the site-specific procedures and the reasons and justification that preclude the use of performance class 1 criteria to the competent authority issuing the AOC to obtain the approval or extend the approval to a new public interest site.

CHAPTER 3

Performance class 2

CAT.POL.H.300 General

Helicopters operated in performance class 2 shall be certified in category A or equivalent as determined by the Agency.

GM to Section 2, Chapter 3 performance class 2

OPERATIONS IN PERFORMANCE CLASS 2

(a) Introduction

This GM describes performance class 2 as established in Part-CAT. It has been produced for the purpose of:

- (1) explaining the underlying philosophy of operations in performance class 2;
- (2) showing simple means of compliance; and
- (3) explaining how to determine — with examples and diagrams:
 - (i) the take-off and landing masses;
 - (ii) the length of the safe forced landing area;
 - (iii) distances to establish obstacle clearance; and
 - (iv) entry point(s) into performance class 1.

It explains the derivation of performance class 2 from ICAO Annex 6 Part III and describes an alleviation that may be approved in accordance with CAT.POL.H.305 following a risk assessment.

It examines the basic requirements, discusses the limits of operation, and considers the benefits of the use of performance class 2.

It contains examples of performance class 2 in specific circumstances, and explains how these examples may be generalised to provide operators with methods of calculating landing distances and obstacle clearance.

(b) Definitions used in this GM

The definitions for the following terms, used in this GM, are contained in Annex I and its AMC:

- (1) distance DR;
- (2) defined point after take-off (DPATO);
- (3) defined point before landing (DPBL);
- (4) landing distance available (LDAH);
- (5) landing distance required (LDRH);
- (6) performance class 2;
- (7) safe forced landing (SFL); and
- (8) take-off distance available (TODAH).

The following terms, which are not defined Annex I, are used in this GM:

- V_T : a target speed at which to aim at the point of minimum ground clearance (min-dip) during acceleration from TDP to V_{TOSS} ;
- V_{50} : a target speed and height utilised to establish an AFM distance (in compliance with the requirement of CS/JAR 29.63) from which climb out is possible; and
- V_{stayup} : a colloquial term used to indicate a speed at which a descent would not result following an engine failure. This speed is several knots lower than V_{TOSS} at the equivalent take-off mass.

(c) What defines performance class 2

Performance class 2 can be considered as performance class 3 take-off or landing, and performance class 1 climb, cruise and descent. It comprises an all-engines-operating (AEO) obstacle clearance regime for the take-off or landing phases, and a OEI obstacle clearance regime for the climb, cruise, descent, approach and missed approach phases.

For the purpose of performance calculations in Part-CAT, the CS/JAR 29.67 Category A climb performance criteria is used:

- 150 ft/min at 1 000 ft (at V_y);

and depending on the choice of DPATO:

- 100 ft/min up to 200 ft (at V_{TOSS})

at the appropriate power settings.

(1) Comparison of obstacle clearance in all performance classes

Figure 1 shows the profiles of the three performance classes — superimposed on one diagram.

- Performance class 1 (PC1): from TDP, requires OEI obstacle clearance in all phases of flight; the construction of Category A procedures, provides for a flight path to the first climb segment, a level acceleration segment to V_y (which may be shown concurrent with the first segment), followed by the second climb segment from V_y at 200 ft (see Figure 1).

Figure 1

All Performance Classes (a comparison)

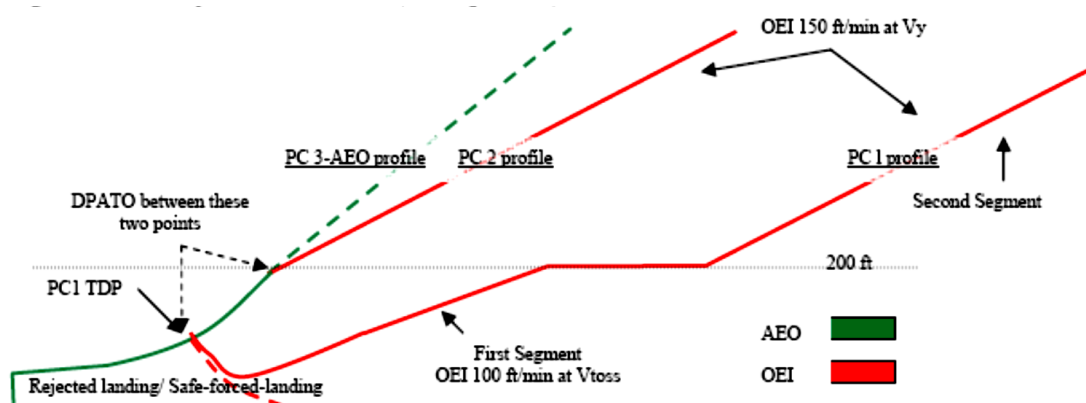

- Performance class 2 (PC2): requires AEO obstacle clearance to DPATO and OEI from then on. The take-off mass has the PC1 second segment climb performance at its basis therefore, at the point where V_y at 200 ft is reached, Performance Class 1 is achieved (see also Figure 3).
- Performance class 3 (PC3): requires AEO obstacle clearance in all phases.

Figure 2

Performance Class 1 distances

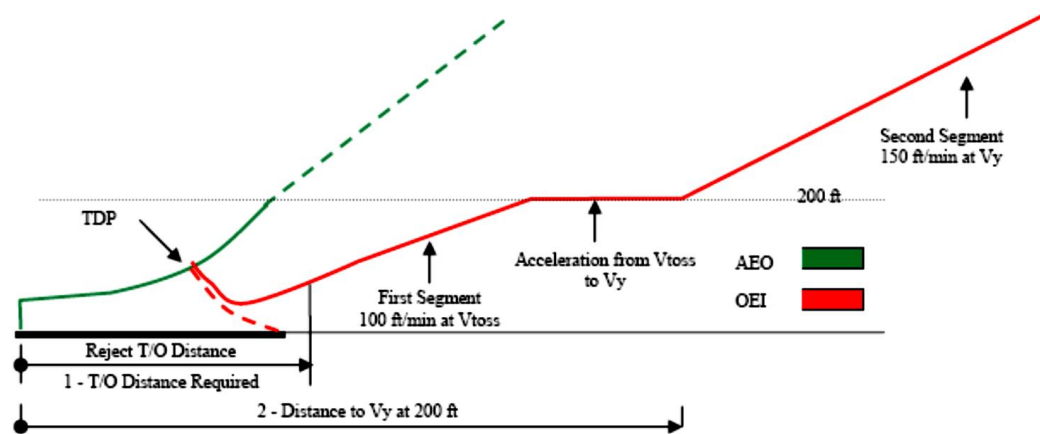

(2) Comparison of the discontinued take-off in all performance classes

- (i) PC1 — requires a prepared surface on which a rejected landing can be undertaken (no damage); and
- (ii) PC2 and 3 — require a safe forced landing surface (some damage can be tolerated, but there must be a reasonable expectancy of no injuries to persons in the aircraft or third parties on the surface).

(d) The derivation of performance class 2

PC2 is primarily based on the text of ICAO Annex 6 Part III Section II and its attachments which provide for the following:

- (1) obstacle clearance before DPATO: the helicopter shall be able, with all engines operating, to clear all obstacles by an adequate margin until it is in a position to comply with (2);
- (2) obstacle clearance after DPATO: the helicopter shall be able, in the event of the critical engine becoming inoperative at any time after reaching DPATO, to continue the take-off clearing all obstacles along the flight path by an adequate margin until it is able to comply with en-route clearances; and
- (3) engine failure before DPATO: before the DPATO, failure of the critical engine may cause the helicopter to force land; therefore, a safe forced landing should be possible (this is analogous to the requirement for a reject in performance class 1, but where some damage to the helicopter can be tolerated.)

(e) Benefits of performance class 2

Operations in performance class 2 permit advantage to be taken of an AEO procedure for a short period during take-off and landing — whilst retaining engine failure accountability in the climb, descent and cruise. The benefits include the ability to:

- (1) use (the reduced) distances scheduled for the AEO — thus permitting operations to take place at smaller aerodromes and allowing airspace requirements to be reduced;
- (2) operate when the safe forced landing distance available is located outside the boundary of the aerodrome;

- (3) operate when the take-off distance required is located outside the boundary of the aerodrome; and
- (4) use existing Category A profiles and distances when the surface conditions are not adequate for a reject, but are suitable for a safe forced landing (for example, when the ground is waterlogged).

Additionally, following a risk assessment when the use of exposure is approved by the competent authority the ability to:

- (i) operate when a safe forced landing is not assured in the take-off phase; and
 - (ii) penetrate the HV curve for short periods during take-off or landing.
- (f) Implementation of performance class 2 in Part-CAT

The following sections explain the principles of the implementation of performance class 2.

- (1) Does ICAO spell it all out?

ICAO Annex 6 does not give guidance on how DPATO should be calculated nor does it require that distances be established for the take-off. However, it does require that, up to DPATO AEO, and from DPATO OEI, obstacle clearance is established (see Figure 3 and Figure 4 which are simplified versions of the diagrams contained in Annex 6 Part III, Attachment A).

(ICAO Annex 8 – Airworthiness of Aircraft (IVA 2.2.3.1.4' and 'IVB 2.2.7 d) requires that an AEO distance be scheduled for all helicopters operating in performance classes 2 & 3. ICAO Annex 6 is dependent upon the scheduling of the AEO distances, required in Annex 8, to provide data for the location of DPATO.)

When showing obstacle clearance, the divergent obstacle clearance height required for IFR is — as in performance class 1 — achieved by the application of the additional obstacle clearance of 0.01 distance DR (the distance from the end of 'take-off-distance-available' — see the pictorial representation in Figure 4 and the definition in Annex I).

As can also be seen from Figure 4, flight must be conducted in VFR until DPATO has been achieved (and deduced that if an engine failure occurs before DPATO, entry into IFR is not permitted (as the OEI climb gradient will not have been established)).

Figure 3

Performance Class 2 Obstacle Clearance

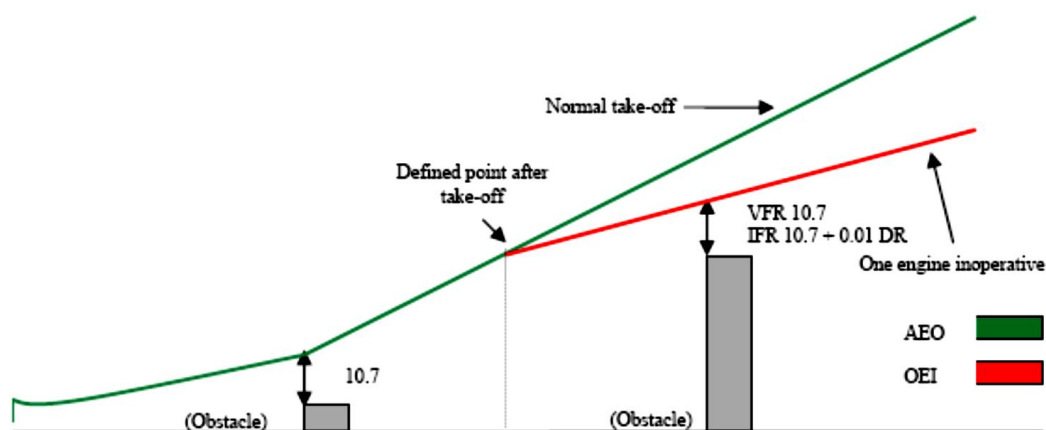
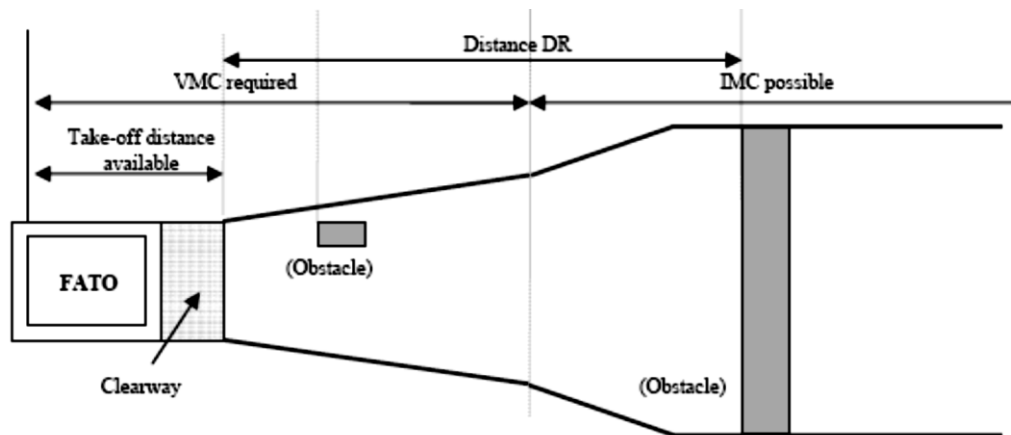

Figure 4

Performance Class 2 Obstacle Clearance (plan view)



(2) Function of DPATO

From the preceding paragraphs, it can be seen that DPATO is germane to PC2. It can also be seen that, in view of the many aspects of DPATO, it has, potentially, to satisfy a number of requirements that are not necessarily synchronised (nor need to be).

It is clear that it is only possible to establish a single point for DPATO, satisfying the requirement of (d)(2) & (d)(3), when:

- accepting the TDP of a Category A procedure; or
- extending the safe forced landing requirement beyond required distances (if data are available to permit the calculation of the distance for a safe forced landing from the DPATO).

It could be argued that the essential requirement for DPATO is contained in section (d)(2) — OEI obstacle clearance. From careful examination of the flight path reproduced in Figure 3 above, it may be reasonably deduced that DPATO is the point at which adequate climb performance is established (examination of Category A procedures would indicate that this could be (in terms of mass, speed and height above the take-off surface) the conditions at the start of the first or second segments — or any point between.)

(The diagrams in Attachment A of ICAO Annex 6 do not appear to take account of drop down — permitted under Category A procedures; similarly with helideck departures, the potential for acceleration in drop down below deck level (once the deck edge has been cleared) is also not shown. These omissions could be regarded as a simplification of the diagram, as drop down is discussed and accepted in the accompanying ICAO text.)

It may reasonably be argued that, during the take-off and before reaching an appropriate climb speed (V_{TOSS} or V_y), V_{stayup} will already have been achieved (where V_{stayup} is the ability to continue the flight and accelerate without descent — shown in some Category A procedures as V_T or target speed) and where, in the event of an engine failure, no landing would be required.

It is postulated that, to practically satisfy all the requirements of (d)(1), (2) and (3), DPATO does not need to be defined at one synchronised point; provisions can be met separately, i.e. defining the distance for a safe forced landing, and then establishing the OEI obstacle clearance flight path.

As the point at which the helicopter's ability to continue the flight safely, with the critical engine inoperative is the critical element, it is that for which DPATO is used in this text.

Figure 5

The three elements in a PC 2 take-off

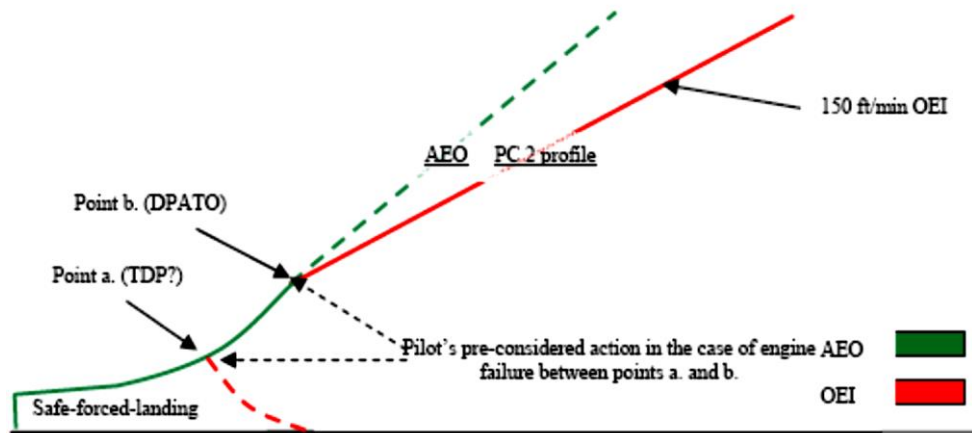

(i) The three elements from the pilot's perspective

When seen from the pilot's perspective (see Figure 5), there are three elements of the PC 2 take-off — each with associated related actions which need to be considered in the case of an engine failure:

- (A) action in the event of an engine failure — up to the point where a forced-landing will be required;
- (B) action in the event of an engine failure — from the point where OEI obstacle clearance is established (DPATO); and
- (C) pre-considered action in the event of an engine failure — in the period between (A) and (B)

The action of the pilot in (A) and (B) is deterministic, i.e. it remains the same for every occasion. For pre-consideration of the action at point (C), as is likely that the planned flight path will have to be abandoned (the point at which obstacle clearance using the OEI climb gradients not yet being reached), the pilot must (before take-off) have considered his/her options and the associated risks, and have in mind the course of action that will be pursued in the event of an engine failure during that short period. (As it is likely that any action will involve turning manoeuvres, the effect of turns on performance must be considered.)

(3) Take-off mass for performance class 2

As previously stated, performance class 2 is an AEO take-off that, from DPATO, has to meet the requirement for OEI obstacle clearance in the climb and en-route phases. Take-off mass is, therefore, the mass that gives at least the minimum climb performance of 150 ft/min at V_y , at 1 000 ft above the take-off point, and obstacle clearance.

As can be seen in Figure 6 below, the take-off mass may have to be modified when it does not provide the required OEI clearance from obstacles in the take-off-flight path (exactly as in performance class 1). This could occur when taking off from an aerodrome/operating site where the flight path has to clear an obstacle such a ridge line (or line of buildings) that can neither be:

- (i) flown around using VFR and see and avoid; nor
- (ii) cleared using the minimum climb gradient given by the take-off mass (150 ft/min at 1 000 ft).

In this case, the take-off mass has to be modified (using data contained in the AFM) to give an appropriate climb gradient.

Figure 6

Performance Class 2 (enhanced climb gradient)

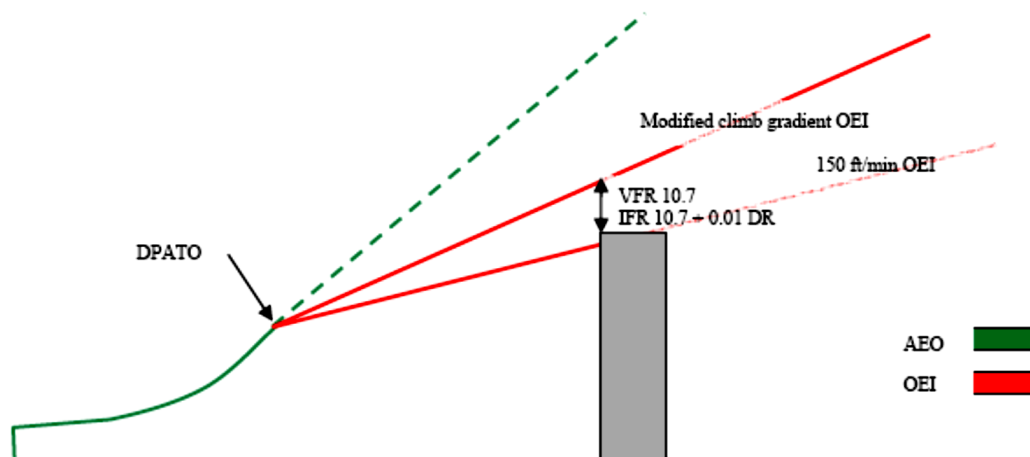

- (4) Do distances have to be calculated?

Distances do not have to be calculated if, by using pilot judgement or standard practice, it can be established that:

- (i) a safe forced landing is possible following an engine failure (notwithstanding that there might be obstacles in the take-off path); and
- (ii) obstacles can be cleared (or avoided) — AEO in the take-off phase and OEI in the climb.

If early entry (in the sense of cloud base) into IMC is expected, an IFR departure should be planned. However, standard masses and departures can be used when described in the operations manual.

- (5) The use of Category A data

In Category A procedures, TDP is the point at which either a rejected landing or a safe continuation of the flight, with OEI obstacle clearance, can be performed.

For PC2 (when using Category A data), only the safe forced landing (reject) distance depends on the equivalent of the TDP; if an engine fails between TDP and DPATO, the pilot has to decide what action is required. It is not necessary for a safe forced landing distance to be established from beyond the equivalent of TDP (see Figure 5 and discussion in (f)(2)(ii)(A)).

Category A procedures based on a fixed V_{TOSS} are usually optimised either for the reduction of the rejected take-off distance, or the take-off distance. Category A procedures based on a variable V_{TOSS} allow either a reduction in required distances (low V_{TOSS}) or an improvement in OEI climb capability (high V_{TOSS}). These optimisations may be beneficial in PC2 to satisfy the dimensions of the take-off site.

In view of the different requirements for PC2 (from PC1), it is perfectly acceptable for the two calculations (one to establish the safe forced landing distance and the other to establish DPATO) to be based upon different Category A procedures. However, if this method is used, the mass resulting from the calculation cannot be more than the mass from the more limiting of the procedures.

(6) DPATO and obstacle clearance

If it is necessary for OEI obstacle clearance to be established in the climb, the starting point (DPATO) for the (obstacle clearance) gradient has to be established. Once DPATO is defined, the OEI obstacle clearance is relatively easy to calculate with data from the AFM.

(i) DPATO based on AEO distance

In the simplest case; if provided, the scheduled AEO to 200 ft at V_y can be used (see Figure 7).

Figure 7

Suggested AEO locations for DPATO

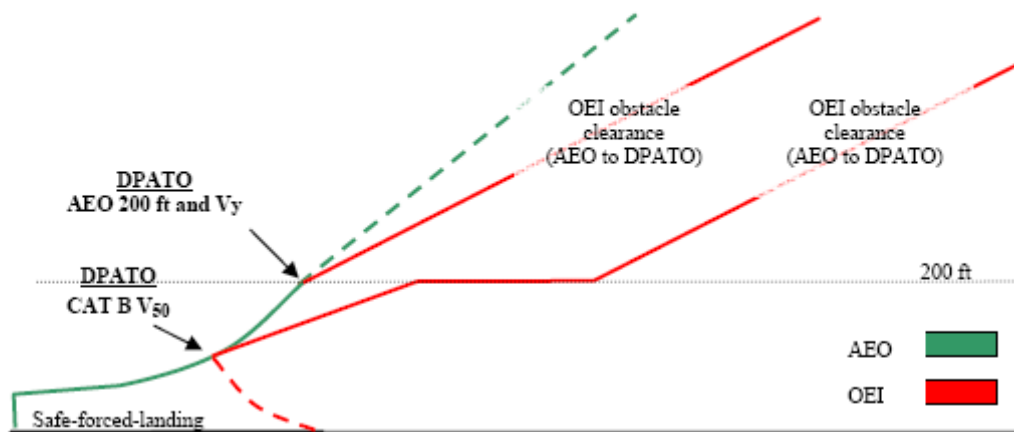

Otherwise, and if scheduled in the AFM, the AEO distance to 50 ft (V_{50}) — determined in accordance with CS/JAR 29.63 — can be used (see Figure 7). Where this distance is used, it will be necessary to ensure that the V_{50} climb out speed is associated with a speed and mass for which OEI climb data are available so that, from V_{50} , the OEI flight path can be constructed.

(ii) DPATO based on Category A distances

It is not necessary for specific AEO distances to be used (although for obvious reasons it is preferable); if they are not available, a flight path (with OEI obstacle clearance) can be established using Category A distances (see Figure 8 and Figure 9) — which will then be conservative.

Figure 8

Using Cat A data; actual and apparent position of DPATO (V_{toss} and start of first segment)

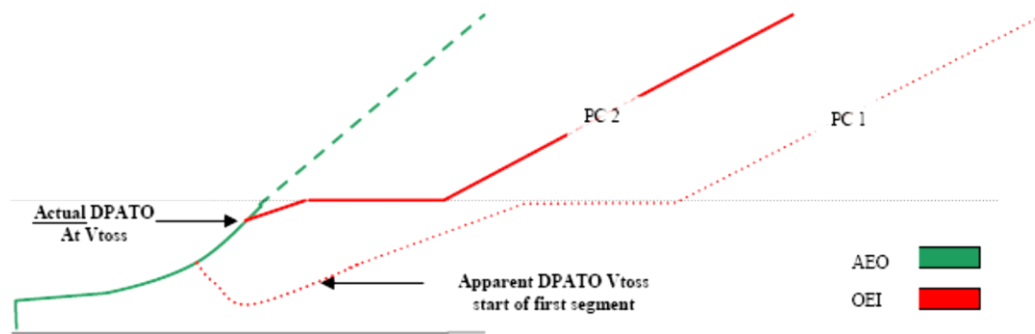

The apparent DPATO is for planning purposes only in the case where AEO data are not available to construct the take-off flight path. The actual OEI flight path will provide better obstacle clearance than the apparent one (used to demonstrate the minimum requirement) — as seen from the firm and dashed lines in the above figure.

Figure 9

Using Cat A data; actual and apparent position of DPATO (V_y and start of second segment)

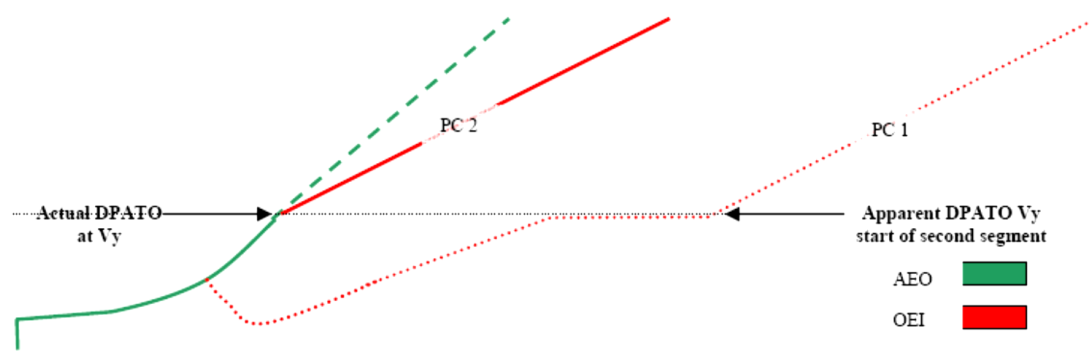

(iii) Use of most favourable Category A data

The use of AEO data are recommended for calculating DPATO. However, where an AEO distance is not provided in the flight manual, distance to V_y at 200 ft, from the most favourable of the Category A procedures, can be used to construct a flight path (provided it can be demonstrated that AEO distance to 200 ft at V_y is always closer to the take-off point than the CAT A OEI flight path).

In order to satisfy the requirement of CAT.POL.H.315, the last point from where the start of OEI obstacle clearance can be shown is at 200 ft.

(7) The calculation of DPATO — a summary

DPATO should be defined in terms of speed and height above the take-off surface and should be selected such that AFM data (or equivalent data) are available to establish the distance from the start of the take-off up to the DPATO (conservatively if necessary).

(i) First method

DPATO is selected as the AFM Category B take-off distance (V_{50} speed or any other take-off distance scheduled in accordance with CS/JAR 29.63) provided that within the distance the helicopter can achieve:

- (A) one of the V_{TOSS} values (or the unique V_{TOSS} value if it is not variable) provided in the AFM, selected so as to assure a climb capability according to Category A criteria; or
- (B) V_y .

Compliance with CAT.POL.H.315 would be shown from V_{50} (or the scheduled Category B take-off distance).

(ii) Second method

DPATO is selected as equivalent to the TDP of a Category A 'clear area' take-off procedure conducted in the same conditions.

Compliance with CAT.POL.H.315 would be shown from the point at which V_{TOSS} , a height of at least 35 ft above the take-off surface and a positive climb gradient are achieved (which is the Category A 'clear area' take-off distance).

Safe forced landing areas should be available from the start of the take-off, to a distance equal to the Category A 'clear area' rejected take-off distance.

(iii) Third method

As an alternative, DPATO could be selected such that AFM OEI data are available to establish a flight path initiated with a climb at that speed. This speed should then be:

- (A) one of the V_{TOSS} values (or the unique V_{TOSS} value if it is not variable) provided in the AFM, selected so as to assure a climb capability according to Category A criteria; or
- (B) V_y

The height of the DPATO should be at least 35 ft and can be selected up to 200 ft. Compliance with CAT.POL.H.315 would be shown from the selected height.

(8) Safe forced landing distance

Except as provided in (f)(7)(ii), the establishment of the safe forced landing distance could be problematical as it is not likely that PC2 specific data will be available in the AFM.

By definition, the Category A reject distance may be used when the surface is not suitable for a reject, but may be satisfactory for a safe forced landing (for example, where the surface is flooded or is covered with vegetation).

Any Category A (or other accepted) data may be used to establish the distance. However, once established, it remains valid only if the Category A mass (or the mass from the accepted data) is used and the Category A (or accepted) AEO profile to the TDP is flown. In view of these constraints, the likeliest Category A procedures are the clear area or the short field (restricted area/site) procedures.

From Figure 10, it can be seen that if the Category B V_{50} procedure is used to establish DPATO, the combination of the distance to 50 ft and the Category A 'clear area' landing distance, required by CS/JAR 29.81 (the horizontal distance required to land and come to a complete stop from a point 50 ft above the landing surface), will give a good indication of the maximum safe-forced-landing distance required (see also the explanation on V_{stayup} above).

Figure 10

Category B (V_{50}) safe–forced–landing distance

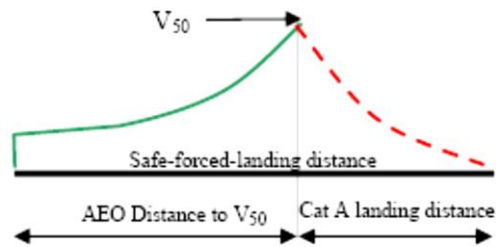

(9) Performance class 2 landing

For other than PC2 operations to elevated FATOs or helidecks (see section (g)(4)(i)), the principles for the landing case are much simpler. As the performance requirements for PC1 and PC2 landings are virtually identical, the condition of the landing surface is the main issue.

If the engine fails at any time during the approach, the helicopter must be able either: to perform a go-around meeting the requirements of CAT.POL.H.315; or perform a safe forced landing on the surface. In view of this, and if using PC1 data, the LDP should not be lower than the corresponding TDP (particularly in the case of a variable TDP).

The landing mass will be identical to the take-off mass for the same site (with consideration for any reduction due to obstacle clearance — as shown in Figure 6 above).

In the case of a balked landing (i.e. the landing site becomes blocked or unavailable during the approach), the full requirement for take-off obstacle clearance must be met.

(g) Operations in performance class 2 with exposure

The Implementing Rules offer an opportunity to discount the requirement for an assured safe forced landing area in the take-off or landing phase — subject to an approval from the competent authority. The following sections deal with this option:

(1) Limit of exposure

As stated above, performance class 2 has to ensure AEO obstacle clearance to DPATO and OEI obstacle clearance from that point. This does not change with the application of exposure.

It can, therefore, be stated that operations with exposure are concerned only with alleviation from the requirement for the provision of a safe forced landing.

The absolute limit of exposure is 200 ft — from which point OEI obstacle clearance must be shown.

(2) The principle of risk assessment

ICAO Annex 6 Part III Chapter 3.1.2 states that:

'3.1.2 In conditions where the safe continuation of flight is not ensured in the event of a critical engine failure, helicopter operations shall be conducted in a manner that gives appropriate consideration for achieving a safe forced landing.'

Although a safe forced landing may no longer be the (absolute) Standard, it is considered that risk assessment is obligatory to satisfy the amended requirement for 'appropriate consideration'.

Risk assessment used for fulfilment of this proposed Standard is consistent with principles described in 'AS/NZS 4360:1999'. Terms used in this text and defined in the AS/NZS Standard are shown in Sentence Case e.g. risk assessment or risk reduction.

(3) The application of risk assessment to performance class 2

Under circumstances where no risk attributable to engine failure (beyond that inherent in the safe forced landing) is present, operations in performance class 2 may be conducted in accordance with the non-alleviated requirements contained above — and a safe forced landing will be possible.

Under circumstances where such risk would be present, i.e. operations to an elevated FATO (deck edge strike); or, when permitted, operations from a site where a safe forced landing cannot be accomplished because the surface is inadequate; or where there is penetration into the HV curve for a short period during take-off or landing (a limitation in CS/JAR 29 AFMs), operations have to be conducted under a specific approval.

Provided such operations are risk assessed and can be conducted to an established safety target, they may be approved in accordance with CAT.POL.H.305.

(i) The elements of the risk management

The approval process consists of an operational risk assessment and the application of four principles:

- (A) a safety target;
- (B) a helicopter reliability assessment;
- (C) continuing airworthiness; and
- (D) mitigating procedures.

(ii) The safety target

The main element of the risk assessment when exposure was initially introduced by the JAA into JAR-OPS 3 (NPA OPS-8), was the assumption that turbine engines in helicopters would have failure rates of about 1:100 000 per flying hour, which would permit (against the agreed safety target of 5×10^{-8} per event) an exposure of about 9 seconds for twins during the take-off or landing event. (When choosing this target it was assumed that the majority of current well-maintained turbine powered helicopters would be capable of meeting the event target — it, therefore, represents the residual risk).

(Residual risk is considered to be the risk that remains when all mitigating procedures — airworthiness and operational — are applied (see sections (g)(3)(iv) and (g)(3)(v))).

(iii) The reliability assessment

The reliability assessment was initiated to test the hypothesis (stated in (g)(3)(ii)) that the majority of turbine powered types would be able to meet the safety target. This hypothesis could only be confirmed by an examination of the manufacturers' power-loss data.

(iv) Mitigating procedures (airworthiness)

Mitigating procedures consist of a number of elements:

- (A) the fulfilment of all manufacturers' safety modifications;
- (B) a comprehensive reporting system (both failures and usage data); and
- (C) the implementation of a usage monitoring system (UMS).

Each of these elements is to ensure that engines, once shown to be sufficiently reliable to meet the safety target, will sustain such reliability (or improve upon it).

The monitoring system is felt to be particularly important as it had already been demonstrated that when such systems are in place it inculcates a more considered approach to operations. In addition, the elimination of ‘hot starts’, prevented by the UMS, itself minimises the incidents of turbine burst failures.

(v) Mitigating procedures (operations)

Operational and training procedures, to mitigate the risk — or minimise the consequences — are required of the operator. Such procedures are intended to minimise risk by ensuring that:

- (A) the helicopter is operated within the exposed region for the minimum time; and
- (B) simple but effective procedures are followed to minimise the consequence should an engine failure occur.

(4) Operation with exposure

When operating with exposure, there is alleviation from the requirement to establish a safe forced landing area (which extends to landing as well as take-off). However, the requirement for obstacle clearance — AEO in the take-off and from DPATO OEI in the climb and en-route phases — remains (both for take-off and landing).

The take-off mass is obtained from the more limiting of the following:

- the climb performance of 150 ft/min at 1 000 ft above the take-off point; or
- obstacle clearance (in accordance with (f)(3) above); or
- AEO hover out of ground effect (HOGE) performance at the appropriate power setting. (AEO HOGE is required to ensure acceleration when (near) vertical dynamic take-off techniques are being used. Additionally, for elevated FATO or helidecks, it ensures a power reserve to offset ground cushion dissipation; and ensures that, during the landing manoeuvre, a stabilised HOGE is available — should it be required.)

(i) Operations to elevated FATOs or helidecks

PC2 operations to elevated FATOs and helidecks are a specific case of operations with exposure. In these operations, the alleviation covers the possibility of:

- (A) a deck-edge strike if the engine fails early in the take-off or late in the landing;
- (B) penetration into the HV Curve during take-off and landing; and
- (C) forced landing with obstacles on the surface (hostile water conditions) below the elevated FATO (helideck). The take-off mass is as stated above and relevant techniques are as described in GM1 CAT.POL.H.310(c) & CAT.POL.H.325(c).

It is unlikely that the DPATO will have to be calculated with operations to helidecks (due to the absence of obstacles in the take-off path).

(ii) Additional requirements for operations to helidecks in a hostile environment

For a number of reasons (e.g. the deck size, and the helideck environment — including obstacles and wind vectors), it was not anticipated that operations in PC1 would be technically feasible or economically justifiable by the projected JAA deadline of 2010 (OEI HOGE could have provided a method of compliance, but this would have resulted in a severe and unwarranted restriction on payload/range).

However, due to the severe consequences of an engine failure to helicopters involved in take-off and landings to helidecks located in hostile sea areas (such as the North Sea or the North Atlantic), a policy of risk reduction is called for. As a result, enhanced class 2 take-off and landing masses together with techniques that provide a high confidence of safety due to:

- (A) deck-edge avoidance; and
 - (B) drop-down that provides continued flight clear of the sea,
- are seen as practical measures.

For helicopters which have a Category A elevated helideck procedure, certification is satisfied by demonstrating a procedure and adjusted masses (adjusted for wind as well as temperature and pressure) that assure a 15-ft deck edge clearance on take-off and landing. It is, therefore, recommended that manufacturers, when providing enhanced PC2 procedures, use the provision of this deck-edge clearance as their benchmark.

As the height of the helideck above the sea is a variable, drop down has to be calculated; once clear of the helideck, a helicopter operating in PC1 would be expected to meet the 35-ft obstacle clearance. Under circumstances other than open sea areas and with less complex environmental conditions, this would not present difficulties. As the provision of drop down takes no account of operational circumstances, standard drop down graphs for enhanced PC2 — similar to those in existence for Category A procedures — are anticipated.

Under conditions of offshore operations, calculation of drop down is not a trivial matter — the following examples indicate some of the problems which might be encountered in hostile environments:

- (A) Occasions when tide is not taken into account and the sea is running irregularly — the level of the obstacle (i.e. the sea) is indefinable making a true calculation of drop down impossible.
- (B) Occasions when it would not be possible — for operational reasons — for the approach and departure paths to be clear of obstacles — the 'standard' calculation of drop-down could not be applied.

Under these circumstances, practicality indicates that drop down should be based upon the height of the deck AMSL and the 35-ft clearance should be applied.

There are, however, other and more complex issues which will also affect the deck-edge clearance and drop down calculations.

- (C) When operating to moving decks on vessels, a recommended landing or take-off profile might not be possible because the helicopter might have to hover alongside in order that the rise and fall of the ship is mentally mapped; or, on take-off re-landing in the case of an engine failure might not be an option.

Under these circumstances, the commander might adjust the profiles to address a hazard more serious or more likely than that presented by an engine failure.

It is because of these and other (unforeseen) circumstances that a prescriptive requirement is not used. However, the target remains a 15-ft deck-edge clearance

and a 35-ft obstacle clearance and data should be provided such that, where practically possible, these clearances can be planned.

As accident/incident history indicates that the main hazard is collision with obstacles on the helideck due to human error, simple and reproducible take-off and landing procedures are recommended.

In view of the reasons stated above, the future requirement for PC1 was replaced by the new requirement that the take-off mass takes into account:

- the procedure;
- deck-edge miss; and
- drop down appropriate to the height of the helideck.

This will require calculation of take-off mass from information produced by manufacturers reflecting these elements. It is expected that such information will be produced by performance modelling/simulation using a model validated through limited flight testing.

- (iii) Operations to helidecks for helicopters with a maximum operational passenger seating configuration (MOPSC) of more than 19

The original requirement for operations of helicopters with an MOPSC of more than 19 was PC1 (as set out in CAT.POL.H.100 (b)(2)).

However, when operating to helidecks, the problems enumerated in (g)(4)(ii) above are equally applicable to these helicopters. In view of this, but taking into account that increased numbers are (potentially) being carried, such operations are permitted in PC2 (CAT.POL.H.100 (b)(2)) but, in all helideck environments (both hostile and non-hostile), have to satisfy, the additional requirements, set out in (g)(4)(ii) above.

CAT.POL.H.305 Operations without an assured safe forced landing capability

- (a) Operations without an assured safe forced landing capability during the take-off and landing phases shall only be conducted if the operator has been granted an approval by the competent authority.
- (b) To obtain and maintain such approval the operator shall:
- (1) conduct a risk assessment, specifying:
 - (i) the type of helicopter; and
 - (ii) the type of operations;
 - (2) implement the following set of conditions:
 - (i) attain and maintain the helicopter/engine modification standard defined by the manufacturer;
 - (ii) conduct the preventive maintenance actions recommended by the helicopter or engine manufacturer;
 - (iii) include take-off and landing procedures in the operations manual, where they do not already exist in the AFM;
 - (iv) specify training for flight crew; and
 - (v) provide a system for reporting to the manufacturer loss of power, engine shutdown or engine failure events;and
 - (3) implement a usage monitoring system (UMS).

Applicable
from
01/07/2018.

AMC1 CAT.POL.H.305(a) Operations without an assured safe forced landing capability

VALIDITY OF THE RISK ASSESSMENT

The operator should periodically review and update the procedures and associated risk assessments, pertaining to the granting of the CAT.POL.H.305(a) approval, to ensure that they are adequate and remain relevant for the operation.

AMC1 CAT.POL.H.305(b) Helicopter operations without an assured safe forced landing capability

ENGINE RELIABILITY STATISTICS

- (a) As part of the risk assessment prior to granting an approval under CAT.POL.H.305, the operator should provide appropriate engine reliability statistics available for the helicopter type and the engine type.
- (b) Except in the case of new engines, such data should show sudden power loss from the set of in-flight shutdown (IFSD) events not exceeding 1 per 100 000 engine hours in a 5 year moving window. However, a rate in excess of this value, but not exceeding 3 per 100 000 engine hours, may be accepted by the competent authority after an assessment showing an improving trend.
- (c) New engines should be assessed on a case-by-case basis.
- (d) After the initial assessment, updated statistics should be periodically reassessed; any adverse sustained trend will require an immediate evaluation to be accomplished by the operator in consultation with the competent authority and the manufacturers concerned. The evaluation may result in corrective action or operational restrictions being applied.

(e) The purpose of this paragraph is to provide guidance on how the in-service power plant sudden power loss rate is determined.

(1) Share of roles between the helicopter and engine type certificate holders (TCH)

- (i) The provision of documents establishing the in-service sudden power loss rate for the helicopter/engine installation; the interface with the operational authority of the State of the operator should be the engine TCH or the helicopter TCH depending on the way they share the corresponding analysis work.
- (ii) The engine TCH should provide the helicopter TCH with a document including: the list of in-service power loss events, the applicability factor for each event (if used), and the assumptions made on the efficiency of any corrective actions implemented (if used).
- (iii) The engine or helicopter TCH should provide the operational authority of the State of the operator, with a document that details the calculation results taking into account the following:
 - (A) events caused by the engine and the events caused by the engine installation;
 - (B) applicability factor for each event (if used), the assumptions made on the efficiency of any corrective actions implemented on the engine and on the helicopter (if used); and
 - (C) calculation of the power plant power loss rate.

(2) Documentation

The following documentation should be updated every year:

- (i) the document with detailed methodology and calculation as distributed to the authority of the State of design;
- (ii) a summary document with results of computation as made available on request to any operational authority; and
- (iii) a service letter establishing the eligibility for such operation and defining the corresponding required configuration as provided to the operators.

(3) Definition of 'sudden in-service power loss'

Sudden in-service power loss is an engine power loss:

- (i) larger than 30 % of the take-off power;
- (ii) occurring during operation; and
- (iii) without the occurrence of an early intelligible warning to inform and give sufficient time for the pilot to take any appropriate action.

(4) Database documentation

Each power loss event should be documented, by the engine and/or helicopter TCHs, as follows:

- (i) incident report number;
- (ii) engine type;
- (iii) engine serial number;
- (iv) helicopter serial number;

- (v) date;
 - (vi) event type (demanded IFSD, un-demanded IFSD);
 - (vii) presumed cause;
 - (viii) applicability factor when used; and
 - (ix) reference and assumed efficiency of the corrective actions that will have to be applied (if any).
- (5) Counting methodology

Various methodologies for counting engine power loss rate have been accepted by authorities. The following is an example of one of these methodologies.

- (i) The events resulting from:
 - (A) unknown causes (wreckage not found or totally destroyed, undocumented or unproven statements);
 - (B) where the engine or the elements of the engine installation have not been investigated (for example, when the engine has not been returned by the customer); or
 - (C) an unsuitable or non-representative use (operation or maintenance) of the helicopter or the engine,are not counted as engine in-service sudden power loss and the applicability factor is 0 %.
 - (ii) The events caused by:
 - (A) the engine or the engine installation; or
 - (B) the engine or helicopter maintenance, when the applied maintenance was compliant with the maintenance manuals,are counted as engine in-service sudden power loss and the applicability factor is 100 %.
 - (iii) For the events where the engine or an element of the engine installation has been submitted for investigation, but where this investigation subsequently failed to define a presumed cause, the applicability factor is 50 %.
- (6) Efficiency of corrective actions

The corrective actions made by the engine and helicopter manufacturers on the definition or maintenance of the engine or its installation may be defined as mandatory for specific operations. In this case, the associated reliability improvement may be considered as a mitigating factor for the event.

A factor defining the efficiency of the corrective action may be applied to the applicability factor of the concerned event.

- (7) Method of calculation of the power plant power loss rate

The detailed method of calculation of the power plant power loss rate should be documented by engine or helicopter TCH and accepted by the relevant authority.

AMC2 CAT.POL.H.305(b) Helicopter operations without an assured safe forced landing capability

IMPLEMENTATION OF THE SET OF CONDITIONS

To obtain an approval under CAT.POL.H.305(a), the operator conducting operations without an assured safe forced landing capability should implement the following:

- (a) Attain and then maintain the helicopter/engine modification standard defined by the manufacturer that has been designated to enhance reliability during the take-off and landing phases.
- (b) Conduct the preventive maintenance actions recommended by the helicopter or engine manufacturer as follows:
 - (1) engine oil spectrometric and debris analysis — as appropriate;
 - (2) engine trend monitoring, based on available power assurance checks;
 - (3) engine vibration analysis (plus any other vibration monitoring systems where fitted); and
 - (4) oil consumption monitoring.
- (c) The usage monitoring system should fulfil at least the following:
 - (1) Recording of the following data:
 - (i) date and time of recording, or a reliable means of establishing these parameters;
 - (ii) amount of flight hours recorded during the day plus total flight time;
 - (iii) N₁ (gas producer RPM) cycle count;
 - (iv) N₂ (power turbine RPM) cycle count (if the engine features a free turbine);
 - (v) turbine temperature exceedance: value, duration;
 - (vi) power-shaft torque exceedance: value, duration (if a torque sensor is fitted);
 - (vii) engine shafts speed exceedance: value, duration.
 - (2) Data storage of the above parameters, if applicable, covering the maximum flight time in a day, and not less than 5 flight hours, with an appropriate sampling interval for each parameter.
 - (3) The system should include a comprehensive self-test function with a malfunction indicator and a detection of power-off or sensor input disconnection.
 - (4) A means should be available for downloading and analysis of the recorded parameters. Frequency of downloading should be sufficient to ensure data are not lost through overwriting.
 - (5) The analysis of parameters gathered by the usage monitoring system, the frequency of such analysis and subsequent maintenance actions should be described in the maintenance documentation.
 - (6) The data should be stored in an acceptable form and accessible to the competent authority for at least 24 months.
- (d) The training for flight crew should include the discussion, demonstration, use and practice of the techniques necessary to minimise the risks.
- (e) Report to the manufacturer any loss of power control, engine shutdown (precautionary or otherwise) or engine failure for any cause (excluding simulation of engine failure during training). The content of each report should provide:

- (1) date and time;
- (2) operator (and maintenance organisations where relevant);
- (3) type of helicopter and description of operations;
- (4) registration and serial number of airframe;
- (5) engine type and serial number;
- (6) power unit modification standard where relevant to failure;
- (7) engine position;
- (8) symptoms leading up to the event;
- (9) circumstances of engine failure including phase of flight or ground operation;
- (10) consequences of the event;
- (11) weather/environmental conditions;
- (12) reason for engine failure — if known;
- (13) in case of an in-flight shutdown (IFSD), nature of the IFSD (demanded/un-demanded);
- (14) procedure applied and any comment regarding engine restart potential;
- (15) engine hours and cycles (from new and last overhaul);
- (16) airframe flight hours;
- (17) rectification actions applied including, if any, component changes with part number and serial number of the removed equipment; and
- (18) any other relevant information.

GM1 CAT.POL.H.305(b) Helicopter operations without an assured safe forced landing capability

USE OF FULL AUTHORITY DIGITAL ENGINE CONTROL (FADEC)

Current technology increasingly allows for the recording function required in (c)(1) of AMC2 CAT.POL.H.305(b) to be incorporated in the full authority digital engine control (FADEC).

Where a FADEC is capable of recording some of the parameters required by (c)(1) of AMC2 CAT.POL.H.305(b), it is not intended that the recording of the parameters is to be duplicated.

Providing that the functions as set out in (c) of AMC2 CAT.POL.H.305(b) are satisfied, the FADEC may partially, or in whole, fulfil the requirement for recording and storing parameters in a usage monitoring system.

CAT.POL.H.310 Take-off

- (a) The take-off mass shall not exceed the maximum mass specified for a rate of climb of 150 ft/min at 300 m (1 000 ft) above the level of the aerodrome or operating site with the critical engine inoperative and the remaining engine(s) operating at an appropriate power rating.
- (b) For operations other than those specified in CAT.POL.H.305, the take-off shall be conducted such that a safe forced landing can be executed until the point where safe continuation of the flight is possible.
- (c) For operations in accordance with CAT.POL.H.305, in addition to the requirements of (a):
- (1) the take-off mass shall not exceed the maximum mass specified in the AFM for an all engines operative out of ground effect (AEO OGE) hover in still air with all engines operating at an appropriate power rating; or
 - (2) for operations from a helideck:
 - (i) with a helicopter that has an MOPSC of more than 19; or
 - (ii) any helicopter operated from a helideck located in a hostile environment,the take-off mass shall take into account: the procedure; deck-edge miss and drop down appropriate to the height of the helideck with the critical engine(s) inoperative and the remaining engines operating at an appropriate power rating.
- (d) When showing compliance with (a) to (c), account shall be taken of the appropriate parameters of CAT.POL.H.105(c) at the point of departure.
- (e) That part of the take-off before the requirement of CAT.POL.H.315 is met shall be conducted in sight of the surface.

GM1 CAT.POL.H.310(c) & CAT.POL.H.325(c) Take-off and landing

PROCEDURE FOR CONTINUED OPERATIONS TO HELIDECKS

- (a) Factors to be considered when taking off from or landing on a helideck
- (1) In order to take account of the considerable number of variables associated with the helideck environment, each take-off and landing may require a slightly different profile. Factors such as helicopter mass and centre of gravity, wind velocity, turbulence, deck size, deck elevation and orientation, obstructions, power margins, platform gas turbine exhaust plumes etc., will influence both the take-off and landing. In particular, for the landing, additional considerations such as the need for a clear go-around flight path, visibility and cloud base, etc. will affect the commander's decision on the choice of landing profile. Profiles may be modified, taking account of the relevant factors noted above and the characteristics of individual helicopter types.
- (b) Performance
- (1) To perform the following take-off and landing profiles, adequate all engines operating (AEO) hover performance at the helideck is required. In order to provide a minimum level of performance, data (derived from the AFM AEO out of ground effect (OGE)) should be used to provide the maximum take-off or landing mass. Where a helideck is affected by downdrafts or turbulence or hot gases, or where the take-off or landing profile is obstructed, or the approach or take-off cannot be made into wind, it may be necessary to decrease this take-off or landing mass by using a suitable calculation method. The helicopter mass should not exceed that required by CAT.POL.H.310(a) or CAT.POL.H.325(a).

(For helicopter types no longer supported by the manufacturer, data may be established by the operator, provided it is acceptable to the competent authority.)

(c) Take-off profile

- (1) The take-off should be performed in a dynamic manner ensuring that the helicopter continuously moves vertically from the hover to the rotation point (RP) and thence into forward flight. If the manoeuvre is too dynamic, then there is an increased risk of losing spatial awareness (through loss of visual cues) in the event of a rejected take-off, particularly at night.
- (2) If the transition to forward flight is too slow, the helicopter is exposed to an increased risk of contacting the deck edge in the event of an engine failure at or just after the point of cyclic input (RP).
- (3) It has been found that the climb to RP is best made between 110 % and 120 % of the power required in the hover. This power offers a rate of climb that assists with deck-edge clearance following engine failure at RP, whilst minimising ballooning following a failure before RP. Individual types will require selection of different values within this range.

Figure 1

Take-off profile

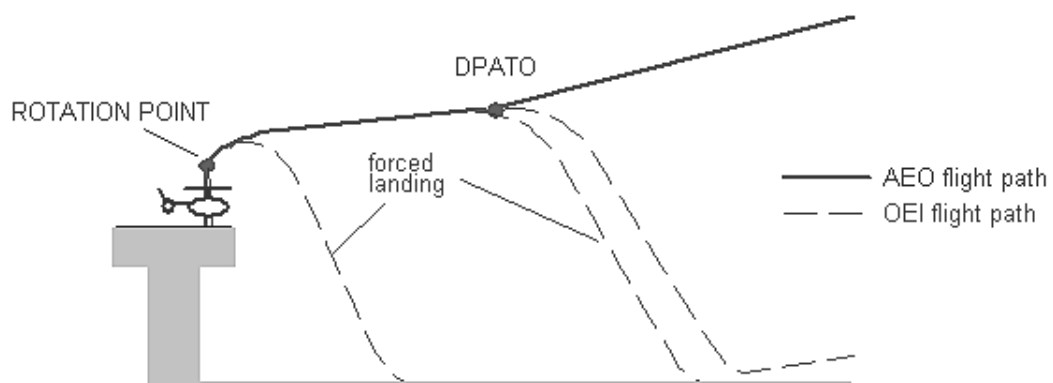

(d) Selection of a lateral visual cue

- (1) In order to obtain the maximum performance in the event of an engine failure being recognised at or just after RP, the RP should be at its optimum value, consistent with maintaining the necessary visual cues. If an engine failure is recognised just before RP, the helicopter, if operating at a low mass, may 'balloon' a significant height before the reject action has any effect. It is, therefore, important that the pilot flying selects a lateral visual marker and maintains it until the RP is achieved, particularly on decks with few visual cues. In the event of a rejected take-off, the lateral marker will be a vital visual cue in assisting the pilot to carry out a successful landing.

(e) Selection of the rotation point

- (1) The optimum RP should be selected to ensure that the take-off path will continue upwards and away from the deck with AEO, but minimising the possibility of hitting the deck edge due to the height loss in the event of an engine failure at or just after RP.
- (2) The optimum RP may vary from type to type. Lowering the RP will result in a reduced deck edge clearance in the event of an engine failure being recognised at or just after RP. Raising the RP will result in possible loss of visual cues, or a hard landing in the event of an engine failure just prior to RP.

(f) Pilot reaction times

-
- (1) Pilot reaction time is an important factor affecting deck edge clearance in the event of an engine failure prior to or at RP. Simulation has shown that a delay of 1 second can result in a loss of up to 15 ft in deck edge clearance.
 - (g) Variation of wind speed
 - (1) Relative wind is an important parameter in the achieved take-off path following an engine failure; wherever practicable, take-off should be made into wind. Simulation has shown that a 10-kt wind can give an extra 5-ft deck edge clearance compared to a zero wind condition.
 - (h) Position of the helicopter relative to the deck edge
 - (1) It is important to position the helicopter as close to the deck edge (including safety nets) as possible whilst maintaining sufficient visual cues, particularly a lateral marker.
 - (2) The ideal position is normally achieved when the rotor tips are positioned at the forward deck edge. This position minimises the risk of striking the deck edge following recognition of an engine failure at or just after RP. Any take-off heading which causes the helicopter to fly over obstructions below and beyond the deck edge should be avoided if possible. Therefore, the final take-off heading and position will be a compromise between the take-off path for least obstructions, relative wind, turbulence and lateral marker cue considerations.
 - (i) Actions in the event of an engine failure at or just after RP
 - (1) Once committed to the continued take-off, it is important, in the event of an engine failure, to rotate the aircraft to the optimum attitude in order to give the best chance of missing the deck edge. The optimum pitch rates and absolute pitch attitudes should be detailed in the profile for the specific type.
 - (j) Take-off from helidecks that have significant movement
 - (1) This technique should be used when the helideck movement and any other factors, e.g. insufficient visual cues, makes a successful rejected take-off unlikely. Weight should be reduced to permit an improved one-engine-inoperative capability, as necessary.
 - (2) The optimum take-off moment is when the helideck is level and at its highest point, e.g. horizontal on top of the swell. Collective pitch should be applied positively and sufficiently to make an immediate transition to climbing forward flight. Because of the lack of a hover, the take-off profile should be planned and briefed prior to lift off from the deck.
 - (k) Standard landing profile
 - (1) The approach should be commenced into wind to a point outboard of the helideck. Rotor tip clearance from the helideck edge should be maintained until the aircraft approaches this position at the requisite height (type dependent) with approximately 10 kt of ground-speed and a minimal rate of descent. The aircraft is then flown on a flight path to pass over the deck edge and into a hover over the safe landing area.

Figure 2

Standard landing profile

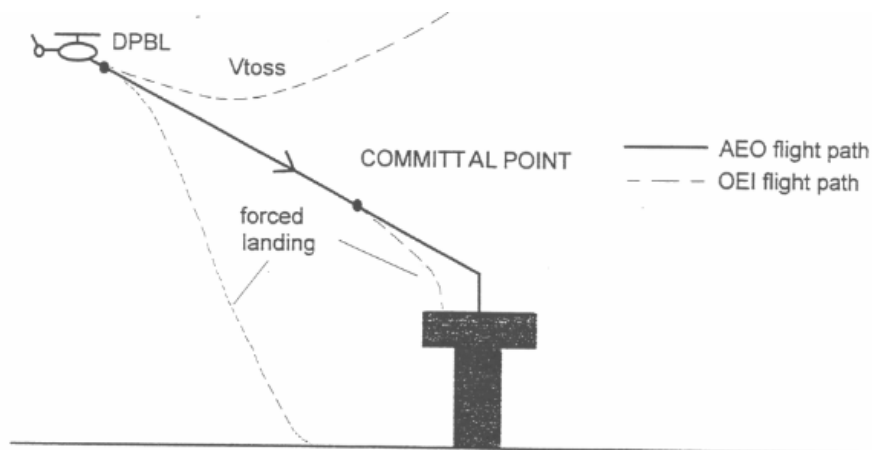

(l) Offset landing profile

- (1) If the normal landing profile is impracticable due to obstructions and the prevailing wind velocity, the offset procedure may be used. This should involve flying to a hover position, approximately 90° offset from the landing point, at the appropriate height and maintaining rotor tip clearance from the deck edge. The helicopter should then be flown slowly but positively sideways and down to position in a low hover over the landing point. Normally, the committal point (CP) will be the point at which helicopter begins to transition over the helideck edge.

(m) Training

- (1) These techniques should be covered in the training required by Annex III (Part-ORO).

GM1 CAT.POL.H.310 & CAT.POL.H.325 Take-off and landing

TAKE-OFF AND LANDING TECHNIQUES

- (a) This GM describes three types of operation to/from helidecks and elevated FATOs by helicopters operating in performance class 2.
- (b) In two cases of take-off and landing, exposure time is used. During the exposure time (which is only approved for use when complying with CAT.POL.H.305), the probability of an engine failure is regarded as extremely remote. If an engine failure occurs during the exposure time, a safe forced landing may not be possible.
- (c) Take-off — non-hostile environment (without an approval to operate with an exposure time) CAT.POL.H.310(b).
 - (1) Figure 1 shows a typical take-off profile for performance class 2 operations from a helideck or an elevated FATO in a non-hostile environment.
 - (2) If an engine failure occurs during the climb to the rotation point, compliance with CAT.POL.H.310(b) will enable a safe landing or a safe forced landing on the deck.
 - (3) If an engine failure occurs between the rotation point and the DPATO, compliance with CAT.POL.H.310(b) will enable a safe forced landing on the surface, clearing the deck edge.
 - (4) At or after the DPATO, the OEI flight path should clear all obstacles by the margins specified in CAT.POL.H.315.

Figure 1

Typical take-off profile PC2 from a helideck/elevated FATO, non-hostile environment

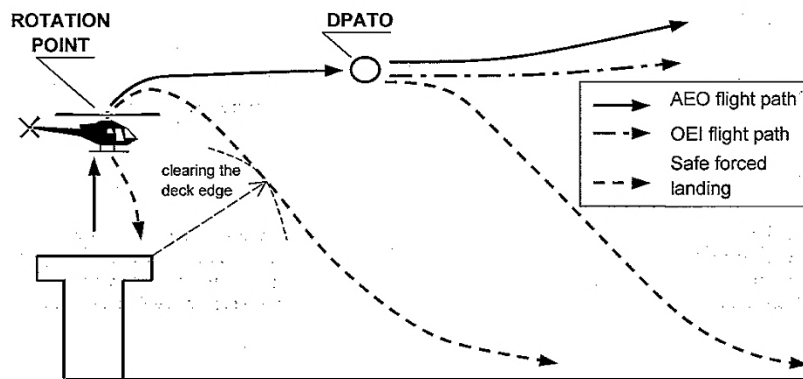

(d) Take-off — non-hostile environment (with exposure time) CAT.POL.H.310(c)

- (1) Figure 2 shows a typical take-off profile for performance class 2 operations from a helideck or an elevated FATO in a non-hostile environment (with exposure time).
- (2) If an engine failure occurs after the exposure time and before DPATO, compliance with CAT.POL.H.310(c) will enable a safe forced landing on the surface.
- (3) At or after the DPATO, the OEI flight path should clear all obstacles by the margins specified in CAT.POL.H.315.

Figure 2

Typical take-off profile PC2 from a helideck/elevated FATO with exposure time, non-hostile environment

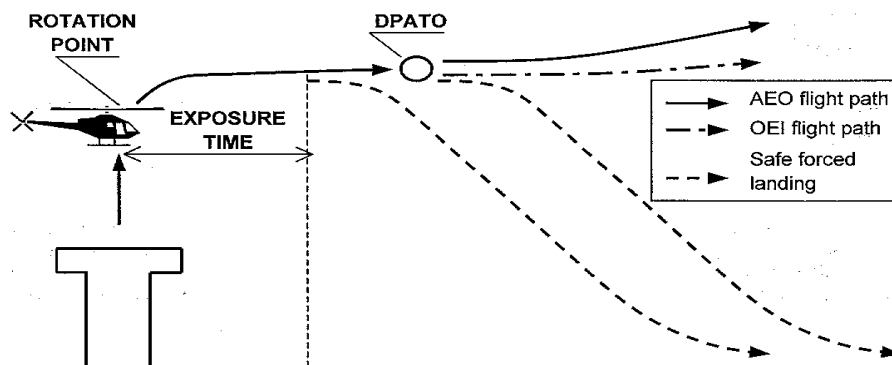

(e) Take-off — non-congested hostile environment (with exposure time) CAT.POL.H.310(c)

- (1) Figure 3 shows a typical take off profile for performance class 2 operations from a helideck or an elevated FATO in a non-congested hostile environment (with exposure time).
- (2) If an engine failure occurs after the exposure time, the helicopter is capable of a safe forced landing or safe continuation of the flight.
- (3) At or after the DPATO, the OEI flight path should clear all obstacles by the margins specified in CAT.POL.H.315.

Figure 3

Typical take-off profile PC2 from a helideck/elevated FATO, non-congested hostile environment

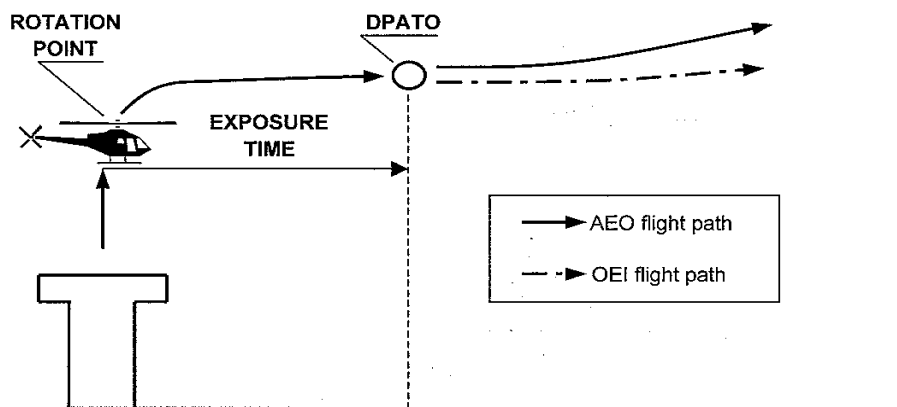

(f) Landing — non-hostile environment (without an approval to operate with an exposure time) CAT.POL.H.325 (b)

- (1) Figure 4 shows a typical landing profile for performance class 2 operations to a helideck or an elevated FATO in a non-hostile environment.
- (2) The DPBL is defined as a 'window' in terms of airspeed, rate of descent, and height above the landing surface. If an engine failure occurs before the DPBL, the pilot may elect to land or to execute a bailed landing.
- (3) In the event of an engine failure being recognised after the DPBL and before the committal point, compliance with CAT.POL.H.325(b) will enable a safe forced landing on the surface.
- (4) In the event of an engine failure at or after the committal point, compliance with CAT.POL.H.325(b) will enable a safe forced landing on the deck.

Figure 4

Typical landing profile PC2 to a helideck/elevated FATO, non-hostile environment

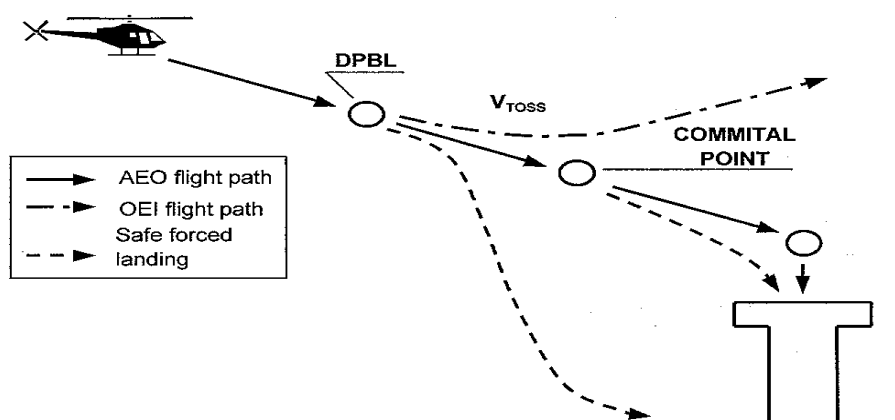

(g) Landing — non-hostile environment (with exposure time) CAT.POL.H.325 (c)

- (1) Figure 5 shows a typical landing profile for performance class 2 operations to a helideck or an elevated FATO in a non-hostile environment (with exposure time).

- (2) The DPBL is defined as a ‘window’ in terms of airspeed, rate of descent, and height above the landing surface. If an engine failure occurs before the DPBL, the pilot may elect to land or to execute a bailed landing.
- (3) In the event of an engine failure being recognised before the exposure time, compliance with CAT.POL.H.325(c) will enable a safe forced landing on the surface.
- (4) In the event of an engine failure after the exposure time, compliance with CAT.POL.H.325(c) will enable a safe forced landing on the deck.

Figure 5

Typical landing profile PC2 to a helideck/elevated FATO with exposure time, non-hostile environment

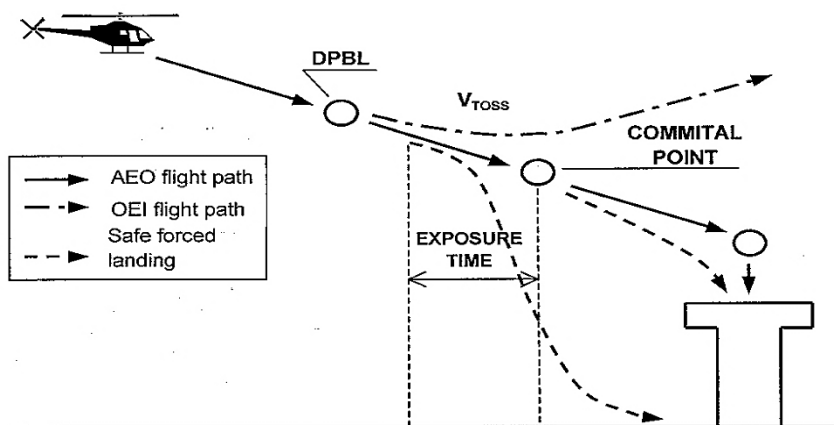

(h) Landing — non-congested hostile environment (with exposure time) CAT.POL.H.325(c)

- (1) Figure 6 shows a typical landing profile for performance class 2 operations to a helideck or an elevated FATO in a non-congested hostile environment (with exposure time).
- (2) In the event of an engine failure at any point during the approach and landing phase up to the start of exposure time, compliance with CAT.POL.H.325(b) will enable the helicopter, after clearing all obstacles under the flight path, to continue the flight.
- (3) In the event of an engine failure after the exposure time (i.e. at or after the committal point), a safe forced landing should be possible on the deck.

Figure 6

Typical landing profile PC2 to a helideck/elevated FATO with exposure time, non-congested hostile environment

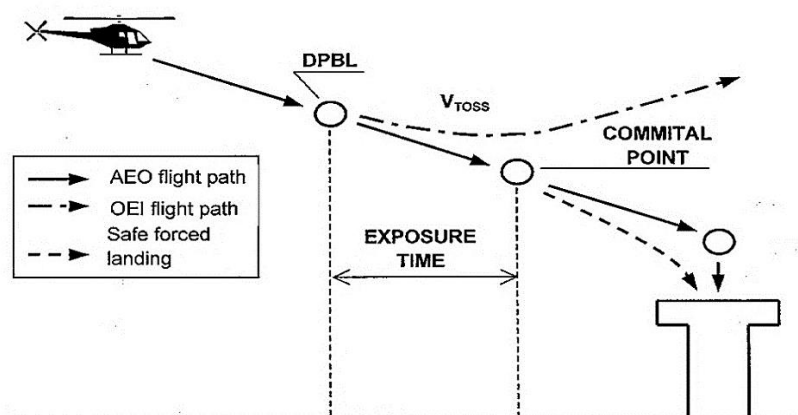

Applicable
from
01/07/2018.

AMC1 CAT.POL.H.310(c)(2) and CAT.POL.H.325(c)(2) Take-off and landing**FACTORS**

- (a) To ensure that the necessary factors are taken into account, the operator should:
- (1) use take-off and landing procedures that are appropriate to the circumstances, and that minimise the risks of collision with obstacles at the individual offshore location under the prevailing conditions; and
 - (2) use the aircraft flight manual (AFM) performance data or, where such data is not available, alternative data approved by the competent authority, which show take-off and landing masses that take into account drop-down and take-off deck-edge miss, under varying conditions of pressure altitude, temperature, and wind.
- (b) Replanning of offshore location take-off or landing masses during the flight should only be performed in accordance with procedures established in the operations manual (OM). These procedures should be simple and safe to carry out, with no significant increase in the crew workload during critical phases of the flight.

CAT.POL.H.315 Take-off flight path

From the defined point after take-off (DPATO) or, as an alternative, no later than 200 ft above the take-off surface, with the critical engine inoperative, the requirements of CAT.POL.H.210(a)(1), (a)(2) and (b) shall be complied with.

CAT.POL.H.320 En-route — critical engine inoperative

The requirement of CAT.POL.H.215 shall be complied with.

CAT.POL.H.325 Landing

- (a) The landing mass at the estimated time of landing shall not exceed the maximum mass specified for a rate of climb of 150 ft/min at 300 m (1 000 ft) above the level of the aerodrome or operating site with the critical engine inoperative and the remaining engine(s) operating at an appropriate power rating.
- (b) If the critical engine fails at any point in the approach path:
 - (1) a balked landing can be carried out meeting the requirement of CAT.POL.H.315; or
 - (2) for operations other than those specified in CAT.POL.H.305, the helicopter can perform a safe forced landing.
- (c) For operations in accordance with CAT.POL.H.305, in addition to the requirements of (a):
 - (1) the landing mass shall not exceed the maximum mass specified in the AFM for an AEO OGE hover in still air with all engines operating at an appropriate power rating; or
 - (2) for operations to a helideck:
 - (i) with a helicopter that has an MOPSC of more than 19; or
 - (ii) any helicopter operated to a helideck located in a hostile environment,the landing mass shall take into account the procedure and drop down appropriate to the height of the helideck with the critical engine inoperative and the remaining engine(s) operating at an appropriate power rating.
- (d) When showing compliance with (a) to (c), account shall be taken of the appropriate parameters of CAT.POL.H.105(c) at the destination aerodrome or any alternate, if required.
- (e) That part of the landing after which the requirement of (b)(1) cannot be met shall be conducted in sight of the surface.

GM1 CAT.POL.H.310 & CAT.POL.H.325 Take-off and landing

See [here](#).

CHAPTER 4
Performance class 3**CAT.POL.H.400 General**

- (a) Helicopters operated in performance class 3 shall be certified in category A or equivalent as determined by the Agency, or category B.
- (b) Operations shall only be conducted in a non-hostile environment, except:
 - (1) when operating in accordance with CAT.POL.H.420; or
 - (2) for the take-off and landing phase, when operating in accordance with (c).
- (c) Provided the operator is approved in accordance with CAT.POL.H.305, operations may be conducted to/from an aerodrome or operating site located outside a congested hostile environment without an assured safe forced landing capability:
 - (1) during take-off, before reaching V_y (speed for best rate of climb) or 200 ft above the take-off surface; or
 - (2) during landing, below 200 ft above the landing surface.
- (d) Operations shall not be conducted:
 - (1) out of sight of the surface;
 - (2) at night;
 - (3) when the ceiling is less than 600 ft; or
 - (4) when the visibility is less than 800 m.

GM1 CAT.POL.H.400(c) General

THE TAKE-OFF AND LANDING PHASES (PERFORMANCE CLASS 3)

- (a) To understand the use of ground level exposure in performance class 3, it is important first to be aware of the logic behind the use of 'take-off and landing phases'. Once this is clear, it is easier to appreciate the aspects and limits of the use of ground level exposure. This GM shows the derivation of the term from the ICAO definition of the 'en-route phase' and then gives practical examples of the use, and limitations on the use, of ground level exposure in CAT.POL.400(c).
- (b) The take-off phase in performance class 1 and performance class 2 may be considered to be bounded by 'the specified point in the take-off' from which the take-off flight path begins.
 - (1) In performance class 1, this specified point is defined as 'the end of the take-off distance required'.
 - (2) In performance class 2, this specified point is defined as DPATO or, as an alternative, no later than 200 ft above the take-off surface.
 - (3) There is no simple equivalent point for bounding of the landing in performance classes 1 & 2.
- (c) Take-off flight path is not used in performance class 3 and, consequently, the term 'take-off and landing phases' is used to bound the limit of exposure. For the purpose of performance class 3, the take-off and landing phases are as set out in CAT.POL.H.400(c) and are considered to be bounded by:

- (1) during take-off before reaching V_y (speed for best rate of climb) or 200 ft above the take-off surface; and
- (2) during landing, below 200 ft above the landing surface.

(ICAO Annex 6 Part III, defines en-route phase as being “That part of the flight from the end of the take-off and initial climb phase to the commencement of the approach and landing phase.” The use of take-off and landing phase in this text is used to distinguish the take-off from the initial climb, and the landing from the approach: they are considered to be complimentary and not contradictory.)

- (d) Ground level exposure — and exposure for elevated FATOs or helidecks in a non-hostile environment — is permitted for operations under an approval in accordance with CAT.POL.H.305. Exposure in this case is limited to the ‘take-off and landing phases’.

The practical effect of bounding of exposure can be illustrated with the following examples:

- (1) A clearing: the operator may consider a take-off/landing in a clearing when there is sufficient power, with all engines operating, to clear all obstacles in the take-off path by an adequate margin (this, in ICAO, is meant to indicate 35 ft). Thus, the clearing may be bounded by bushes, fences, wires and, in the extreme, by power lines, high trees, etc. Once the obstacle has been cleared, by using a steep or a vertical climb (which itself may infringe the height velocity (HV) diagram), the helicopter reaches V_y or 200 ft, and from that point a safe forced landing must be possible. The effect is that whilst operation to a clearing is possible, operation to a clearing in the middle of a forest is not (except when operated in accordance with CAT.POL.H.420).
 - (2) An aerodrome/operating site surrounded by rocks: the same applies when operating to a landing site that is surrounded by rocky ground. Once V_y or 200 ft has been reached, a safe forced landing must be possible.
 - (3) An elevated FATO or helideck: when operating to an elevated FATO or helideck in performance class 3, exposure is considered to be twofold: firstly, to a deck-edge strike if the engine fails after the decision to transition has been taken; and secondly, to operations in the HV diagram due to the height of the FATO or helideck. Once the take-off surface has been cleared and the helicopter has reached the knee of the HV diagram, the helicopter should be capable of making a safe forced landing.
- (e) Operation in accordance with CAT.POL.400(b) does not permit excursions into a hostile environment as such and is specifically concerned with the absence of space to abort the take-off or landing when the take-off and landing space are limited; or when operating in the HV diagram.
 - (f) Specifically, the use of this exception to the requirement for a safe forced landing (during take-off or landing) does not permit semi-continuous operations over a hostile environment such as a forest or hostile sea area.

CAT.POL.H.405 Take-off

- (a) The take-off mass shall be the lower of:
 - (1) the MCTOM; or
 - (2) the maximum take-off mass specified for a hover in ground effect with all engines operating at take-off power, or if conditions are such that a hover in ground effect is not likely to be established, the take-off mass specified for a hover out of ground effect with all engines operating at take-off power.
- (b) Except as provided in CAT.POL.H.400(b), in the event of an engine failure the helicopter shall be able to perform a safe forced landing.

CAT.POL.H.410 En-route

- (a) The helicopter shall be able, with all engines operating within the maximum continuous power conditions, to continue along its intended route or to a planned diversion without flying at any point below the appropriate minimum flight altitude.
- (b) Except as provided in CAT.POL.H.420, in the event of an engine failure the helicopter shall be able to perform a safe forced landing.

CAT.POL.H.415 Landing

- (a) The landing mass of the helicopter at the estimated time of landing shall be the lower of:
 - (1) the maximum certified landing mass; or
 - (2) the maximum landing mass specified for a hover in ground effect, with all engines operating at take-off power, or if conditions are such that a hover in ground effect is not likely to be established, the landing mass for a hover out of ground effect with all engines operating at take-off power.
- (b) Except as provided in CAT.POL.H.400(b), in the event of an engine failure, the helicopter shall be able to perform a safe forced landing.

CAT.POL.H.420 Helicopter operations over a hostile environment located outside a congested area

- (a) Operations over a non-congested hostile environment without a safe forced landing capability with turbine-powered helicopters with an MOPSC of six or less shall only be conducted if the operator has been granted an approval by the competent authority, following a safety risk assessment performed by the operator. Before such operations take place in another Member State, the operator shall obtain an endorsement from the competent authority of that State.
- (b) To obtain and maintain such approval the operator shall:
 - (1) only conduct these operations in the areas and under the conditions specified in the approval;
 - (2) not conduct these operations under a HEMS approval;
 - (3) substantiate that helicopter limitations, or other justifiable considerations, preclude the use of the appropriate performance criteria; and
 - (4) be approved in accordance with CAT.POL.H.305(b).

- (c) Notwithstanding CAT.IDE.H.240, such operations may be conducted without supplemental oxygen equipment, provided the cabin altitude does not exceed 10 000 ft for a period in excess of 30 minutes and never exceeds 13 000 ft pressure altitude.

AMC1 CAT.POL.H.420 Helicopter operations over a hostile environment located outside a congested area

SAFETY RISK ASSESSMENT

(a) Introduction

Two cases that are deemed to be acceptable for the alleviation under the conditions of CAT.POL.H.420 for the en-route phase of the flight (operations without an assured safe forced landing capability during take-off and landing phases are subject to a separate approval under CAT.POL.H.400(c)) are flights over mountainous areas and remote areas, both already having been considered by the JAA in comparison to ground transport in the case of remote areas and respectively to multi-engined helicopters in the case of mountain areas.

(1) Remote areas

Remote area operation is acceptable when alternative surface transportation does not provide the same level of safety as helicopter transportation. In this case, the operator should demonstrate why the economic circumstances do not justify replacement of single-engined helicopters by multi-engined helicopters.

(2) Mountainous areas

Current generation twin-engined helicopters may not be able to meet the performance class 1 or 2 requirements at the operational altitude; consequently, the outcome of an engine failure is the same as a single-engined helicopter. In this case, the operator should justify the use of exposure in the en-route phase.

(b) Other areas of operation

For other areas of operations to be considered for the operational approval, a risk assessment should be conducted by the operator that should, at least, consider the following factors:

- (1) type of operations and the circumstances of the flight;
- (2) area/terrain over which the flight is being conducted;
- (3) probability of an engine failure and the consequence of such an event;
- (4) safety target;
- (5) procedures to maintain the reliability of the engine(s);
- (6) installation and utilisation of a usage monitoring system; and
- (7) when considered relevant, any available publications on (analysis of) accident or other safety data.

GM1 CAT.POL.H.420 Helicopter operations over a hostile environment located outside a congested area

EXAMPLE OF A SAFETY RISK ASSESSMENT

(a) Introduction

Where it can be substantiated that helicopter limitations, or other justifiable considerations, preclude the use of appropriate performance, the approval effectively alleviates from compliance with the requirement in CAT.OP.MPA.137, that requires the availability of surfaces that permit a safe forced landing to be executed.

Circumstances where an engine failure will result in a catastrophic event are those defined for a hostile environment:

- (1) a lack of adequate surfaces to perform a safe landing;
- (2) the inability to protect the occupants of the helicopter from the elements; or
- (3) a lack of search and rescue services to provide rescue consistent with the expected survival time in such environment.

(b) The elements of the risk assessment

The risk assessment process consists of the application of three principles:

- a safety target;
- a helicopter reliability assessment; and
- continuing airworthiness.

(1) The safety target

The main element of the risk assessment when exposure was initially introduced by the JAA into JAR-OPS 3 (NPA OPS-8), was the assumption that turbine engines in helicopters would have failure rates of about 1:100 000 per flying hour — which would permit (against the agreed safety target of 5×10^{-8} per event) an exposure of about 9 seconds for twin-engined helicopters and 18 seconds for single-engined helicopters during the take-off or landing event.

An engine failure in the en-route phase over a hostile environment will inevitably result in a higher risk (in the order of magnitude of 1×10^{-5} per flying hour) to a catastrophic event.

The approval to operate with this high risk of endangering the helicopter occupants should, therefore, only be granted against a comparative risk assessment (i.e. compared to other means of transport, the risk is demonstrated to be lower), or where there is no economic justification to replace single-engined helicopters by multi-engined helicopters.

(2) The reliability assessment

The purpose of the reliability assessment is to ensure that the engine reliability remains at or better than 1×10^{-5} .

(3) Continuing airworthiness

Mitigating procedures consist of a number of elements:

- (i) the fulfilment of all manufacturers' safety modifications;
- (ii) a comprehensive reporting system (both failures and usage data); and
- (iii) the implementation of a usage monitoring system (UMS).

Each of these elements is to ensure that engines, once shown to be sufficiently reliable to meet the safety target, will sustain such reliability (or improve upon it).

The monitoring system is felt to be particularly important as it had already been demonstrated that when such systems are in place, it inculcates a more considered

approach to operations. In addition, the elimination of 'hot starts', prevented by the UMS, itself minimises the incidents of turbine burst failures.

GM2 CAT.POL.H.420(a) Helicopter operations over a hostile environment located outside a congested area

ENDORSEMENT FROM ANOTHER STATE

(a) Application to another State

To obtain an endorsement from another State, the operator should submit to that State the safety risk assessment and the reasons and justification that preclude the use of appropriate performance criteria, over those hostile areas outside a congested area over which the operator is planning to conduct operations.

(b) Endorsement from another State

Upon receiving the endorsement from another State, the operator should submit it together with the safety risk assessment and the reasons and justification that preclude the use of appropriate performance criteria, to the competent authority issuing the AOC to obtain the approval or extend the existing approval to a new area.

SECTION 3
Mass and balance

CHAPTER 1
Motor-powered aircraft

CAT.POL.MAB.100 Mass and balance, loading

- (a) During any phase of operation, the loading, mass and centre of gravity (CG) of the aircraft shall comply with the limitations specified in the AFM, or the operations manual if more restrictive.
- (b) The operator shall establish the mass and the CG of any aircraft by actual weighing prior to initial entry into service and thereafter at intervals of four years if individual aircraft masses are used, or nine years if fleet masses are used. The accumulated effects of modifications and repairs on the mass and balance shall be accounted for and properly documented. Aircraft shall be reweighed if the effect of modifications on the mass and balance is not accurately known.
- (c) The weighing shall be accomplished by the manufacturer of the aircraft or by an approved maintenance organisation.
- (d) The operator shall determine the mass of all operating items and crew members included in the aircraft dry operating mass by weighing or by using standard masses. The influence of their position on the aircraft's CG shall be determined.
- (e) The operator shall establish the mass of the traffic load, including any ballast, by actual weighing or by determining the mass of the traffic load in accordance with standard passenger and baggage masses.
- (f) In addition to standard masses for passengers and checked baggage, the operator can use standard masses for other load items, if it demonstrates to the competent authority that these items have the same mass or that their masses are within specified tolerances.
- (g) The operator shall determine the mass of the fuel load by using the actual density or, if not known, the density calculated in accordance with a method specified in the operations manual.
- (h) The operator shall ensure that the loading of:
 - (1) its aircraft is performed under the supervision of qualified personnel; and
 - (2) traffic load is consistent with the data used for the calculation of the aircraft mass and balance.
- (i) The operator shall comply with additional structural limits such as the floor strength limitations, the maximum load per running metre, the maximum mass per cargo compartment and the maximum seating limit. For helicopters, in addition, the operator shall take account of in-flight changes in loading.
- (j) The operator shall specify, in the operations manual, the principles and methods involved in the loading and in the mass and balance system that meet the requirements contained in (a) to (i). This system shall cover all types of intended operations.

AMC1 CAT.POL.MAB.100(a) Mass and balance, loading**CENTRE OF GRAVITY LIMITS — OPERATIONAL CG ENVELOPE AND IN-FLIGHT CG**

In the Certificate Limitations section of the AFM, forward and aft CG limits are specified. These limits ensure that the certification stability and control criteria are met throughout the whole flight and allow the proper trim setting for take-off. The operator should ensure that these limits are respected by:

- (a) Defining and applying operational margins to the certified CG envelope in order to compensate for the following deviations and errors:
 - (1) Deviations of actual CG at empty or operating mass from published values due, for example, to weighing errors, unaccounted modifications and/or equipment variations.
 - (2) Deviations in fuel distribution in tanks from the applicable schedule.
 - (3) Deviations in the distribution of baggage and cargo in the various compartments as compared with the assumed load distribution as well as inaccuracies in the actual mass of baggage and cargo.
 - (4) Deviations in actual passenger seating from the seating distribution assumed when preparing the mass and balance documentation. Large CG errors may occur when ‘free seating’, i.e. freedom of passengers to select any seat when entering the aircraft, is permitted. Although in most cases reasonably even longitudinal passenger seating can be expected, there is a risk of an extreme forward or aft seat selection causing very large and unacceptable CG errors, assuming that the balance calculation is done on the basis of an assumed even distribution. The largest errors may occur at a load factor of approximately 50% if all passengers are seated in either the forward or aft half of the cabin. Statistical analysis indicates that the risk of such extreme seating adversely affecting the CG is greatest on small aircraft.
 - (5) Deviations of the actual CG of cargo and passenger load within individual cargo compartments or cabin sections from the normally assumed mid position.
 - (6) Deviations of the CG caused by gear and flap positions and by application of the prescribed fuel usage procedure, unless already covered by the certified limits.
 - (7) Deviations caused by in-flight movement of cabin crew, galley equipment and passengers.
 - (8) On small aeroplanes, deviations caused by the difference between actual passenger masses and standard passenger masses when such masses are used.
- (b) Defining and applying operational procedures in order to:
 - (1) ensure an even distribution of passengers in the cabin;
 - (2) take into account any significant CG travel during flight caused by passenger/crew movement; and
 - (3) take into account any significant CG travel during flight caused by fuel consumption/transfer.

AMC1 CAT.POL.MAB.100(b) Mass and balance, loading**WEIGHING OF AN AIRCRAFT**

- (a) New aircraft that have been weighed at the factory may be placed into operation without reweighing if the mass and balance records have been adjusted for alterations or modifications to the aircraft. Aircraft transferred from one EU operator to another EU operator do not have to be

weighed prior to use by the receiving operator unless more than 4 years have elapsed since the last weighing.

- (b) The mass and centre of gravity (CG) position of an aircraft should be revised whenever the cumulative changes to the dry operating mass exceed $\pm 0.5\%$ of the maximum landing mass or, for aeroplanes, the cumulative change in CG position exceeds 0.5% of the mean aerodynamic chord. This may be done by weighing the aircraft or by calculation. If the AFM requires to record changes to mass and CG position below these thresholds, or to record changes in any case, and make them known to the commander, mass and CG position should be revised accordingly and made known to the commander.
- (c) When weighing an aircraft, normal precautions should be taken consistent with good practices such as:
- (1) checking for completeness of the aircraft and equipment;
 - (2) determining that fluids are properly accounted for;
 - (3) ensuring that the aircraft is clean; and
 - (4) ensuring that weighing is accomplished in an enclosed building.
- (d) Any equipment used for weighing should be properly calibrated, zeroed, and used in accordance with the manufacturer's instructions. Each scale should be calibrated either by the manufacturer, by a civil department of weights and measures or by an appropriately authorised organisation within two years or within a time period defined by the manufacturer of the weighing equipment, whichever is less. The equipment should enable the mass of the aircraft to be established accurately. One single accuracy criterion for weighing equipment cannot be given. However, the weighing accuracy is considered satisfactory if the accuracy criteria in Table 1 are met by the individual scales/cells of the weighing equipment used:

Table 1

Accuracy criteria for weighing equipment

For a scale/cell load	An accuracy of
below 2 000 kg	$\pm 1\%$
from 2 000 kg to 20 000 kg	± 20 kg
above 20 000 kg	$\pm 0.1\%$

AMC2 CAT.POL.MAB.100(b) Mass and balance, loading

FLEET MASS AND CG POSITION — AEROPLANES

- (a) For a group of aeroplanes of the same model and configuration, an average dry operating mass and CG position may be used as the fleet mass and CG position, provided that:
- (1) the dry operating mass of an individual aeroplane does not differ by more than $\pm 0.5\%$ of the maximum structural landing mass from the established dry operating fleet mass; or
 - (2) the CG position of an individual aeroplane does not differ by more than $\pm 0.5\%$ of the mean aerodynamic chord from the established fleet CG.
- (b) The operator should verify that, after an equipment or configuration change or after weighing, the aeroplane falls within the tolerances above.

- (c) To add an aeroplane to a fleet operated with fleet values, the operator should verify by weighing or calculation that its actual values fall within the tolerances specified in (a)(1) and (2).
- (d) To obtain fleet values, the operator should weigh, in the period between two fleet mass evaluations, a certain number of aeroplanes as specified in Table 1, where 'n' is the number of aeroplanes in the fleet using fleet values. Those aeroplanes in the fleet that have not been weighed for the longest time should be selected first.

Table 1

Minimum number of weighings to obtain fleet values

Number of aeroplanes in the fleet	Minimum number of weighings
2 or 3	n
4 to 9	$(n + 3)/2$
10 or more	$(n + 51)/10$

- (e) The interval between two fleet mass evaluations should not exceed 48 months.
- (f) The fleet values should be updated at least at the end of each fleet mass evaluation.
- (g) Aeroplanes that have not been weighed since the last fleet mass evaluation may be kept in a fleet operated with fleet values, provided that the individual values are revised by calculation and stay within the tolerances above. If these individual values no longer fall within the tolerances, the operator should determine new fleet values or operate aeroplanes not falling within the limits with their individual values.
- (h) If an individual aeroplane mass is within the dry operating fleet mass tolerance but its CG position exceeds the tolerance, the aeroplane may be operated under the applicable dry operating fleet mass but with an individual CG position.
- (i) Aeroplanes for which no mean aerodynamic chord has been published, should be operated with their individual mass and CG position values. They may be operated under the dry operating fleet mass and CG position, provided that a risk assessment has been completed.

AMC1 CAT.POL.MAB.100(d) Mass and balance, loading

DRY OPERATING MASS

The dry operating mass includes:

- (a) crew and crew baggage;
- (b) catering and removable passenger service equipment; and
- (c) tank water and lavatory chemicals.

AMC2 CAT.POL.MAB.100(d) Mass and balance, loading

MASS VALUES FOR CREW MEMBERS

- (a) The operator should use the following mass values for crew to determine the dry operating mass:
- (1) actual masses including any crew baggage; or

- (2) standard masses, including hand baggage, of 85 kg for flight crew/technical crew members and 75 kg for cabin crew members.
- (b) The operator should correct the dry operating mass to account for any additional baggage. The position of this additional baggage should be accounted for when establishing the centre of gravity of the aeroplane.

AMC1 CAT.POL.MAB.100(e) Mass and balance, loading

MASS VALUES FOR PASSENGERS AND BAGGAGE

- (a) When the number of passenger seats available is:
 - (1) less than 10 for aeroplanes; or
 - (2) less than 6 for helicopters,passenger mass may be calculated on the basis of a statement by, or on behalf of, each passenger, adding to it a predetermined mass to account for hand baggage and clothing.
The predetermined mass for hand baggage and clothing should be established by the operator on the basis of studies relevant to his particular operation. In any case, it should not be less than:
 - (1) 4 kg for clothing; and
 - (2) 6 kg for hand baggage.The passengers' stated mass and the mass of passengers' clothing and hand baggage should be checked prior to boarding and adjusted, if necessary. The operator should establish a procedure in the operations manual when to select actual or standard masses and the procedure to be followed when using verbal statements.
- (b) When determining the actual mass by weighing, passengers' personal belongings and hand baggage should be included. Such weighing should be conducted immediately prior to boarding the aircraft.
- (c) When determining the mass of passengers by using standard mass values, the standard mass values in Tables 1 and 2 below should be used. The standard masses include hand baggage and the mass of any infant carried by an adult on one passenger seat. Infants occupying separate passenger seats should be considered as children for the purpose of this AMC. When the total number of passenger seats available on an aircraft is 20 or more, the standard masses for males and females in Table 1 should be used. As an alternative, in cases where the total number of passenger seats available is 30 or more, the 'All Adult' mass values in Table 1 may be used.

Table 1

Standard masses for passengers — aircraft with a total number of passenger seats of 20 or more

Passenger seats:	20 and more		30 and more
	Male	Female	All adult
All flights except holiday charters	88 kg	70 kg	84 kg
Holiday charters(*)	83 kg	69 kg	76 kg
Children	35 kg	35 kg	35 kg

- (*) Holiday charter means a charter flight that is part of a holiday travel package. On such flights the entire passenger capacity is hired by one or more charterer(s) for the carriage of passengers who are travelling, all or in part by air, on a round- or circle-trip basis for holiday purposes. The holiday charter mass values apply provided that not more than 5 % of passenger seats installed in the aircraft are used for the non-revenue carriage of certain categories of passengers. Categories of passengers such as company personnel, tour operators' staff, representatives of the press, authority officials, etc. can be included within the 5% without negating the use of holiday charter mass values.

Table 2

Standard masses for passengers — aircraft with a total number of passenger seats of 19 or less

Passenger seats:	1 - 5	6 - 9	10 - 19
Male	104 kg	96 kg	92 kg
Female	86 kg	78 kg	74 kg
Children	35 kg	35 kg	35 kg

- (1) On aeroplane flights with 19 passenger seats or less and all helicopter flights where no hand baggage is carried in the cabin or where hand baggage is accounted for separately, 6 kg may be deducted from male and female masses in Table 2. Articles such as an overcoat, an umbrella, a small handbag or purse, reading material or a small camera are not considered as hand baggage.
- (2) For helicopter operations in which a survival suit is provided to passengers, 3 kg should be added to the passenger mass value.
- (d) Mass values for baggage
- (1) Aeroplanes. When the total number of passenger seats available on the aeroplane is 20 or more, the standard mass values for checked baggage of Table 3 should be used.
- (2) Helicopters. When the total number of passenger seats available on the helicopters is 20 or more, the standard mass value for checked baggage should be 13 kg.
- (3) For aircraft with 19 passenger seats or less, the actual mass of checked baggage should be determined by weighing.

Table 3

Standard masses for baggage — aeroplanes with a total number of passenger seats of 20 or more

Type of flight	Baggage standard mass
Domestic	11 kg
Within the European region	13 kg
Intercontinental	15 kg
All other	13 kg

- (4) For the purpose of Table 3:
- (i) domestic flight means a flight with origin and destination within the borders of one State;
 - (ii) flights within the European region mean flights, other than domestic flights, whose origin and destination are within the area specified in (d)(5); and
 - (iii) intercontinental flight means flights beyond the European region with origin and destination in different continents.
- (5) Flights within the European region are flights conducted within the following area:
- N7200 E04500
 - N4000 E04500
 - N3500 E03700
 - N3000 E03700
 - N3000 W00600
 - N2700 W00900
 - N2700 W03000
 - N6700 W03000
 - N7200 W01000
 - N7200 E04500

as depicted in Figure 1.

Figure 1

The European region



- (f) Other standard masses may be used provided they are calculated on the basis of a detailed weighing survey plan and a reliable statistical analysis method is applied. The operator should advise the competent authority about the intent of the passenger weighing survey and explain the survey plan in general terms. The revised standard mass values should only be used in circumstances comparable with those under which the survey was conducted. Where the revised standard masses exceed those in Tables 1, 2 and 3 of, then such higher values should be used.
- (g) On any flight identified as carrying a significant number of passengers whose masses, including hand baggage, are expected to significantly deviate from the standard passenger mass, the operator should determine the actual mass of such passengers by weighing or by adding an adequate mass increment.
- (h) If standard mass values for checked baggage are used and a significant number of passengers checked baggage is expected to significantly deviate from the standard baggage mass, the operator should determine the actual mass of such baggage by weighing or by adding an adequate mass increment.

AMC2 CAT.POL.MAB.100(e) Mass and balance, loading**PROCEDURE FOR ESTABLISHING REVISED STANDARD MASS VALUES FOR PASSENGERS AND BAGGAGE**

- (a) Passengers
 - (1) Weight sampling method. The average mass of passengers and their hand baggage should be determined by weighing, taking random samples. The selection of random samples should by nature and extent be representative of the passenger volume, considering the type of operation, the frequency of flights on various routes, in/outbound flights, applicable season and seat capacity of the aircraft.
 - (2) Sample size. The survey plan should cover the weighing of at least the greatest of:
 - (i) a number of passengers calculated from a pilot sample, using normal statistical procedures and based on a relative confidence range (accuracy) of 1 % for all adult and 2 % for separate male and female average masses; and

- (ii) for aircraft:
 - (A) with a passenger seating capacity of 40 or more, a total of 2 000 passengers; or
 - (B) with a passenger seating capacity of less than 40, a total number of 50 multiplied by the passenger seating capacity.
- (3) Passenger masses. Passenger masses should include the mass of the passengers' belongings that are carried when entering the aircraft. When taking random samples of passenger masses, infants should be weighted together with the accompanying adult.
- (4) Weighing location. The location for the weighing of passengers should be selected as close as possible to the aircraft, at a point where a change in the passenger mass by disposing of or by acquiring more personal belongings is unlikely to occur before the passengers board the aircraft.
- (5) Weighing machine. The weighing machine used for passenger weighing should have a capacity of at least 150 kg. The mass should be displayed at minimum graduations of 500 g. The weighing machine should have an accuracy of at least 0.5 % or 200 g, whichever is greater.
- (6) Recording of mass values. For each flight included in the survey the mass of the passengers, the corresponding passenger category (i.e. male/female/children) and the flight number should be recorded.
- (b) Checked baggage. The statistical procedure for determining revised standard baggage mass values based on average baggage masses of the minimum required sample size should comply with (a)(1) and (a)(2). For baggage, the relative confidence range (accuracy) should amount to 1 %. A minimum of 2 000 pieces of checked baggage should be weighed.
- (c) Determination of revised standard mass values for passengers and checked baggage
 - (1) To ensure that, in preference to the use of actual masses determined by weighing, the use of revised standard mass values for passengers and checked baggage does not adversely affect operational safety, a statistical analysis should be carried out. Such an analysis should generate average mass values for passengers and baggage as well as other data.
 - (2) On aircraft with 20 or more passenger seats, these averages apply as revised standard male and female mass values.
 - (3) On aircraft with 19 passenger seats or less, the increments in Table 1 should be added to the average passenger mass to obtain the revised standard mass values.

Table 1

Increments for revised standard masses values

Number of passenger seats	Required mass increment
1 – 5 incl.	16 kg
6 – 9 incl.	8 kg
10 – 19 incl.	4 kg

Alternatively, all adult revised standard (average) mass values may be applied on aircraft with 30 or more passenger seats. Revised standard (average) checked baggage mass values are applicable to aircraft with 20 or more passenger seats.

- (4) The revised standard masses should be reviewed at intervals not exceeding 5 years.
- (5) All adult revised standard mass values should be based on a male/female ratio of 80/20 in respect of all flights except holiday charters that are 50/50. A different ratio on specific routes or flights may be used, provided supporting data shows that the alternative male/female ratio is conservative and covers at least 84 % of the actual male/female ratios on a sample of at least 100 representative flights.
- (6) The resulting average mass values should be rounded to the nearest whole number in kg. Checked baggage mass values should be rounded to the nearest 0.5 kg figure, as appropriate.
- (7) When operating on similar routes or networks, operators may pool their weighing surveys provided that in addition to the joint weighing survey results, results from individual operators participating in the joint survey are separately indicated in order to validate the joint survey results.

GM1 CAT.POL.MAB.100(e) Mass and balance, loading

ADJUSTMENT OF STANDARD MASSES

When standard mass values are used, AMC1 CAT.POL.MAB.100(e) subparagraph (g) states that the operator should identify and adjust the passenger and checked baggage masses in cases where significant numbers of passengers or quantities of baggage are suspected of significantly deviating from the standard values. Therefore, the operations manual should contain instructions to ensure that:

- (a) check-in, operations and cabin staff and loading personnel report or take appropriate action when a flight is identified as carrying a significant number of passengers whose masses, including hand baggage, are expected to significantly deviate from the standard passenger mass, and/or groups of passengers carrying exceptionally heavy baggage (e.g. military personnel or sports teams); and
- (b) on small aircraft, where the risks of overload and/or CG errors are the greatest, pilots pay special attention to the load and its distribution and make proper adjustments.

GM2 CAT.POL.MAB.100(e) Mass and Balance, Loading

STATISTICAL EVALUATION OF PASSENGERS AND BAGGAGE DATA

- (a) Sample size
 - (1) For calculating the required sample size, it is necessary to make an estimate of the standard deviation on the basis of standard deviations calculated for similar populations or for preliminary surveys. The precision of a sample estimate is calculated for 95 % reliability or 'significance', i.e. there is a 95 % probability that the true value falls within the specified confidence interval around the estimated value. This standard deviation value is also used for calculating the standard passenger mass.
 - (2) As a consequence, for the parameters of mass distribution, i.e. mean and standard deviation, three cases have to be distinguished:
 - (i) μ, σ = the true values of the average passenger mass and standard deviation, which are unknown and which are to be estimated by weighing passenger samples.
 - (ii) μ', σ' = the 'a priori' estimates of the average passenger mass and the standard deviation, i.e. values resulting from an earlier survey, which are needed to determine the current sample size.

- (iii) \bar{x} , s = the estimates for the current true values of m and s , calculated from the sample.

The sample size can then be calculated using the following formula:

$$n \geq \frac{(1.96 * \sigma' * 100)^2}{(e_r' * \mu')^2}$$

where:

n = number of passengers to be weighed (sample size)

e_r' = allowed relative confidence range (accuracy) for the estimate of μ by \bar{x} (see also equation in (c)). The allowed relative confidence range specifies the accuracy to be achieved when estimating the true mean. For example, if it is proposed to estimate the true mean to within $\pm 1\%$, then e_r' will be 1 in the above formula.

1.96 = value from the Gaussian distribution for 95 % significance level of the resulting confidence interval.

- (b) Calculation of average mass and standard deviation. If the sample of passengers weighed is drawn at random, then the arithmetic mean of the sample (\bar{x}) is an unbiased estimate of the true average mass (μ) of the population.
- (1) Arithmetic mean of sample where:

$$\bar{x} = \frac{\sum_{j=1}^n x_j}{n}$$

x_j = mass values of individual passengers (sampling units).

- (2) Standard deviation where:

$$S = \sqrt{\frac{\sum_{j=1}^n (x_j - \bar{x})^2}{n - 1}}$$

$x_j - \bar{x}$ = deviation of the individual value from the sample mean.

- (c) Checking the accuracy of the sample mean. The accuracy (confidence range) which can be ascribed to the sample mean as an indicator of the true mean is a function of the standard deviation of the sample which has to be checked after the sample has been evaluated. This is done using the formula:

$$e_r = \frac{1.96 * S * 100}{\sqrt{n} * \bar{x}} (\%)$$

whereby e_r should not exceed 1 % for an all adult average mass and 2 % for an average male and/or female mass. The result of this calculation gives the relative accuracy of the estimate of μ at the 95 % significance level. This means that with 95 % probability, the true average mass μ lies within the interval:

$$\bar{x} \pm \frac{1.96 * S}{\sqrt{n}}$$

- (d) Example of determination of the required sample size and average passenger mass

- (1) Introduction. Standard passenger mass values for mass and balance purposes require passenger weighing programs to be carried out. The following example shows the various steps required for establishing the sample size and evaluating the sample data. It is provided primarily for those who are not well versed in statistical computations. All mass figures used throughout the example are entirely fictitious.

- (2) Determination of required sample size. For calculating the required sample size, estimates of the standard (average) passenger mass and the standard deviation are needed. The ‘a priori’ estimates from an earlier survey may be used for this purpose. If such estimates are not available, a small representative sample of about 100 passengers should be weighed so that the required values can be calculated. The latter has been assumed for the example.

Step 1: Estimated average passenger mass.

n	x _j (kg)
1	79.9
2	68.1
3	77.9
4	74.5
5	54.1
6	62.2
7	89.3
8	108.7
.	.
85	63.2
86	75.4
$\sum_{j=1}^{86}$	6 071.6

$$\mu' = \bar{x} = \frac{\sum x_j}{n} = \frac{6071.6}{86} = 70.6 \text{ kg}$$

Step 2: Estimated standard deviation.

n	x _j	(x _j – \bar{x})	(x _j – \bar{x}) ²
1	79.9	+9.3	86.49
2	68.1	–2.5	6.25
3	77.9	+7.3	53.29

4	74.5	+3.9	15.21
5	54.1	-16.5	272.25
6	62.2	-8.4	70.56
7	89.3	+18.7	349.69
8	108.7	+38.1	1 451.61
.	.	.	.
85	63.2	-7.4	54.76
86	75.4	-4.8	23.04
$\sum_{j=1}^{86}$	6 071.6		34 683.40

$$\sigma' = \sqrt{\frac{\sum (x_j - \bar{x})^2}{n - 1}}$$

$$\sigma' = \sqrt{\frac{34\,683.40}{86 - 1}}$$

$$\sigma' = 20.20 \text{ kg}$$

Step 3: Required sample size.

The required number of passengers to be weighed should be such that the confidence range, e'_r does not exceed 1 %, as specified in (c).

$$n \geq \frac{(1.96 * \sigma' * 100)^2}{(e'_r * \mu')^2}$$

$$n \geq \frac{(1.96 * 20.20 * 100)^2}{(1 * 70.6)^2}$$

$$n \geq 3145$$

The result shows that at least 3 145 passengers should be weighed to achieve the required accuracy. If e'_r is chosen as 2 % the result would be $n \geq 786$.

Step 4: After having established the required sample size, a plan for weighing the passengers is to be worked out.

(3) Determination of the passenger average mass

Step 1: Having collected the required number of passenger mass values, the average passenger mass can be calculated. For the purpose of this example, it has been assumed that 3 180 passengers were weighed. The sum of the individual masses amounts to 231 186.2 kg.

$$n = 3\,180$$

$$\sum_{j=1}^{3180} X_j = 231\,186.2 \text{ kg}$$

$$\bar{x} = \frac{\sum x_j}{n} = \frac{231\,186.2}{3\,180} \text{ kg}$$

$$\bar{x} = 72.7 \text{ kg}$$

Step 2: Calculation of the standard deviation

For calculating the standard deviation, the method shown in paragraph (2) step 2 should be applied.

$$\sum (x_j - \bar{x})^2 = 745\,145.20$$

$$s = \sqrt{\frac{\sum (x_j - \bar{x})^2}{n - 1}}$$

$$s = \sqrt{\frac{745\,145.20}{3\,180 - 1}}$$

$$s = 15.31 \text{ kg}$$

Step 3: Calculation of the accuracy of the sample mean

$$e_r = \frac{1.96 * s * 100}{\sqrt{n} * \bar{x}} \%$$

$$e_r = \frac{1.96 * 15.31 * 100}{\sqrt{3\,180} * 72.7} \%$$

$$e_r = 0.73 \%$$

Step 4: Calculation of the confidence range of the sample mean

$$\bar{x} \pm \frac{1.96 * s}{\sqrt{n}}$$

$$\bar{x} \pm \frac{1.96 * 15.31}{\sqrt{3180}} \text{ kg}$$

$$72.7 \pm 0.5 \text{ kg}$$

The result of this calculation shows that there is a 95 % probability of the actual mean for all passengers lying within the range 72.2 kg to 73.2 kg.

GM3 CAT.POL.MAB.100(e) Mass and balance, loading

GUIDANCE ON PASSENGER WEIGHING SURVEYS

(a) Detailed survey plan

- (1) The operator should establish and submit to the competent authority a detailed weighing survey plan that is fully representative of the operation, i.e. the network or route under consideration and the survey should involve the weighing of an adequate number of passengers.
- (2) A representative survey plan means a weighing plan specified in terms of weighing locations, dates and flight numbers giving a reasonable reflection of the operator's timetable and/or area of operation.
- (3) The minimum number of passengers to be weighed is the highest of the following:
 - (i) The number that follows from the means of compliance that the sample should be representative of the total operation to which the results will be applied; this will often prove to be the overriding requirement.
 - (ii) The number that follows from the statistical requirement specifying the accuracy of the resulting mean values, which should be at least 2 % for male and female standard masses and 1 % for all adult standard masses, where applicable. The required sample size can be estimated on the basis of a pilot sample (at least 100 passengers) or from a previous survey. If analysis of the results of the survey indicates that the requirements on the accuracy of the mean values for male or female standard masses or all adult standard masses, as applicable, are not met, an additional number of representative passengers should be weighed in order to satisfy the statistical requirements.
- (4) To avoid unrealistically small samples, a minimum sample size of 2 000 passengers (males + females) is also required, except for small aircraft where in view of the burden of the large number of flights to be weighed to cover 2 000 passengers, a lesser number is considered acceptable.

(b) Execution of weighing programme

- (1) At the beginning of the weighing programme, it is important to note, and to account for, the data requirements of the weighing survey report (see (e)).
- (2) As far as is practicable, the weighing programme should be conducted in accordance with the specified survey plan.

-
- (3) Passengers and all their personal belongings should be weighed as close as possible to the boarding point and the mass, as well as the associated passenger category (male/female/child), should be recorded.
- (c) Analysis of results of weighing survey. The data of the weighing survey should be analysed as explained in this GM. To obtain an insight to variations per flight, per route, etc. this analysis should be carried out in several stages, i.e. by flight, by route, by area, inbound/outbound, etc. Significant deviations from the weighing survey plan should be explained as well as their possible effect(s) on the results.
- (d) Results of the weighing survey
- (1) The results of the weighing survey should be summarised. Conclusions and any proposed deviations from published standard mass values should be justified. The results of a passenger weighing survey are average masses for passengers, including hand baggage, which may lead to proposals to adjust the standard mass values given in AMC1 CAT.POL.MAB.100(e) Tables 1 and 2. These averages, rounded to the nearest whole number may, in principle, be applied as standard mass values for males and females on aircraft with 20 or more passenger seats. Because of variations in actual passenger masses, the total passenger load also varies and statistical analysis indicates that the risk of a significant overload becomes unacceptable for aircraft with less than 20 seats. This is the reason for passenger mass increments on small aircraft.
 - (2) The average masses of males and females differ by some 15 kg or more. Because of uncertainties in the male/female ratio, the variation of the total passenger load is greater if all adult standard masses are used than when using separate male and female standard masses. Statistical analysis indicates that the use of all adult standard mass values should be limited to aircraft with 30 passenger seats or more.
 - (3) Standard mass values for all adults must be based on the averages for males and females found in the sample, taking into account a reference male/female ratio of 80/20 for all flights except holiday charters where a ratio of 50/50 applies. The operator may, based on the data from his weighing programme, or by proving a different male/female ratio, apply for approval of a different ratio on specific routes or flights.
- (e) Weighing survey report
- The weighing survey report, reflecting the content of (d)(1) - (3), should be prepared in a standard format as follows:

WEIGHING SURVEY REPORT**1 Introduction**

Objective and brief description of the weighing survey.

2 Weighing survey plan

Discussion of the selected flight number, airports, dates, etc.

Determination of the minimum number of passengers to be weighed.

Survey plan.

3 Analysis and discussion of weighing survey results

Significant deviations from survey plan (if any).

Variations in means and standard deviations in the network.

Discussion of the (summary of) results.

4 Summary of results and conclusions

Main results and conclusions.

Proposed deviations from published standard mass values.

Attachment 1

Applicable summer and/or winter timetables or flight programmes.

Attachment 2

Weighing results per flight (showing individual passenger masses and sex); means and standard deviations per flight, per route, per area and for the total network.

GM1 CAT.POL.MAB.100(g) Mass and balance, loading**FUEL DENSITY**

- (a) If the actual fuel density is not known, the operator may use standard fuel density values for determining the mass of the fuel load. Such standard values should be based on current fuel density measurements for the airports or areas concerned.
- (b) Typical fuel density values are:
- | | | | |
|-----|-------------------------------|---|------|
| (1) | Gasoline (piston engine fuel) | – | 0.71 |
| (2) | JET A1 (Jet fuel JP 1) | – | 0.79 |
| (3) | JET B (Jet fuel JP 4) | – | 0.76 |
| (4) | Oil | – | 0.88 |

GM1 CAT.POL.MAB.100(i) Mass and balance, loading

IN-FLIGHT CHANGES IN LOADING — HELICOPTERS

In-flight changes in loading may occur in hoist operations.

CAT.POL.MAB.105 Mass and balance data and documentation

- (a) The operator shall establish mass and balance data and produce mass and balance documentation prior to each flight specifying the load and its distribution. The mass and balance documentation shall enable the commander to determine that the load and its distribution is such that the mass and balance limits of the aircraft are not exceeded. The mass and balance documentation shall contain the following information:
- (1) Aircraft registration and type;
 - (2) Flight identification, number and date;
 - (3) Name of the commander;
 - (4) Name of the person who prepared the document;
 - (5) Dry operating mass and the corresponding CG of the aircraft:
 - (i) for performance class B aeroplanes and for helicopters the CG position may not need to be on the mass and balance documentation if, for example, the load distribution is in accordance with a pre-calculated balance table or if it can be shown that for the planned operations a correct balance can be ensured, whatever the real load is;
 - (6) Mass of the fuel at take-off and the mass of trip fuel;
 - (7) Mass of consumables other than fuel, if applicable;
 - (8) Load components including passengers, baggage, freight and ballast;
 - (9) Take-off mass, landing mass and zero fuel mass;
 - (10) Applicable aircraft CG positions; and
 - (11) The limiting mass and CG values.
- The information above shall be available in flight planning documents or mass and balance systems. Some of this information may be contained in other documents readily available for use.
- (b) Where mass and balance data and documentation is generated by a computerised mass and balance system, the operator shall verify the integrity of the output data.
- (c) The person supervising the loading of the aircraft shall confirm by hand signature or equivalent that the load and its distribution are in accordance with the mass and balance documentation given to the commander. The commander shall indicate his/her acceptance by hand signature or equivalent.
- (d) The operator shall specify procedures for last minute changes to the load to ensure that:
- (1) any last minute change after the completion of the mass and balance documentation is brought to the attention of the commander and entered in the flight planning documents containing the mass and balance documentation;
 - (2) the maximum last minute change allowed in passenger numbers or hold load is specified; and
 - (3) new mass and balance documentation is prepared if this maximum number is exceeded.
- (e) The operator shall obtain approval by the competent authority if he/she wishes to use an onboard integrated mass and balance computer system or a stand-alone computerised mass and balance system as a primary source for dispatch. The operator shall demonstrate the accuracy and reliability of that system.

AMC1 CAT.POL.MAB.105(a) Mass and balance data and documentation

CONTENTS

The mass and balance documentation should include advice to the commander whenever a non-standard method has been used for determining the mass of the load.

AMC1 CAT.POL.MAB.105(b) Mass and balance data and documentation

INTEGRITY

The operator should verify the integrity of mass and balance data and documentation generated by a computerised mass and balance system, at intervals not exceeding 6 months. The operator should establish a system to check that amendments of its input data are incorporated properly in the system and that the system is operating correctly on a continuous basis.

AMC1 CAT.POL.MAB.105(c) Mass and balance data and documentation

SIGNATURE OR EQUIVALENT

Where a signature by hand is impracticable or it is desirable to arrange the equivalent verification by electronic means, the following conditions should be applied in order to make an electronic signature the equivalent of a conventional hand-written signature:

- (a) electronic 'signing' by entering a personal identification number (PIN) code with appropriate security, etc.;
- (b) entering the PIN code generates a print-out of the individual's name and professional capacity on the relevant document(s) in such a way that it is evident, to anyone having a need for that information, who has signed the document;
- (c) the computer system logs information to indicate when and where each PIN code has been entered;
- (d) the use of the PIN code is, from a legal and responsibility point of view, considered to be fully equivalent to signature by hand;
- (e) the requirements for record keeping remain unchanged; and.
- (f) all personnel concerned are made aware of the conditions associated with electronic signature and this is documented.

AMC2 CAT.POL.MAB.105(c) Mass and balance data and documentation

MASS AND BALANCE DOCUMENTATION SENT VIA DATA LINK

Whenever the mass and balance documentation is sent to the aircraft via data link, a copy of the final mass and balance documentation, as accepted by the commander, should be available on the ground.

GM1 CAT.POL.MAB.105(e) Mass and balance data and documentation

ON-BOARD INTEGRATED MASS AND BALANCE COMPUTER SYSTEM.

An on-board integrated mass and balance computer system may be an aircraft installed system capable of receiving input data either from other aircraft systems or from a mass and balance system on ground, in order to generate mass and balance data as an output.

GM2 CAT.POL.MAB.105(e) Mass and balance data and documentation

STAND-ALONE COMPUTERISED MASS AND BALANCE SYSTEM

A stand-alone computerised mass and balance system may be a computer, either as a part of an electronic flight bag (EFB) system or solely dedicated to mass and balance purposes, requiring input from the user, in order to generate mass and balance data as an output.

SECTION 4
Sailplanes**CAT.POL.S.100 Operating limitations**

- (a) During any phase of operation, the loading, the mass and the centre of gravity (CG) position of the sailplane shall comply with any limitation specified in the AFM or the operations manual (OM) if more restrictive.
- (b) Placards, listings, instrument markings, or combinations thereof, containing those operating limitations prescribed by the AFM for visual presentation, shall be displayed in the sailplane.

CAT.POL.S.105 Weighing

- (a) The operator shall ensure that the mass and the CG of the sailplane have been established by actual weighing prior to initial entry into service. The accumulated effects of modifications and repairs on the mass and balance shall be accounted for and properly documented. Such information shall be made available to the commander. The sailplane shall be reweighed if the effect of modifications on the mass and balance is not accurately known.
- (b) The weighing shall be accomplished by the manufacturer of the sailplane or in accordance with Regulation (EC) No 2042/2003 as applicable.

CAT.POL.S.110 Performance

The commander shall only operate the sailplane if the performance is adequate to comply with the applicable rules of the air and any other restrictions applicable to the flight, the airspace or the aerodromes or operating sites used, taking into account the charting accuracy of any charts and maps used.

SECTION 5
Balloons**CAT.POL.B.100 Operating limitations**

- (a) During any phase of operation, the loading and the mass of the balloon shall comply with any limitation specified in the AFM or the operations manual (OM) if more restrictive.
- (b) Placards, listings, instrument markings, or combinations thereof, containing those operating limitations prescribed by the AFM for visual presentation, shall be displayed in the balloon.

CAT.POL.B.105 Weighing

- (a) The operator shall ensure that the mass of the balloon has been established by actual weighing prior to initial entry into service. The accumulated effects of modifications and repairs on the mass shall be accounted for and properly documented. Such information shall be made available to the commander. The balloon shall be reweighed if the effect of modifications on the mass is not accurately known.
- (b) The weighing shall be accomplished by the manufacturer of the balloon or in accordance with Regulation (EC) No 2042/2003 as applicable.

GM1 CAT.POL.B.105 Weighing

GENERAL

- (a) New balloons that have been weighed at the factory may be placed into operation without reweighing if the mass records have been adjusted for alterations or modifications to the balloon. Balloons transferred from one EU operator to another EU operator do not have to be weighed prior to use by the receiving operator unless the mass cannot be accurately established by calculation.
- (b) The initial empty mass for a balloon is the balloon empty mass determined by a weighing performed by the manufacturer of the balloon before the initial entry into service.
- (c) The mass of a balloon should be revised whenever the cumulative changes to the empty mass due to modifications or repairs exceed $\pm 10\%$ of the initial empty mass. This may be done by weighing the balloon or by calculation.

CAT.POL.B.110 System for determining the mass

- (a) The operator of a balloon shall establish a system specifying how the following items are accurately determined for each flight so to enable the commander to verify that the limitations of the AFM are complied with:
- (1) balloon empty mass;
 - (2) mass of the traffic load;
 - (3) mass of the fuel or ballast load;
 - (4) take-off mass;
 - (5) loading of the balloon performed under the supervision of the commander or qualified personnel;
 - (6) preparation and disposition of all documentation.
- (b) The mass computation based on electronic calculations shall be replicable by the commander.
- (c) The mass documentation shall be prepared prior to each flight and documented in an operational flight plan.

AMC1 CAT.POL.B.110(a)(2) System for determining the mass

TRAFFIC LOAD

Traffic load should be determined by actual weighing or using standard masses for passengers, persons other than flight crew members and baggage.

AMC2 CAT.POL.B.110(a)(2) System for determining the mass

MASS VALUES FOR PASSENGERS AND BAGGAGE

- (a) Passenger mass may be calculated on the basis of a statement by, or on behalf of, each passenger, adding to it a predetermined mass to account for hand baggage and clothing.
- (b) The predetermined mass for hand baggage and clothing should be established by the operator on the basis of experience relevant to his particular operation. In any case, it should not be less than:
- (1) 4 kg for clothing; and
 - (2) 3 kg for hand baggage.

The passengers' stated mass and the mass of passengers' clothing and hand baggage should be checked prior to boarding and adjusted, if necessary.

- (c) When determining the actual mass by weighing, passengers' personal belongings and hand baggage should be included.

AMC1 CAT.POL.B.110(a)(6) System for determining the mass

DOCUMENTATION

- (a) Mass documentation should contain the following:
- (1) balloon registration and type;
 - (2) date and flight identification;
 - (3) name of the commander;

-
- (4) name of the person who prepared the document;
 - (5) empty mass;
 - (6) mass of the fuel or ballast at take-off;
 - (7) load components including passengers, baggage and, if applicable, freight;
 - (8) take-off mass allowed by the AFM according to temperature and altitude; and
 - (10) limiting mass values.
- (b) The mass documentation should enable the commander to determine that the load is within the mass limits of the balloon.
 - (c) The information above may be available in flight planning documents, or other documents readily available for use, or mass systems.
 - (d) Any last minute change should be brought to the attention of the commander and entered in the documents containing the mass information. The operator should specify the maximum last minute change allowed in passenger numbers. New mass documentation should be prepared if this maximum number is exceeded.
 - (e) Where mass documentation is generated by a computerised mass system, the operator should verify the integrity of the output data at intervals not exceeding 6 months.
 - (f) A copy of the final mass documentation should be made available to the commander for its acceptance.

GM1 CAT.POL.B.110(a)(6) System for determining the mass

LIMITING MASS VALUES

The limiting mass values contained in the mass documentation are those stipulated in the AFM.

CAT.POL.B.115 Performance

The commander shall only operate the balloon if the performance is adequate to comply with the applicable rules of the air and any other restrictions applicable to the flight, the airspace or the aerodromes or operating sites used, taking into account the charting accuracy of any charts and maps used.

SUBPART D: INSTRUMENTS, DATA, EQUIPMENT

SECTION 1 Aeroplanes

CAT.IDE.A.100 Instruments and equipment — general

- (a) Instruments and equipment required by this Subpart shall be approved in accordance with the applicable airworthiness requirements except for the following items:
- (1) Spare fuses;
 - (2) Independent portable lights;
 - (3) An accurate time piece;
 - (4) Chart holder;
 - (5) First-aid kits;
 - (6) Emergency medical kit;
 - (7) Megaphones;
 - (8) Survival and signalling equipment;
 - (9) Sea anchors and equipment for mooring; and
 - (10) Child restraint devices.
- (b) Instruments and equipment not required by this Subpart that do not need to be approved in accordance with the applicable airworthiness requirements, but are carried on a flight, shall comply with the following:
- (1) the information provided by these instruments, equipment or accessories shall not be used by the flight crew to comply with Annex I to Regulation (EC) No 216/2008 or CAT.IDE.A.330, CAT.IDE.A.335, CAT.IDE.A.340 and CAT.IDE.A.345; and
 - (2) the instruments and equipment shall not affect the airworthiness of the aeroplane, even in the case of failures or malfunction.
- (c) If equipment is to be used by one flight crew member at his/her station during flight, it shall be readily operable from that station. When a single item of equipment is required to be operated by more than one flight crew member it shall be installed so that the equipment is readily operable from any station at which the equipment is required to be operated.
- (d) Those instruments that are used by any flight crew member shall be so arranged as to permit the flight crew member to see the indications readily from his/her station, with the minimum practicable deviation from the position and line of vision that he/she normally assumes when looking forward along the flight path.
- (e) All required emergency equipment shall be easily accessible for immediate use.

GM1 CAT.IDE.A.100(a) Instruments and equipment — general

REQUIRED INSTRUMENTS AND EQUIPMENT THAT DO NOT NEED TO BE APPROVED IN ACCORDANCE WITH COMMISSION REGULATION (EU) NO 748/2012

The functionality of non-installed instruments and equipment required by this Subpart and that do not need an equipment approval, as listed in CAT.IDE.A.100(a), should be checked against recognised industry standards appropriate to the intended purpose. The operator is responsible for ensuring the maintenance of these instruments and equipment.

GM1 CAT.IDE.A.100(b) Instruments and equipment — general

NOT REQUIRED INSTRUMENTS AND EQUIPMENT THAT DO NOT NEED TO BE APPROVED IN ACCORDANCE WITH COMMISSION REGULATION (EU) NO 748/2012, BUT ARE CARRIED ON A FLIGHT

- (a) The provision of this paragraph does not exempt any installed instrument or item of equipment from complying with Commission Regulation (EU) No 748/2012⁸. In this case, the installation should be approved as required in Commission Regulation (EU) No 748/2012 and should comply with the applicable Certification Specifications as required under the same Regulation.
- (b) The failure of additional non-installed instruments or equipment not required by this Part or by Commission Regulation (EU) No 748/2012 or any applicable airspace requirements should not adversely affect the airworthiness and/or the safe operation of the aeroplane. Examples may be the following:
 - (1) portable electronic flight bag (EFB);
 - (2) portable electronic devices carried by flight crew or cabin crew; and
 - (3) non-installed passenger entertainment equipment.

GM1 CAT.IDE.A.100(d) Instruments and equipment — general

POSITIONING OF INSTRUMENTS

This requirement implies that whenever a single instrument is required to be installed in an aeroplane operated in a multi-crew environment, the instrument needs to be visible from each flight crew station.

⁸ Commission Regulation (EU) No 748/2012 of 3 August 2012 laying down implementing rules for the airworthiness and environmental certification of aircraft and related products, parts and appliances, as well as for the certification of design and production organisations (OJ L 224, 21.8.2012, p. 1)

CAT.IDE.A.105 Minimum equipment for flight

A flight shall not be commenced when any of the aeroplane's instruments, items of equipment or functions required for the intended flight are inoperative or missing, unless:

- (a) the aeroplane is operated in accordance with the operator's MEL; or
- (b) the operator is approved by the competent authority to operate the aeroplane within the constraints of the master minimum equipment list (MMEL).

CAT.IDE.A.110 Spare electrical fuses

- (a) Aeroplanes shall be equipped with spare electrical fuses, of the ratings required for complete circuit protection, for replacement of those fuses that are allowed to be replaced in flight.
- (b) The number of spare fuses that are required to be carried shall be the higher of:
 - (1) 10 % of the number of fuses of each rating; or
 - (2) three fuses for each rating.

GM1 CAT.IDE.A.110 Spare electrical fuses

FUSES

A 'spare electrical fuse' means a replaceable fuse in the flight crew compartment, not an automatic circuit breaker, or circuit breakers in the electric compartments.

CAT.IDE.A.115 Operating lights

- (a) Aeroplanes operated by day shall be equipped with:
- (1) an anti-collision light system;
 - (2) lighting supplied from the aeroplane's electrical system to provide adequate illumination for all instruments and equipment essential to the safe operation of the aeroplane;
 - (3) lighting supplied from the aeroplane's electrical system to provide illumination in all passenger compartments; and
 - (4) an independent portable light for each required crew member readily accessible to crew members when seated at their designated stations.
- (b) Aeroplanes operated at night shall in addition be equipped with:
- (1) navigation/position lights;
 - (2) two landing lights or a single light having two separately energised filaments; and
 - (3) lights to conform with the International Regulations for Preventing Collisions at Sea if the aeroplane is operated as a seaplane.

CAT.IDE.A.120 Equipment to clear windshield

Aeroplanes with an MCTOM of more than 5 700 kg shall be equipped at each pilot station with a means to maintain a clear portion of the windshield during precipitation.

AMC1 CAT.IDE.A.120 Equipment to clear windshield

MEANS TO MAINTAIN A CLEAR PORTION OF THE WINDSHIELD DURING PRECIPITATION

The means used to maintain a clear portion of the windshield during precipitation should be windshield wipers or an equivalent.

CAT.IDE.A.125 Operations under VFR by day — flight and navigational instruments and associated equipment

- (a) Aeroplanes operated under VFR by day shall be equipped with the following equipment, available at the pilot's station:
- (1) A means of measuring and displaying:
 - (i) Magnetic heading;
 - (ii) Time in hours, minutes, and seconds;
 - (iii) Pressure altitude;
 - (iv) Indicated airspeed;
 - (v) Vertical speed;
 - (vi) Turn and slip;
 - (vii) Attitude;
 - (viii) Heading;
 - (ix) Outside air temperature; and
 - (x) Mach number whenever speed limitations are expressed in terms of Mach number.
 - (2) A means of indicating when the supply of power to the required flight instruments is not adequate.
- (b) Whenever two pilots are required for the operation, an additional separate means of displaying the following shall be available for the second pilot:
- (1) Pressure altitude;
 - (2) Indicated airspeed;
 - (3) Vertical speed;
 - (4) Turn and slip;
 - (5) Attitude; and
 - (6) Heading.
- (c) A means for preventing malfunction of the airspeed indicating systems due to condensation or icing shall be available for:
- (1) aeroplanes with an MCTOM of more than 5 700 kg or an MOPSC of more than nine; and
 - (2) aeroplanes first issued with an individual CofA on or after 1 April 1999.
- (d) Single engine aeroplanes first issued with an individual CofA before 22 May 1995 are exempted from the requirements of (a)(1)(vi), (a)(1)(vii), (a)(1)(viii) and (a)(1)(ix) if the compliance would require retrofitting.

AMC1 CAT.IDE.A.125 & CAT.IDE.A.130 Operations under VFR by day & Operations under IFR or at night — flight and navigational instruments and associated equipment

INTEGRATED INSTRUMENTS

- (a) Individual equipment requirements may be met by combinations of instruments, by integrated flight systems or by a combination of parameters on electronic displays, provided that the information so available to each required pilot is not less than that required in the applicable

operational requirements, and the equivalent safety of the installation has been shown during type certification approval of the aeroplane for the intended type of operation.

- (b) The means of measuring and indicating turn and slip, aeroplane attitude and stabilised aeroplane heading may be met by combinations of instruments or by integrated flight director systems, provided that the safeguards against total failure, inherent in the three separate instruments, are retained.

AMC2 CAT.IDE.A.125 Operations under VFR by day — flight and navigational instruments and associated equipment

LOCAL FLIGHTS

For flights that do not exceed 60 minutes' duration, that take off and land at the same aerodrome and that remain within 50 NM of that aerodrome, an equivalent means of complying with CAT.IDE.A.125 (a)(1)(vi) may be:

- (a) a turn and slip indicator;
- (b) a turn coordinator; or
- (c) both an attitude indicator and a slip indicator.

AMC1 CAT.IDE.A.125(a)(1)(i) & CAT.IDE.A.130(a)(1) Operations under VFR by day & Operations under IFR or at night — flight and navigational instruments and associated equipment

MEANS OF MEASURING AND DISPLAYING MAGNETIC HEADING

The means of measuring and displaying magnetic direction should be a magnetic compass or equivalent.

AMC1 CAT.IDE.A.125(a)(1)(ii) & CAT.IDE.A.130(a)(2) Operations under VFR by day & Operations under IFR or at night — flight and navigational instruments and associated equipment

MEANS OF MEASURING AND DISPLAYING THE TIME

An acceptable means of compliance is a clock displaying hours, minutes and seconds, with a sweep-second pointer or digital presentation.

AMC1 CAT.IDE.A.125(a)(1)(iii) & CAT.IDE.A.130(b) Operations under VFR by day & Operations under IFR or at night — flight and navigational instruments and associated equipment

CALIBRATION OF THE MEANS OF MEASURING AND DISPLAYING PRESSURE ALTITUDE

The instrument measuring and displaying pressure altitude should be of a sensitive type calibrated in feet (ft), with a sub-scale setting, calibrated in hectopascals/millibars, adjustable for any barometric pressure likely to be set during flight.

AMC1 CAT.IDE.A.125(a)(1)(iv) & CAT.IDE.A.130(a)(3) Operations under VFR by day & Operations under IFR or at night — flight and navigational instruments and associated equipment

CALIBRATION OF THE INSTRUMENT INDICATING AIRSPEED

The instrument indicating airspeed should be calibrated in knots (kt).

AMC1 CAT.IDE.A.125(a)(1)(ix) & CAT.IDE.A.130(a)(8) Operations under VFR by day & operations under IFR or at night — flight and navigational instruments and associated equipment

MEANS OF DISPLAYING OUTSIDE AIR TEMPERATURE

- (a) The means of displaying outside air temperature should be calibrated in degrees Celsius.
- (b) The means of displaying outside air temperature may be an air temperature indicator that provides indications that are convertible to outside air temperature.

AMC1 CAT.IDE.A.125(b) & CAT.IDE.A.130(h) Operations under VFR by day & Operations under IFR or at night — flight and navigational instruments and associated equipment

MULTI-PILOT OPERATIONS — DUPLICATE INSTRUMENTS

Duplicate instruments should include separate displays for each pilot and separate selectors or other associated equipment where appropriate.

AMC1 CAT.IDE.A.125(c) & CAT.IDE.A.130(d) Operations under VFR by day & Operations under IFR or at night — flight and navigational instruments and associated equipment

MEANS OF PREVENTING MALFUNCTION DUE TO CONDENSATION OR ICING

The means of preventing malfunction due to either condensation or icing of the airspeed indicating system should be a heated pitot tube or equivalent.

GM1 CAT.IDE.A.125 & CAT.IDE.A.130 Operations under VFR by day & Operations under IFR or at night — flight and navigational instruments and associated equipment

SUMMARY TABLE

Table 1

Flight and navigational instruments and associated equipment

SERIAL		FLIGHTS UNDER VFR		FLIGHTS UNDER IFR OR AT NIGHT	
		SINGLE-PILOT	TWO PILOTS REQUIRED	SINGLE-PILOT	TWO PILOTS REQUIRED
(a)		(b)	(c)	(d)	(e)
1	Magnetic direction	1	1	1	1
2	Time	1	1	1	1
3	Pressure altitude	1	2	2 Note (5)	2 Note (5)
4	Indicated airspeed	1	2	1	2
5	Vertical speed	1	2	1	2
6	Turn and slip or turn coordinator	1 Note (1)	2 Note (1) & Note (2)	1 Note (4)	2 Note (4)
7	Attitude	1	2	1	2

		Note (1)	Note (1) & Note (2)		
8	Stabilised direction	1 Note (1)	2 Note (1) & Note (2)	1	2
9	Outside air temperature	1	1	1	1
10	Mach number indicator	See Note (3)			
11	Airspeed protection icing	1 Note (6)	2 Note (6)	1	2
12	Airspeed protection icing failure indicating			1 Note (7)	2 Note (7)
13	Static pressure source			2	2
14	Standby attitude indicator			1 Note (8)	1 Note (8)
15	Chart holder			1 Note (6)	1 Note (6)

Note (1) For local flights (A to A, 50 NM radius, not more than 60 minutes' duration), the instruments at serials (a)(6) and (a)(8) may be replaced by either a turn and slip indicator, or a turn coordinator, or both an attitude indicator and a slip indicator.

Note (2) The substitute instruments permitted by Note (1) above should be provided at each pilot's station.

Note (3) A Mach number indicator is required for each pilot whenever compressibility limitations are not otherwise indicated by airspeed indicators.

Note (4) For IFR or at night, a turn and slip indicator, or a slip indicator and a third (standby) attitude indicator certified according to CS 25.1303 (b)(4) or equivalent, is required.

Note (5) Except for unpressurised aeroplanes operating below 10 000 ft, neither three pointers, nor drum-pointer altimeters satisfy the requirement.

Note (6) Applicable only to aeroplanes with a maximum certified take-off mass (MCTOM) of more than 5 700 kg, or with an MOPSC of more than 9. It also applies to all aeroplanes first issued with an individual certificate of airworthiness (CofA) on or after 1 April 1999.

Note (7) The pitot heater failure annunciation applies to any aeroplane issued with an individual CofA on or after 1 April 1998. It also applies before that date when: the aeroplane has an MCTOM of more than 5 700 kg and an MOPSC greater than 9.

Note (8) Applicable only to aeroplanes with an MCTOM of more than 5 700 kg, or with an MOPSC of more than 9.

CAT.IDE.A.130 Operations under IFR or at night — flight and navigational instruments and associated equipment

Aeroplanes operated under VFR at night or under IFR shall be equipped with the following equipment, available at the pilot's station:

- (a) A means of measuring and displaying:
 - (1) Magnetic heading;
 - (2) Time in hours, minutes and seconds;
 - (3) Indicated airspeed;
 - (4) Vertical speed;
 - (5) Turn and slip, or in the case of aeroplanes equipped with a standby means of measuring and displaying attitude, slip;
 - (6) Attitude;
 - (7) Stabilised heading;
 - (8) Outside air temperature; and
 - (9) Mach number whenever speed limitations are expressed in terms of Mach number.
- (b) Two means of measuring and displaying pressure altitude.
- (c) A means of indicating when the supply of power to the required flight instruments is not adequate.
- (d) A means for preventing malfunction of the airspeed indicating systems required in (a)(3) and (h)(2) due to condensation or icing.
- (e) A means of annunciating to the flight crew the failure of the means required in (d) for aeroplanes:
 - (1) issued with an individual CofA on or after 1 April 1998; or
 - (2) issued with an individual CofA before 1 April 1998 with an MCTOM of more than 5 700 kg, and with an MOPSC of more than nine.
- (f) Except for propeller-driven aeroplanes with an MCTOM of 5 700 kg or less, two independent static pressure systems.
- (g) One static pressure system and one alternate source of static pressure for propeller-driven aeroplanes with an MCTOM of 5 700 kg or less.
- (h) Whenever two pilots are required for the operation, a separate means of displaying for the second pilot:
 - (1) Pressure altitude;
 - (2) Indicated airspeed;
 - (3) Vertical speed;
 - (4) Turn and slip;
 - (5) Attitude; and
 - (6) Stabilised heading.
- (i) A standby means of measuring and displaying attitude capable of being used from either pilot's station for aeroplanes with an MCTOM of more than 5 700 kg or an MOPSC of more than nine that:

- (1) is powered continuously during normal operation and, after a total failure of the normal electrical generating system, is powered from a source independent from the normal electrical generating system;
 - (2) provides reliable operation for a minimum of 30 minutes after total failure of the normal electrical generating system, taking into account other loads on the emergency power supply and operational procedures;
 - (3) operates independently of any other means of measuring and displaying attitude;
 - (4) is operative automatically after total failure of the normal electrical generating system;
 - (5) is appropriately illuminated during all phases of operation, except for aeroplanes with an MCTOM of 5 700 kg or less, already registered in a Member State on 1 April 1995 and equipped with a standby attitude indicator in the left-hand instrument panel;
 - (6) is clearly evident to the flight crew when the standby attitude indicator is being operated by emergency power; and
 - (7) where the standby attitude indicator has its own dedicated power supply, has an associated indication, either on the instrument or on the instrument panel, when this supply is in use.
- (j) A chart holder in an easily readable position that can be illuminated for night operations.

AMC1 CAT.IDE.A.125 & CAT.IDE.A.130 Operations under VFR by day & Operations under IFR or at night — flight and navigational instruments and associated equipment

See [here](#).

AMC1 CAT.IDE.A.125(a)(1)(i) & CAT.IDE.A.130(a)(1) Operations under VFR by day & Operations under IFR or at night — flight and navigational instruments and associated equipment

See [here](#).

AMC1 CAT.IDE.A.125(a)(1)(ii) & CAT.IDE.A.130(a)(2) Operations under VFR by day & Operations under IFR or at night — flight and navigational instruments and associated equipment

See [here](#).

AMC1 CAT.IDE.A.125(a)(1)(iv) & CAT.IDE.A.130(a)(3) Operations under VFR by day & Operations under IFR or at night — flight and navigational instruments and associated equipment

See [here](#).

AMC1 CAT.IDE.A.130(a)(5) Operations under IFR or at night — flight and navigational instruments and associated equipment

SLIP INDICATOR

If only slip indication is provided, the means of measuring and displaying standby attitude should be certified according to CS 25.1303(b)(4) or equivalent.

AMC1 CAT.IDE.A.125(a)(1)(ix) & CAT.IDE.A.130(a)(8) Operations under VFR by day & operations under IFR or at night — flight and navigational instruments and associated equipment

See [here](#).

AMC1 CAT.IDE.A.125(a)(1)(iii) & CAT.IDE.A.130(b) Operations under VFR by day & Operations under IFR or at night — flight and navigational instruments and associated equipment

See [here](#).

AMC2 CAT.IDE.A.130(b) Operations under IFR or at night — flight and navigational instruments and associated equipment**ALTIMETERS — IFR OR NIGHT OPERATIONS**

Except for unpressurised aeroplanes operating below 10 000 ft, the altimeters of aeroplanes operating under IFR or at night should have counter drum-pointer or equivalent presentation.

AMC1 CAT.IDE.A.125(c) & CAT.IDE.A.130(d) Operations under VFR by day & Operations under IFR or at night — flight and navigational instruments and associated equipment

See [here](#).

AMC1 CAT.IDE.A.130(e) Operations under IFR or at night — flight and navigational instruments and associated equipment**MEANS OF INDICATING FAILURE OF THE AIRSPEED INDICATING SYSTEM'S MEANS OF PREVENTING MALFUNCTION DUE TO EITHER CONDENSATION OR ICING**

A combined means of indicating failure of the airspeed indicating system's means of preventing malfunction due to either condensation or icing is acceptable provided that it is visible from each flight crew station and that there is a means to identify the failed heater in systems with two or more sensors.

AMC1 CAT.IDE.A.125(b) & CAT.IDE.A.130(h) Operations under VFR by day & Operations under IFR or at night — flight and navigational instruments and associated equipment

See [here](#).

AMC1 CAT.IDE.A.130(i)(5) Operations under IFR or at night — flight and navigational instruments and associated equipment**ILLUMINATION OF STANDBY MEANS OF MEASURING AND DISPLAYING ATTITUDE**

The standby means of measuring and displaying attitude should be illuminated so as to be clearly visible under all conditions of daylight and artificial lighting.

AMC1 CAT.IDE.A.130(j) Operations under IFR or at night — flight and navigational instruments and associated equipment**CHART HOLDER**

An acceptable means of compliance with the chart holder requirement is to display a pre-composed chart on an electronic flight bag (EFB).

GM1 CAT.IDE.A.125 & CAT.IDE.A.130 Operations under VFR by day & Operations under IFR or at night — flight and navigational instruments and associated equipment

See [here](#).

CAT.IDE.A.135 Additional equipment for single-pilot operation under IFR

Aeroplanes operated under IFR with a single-pilot shall be equipped with an autopilot with at least altitude hold and heading mode.

CAT.IDE.A.140 Altitude alerting system

- (a) The following aeroplanes shall be equipped with an altitude alerting system:
- (1) turbine propeller powered aeroplanes with an MCTOM of more than 5 700 kg or having an MOPSC of more than nine; and
 - (2) aeroplanes powered by turbo-jet engines.
- (b) The altitude alerting system shall be capable of:
- (1) alerting the flight crew when approaching a preselected altitude; and
 - (2) alerting the flight crew by at least an aural signal, when deviating from a preselected altitude.
- (c) Notwithstanding (a), aeroplanes with an MCTOM of 5 700 kg or less, having an MOPSC of more than nine, first issued with an individual CofA before 1 April 1972 and already registered in a Member State on 1 April 1995 are exempted from being equipped with an altitude alerting system.

CAT.IDE.A.150 Terrain awareness warning system (TAWS)

- (a) Turbine-powered aeroplanes having an MCTOM of more than 5 700 kg or an MOPSC of more than nine shall be equipped with a TAWS that meets the requirements for Class A equipment as specified in an acceptable standard.
- (b) Reciprocating-engine-powered aeroplanes with an MCTOM of more than 5 700 kg or an MOPSC of more than nine shall be equipped with a TAWS that meets the requirement for Class B equipment as specified in an acceptable standard.

AMC1 CAT.IDE.A.150 Terrain awareness warning system (TAWS)**EXCESSIVE DOWNWARDS GLIDE SLOPE DEVIATION WARNING FOR CLASS A TAWS**

The requirement for a Class A TAWS to provide a warning to the flight crew for excessive downwards glide slope deviation should apply to all final approach glide slopes with angular vertical navigation (VNAV) guidance, whether provided by the instrument landing system (ILS), microwave landing system (MLS), satellite based augmentation system approach procedure with vertical guidance (SBAS APV (localiser performance with vertical guidance approach LPV)), ground-based augmentation system (GBAS (GPS landing system, GLS) or any other systems providing similar guidance. The same requirement should not apply to systems providing vertical guidance based on barometric VNAV.

GM1 CAT.IDE.A.150 Terrain awareness warning system (TAWS)**ACCEPTABLE STANDARD FOR TAWS**

An acceptable standard for Class A and Class B TAWS may be the applicable European technical standards order (ETSO) issued by the Agency or equivalent.

CAT.IDE.A.155 Airborne collision avoidance system (ACAS)

Unless otherwise provided for by Regulation (EU) No 1332/2011, turbine-powered aeroplanes with an MCTOM of more than 5 700 kg or an MOPSC of more than 19 shall be equipped with ACAS II.

CAT.IDE.A.160 Airborne weather detecting equipment

The following shall be equipped with airborne weather detecting equipment when operated at night or in IMC in areas where thunderstorms or other potentially hazardous weather conditions, regarded as detectable with airborne weather detecting equipment, may be expected to exist along the route:

- (a) pressurised aeroplanes;
- (b) non-pressurised aeroplanes with an MCTOM of more than 5 700 kg; and
- (c) non-pressurised aeroplanes with an MOPSC of more than nine.

AMC1 CAT.IDE.A.160 Airborne weather detecting equipment**GENERAL**

The airborne weather detecting equipment should be an airborne weather radar, except for propeller-driven pressurised aeroplanes with an MCTOM not more than 5 700 kg and an MOPSC of not more than 9, for which other equipment capable of detecting thunderstorms and other potentially hazardous weather conditions, regarded as detectable with airborne weather radar equipment, are also acceptable.

CAT.IDE.A.165 Additional equipment for operations in icing conditions at night

- (a) Aeroplanes operated in expected or actual icing conditions at night shall be equipped with a means to illuminate or detect the formation of ice.
- (b) The means to illuminate the formation of ice shall not cause glare or reflection that would handicap crew members in the performance of their duties.

CAT.IDE.A.170 Flight crew interphone system

Aeroplanes operated by more than one flight crew member shall be equipped with a flight crew interphone system, including headsets and microphones for use by all flight crew members.

AMC1 CAT.IDE.A.170 Flight crew interphone system

TYPE OF FLIGHT CREW INTERPHONE

The flight crew interphone system should not be of a handheld type.

CAT.IDE.A.175 Crew member interphone system

Aeroplanes with an MCTOM of more than 15 000 kg, or with an MOPSC of more than 19 shall be equipped with a crew member interphone system, except for aeroplanes first issued with an individual CofA before 1 April 1965 and already registered in a Member State on 1 April 1995.

AMC1 CAT.IDE.A.175 Crew member interphone system

SPECIFICATIONS

The crew member interphone system should:

- (a) operate independently of the public address system except for handsets, headsets, microphones, selector switches and signalling devices;
- (b) in the case of aeroplanes where at least one cabin crew member is required, be readily accessible for use at required cabin crew member stations close to each separate or pair of floor level emergency exits;
- (c) in the case of aeroplanes where at least one cabin crew member is required, have an alerting system incorporating aural or visual signals for use by flight and cabin crew;
- (d) have a means for the recipient of a call to determine whether it is a normal call or an emergency call that uses one or a combination of the following:
 - (1) lights of different colours;
 - (2) codes defined by the operator (e.g. different number of rings for normal and emergency calls); or
 - (3) any other indicating signal specified in the operations manual;
- (e) provide two-way communication between:
 - (1) the flight crew compartment and each passenger compartment, in the case of aeroplanes where at least one cabin crew member is required;
 - (2) the flight crew compartment and each galley located other than on a passenger deck level, in the case of aeroplanes where at least one cabin crew member is required;
 - (3) the flight crew compartment and each remote crew compartment and crew member station that is not on the passenger deck and is not accessible from a passenger compartment; and
 - (4) ground personnel and at least two flight crew members. This interphone system for use by the ground personnel should be, where practicable, so located that the personnel using the system may avoid detection from within the aeroplane; and
- (f) be readily accessible for use from each required flight crew station in the flight crew compartment.

CAT.IDE.A.180 Public address system

Aeroplanes with an MOPSC of more than 19 shall be equipped with a public address system.

AMC1 CAT.IDE.A.180 Public address system

SPECIFICATIONS

The public address system should:

- (a) operate independently of the interphone systems except for handsets, headsets, microphones, selector switches and signalling devices;
- (b) be readily accessible for immediate use from each required flight crew station;
- (c) have, for each floor level passenger emergency exit that has an adjacent cabin crew seat, a microphone operable by the seated cabin crew member, except that one microphone may serve more than one exit, provided the proximity of exits allows unassisted verbal communication between seated cabin crew members;
- (d) be operable within 10 seconds by a cabin crew member at each of those stations; and
- (e) be audible at all passenger seats, lavatories, galleys, cabin crew seats and work stations, and other crew remote areas.

CAT.IDE.A.185 Cockpit voice recorder

- (a) The following aeroplanes shall be equipped with a cockpit voice recorder (CVR):
- (1) aeroplanes with an MCTOM of more than 5 700 kg; and
 - (2) multi-engined turbine-powered aeroplanes with an MCTOM of 5 700 kg or less, with an MOPSC of more than nine and first issued with an individual CofA on or after 1 January 1990.
- (b) Until 31 December 2018, the CVR shall be capable of retaining the data recorded during at least:
- (1) the preceding 2 hours in the case of aeroplanes referred to in (a)(1) when the individual CofA has been issued on or after 1 April 1998;
 - (2) the preceding 30 minutes for aeroplanes referred to in (a)(1) when the individual CofA has been issued before 1 April 1998; or
 - (3) the preceding 30 minutes, in the case of aeroplanes referred to in (a)(2).
- (c) By 1 January 2019 at the latest, the CVR shall be capable of retaining the data recorded during at least:
- (1) the preceding 25 hours for aeroplanes with an MCTOM of more than 27 000 kg and first issued with an individual CofA on or after 1 January 2021; or
 - (2) the preceding 2 hours in all other cases.
- (d) By 1 January 2019 at the latest, the CVR shall record on means other than magnetic tape or magnetic wire.
- (e) The CVR shall record with reference to a timescale:
- (1) voice communications transmitted from or received in the flight crew compartment by radio;
 - (2) flight crew members' voice communications using the interphone system and the public address system, if installed;
 - (3) the aural environment of the flight crew compartment, including without interruption:
 - (i) for aeroplanes first issued with an individual CofA on or after 1 April 1998, the audio signals received from each boom and mask microphone in use;
 - (ii) for aeroplanes referred to in (a)(2) and first issued with an individual CofA before 1 April 1998, the audio signals received from each boom and mask microphone, where practicable;
 - (4) voice or audio signals identifying navigation or approach aids introduced into a headset or speaker.
- (f) The CVR shall start to record prior to the aeroplane moving under its own power and shall continue to record until the termination of the flight when the aeroplane is no longer capable of moving under its own power. In addition, in the case of aeroplanes issued with an individual CofA on or after 1 April 1998, the CVR shall start automatically to record prior to the aeroplane moving under its own power and continue to record until the termination of the flight when the aeroplane is no longer capable of moving under its own power.
- (g) In addition to (f), depending on the availability of electrical power, the CVR shall start to record as early as possible during the cockpit checks prior to engine start at the beginning of the flight until the cockpit checks immediately following engine shutdown at the end of the flight, in the case of:

- (1) aeroplanes referred to in (a)(1) and issued with an individual CofA on or after 1 April 1998;
or
 - (2) aeroplanes referred to in (a)(2).
- (h) If the CVR is not deployable, it shall have a device to assist in locating it under water. By 16 June 2018 at the latest, this device shall have a minimum underwater transmission time of 90 days. If the CVR is deployable, it shall have an automatic emergency locator transmitter.

AMC1 CAT.IDE.A.185 Cockpit voice recorder

OPERATIONAL PERFORMANCE REQUIREMENTS

- (a) For aeroplanes first issued with an individual CofA on or after 1 April 1998 and before 1 January 2016, the operational performance requirements for cockpit voice recorders (CVRs) and their dedicated equipment should be those laid down in the European Organisation for Civil Aviation Equipment (EUROCAE) Document ED-56A (Minimum Operational Performance Requirements For Cockpit Voice Recorder Systems) dated December 1993, or EUROCAE Document ED-112 (Minimum Operational Performance Specification for Crash Protected Airborne Recorder Systems) dated March 2003, including Amendments No 1 and No 2, or any later equivalent standard produced by EUROCAE.
- (b) For aeroplanes first issued with an individual CofA on or after 1 January 2016:
- (1) the operational performance requirements for CVRs should be those laid down in EUROCAE Document ED-112 (Minimum Operational Performance Specification for Crash Protected Airborne Recorder Systems) dated March 2003, including Amendments No 1 and No 2, or any later equivalent standard produced by EUROCAE; and
 - (2) the operational performance requirements for equipment dedicated to the CVR should be those laid down in the European Organisation for Civil Aviation Equipment (EUROCAE) Document ED-56A (Minimum Operational Performance Requirements For Cockpit Voice Recorder Systems) dated December 1993, or EUROCAE Document ED-112 (Minimum Operational Performance Specification for Crash Protected Airborne Recorder Systems) dated March 2003, including Amendments n°1 and n°2, or any later equivalent standard produced by EUROCAE.

CAT.IDE.A.190 Flight data recorder

- (a) The following aeroplanes shall be equipped with a flight data recorder (FDR) that uses a digital method of recording and storing data and for which a method of readily retrieving that data from the storage medium is available:
- (1) aeroplanes with an MCTOM of more than 5 700 kg and first issued with an individual CofA on or after 1 June 1990;
 - (2) turbine-engined aeroplanes with an MCTOM of more than 5 700 kg and first issued with an individual CofA before 1 June 1990; and
 - (3) multi-engined turbine-powered aeroplanes with an MCTOM of 5 700 kg or less, with an MOPSC of more than nine and first issued with an individual CofA on or after 1 April 1998.
- (b) The FDR shall record:
- (1) time, altitude, airspeed, normal acceleration and heading and be capable of retaining the data recorded during at least the preceding 25 hours for aeroplanes referred to in (a)(2) with an MCTOM of less than 27 000 kg;
 - (2) the parameters required to determine accurately the aeroplane flight path, speed, attitude, engine power and configuration of lift and drag devices and be capable of retaining the data recorded during at least the preceding 25 hours, for aeroplanes referred to in (a)(1) with an MCTOM of less than 27 000 kg and first issued with an individual CofA before 1 January 2016;
 - (3) the parameters required to determine accurately the aeroplane flight path, speed, attitude, engine power, configuration and operation and be capable of retaining the data recorded during at least the preceding 25 hours, for aeroplanes referred to in (a)(1) and (a)(2) with an MCTOM of over 27 000 kg and first issued with an individual CofA before 1 January 2016;
 - (4) the parameters required to determine accurately the aeroplane flight path, speed, attitude, engine power and configuration of lift and drag devices and be capable of retaining the data recorded during at least the preceding 10 hours, in the case of aeroplanes referred to in (a)(3) and first issued with an individual CofA before 1 January 2016; or
 - (5) the parameters required to determine accurately the aeroplane flight path, speed, attitude, engine power, configuration and operation and be capable of retaining the data recorded during at least the preceding 25 hours, for aeroplanes referred to in (a)(1) and (a)(3) and first issued with an individual CofA on or after 1 January 2016.
- (c) Data shall be obtained from aeroplane sources that enable accurate correlation with information displayed to the flight crew.
- (d) The FDR shall start to record the data prior to the aeroplane being capable of moving under its own power and shall stop after the aeroplane is incapable of moving under its own power. In addition, in the case of aeroplanes issued with an individual CofA on or after 1 April 1998, the FDR shall start automatically to record the data prior to the aeroplane being capable of moving under its own power and shall stop automatically after the aeroplane is incapable of moving under its own power.
- (e) If the FDR is not deployable, it shall have a device to assist in locating it under water. By 16 June 2018 at the latest, this device shall have a minimum underwater transmission time of 90 days. If the FDR is deployable, it shall have an automatic emergency locator transmitter.

AMC1.1 CAT.IDE.A.190 Flight data recorder**OPERATIONAL PERFORMANCE REQUIREMENTS FOR AEROPLANES FIRST ISSUED WITH AN INDIVIDUAL CoFA ON OR AFTER 1 JANUARY 2016 AND BEFORE 1 JANUARY 2023**

- (a) The operational performance requirements for flight data recorders (FDRs) should be those laid down in EUROCAE Document ED-112 (Minimum Operational Performance Specification for Crash Protected Airborne Recorder Systems) dated March 2003, including amendments No 1 and No 2, or any later equivalent standard produced by EUROCAE.
- (b) The FDR should record with reference to a timescale the list of parameters in Table 1 and Table 2, as applicable.
- (c) The parameters to be recorded should meet the performance specifications (range, sampling intervals, accuracy limits and resolution in read-out) as defined in the relevant tables of EUROCAE Document ED-112, including amendments No 1 and No 2, or any later equivalent standard produced by EUROCAE.

Table 1

FDR — all aeroplanes

No*	Parameter
1a	Time; or
1b	Relative time count
1c	Global navigation satellite system (GNSS) time synchronisation
2	Pressure altitude
3a	Indicated airspeed; or Calibrated airspeed
4	Heading (primary flight crew reference) — when true or magnetic heading can be selected, the primary heading reference, a discrete indicating selection, should be recorded
5	Normal acceleration
6	Pitch attitude
7	Roll attitude
8	Manual radio transmission keying and CVR/FDR synchronisation reference
9	Engine thrust/power
9a	Parameters required to determine propulsive thrust/power on each engine
9b	Flight crew compartment thrust/power lever position for aeroplanes with non-mechanically linked flight crew compartment — engine control
14	Total or outside air temperature
16	Longitudinal acceleration (body axis)

No*	Parameter
17	Lateral acceleration
18	Primary flight control surface and/or primary flight control pilot input (for aeroplanes with control systems in which movement of a control surface will back drive the pilot's control, 'or' applies. For aeroplanes with control systems in which movement of a control surface will not back drive the pilot's control, 'and' applies. For multiple or split surfaces, a suitable combination of inputs is acceptable in lieu of recording each surface separately. For aeroplanes that have a flight control break-away capability that allows either pilot to operate the controls independently, record both inputs):
18a	Pitch axis
18b	Roll axis
18c	Yaw axis
19	Pitch trim surface position
23	Marker beacon passage
24	Warnings — in addition to the master warning, each 'red' warning (including smoke warnings from other compartments) should be recorded when the warning condition cannot be determined from other parameters or from the CVR
25	Each navigation receiver frequency selection
27	Air—ground status. Air—ground status and a sensor of each landing gear if installed

* The number in the left hand column reflects the serial number depicted in EUROCAE ED-112.

Table 2

FDR — Aeroplanes for which the data source for the parameter is either used by aeroplane systems or is available on the instrument panel for use by the flight crew to operate the aeroplane

No*	Parameter
10	Flaps
10a	Trailing edge flap position
10b	Flight crew compartment control selection
11	Slats
11a	Leading edge flap (slat) position
11b	Flight crew compartment control selection
12	Thrust reverse status
13	Ground spoiler and speed brake

No*	Parameter
13a	Ground spoiler position
13b	Ground spoiler selection
13c	Speed brake position
13d	Speed brake selection
15	Autopilot, autothrottle and automatic flight control system (AFCS) mode and engagement status
20	Radio altitude. For auto-land/Category III operations, each radio altimeter should be recorded.
21	Vertical deviation — the approach aid in use should be recorded. For auto-land/Category III operations, each system should be recorded.
21a	ILS/GPS/GLS glide path
21b	MLS elevation
21c	Integrated approach navigation (IAN)/integrated area navigation (IRNAV), vertical deviation
22	Horizontal deviation — the approach aid in use should be recorded. For auto land/Category III operations, each system should be recorded.
22a	ILS/GPS/GLS localiser
22b	MLS azimuth
22c	GNSS approach path/IRNAV lateral deviation
26	Distance measuring equipment (DME) 1 and 2 distances
26a	Distance to runway threshold (GLS)
26b	Distance to missed approach point (IRNAV/IAN)
28	Ground proximity warning system (GPWS)/terrain awareness warning system (TAWS)/ground collision avoidance system (GCAS) status:
28a	Selection of terrain display mode, including pop-up display status
28b	Terrain alerts, including cautions and warnings and advisories
28c	On/off switch position
29	Angle of attack
30	Low pressure warning (each system):
30a	Hydraulic pressure
30b	Pneumatic pressure
31	Ground speed
32	Landing gear:
32a	Landing gear position

No*	Parameter
32b	Gear selector position
33	Navigation data:
33a	Drift angle
33b	Wind speed
33c	Wind direction
33d	Latitude
33e	Longitude
33f	GNSS augmentation in use
34	Brakes:
34a	Left and right brake pressure
34b	Left and right brake pedal position
35	Additional engine parameters (if not already recorded in parameter 9 of Table 1 of AMC1 CAT.IDE.190.A, and if the aeroplane is equipped with a suitable data source):
35a	Engine pressure ratio (EPR)
35b	N1
35c	Indicated vibration level
35d	N2
35e	Exhaust gas temperature (EGT)
35f	Fuel flow
35g	Fuel cut-off lever position
35h	N3
36	Traffic alert and collision avoidance system (TCAS)/airborne collision avoidance system (ACAS) — a suitable combination of discrettes should be recorded to determine the status of the system:
36a	Combined control
36b	Vertical control
36c	Up advisory
36d	Down advisory
36e	Sensitivity level
37	Wind shear warning
38	Selected barometric setting
38a	Pilot selected barometric setting
38b	Co-pilot selected barometric setting

No*	Parameter
39	Selected altitude (all pilot selectable modes of operation) — to be recorded for the aeroplane where the parameter is displayed electronically
40	Selected speed (all pilot selectable modes of operation) — to be recorded for the aeroplane where the parameter is displayed electronically
41	Selected Mach (all pilot selectable modes of operation) — to be recorded for the aeroplane where the parameter is displayed electronically
42	Selected vertical speed (all pilot selectable modes of operation) — to be recorded for the aeroplane where the parameter is displayed electronically
43	Selected heading (all pilot selectable modes of operation) — to be recorded for the aeroplane where the parameter is displayed electronically
44	Selected flight path (All pilot selectable modes of operation) — to be recorded for the aeroplane where the parameter is displayed electronically
44a	Course/desired track (DSTRK)
44b	Path angle
44c	Coordinates of final approach path (IRNAV/IAN)
45	Selected decision height — to be recorded for the aeroplane where the parameter is displayed electronically
46	Electronic flight instrument system (EFIS) display format:
46a	Pilot
46b	Co-pilot
47	Multi-function/engine/alerts display format
48	Alternating current (AC) electrical bus status — each bus
49	Direct current (DC) electrical bus status — each bus
50	Engine bleed valve position
51	Auxiliary power unit (APU) bleed valve position
52	Computer failure — (all critical flight and engine control systems)
53	Engine thrust command
54	Engine thrust target
55	Computed centre of gravity (CG)
56	Fuel quantity in CG trim tank

No*	Parameter
57	Head up display in use
58	Para visual display on
59	Operational stall protection, stick shaker and pusher activation
60	Primary navigation system reference:
60a	GNSS
60b	Inertial navigational system (INS)
60c	VHF omnidirectional radio range (VOR)/distance measuring equipment (DME)
60d	MLS
60e	Loran C
60f	ILS
61	Ice detection
62	Engine warning — each engine vibration
63	Engine warning — each engine over temperature
64	Engine warning — each engine oil pressure low
65	Engine warning — each engine over speed
66	Yaw trim surface position
67	Roll trim surface position
68	Yaw or sideslip angle
69	De-icing and/or anti-icing systems selection
70	Hydraulic pressure — each system
71	Loss of cabin pressure
72	Trim control input position in the flight crew compartment, pitch — when mechanical means for control inputs are not available, displayed trim position or trim command should be recorded.
73	Trim control input position in the flight crew compartment, roll — when mechanical means for control inputs are not available, displayed trim position or trim command should be recorded.
74	Trim control input position in the flight crew compartment, yaw — when mechanical means for control inputs are not available, displayed trim position or trim command should be recorded.
75	All flight control input forces (for fly-by-wire flight control systems, where control surface position is a function of the displacement of the control input device only, it is not necessary

No*	Parameter
75a	to record this parameter): Control wheel
75b	Control column
75c	Rudder pedal
76	Event marker
77	Date
78	Actual navigation performance (ANP) or estimate of position error (EPE) or estimate of position uncertainty (EPU)

* The number in the left hand column reflects the serial number depicted in EUROCAE Document ED-112.

AMC1.2 CAT.IDE.A.190 Flight data recorder

OPERATIONAL PERFORMANCE REQUIREMENTS FOR AEROPLANES FIRST ISSUED WITH AN INDIVIDUAL CofA ON OR AFTER 1 JANUARY 2023

- (a) The operational performance requirements for FDRs should be those laid down in EUROCAE Document 112A (Minimum Operational Performance Specification for Crash Protected Airborne Recorder Systems) dated September 2013, or any later equivalent standard produced by EUROCAE.
- (b) The FDR should, with reference to a timescale, record:
- (1) the list of parameters in Table 1 below;
 - (2) the additional parameters listed in Table 2 below, when the information data source for the parameter is used by aeroplane systems or is available on the instrument panel for use by the flight crew to operate the aeroplane; and
 - (3) any dedicated parameters related to novel or unique design or operational characteristics of the aeroplane as determined by the Agency.
- (c) The parameters to be recorded should meet the performance specifications (range, sampling intervals, accuracy limits and resolution in read-out) as defined in the relevant tables of EUROCAE Document 112A, or any later equivalent standard produced by EUROCAE.

Table 1: FDR — All aeroplanes

No*	Parameter
1a	Time; or
1b	Relative time count
1c	Global navigation satellite system (GNSS) time synchronisation
2	Pressure altitude (including altitude values displayed on each flight crew member's primary flight display)

No*	Parameter
3	Indicated airspeed or calibrated airspeed (including values of indicated airspeed or calibrated airspeed displayed on each flight crew member's primary flight display)
4	Heading (primary flight crew reference) — when true or magnetic heading can be selected as the primary heading reference, a discrete indicating selection should be recorded.
5	Normal acceleration
6	Pitch attitude — pitch attitude values displayed on each flight crew member's primary flight display should be recorded, unless the aeroplane is type certified before 1 January 2023 and recording the values displayed at the captain position or the first officer position would require extensive modification.
7	Roll attitude — roll attitude values displayed on each flight crew member's primary flight display should be recorded, unless the aeroplane is type certified before 1 January 2023 and recording the values displayed at the captain position or the first officer position would require extensive modification.
8	Manual radio transmission keying and CVR/FDR synchronisation reference
9	Engine thrust/power:
9a	Parameters required to determine propulsive thrust/power on each engine, in both normal and reverse thrust
9b	Flight crew compartment thrust/power lever position (for aeroplanes with non-mechanically linked engine controls in the flight crew compartment)
14	Total or outside air temperature
16	Longitudinal acceleration (body axis)
17	Lateral acceleration
18	Primary flight control surface and/or primary flight control pilot input (For aeroplanes with control systems in which the movement of a control surface will back drive the pilot's control, 'or' applies. For aeroplanes with control systems in which the movement of a control surface will not back drive the pilot's control, 'and' applies. For multiple or split surfaces, a suitable combination of inputs is acceptable in lieu of recording each surface separately. For aeroplanes that have a flight control break-away capability that allows either pilot to operate the controls independently, record both inputs):
18a	Pitch axis
18b	Roll axis
18c	Yaw axis
19	Pitch trim surface position
23	Marker beacon passage

No*	Parameter
24	Warnings — In addition to the master warning, each 'red' warning that cannot be determined from other parameters or from the CVR and each smoke warning from other compartments should be recorded.
25	Each navigation receiver frequency selection
27	Air-ground status. Air-ground status and a sensor of each landing gear if installed

* The number in the left-hand column reflects the serial number depicted in EUROCAE Document 112A.

Table 2: FDR — Aeroplanes for which the data source for the parameter is either used by the aeroplane systems or is available on the instrument panel for use by the flight crew to operate the aeroplane

No*	Parameter
10	Flaps:
10a	Trailing edge flap position
10b	Flight crew compartment control selection
11	Slats:
11a	Leading edge flap (slat) position
11b	Flight crew compartment control selection
12	Thrust reverse status
13	Ground spoiler and speed brake:
13a	Ground spoiler position
13b	Ground spoiler selection
13c	Speed brake position
13d	Speed brake selection
15	Autopilot, autothrottle and automatic flight control system (AFCS): mode and engagement status (showing which systems are engaged and which primary modes are controlling the flight path and speed of the aircraft)
20	Radio altitude. For auto-land/category III operations, each radio altimeter should be recorded.
21	Vertical deviation — the approach aid in use should be recorded. For auto-land/category III operations, each system should be recorded:
21a	ILS/GPS/GLS glide path

No*	Parameter
21b	MLS elevation
21c	Integrated approach navigation (IAN) /Integrated Area Navigation (IRNAV), vertical deviation
22	Horizontal deviation — the approach aid in use should be recorded. For auto-land/category III operations, each system should be recorded:
22a	ILS/GPS/GLS localiser
22b	MLS azimuth
22c	GNSS approach path/IRNAV lateral deviation
26	Distance measuring equipment (DME) 1 and 2 distances:
26a	Distance to runway threshold (GLS)
26b	Distance to missed approach point (IRNAV/IAN)
28	Ground proximity warning system (GPWS)/terrain awareness warning system (TAWS)/ground collision avoidance system (GCAS) status — a suitable combination of discrettes unless recorder capacity is limited in which case a single discrete for all modes is acceptable:
28a	Selection of terrain display mode, including pop-up display status
28b	Terrain alerts, including cautions and warnings and advisories
28c	On/off switch position
29	Angle of attack
30	Low pressure warning (each system):
30a	Hydraulic pressure
30b	Pneumatic pressure
31	Ground speed
32	Landing gear:
32a	Landing gear position
32b	Gear selector position
33	Navigation data:
33a	Drift angle
33b	Wind speed
33c	Wind direction
33d	Latitude
33e	Longitude
33f	GNSS augmentation in use

No*	Parameter
34	Brakes:
34a	Left and right brake pressure
34b	Left and right brake pedal position
35	Additional engine parameters (if not already recorded in parameter 9 of Table 1, and if the aeroplane is equipped with a suitable data source):
35a	Engine pressure ratio (EPR)
35b	N1
35c	Indicated vibration level
35d	N2
35e	Exhaust gas temperature (EGT)
35f	Fuel flow
35g	Fuel cut-off lever position
35h	N3
35i	Engine fuel metering valve position (or equivalent parameter from the system that directly controls the flow of fuel into the engine) – for aeroplanes type certified before 1 January 2023, to be recorded only if this does not require extensive modification.
36	Traffic alert and collision avoidance system (TCAS)/airborne collision avoidance system (ACAS) — a suitable combination of discrettes should be recorded to determine the status of the system:
36a	Combined control
36b	Vertical control
36c	Up advisory
36d	Down advisory
36e	Sensitivity level
37	Wind shear warning
38	Selected barometric setting — to be recorded for the aeroplane where the parameter is displayed electronically:
38a	Pilot selected barometric setting
38b	Co-pilot selected barometric setting
39	Selected altitude (all pilot selectable modes of operation) — to be recorded for the aeroplane where the parameter is displayed electronically
40	Selected speed (all pilot selectable modes of operation) — to be recorded for the aeroplane where the parameter is displayed electronically
41	Selected Mach (all pilot selectable modes of operation) — to be recorded for the aeroplane

No*	Parameter
	where the parameter is displayed electronically
42	Selected vertical speed (all pilot selectable modes of operation) — to be recorded for the aeroplane where the parameter is displayed electronically
43	Selected heading (all pilot selectable modes of operation) — to be recorded for the aeroplane where the parameter is displayed electronically
44	Selected flight path (all pilot selectable modes of operation) — to be recorded for the aeroplane where the parameter is displayed electronically:
44a	Course/desired track (DSTRK)
44b	Path angle
44c	Coordinates of final approach path (IRNAV/IAN)
45	Selected decision height — to be recorded for the aeroplane where the parameter is displayed electronically
46	Electronic flight instrument system (EFIS) display format, showing the display system status:
46a	Pilot
46b	Co-pilot
47	Multi-function/engine/alerts display format, showing the display system status
48	Alternating current (AC) electrical bus status — each bus
49	Direct current (DC) electrical bus status — each bus
50	Engine bleed valve(s) position
51	Auxiliary power unit (APU) bleed valve(s) position
52	Computer failure — all critical flight and engine control systems
53	Engine thrust command
54	Engine thrust target
55	Computed centre of gravity (CG)
56	Fuel quantity in CG trim tank
57	Head-up display in use
58	Paravirtual display on
59	Operational stall protection, stick shaker and pusher activation
60	Primary navigation system reference:

No*	Parameter
60a	GNSS
60b	Inertial navigational system (INS)
60c	VHF omnidirectional radio range (VOR)/distance measuring equipment (DME)
60d	MLS
60e	Loran C
60f	ILS
61	Ice detection
62	Engine warning — each engine vibration
63	Engine warning — each engine over temperature
64	Engine warning — each engine oil pressure low
65	Engine warning — each engine overspeed
66	Yaw trim surface position
67	Roll trim surface position
68	Yaw or sideslip angle
69	De-icing and/or anti-icing systems selection
70	Hydraulic pressure — each system
71	Loss of cabin pressure
72	Trim control input position in the flight crew compartment, pitch — when mechanical means for control inputs are not available, displayed trim position or trim command should be recorded.
73	Trim control input position in the flight crew compartment, roll — when mechanical means for control inputs are not available, displayed trim position or trim command should be recorded.
74	Trim control input position in the flight crew compartment, yaw — when mechanical means for control inputs are not available, displayed trim position or trim command should be recorded.
75	All flight control input forces (for fly-by-wire flight control systems, where control surface position is a function of the displacement of the control input device only, it is not necessary to record this parameter):
75a	Control wheel input forces
75b	Control column input forces
75c	Rudder pedal input forces

No*	Parameter
76	Event marker
77	Date
78	Actual navigation performance (ANP) or estimate of position error (EPE) or estimate of position uncertainty (EPU)
79	Cabin pressure altitude – for aeroplanes type certified before 1 January 2023, to be recorded only if this does not require extensive modification
80	Aeroplane computed weight – for aeroplanes type certified before 1 January 2023, to be recorded only if this does not require extensive modification
81	Flight director command:
81a	Left flight director pitch command – for aeroplanes type certified before 1 January 2023, to be recorded only if this does not require extensive modification
81b	Left flight director roll command – for aeroplanes type certified before 1 January 2023, to be recorded only if this does not require extensive modification
81c	Right flight director pitch command – for aeroplanes type certified before 1 January 2023, to be recorded only if this does not require extensive modification
81d	Right flight director roll command – for aeroplanes type certified before 1 January 2023, to be recorded only if this does not require extensive modification
82	Vertical speed – for aeroplanes type certified before 1 January 2023, to be recorded only if this does not require extensive modification

* The number in the left-hand column reflects the serial number depicted in EUROCAE Document 112A.

AMC2 CAT.IDE.A.190 Flight data recorder

OPERATIONAL PERFORMANCE REQUIREMENTS FOR AEROPLANES FIRST ISSUED WITH AN INDIVIDUAL COFA ON OR AFTER 1 APRIL 1998 AND BEFORE 1 JANUARY 2016

- (a) The operational performance requirements for FDRs should be those laid down in EUROCAE Document ED-55 (Minimum Operational Performance Requirements For Flight Data Recorder Systems) dated May 1990, or EUROCAE Document ED-112 (Minimum Operational Performance Specification for Crash Protected Airborne Recorder Systems) dated March 2003, including amendments No 1 and No², or any later equivalent standard produced by EUROCAE.
- (b) The FDR should record, with reference to a timescale:
- (1) the parameters listed in Table 1a or Table 1b below, as applicable;
 - (2) the additional parameters listed in Table 2 below, for those aeroplanes with an MCTOM exceeding 27 000 kg;
 - (3) any dedicated parameters relating to novel or unique design or operational characteristics of the aeroplane as determined by the competent authority; and

- (4) the additional parameters listed in Table 3 below, for those aeroplanes equipped with electronic display systems.
- (c) When determined by the Agency, the FDR of aeroplanes first issued with an individual CofA before 20 August 2002 and equipped with an electronic display system does not need to record those parameters listed in Table 3 for which:
- (1) the sensor is not available;
 - (2) the aeroplane system or equipment generating the data needs to be modified; or
 - (3) the signals are incompatible with the recording system;
- (d) The FDR of aeroplanes first issued with an individual CofA on or after 1 April 1998 but not later than 1 April 2001 is not required to comply with (b) above if:
- (1) compliance with (a) cannot be achieved without extensive modification to the aeroplane system and equipment other than the flight recording system; and
 - (2) the FDR of the aeroplane can comply with AMC4 CAT.IDE.A.190(a) except that parameter 15b in Table 1 of AMC4 CAT.IDE.A.190 need not be recorded.
- (e) The parameters to be recorded should meet, as far as practicable, the performance specifications (ranges, sampling intervals, accuracy limits, and resolution in read-out) defined in Table 1 of AMC3 CAT.IDE.A.190.
- (f) For aeroplanes with novel or unique design or operational characteristics, the additional parameters should be those required in accordance with applicable Certification Specifications during type or supplemental certification or validation.
- (g) If recording capacity is available, as many as possible of the additional parameters specified in table II-A.1 of EUROCAE Document ED 112 dated March 2003 should be recorded.

Table 1a

FDR — Aeroplanes with an MCTOM of more than 5 700 kg

No	Parameter
1	Time or relative time count
2	Pressure altitude
3	Indicated airspeed or calibrated airspeed
4	Heading
5	Normal acceleration
6	Pitch attitude
7	Roll attitude
8	Manual radio transmission keying
9	Propulsive thrust/power on each engine and flight crew compartment thrust/power lever position if applicable

No	Parameter
10	Trailing edge flap or flight crew compartment control selection
11	Leading edge flap or flight crew compartment control selection
12	Thrust reverse status
13	Ground spoiler position and/or speed brake selection
14	Total or outside air temperature
15	Autopilot, autothrottle and AFCS mode and engagement status
16	Longitudinal acceleration (body axis)
17	Lateral acceleration

Table 1b

FDR — Aeroplanes with an MCTOM 5 700 kg or below

No	Parameter
1	Time or relative time count
2	Pressure altitude
3	Indicated airspeed or calibrated airspeed
4	Heading
5	Normal acceleration
6	Pitch attitude
7	Roll attitude
8	Manual radio transmission keying
9	Propulsive thrust/power on each engine and flight crew compartment thrust/power lever position if applicable
10	Trailing edge flap or flight crew compartment control selection
11	Leading edge flap or flight crew compartment control selection
12	Thrust reverse status
13	Ground spoiler position and/or speed brake selection

No	Parameter
14	Total or outside air temperature
15	Autopilot/autothrottle engagement status
16	Longitudinal acceleration (body axis)
17	Angle of attack (if a suitable sensor is available)

Table 2

FDR — Additional parameters for aeroplanes with an MCTOM of more than 27 000 kg

No	Parameter
18	Primary flight controls — control surface position and/or pilot input (pitch, roll, yaw)
19	Pitch trim position
20	Radio altitude
21	Vertical beam deviation (ILS glide path or MLS elevation)
22	Horizontal beam deviation (ILS localiser or MLS azimuth)
23	Marker beacon passage
24	Warnings
25	Reserved (navigation receiver frequency selection is recommended)
26	Reserved (DME distance is recommended)
27	Landing gear squat switch status or air/ground status
28	Ground proximity warning system
29	Angle of attack
30	Low pressure warning (hydraulic and pneumatic power)
31	Groundspeed
32	Landing gear or gear selector position

Table 3

FDR — Aeroplanes equipped with electronic display systems

No	Parameter
33	Selected barometric setting (each pilot station)
34	Selected altitude
35	Selected speed
36	Selected Mach
37	Selected vertical speed
38	Selected heading
39	Selected flight path
40	Selected decision height
41	EFIS display format
42	Multi-function/engine/alerts display format

AMC3 CAT.IDE.A.190 Flight data recorder

PERFORMANCE SPECIFICATIONS FOR THE PARAMETERS TO BE RECORDED FOR AEROPLANES FIRST ISSUED WITH AN INDIVIDUAL COFA ON OR AFTER 1 APRIL 1998 AND BEFORE 1 JANUARY 2016

Table 1: FDR

No	Parameter	Range	Sampling interval in seconds	Accuracy limits (sensor input compared to FDR readout)	Recommended resolution in readout	Remarks
1a or	Time	24 hours	4	± 0.125 % per hour	1 second	(a) UTC time preferred where available.
1b	Relative time count	0 to 4 095	4	± 0.125 % per hour		(b) Counter increments every 4 seconds of system operation.
2	Pressure altitude	-1 000 ft to maximum certificated altitude of aircraft +5 000 ft	1	±100 ft to ±700 ft Refer to Table II-A.3 of EUROCAE Document ED-112	5 ft	Should be obtained from air data computer when installed.
3	Indicated airspeed or calibrated airspeed	50 kt or minimum value installed pitot static system to Max V_{S0} Max V_{S0} to 1.2 V_D	1	±5 % ±3 %	1 kt (0.5 kt recommended)	Should be obtained from air data computer when installed. V_{S0} : stalling speed or minimum steady flight speed in the landing configuration V_D design diving speed
4	Heading	360 degrees	1	±2 degrees	0.5 degrees	
5	Normal acceleration	-3 g to +6 g	0.125	1 % of maximum range excluding a datum error of 5 %	0.004 g	The recording resolution may be rounded from 0.004 g to 0.01 g provided that one sample is recorded at full resolution at least every 4 seconds.
6	Pitch attitude	±75 degrees	0.25	±2 degrees	0.5 degrees	
7	Roll attitude	±180 degrees	0.5	±2 degrees	0.5 degrees	

8	Manual radio transmission keying	Discrete	1	-	-	Preferably each crew member but one discrete acceptable for all transmissions provided that the replay of a recording made by any required recorder can be synchronised in time with any other required recording to within 1 second.
9a	Propulsive thrust/power on each engine	Full range	Each engine each second	$\pm 2\%$	0.2 % of full range	Sufficient parameters, e.g. EPR/N, or Torque/N _p as appropriate to the particular engine must be recorded to determine power in both normal and reverse thrust. A margin for possible overspeed should be provided.
9b	Flight crew compartment thrust/power lever position	Full range	Each lever each second	$\pm 2\%$ or sufficient to determine any gated position	2 % of full range	Parameter 9b must be recorded for aeroplanes with non-mechanically linked cockpit-engine controls, otherwise recommended.
10	Trailing edge flap or flight crew compartment control selection	Full range or each discrete position	2	$\pm 3^\circ$ or as pilot's indicator and sufficient to determine each discrete position	0.5 % of full range	Flap position and cockpit control may be sampled at 4-second intervals so as to give a data point each 2 seconds.
11	Leading edge flap or flight crew compartment control selection	Full range or each discrete position	1	$\pm 3^\circ$ or as pilot's indicator and sufficient to determine each discrete position	0.5 % of full range	Left and right sides, or flap position and cockpit control may be sampled at 2-second intervals so as to give a data point each second.
12	Thrust reverser status	Turbo-jet: stowed, in transit and reverse Turbo-prop: reverse	Each reverser each second	-	-	Turbo-jet: 2 discretely enable the 3 states to be determined Turbo-prop: 1 discrete

13	Ground spoiler and/or speed brake selection	Full range or each discrete position	0.5	±2° unless higher accuracy uniquely required	0.2 % of full range	Sufficient to determine use of the cockpit selector and the activation and positions of the surfaces
14	Outside air temperatures or total air temperature	-50°C to +90°C or available sensor range	2	±2°C	0.3°C	
15	Autopilot/Autothrottle /AFCS mode and engagement status	A suitable combination of discrettes	1	-	-	Discrettes should show which systems are engaged and which primary modes are controlling the flight path and speed of the aircraft.
16	Longitudinal acceleration (Body axis)	± 1 g	0.25	±1.5 % of maximum range excluding a datum error of ±5 %	0.004 g	The recording resolution may be rounded from 0.004 g to 0.01 g provided that one sample is recorded at full resolution at least every 4 seconds.
17	Lateral acceleration	±1 g	0.25	±1.5 % of maximum range excluding a datum error of ±5 %	0.004 g	The recording resolution may be rounded from 0.004 g to 0.01 g provided that one sample is recorded at full resolution at least every 4 seconds.
18	Primary flight controls, control surface positions and/or* pilot input	Full range	1	±2° unless higher accuracy uniquely required	0.2 % of full range	*For aeroplanes that can demonstrate the capability of deriving either the control input or control movement (one from the other) for all modes of operation and flight regimes, the 'or' applies. For aeroplanes with non-mechanical control systems, the
18a	Pitch axis		0.25			
18b	Roll axis		0.25			

18c	Yaw axis		0.5			<p>'and' applies.</p> <p>Where the input controls for each pilot can be operated independently, both inputs will need to be recorded.</p> <p>For multiple or split surfaces, a suitable combination of inputs is acceptable in lieu of recording each surface separately.</p>
19	Pitch trim position	Full range	1	±3 % unless higher accuracy uniquely required	0.3 % of full range	Where dual surfaces are provided it is permissible to record each surface alternately.
20	Radio altitude	-20 ft to +2 500 ft	1	As installed ±2 ft or ±3 % whichever is greater below 500 ft and ±5 % above 500 ft recommended.	1 ft below 500 ft, 1 ft +0.5 % of full range above 500 ft	For auto-land/category III operations, each radio altimeter should be recorded, but arranged so that at least one is recorded each second.
21	Vertical beam deviation		1	As installed ±3 % recommended	0.3 % of full range	Data from both the ILS and MLS systems need not to be recorded at the same time. The approach aid in use should be recorded. For auto-land/ category III operations, each radio altimeter should be recorded, but arranged so that at least one is recorded each second.
21a	ILS glide path	±0.22 DDM or available sensor range as installed				
21b	MLS elevation	0.9° to 30°				
22	Horizontal beam deviation	Signal range	1	As installed ±3 % recommended	0.3 % of full range	See parameter 21 remarks.
22a	ILS Localiser	±0.22 DDM or available sensor range as installed				
22b	MLS azimuth	±62°				

23	Marker beacon passage	Discrete	1	—	—	A single discrete is acceptable for all markers.
24	Warnings	Discretets	1	—	—	A discrete must be recorded for the master warning. Each ‘red’ warning (including lavatory smoke) should be recorded when the warning condition cannot be determined from other parameters or from the cockpit voice recorder.
25	Reserved	—	—	—	—	
26	Reserved	—	—	—	—	
27	Landing gear squat switch status	Discrete(s)	1 (0.25 recommended for main gears)	—	—	Discretets should be recorded for the nose and main landing gears.
28	Ground proximity warning system (GPWS)	Discrete	1	—	—	A suitable combination of discretets unless recorder capacity is limited in which case a single discrete for all modes is acceptable.
29	Angle of attack	As installed	0.5	As installed	0.3 % of full range	If left and right sensors are available, each may be recorded at 1-second intervals so as to give a data point each half second.
30	Low pressure warning	Discrete(s) or available sensor range	2	-	0.5 % of full range	Each essential system to be recorded.
30a	Hydraulic power					
30b	Pneumatic power					
31	Groundspeed	As installed	1	Data should be obtained from the most accurate system	1 kt	

32	Landing gear or gear selector position	Discrete(s)	4	-	-	A suitable combination of discrettes should be recorded.
33	Selected barometric setting (each pilot station)	As installed	64	As installed	1 mb	Where practicable, a sampling interval of 4 seconds is recommended
33a	Pilot					
33b	Co-pilot					
34	Selected altitude	As installed	1	As installed	100 ft	Where capacity is limited, a sampling interval of 64 seconds is permissible.
34a	Manual					
34b	Automatic					
35	Selected speed	As installed	1	As installed	1 kt	Where capacity is limited, a sampling interval of 64 seconds is permissible.
35a	Manual					
35b	Automatic					
36	Selected Mach	As installed	1	As installed	0.01	Where capacity is limited, a sampling interval of 64 seconds is permissible.
36a	Manual					
36b	Automatic					
37	Selected vertical speed	As installed	1	As installed	100 ft/min	Where capacity is limited, a sampling interval of 64 seconds is permissible.
37a	Manual					
37b	Automatic					
38	Selected heading	360 degrees	1	As installed	1 degree	Where capacity is limited ,a sampling interval of 64 seconds is permissible.
39	Selected flight path		1	As installed		Where capacity is limited, a sampling interval of 64 seconds is permissible.
39a	Course/DSTRK	360 degrees				
39b	Path Angle	As installed				

40	Selected decision height	0-500 ft	64	As installed	1 ft	
41	EFIS display format	Discrete(s)	4	–	–	Discretes should show the display system status e.g. off, normal, fail, composite, sector, plan, rose, nav aids, wxr, range, copy.
41a	Pilot					
41b	Co-pilot					
42	Multifunction/Engine/Alerts display format	Discrete(s)	4	–	–	Discretes should show the display system status e.g. off, normal, fail, and the identity of display pages for emergency procedures and checklists. Information in checklists and procedures need not be recorded.

AMC4 CAT.IDE.A.190 Flight data recorder

LIST OF PARAMETERS TO BE RECORDED FOR AEROPLANES FIRST ISSUED WITH AN INDIVIDUAL COFA ON OR AFTER 1 JUNE 1990 UP TO AND INCLUDING 31 MARCH 1998

- (a) The FDR should, with reference to a timescale, record:
- (1) the parameters listed in Table 1 below; and
 - (2) the additional parameters listed in Table 2 below for those aeroplanes with an MCTOM exceeding 27 000 kg.
- (b) When determined by the Agency, the FDR of aeroplanes having an MCTOM of 27 000 kg or below does not need to record parameters 14 and 15b of Table 1 below if any of the following conditions are met:
- (1) the sensor is not readily available;
 - (2) sufficient capacity is not available in the flight recorder system; or
 - (3) a change is required in the equipment that generates the data.
- (c) When determined by the Agency, the FDR of aeroplanes having an MCTOM exceeding 27 000 kg does not need to record parameter 15b of Table 1 below, and parameters 23, 24, 25, 26, 27, 28, 29, 30 and 31 of Table 2 below, if any of the following conditions are met:
- (1) the sensor is not readily available;
 - (2) sufficient capacity is not available in the FDR system;
 - (3) a change is required in the equipment that generates the data; or
 - (4) for navigational data (NAV frequency selection, DME distance, latitude, longitude, ground speed and drift), the signals are not available in digital form.
- (d) When determined by the Agency, the FDR does not need to record individual parameters that can be derived by calculation from the other recorded parameters.
- (e) The parameters to be recorded should meet, as far as practicable, the performance specifications (range, sampling intervals, accuracy limits, and resolution in read-out) defined in Table 1 of AMC5 CAT.IDE.A.190.

Table 1

Flight data recorder — Aeroplanes with an MCTOM of more than 5 700 kg

No	Parameter
1	Time or relative time count
2	Pressure altitude
3	Indicated airspeed or calibrated airspeed
4	Heading
5	Normal acceleration
6	Pitch attitude

No	Parameter
7	Roll attitude
8	Manual radio transmission keying unless an alternate means to synchronise FDR and CVR recordings is provided
9	Power on each engine
10	Trailing edge flap or flight crew compartment control selection
11	Leading edge flap or flight crew compartment control selection
12	Thrust reverse position (for turbojet aeroplanes only)
13	Ground spoiler position and/or speed brake selection
14	Outside air temperature or total air temperature
15a	Autopilot engagement status
15b	Autopilot operating modes, autothrottle and AFCS systems engagement status and operating modes.

Table 2

Flight data recorder — Additional parameters for aeroplanes with an MCTOM of more than 27 000 kg

No	Parameter
16	Longitudinal acceleration
17	Lateral acceleration
18	Primary flight controls — control surface position and/or pilot input (pitch, roll and yaw)
19	Pitch trim position
20	Radio altitude
21	Glide path deviation
22	Localiser deviation
23	Marker beacon passage
24	Master warning
25	NAV 1 and NAV 2 frequency selection
26	DME 1 and DME 2 distance

No	Parameter
27	Landing gear squat switch status
28	Ground proximity warning system (GPWS)
29	Angle of attack
30	Hydraulics, each system (low pressure)
31	Navigation data
32	Landing gear or gear selector position

AMC5 CAT.IDE.A.190 Flight data recorder

PERFORMANCE SPECIFICATIONS FOR THE PARAMETERS TO BE RECORDED FOR AEROPLANES FIRST ISSUED WITH AN INDIVIDUAL COFA UP TO AND INCLUDING 31 MARCH 1998

Table 1: Flight data recorder

No	Parameter	Range	Sampling interval in seconds	Accuracy limits (sensor input compared to FDR readout)	Recommended resolution in readout	Remarks
1	Time or relative time count	24 hours	4	±0.125 % per hour	1 second	Coordinated universal time (UTC) preferred where available, otherwise elapsed time
2	Pressure altitude	-1 000 ft to maximum certificated altitude of aircraft +5 000 ft	1	±100 ft to ±700 ft	5 ft	For altitude record error see EASA ETSO-C124a
3	Indicated airspeed or calibrated airspeed	50 kt to max V_{S0} Max V_{S0} to $1.2 V_D$	1	±5 % ±3 %	1 kt	V_{S0} stalling speed or minimum steady flight speed in the landing configuration V_D design diving speed
4	Heading	360 degrees	1	±2 degrees	0.5 degrees	
5	Normal acceleration	-3 g to +6 g	0.125 ±	±1 % of maximum range excluding a datum error of ±5 %	0.004 g	
6	Pitch attitude	±75 degrees	1	±2 degrees	0.5 degrees	
7	Roll attitude	±180 degrees	1	±2 degrees	0.5 degrees	
8	Manual radio transmission keying	Discrete	1	-	-	On-off (one discrete). An FDR/CVR time synchronisation signal complying with 4.2.1 of EUROCAE ED-55 is considered to be an acceptable alternative means of

No	Parameter	Range	Sampling interval in seconds	Accuracy limits (sensor input compared to FDR readout)	Recommended resolution in readout	Remarks
						compliance.
9	Power on each engine	Full range	Each engine each second	±2 %	0.2 % of full range	Sufficient parameters e.g. EPR/N, or Torque/N _P as appropriate to the particular engine should be recorded to determine power.
10	Trailing edge flap or flight crew compartment control selection	Full range or each discrete position	2	±5 % or as pilot's indicator	0.5 % of full range	
11	Leading edge flap or flight crew compartment control selection	Full range or each discrete position	2	-	0.5 % of full range	
12	Thrust reverser position	Stowed, in transit and reverse	Each reverser each second	±2 % unless higher accuracy uniquely required	-	
13	Ground spoiler and/or speed brake selection	Full range or each discrete position	1	±2 degrees	0.2 % of full range	
14	Outside air temperatures or total air temperature	Sensor range	2	-	0.3°C	
15a	Autopilot engagement status					
15b	Autopilot operating modes, auto-throttle and AFCS systems	A suitable combination of discretes	1		-	

No	Parameter	Range	Sampling interval in seconds	Accuracy limits (sensor input compared to FDR readout)	Recommended resolution in readout	Remarks
	engagement status and operating modes					
16	Longitudinal acceleration	± 1 g	0.25	±1.5 % of maximum range excluding a datum error of ±5 %	0.004 g	
17	Lateral acceleration	±1 g	0.25	±1.5 % of maximum range excluding a datum error of ±5 %	0.004 g	
18	Primary flight controls, control surface positions and/or pilot input (pitch, roll, yaw)	Full range	1	±2 degrees unless higher accuracy uniquely required	0.2 % of full range	For aeroplanes with conventional control systems, 'or' applies. For aeroplanes with non-mechanical control systems, 'and' applies. For aeroplanes with split surfaces, a suitable combination of inputs is acceptable in lieu of recording each surface separately.
19	Pitch trim position	Full range	1	±3 % unless higher accuracy uniquely required	0.3 % of full range	
20	Radio altitude	-20 ft to +2 500 ft	1	±2 ft or ±3 % whichever is greater below 500 ft and ±5 % above 500 ft	1 ft below 500 ft, 1 ft +5 % of full range above 500 ft	As installed. Accuracy limits are recommended
21	Glide path deviation	Signal range	1	±3 %	0.3 % of full range	As installed. Accuracy limits are recommended
22	Localiser deviation	Signal range	1	±3 %	0.3 % of full range	As installed. Accuracy limits are recommended.
23	Marker beacon passage	Discrete	1	–	–	A single discrete is acceptable for all markers.

No	Parameter	Range	Sampling interval in seconds	Accuracy limits (sensor input compared to FDR readout)	Recommended resolution in readout	Remarks
24	Master warning	Discrete	1	–	–	
25	NAV 1 and 2 frequency selection	Full range	4	As installed	–	
26	DME 1 and 2 distance	0-200 NM	4	As installed	–	Recording of latitude and longitude from INS or other navigation system is a preferred alternative.
27	Landing gear squat switch status	Discrete	1	–	–	
28	Ground proximity warning system (GPWS)	Discrete	1	–	–	
29	Angle of attack	Full range	0.5	As installed	0.3 % of full range	
30	Hydraulics	Discrete(s)	2	–	–	
31	Navigation data	As installed	1	As installed	–	
32	Landing gear or gear selector position	Discrete	4	As installed	–	

* The number in the left hand column reflects the serial number depicted in EUROCAE Document ED-112.

AMC6 CAT.IDE.A.190 Flight data recorder**LIST OF PARAMETERS TO BE RECORDED FOR AEROPLANES FIRST ISSUED WITH AN INDIVIDUAL COFA BEFORE 1 JUNE 1990**

- (a) The FDR should, with reference to a timescale, record:
- (1) the parameters listed in Table 1 below;
 - (2) the additional parameters 6 to 15b of Table 2 below, for aeroplanes with an MCTOM exceeding 5 700 kg but not exceeding 27 000 kg and first issued with an individual CofA on or after 1 January 1989, when the following conditions are met:
 - (i) sufficient capacity is available on a flight recorder system;
 - (ii) the sensor is readily available; and
 - (iii) a change is not required in the equipment that generates the data;
 - (3) the additional parameters from 6 to 15b of Table 2 below, for aeroplanes with a maximum certificated take-off mass exceeding 27 000 kg that are of a type first type certified after 30 September 1969; and
 - (4) the additional parameters listed in Table 2 below for aeroplanes with an MCTOM exceeding 27 000 kg and first issued with an individual CofA on or after 1 January 1987, when the following conditions are met:
 - (i) sufficient capacity is available on a flight recorder system;
 - (ii) the sensor is readily available; and
 - (iii) a change is not required in the equipment that generates the data.
- (b) When determined by the Agency, the FDR of aeroplanes with an MCTOM exceeding 27 000 kg that are of a type first type certified after 30 September 1969 does not need to record the parameters 13, 14 and 15b in Table 2 below, when any of the following conditions are met:
- (1) sufficient capacity is not available on a flight recorder system;
 - (2) the sensor is not readily available; and
 - (3) a change is required in the equipment that generates the data.
- (c) The parameters to be recorded should meet, as far as practicable, the performance specifications (range, sampling intervals, accuracy limits, and resolution in read-out) defined in Table 1 of AMC5 CAT.IDE.A.190).
- (d) When so determined by the Agency, the FDR does not need to record individual parameters that can be derived by calculation from the other recorded parameters.

Table 1

Flight data recorder — aeroplanes with an MCTOM exceeding 5 700 kg

No	Parameter
1	Time or relative time count
2	Pressure altitude
3	Indicated airspeed or calibrated airspeed

No	Parameter
4	Heading
5	Normal acceleration

* The number in the left hand column reflects the serial number depicted in EUROCAE Document ED-112.

Table 2

Additional parameters for aeroplanes under conditions of AMC6 CAT.IDE.A.190, 1 & 2

No	Parameter
6	Pitch attitude
7	Roll attitude
8	Manual radio transmission keying unless an alternate means to synchronise the FDR and CVR recordings is provided
9	Power on each engine
10	Trailing edge flap or flight crew compartment control selection
11	Leading edge flap or flight crew compartment control selection
12	Thrust reverse position (for turbojet aeroplanes only)
13	Ground spoiler position and/or speed brake selection
14	Outside air temperature (OAT) or total air temperature
15a	Autopilot engagement status
15b	Autopilot operating modes, autothrottle and AFCS, systems engagement status and operating modes.
16	Longitudinal acceleration
17	Lateral acceleration
18	Primary flight controls — control surface position and/or pilot input (pitch, roll and yaw)
19	Pitch trim position
20	Radio altitude
21	Glide path deviation
22	Localiser deviation

No	Parameter
23	Marker beacon passage
24	Master warning
25	NAV 1 and NAV 2 frequency selection
26	DME 1 and DME 2 distance
27	Landing gear squat switch status
28	Ground proximity warning system (GPWS)
29	Angle of attack
30	Hydraulics, each system (low pressure)
31	Navigation data (latitude, longitude, ground speed and drift angle)
32	Landing gear or gear selector position

* The number in the left hand column reflects the serial number depicted in EUROCAE Document ED-112.

GM1 CAT.IDE.A.190 Flight data recorder

GENERAL

- (a) The alleviation of AMC2 CAT.IDE.A.190(d) affects a small number of aeroplanes first issued with an individual CofA on or after 1 April 1998 that were either constructed prior to this date or to a specification in force just prior to this date. These aeroplanes may not comply fully with AMC2 CAT.IDE.A.190(b), but are able to comply with AMC4 CAT.IDE.A.190. In addition, this alleviation applies only if compliance with AMC2 CAT.IDE.A.190(b) would imply significant modifications to the aeroplane with a severe re-certification effort.
- (b) Flight data recorder systems installed on board aeroplanes first issued with an individual CofA up to and including 31 March 1998, and for which the recorded parameters do not comply with the performance specifications of Table 1 of AMC5 CAT.IDE.A.190 (i.e. range, sampling intervals, accuracy limits and recommended resolution readout) may be acceptable to the Agency.
- (c) The alleviations of AMC4 CAT.IDE.A.190(b) and (c), and AMC6 CAT.IDE.A.190(b), are acceptable only if adding the recording of missing parameters to the existing flight data recorder system would require a major upgrade of the system itself. Account is taken of the following:
- (1) The extent of the modification required;
 - (2) The downtime period; and
 - (3) Equipment software development.
- (d) For the purpose of AMC4 CAT.IDE.A.190(b) and (c), and AMC6 CAT.IDE.A.190(a) and (b), 'capacity available' refers to the space on both the flight data acquisition unit and the flight data recorder not allocated for recording the required parameters, or the parameters recorded for the purpose of the Flight Data Monitoring programme, as determined by the Agency.

-
- (e) For the purpose of AMC4 CAT.IDE.A.190(b) and (c), and AMC6 CAT.IDE.A.190(a) and (b), a sensor is considered 'readily available' when it is already available or can be easily incorporated.
- (f) For aeroplanes first issued with an individual CofA up to and including 31 March 1998, the recording of the following additional parameters may be considered:
- (1) Remaining parameters in Table 2 of AMC4 CAT.IDE.A.190 or Table 2 of AMC6 CAT.IDE.A.190 as applicable;
 - (2) Any dedicated parameter relating to novel or unique design or operational characteristics of the aeroplane;
 - (3) operational information from electronic display systems, such as EFIS, ECAM or EICAS, with the following order of priority:
 - (i) parameters selected by the flight crew relating to the desired flight path, e.g. barometric pressure setting, selected altitude, selected airspeed, decision height, and autoflight system engagement and mode indications if not recorded from another source;
 - (ii) display system selection/status, e.g. SECTOR, PLAN, ROSE, NAV, WXR, COMPOSITE, COPY, etc.;
 - (iii) warning and alerts;
 - (iv) the identity of displayed pages from emergency procedures and checklists.
 - (4) retardation information including brake application for use in the investigation of landing overruns or rejected take offs; and
 - (5) additional engine parameters (EPR, N1, EGT, fuel flow, etc.).

CAT.IDE.A.195 Data link recording

- (a) Aeroplanes first issued with an individual CofA on or after 8 April 2014 that have the capability to operate data link communications and are required to be equipped with a CVR, shall record on a recorder, where applicable:
- (1) data link communication messages related to ATS communications to and from the aeroplane, including messages applying to the following applications:
 - (i) data link initiation;
 - (ii) controller-pilot communication;
 - (iii) addressed surveillance;
 - (iv) flight information;
 - (v) as far as is practicable, given the architecture of the system, aircraft broadcast surveillance;
 - (vi) as far as is practicable, given the architecture of the system, aircraft operational control data; and
 - (vii) as far as is practicable, given the architecture of the system, graphics;
 - (2) information that enables correlation to any associated records related to data link communications and stored separately from the aeroplane; and
 - (3) information on the time and priority of data link communications messages, taking into account the system's architecture.
- (b) The recorder shall use a digital method of recording and storing data and information and a method for retrieving that data. The recording method shall allow the data to match the data recorded on the ground.
- (c) The recorder shall be capable of retaining data recorded for at least the same duration as set out for CVRs in CAT.IDE.A.185.
- (d) If the recorder is not deployable, it shall have a device to assist in locating it under water. By 16 June 2018 at the latest, this device shall have a minimum underwater transmission time of 90 days. If the recorder is deployable, it shall have an automatic emergency locator transmitter.
- (e) The requirements applicable to the start and stop logic of the recorder are the same as the requirements applicable to the start and stop logic of the CVR contained in CAT.IDE.A.185(d) and (e).

AMC1 CAT.IDE.A.195 Data link recording

GENERAL

- (a) As a means of compliance with CAT.IDE.A.195(a), the recorder on which the data link messages is recorded may be:
- (1) the CVR;
 - (2) the FDR;
 - (3) a combination recorder when CAT.IDE.A.200 is applicable; or
 - (4) a dedicated flight recorder. In that case, the operational performance requirements for this recorder should be those laid down in EUROCAE Document ED-112 (Minimum Operational Performance Specification for Crash Protected Airborne Recorder Systems) dated March

2003, including amendments No 1 and No 2, or any later equivalent standard produced by EUROCAE.

- (b) As a means of compliance with CAT.IDE.A.195(a)(2), the operator should enable correlation by providing information that allows an accident investigator to understand what data was provided to the aeroplane and, when the provider identification is contained in the message, by which provider.
- (c) The timing information associated with the data link communications messages required to be recorded by CAT.IDE.A.195(a)(3) should be capable of being determined from the airborne-based recordings. This timing information should include at least the following:
- (1) the time each message was generated;
 - (2) the time any message was available to be displayed by the crew;
 - (3) the time each message was actually displayed or recalled from a queue; and
 - (4) the time of each status change.
- (d) The message priority should be recorded when it is defined by the protocol of the data link communication message being recorded.
- (e) The expression ‘taking into account the system architecture’, in CAT.IDE.A.195(a)(3), means that the recording of the specified information may be omitted if the existing source systems involved would require a major upgrade. The following should be considered:
- (1) the extent of the modification required;
 - (2) the down-time period; and
 - (3) equipment software development.
- The intention is that new designs of source systems should include this functionality and support the full recording of the required information.
- (f) Data link communications messages that support the applications in Table 1 below should be recorded.
- (g) Further details on the recording requirements can be found in the recording requirement matrix in Appendix D.2 of EUROCAE Document ED-93 (Minimum Aviation System Performance Specification for CNS/ATM Recorder Systems, dated November 1998).

Table 1

Applications

Item No	Application Type	Application Description	Required Recording Content
1	Data link initiation	This includes any application used to log on to, or initiate, a data link service. In future air navigation system (FANS)-1/A and air traffic navigation (ATN), these are ATS facilities notification (AFN) and context management (CM) respectively.	C
2	Controller/pilot communication	This includes any application used to exchange requests, clearances, instructions and reports between the flight crew and air traffic controllers. In FANS-1/A and ATN, this includes the controller pilot data link communications (CPDLC) application. It also includes applications used for the exchange of oceanic	C

		(OCL) and departure clearances (DCL) as well as data link delivery of taxi clearances.	
3	Addressed surveillance	This includes any surveillance application in which the ground sets up contracts for delivery of surveillance data. In FANS-1/A and ATN, this includes the automatic dependent surveillance-contract (ADS-C) application.	C, F2
4	Flight information	This includes any application used for delivery of flight information data to specific aeroplanes. This includes for example, digital automatic terminal information service (D-ATIS), data link operational terminal information service (D-OTIS), digital weather information services (D-METAR or TWIP), data link flight information service (D-FIS), and Notice to Airmen (electronic NOTAM) delivery.	C
5	Aircraft broadcast surveillance	This includes elementary and enhanced surveillance systems, as well as automatic dependent surveillance-broadcast (ADS-B) output data.	M*, F2
6	Aeronautical operational control (AOC) data	This includes any application transmitting or receiving data used for AOC purposes (in accordance with the ICAO definition of AOC). Such systems may also process AAC messages, but there is no requirement to record AAC messages.	M*
7	Graphics	This includes any application receiving graphical data to be used for operational purposes (i.e. excluding applications that are receiving such things as updates to manuals).	M* F1

GM1 CAT.IDE.A.195 Data link recording

DEFINITIONS AND ACRONYMS

(a) The letters and expressions in Table 1 of AMC1 CAT.IDE.A.195 have the following meaning:

C: complete contents recorded

M: information that enables correlation with any associated records stored separately from the aeroplane.

*: Applications that are to be recorded only as far as is practicable, given the architecture of the system.

F1: graphics applications may be considered as AOC messages when they are part of a data link communications application service run on an individual basis by the operator itself in the framework of the operational control.

F2: where parametric data sent by the aeroplane, such as Mode S, is reported within the message, it should be recorded unless data from the same source is recorded on the FDR.

(b) The definitions of the applications type in Table 1 of AMC1 CAT.IDE.A.195 are described in Table 1 below.

Table 1

Definitions of applications type

Item No	Application Type	Messages	Comments
1	CM		CM is an ATN service
2	AFN		AFN is a FANS 1/A service
3	CPDLC		All implemented up and downlink messages to be recorded
4	ADS-C	ADS-C reports	All contract requests and reports recorded
		Position reports	Only used within FANS 1/A. Only used in oceanic and remote areas.
5	ADS-B	Surveillance data	Information that enables correlation with any associated records stored separately from the aeroplane.
6	D-FIS		D-FIS is an ATN service. All implemented up and downlink messages to be recorded
7	TWIP	TWIP messages	Terminal weather information for pilots
8	D-ATIS	ATIS messages	Refer to EUROCAE Document ED-89A dated December 2003. Data Link Application System Document (DLASD) for the 'ATIS' Data Link Service
9	OCL	OCL messages	Refer to EUROCAE Document ED-106A dated March 2004. Data Link Application System Document (DLASD) for 'Oceanic Clearance' Data Link Service
10	DCL	DCL messages	Refer to EUROCAE Document ED-85A dated December 2003. Data Link Application System Document (DLASD) for 'Departure Clearance' Data Link Service
11	Graphics	Weather maps & other graphics	Graphics exchanged in the framework of procedures within the operational control, as specified in Part-ORO. Information that enables correlation with any associated records stored separately from the aeroplane.
12	AOC	Aeronautical operational control messages	Messages exchanged in the framework of procedures within the operational control, as specified in Part-ORO. Information that enables correlation with any associated records stored separately from the aeroplane. Definition in EUROCAE Document ED-112, dated March 2003.
13	Surveillance	Downlinked aircraft parameters (DAP)	As defined in ICAO Annex 10 Volume IV (Surveillance systems and ACAS).

AAC	aeronautical administrative communications
ADS-B	automatic dependent surveillance — broadcast
ADS-C	automatic dependent surveillance — contract
AFN	aircraft flight notification

AOC	aeronautical operational control
ATIS	automatic terminal information service
ATSC	air traffic service communication
CAP	controller access parameters
CPDLC	controller pilot data link communications
CM	configuration/context management
D-ATIS	digital ATIS
D-FIS	data link flight information service
D-METAR	data link meteorological airport report
DCL	departure clearance
FANS	Future Air Navigation System
FLIPCY	flight plan consistency
OCL	oceanic clearance
SAP	system access parameters
TWIP	terminal weather information for pilots

GM1 CAT.IDE.A.195(a) Data link recording

APPLICABILITY OF THE DATA LINK RECORDING REQUIREMENT

- (a) If it is certain that the aeroplane cannot use data link communication messages for ATS communications corresponding to any application designated by CAT.IDE.A.195(a)(1), then the data link recording requirement does not apply.
- (b) Examples where the aeroplane cannot use data link communication messages for ATS communications include but are not limited to the cases where:
 - (1) the aeroplane data link communication capability is disabled permanently and in a way that it cannot be enabled again during the flight;
 - (2) data link communications are not used to support air traffic service (ATS) in the area of operation of the aeroplane; and
 - (3) the aeroplane's data link communication equipment cannot communicate with the equipment used by ATS in the area of operation of the aeroplane.

CAT.IDE.A.200 Combination recorder

Compliance with CVR and FDR requirements may be achieved by:

- (a) one flight data and cockpit voice combination recorder in the case of aeroplanes required to be equipped with a CVR or an FDR;
- (b) one flight data and cockpit voice combination recorder in the case of aeroplanes with an MCTOM of 5 700 kg or less and required to be equipped with a CVR and an FDR; or
- (c) two flight data and cockpit voice combination recorders in the case of aeroplanes with an MCTOM of more than 5 700 kg and required to be equipped with a CVR and an FDR.

AMC1 CAT.IDE.A.200 Combination recorder

GENERAL

When two flight data and cockpit voice combination recorders are installed, one should be located near the flight crew compartment, in order to minimise the risk of data loss due to a failure of the wiring that gathers data to the recorder. The other should be located at the rear section of the aeroplane, in order to minimise the risk of data loss due to recorder damage in the case of a crash.

GM1 CAT.IDE.A.200 Combination recorder

GENERAL

- (a) A flight data and cockpit voice combination recorder is a flight recorder that records:
 - (1) all voice communications and aural environment required by CAT.IDE.A.185 regarding CVRs; and
 - (2) all parameters required by CAT.IDE.A.190 regarding FDRs,with the same specifications required by those paragraphs.
- (b) In addition, a flight data and cockpit voice combination recorder may record data link communication messages and related information required by CAT.IDE.A.195.

CAT.IDE.A.205 Seats, seat safety belts, restraint systems and child restraint devices

- (a) Aeroplanes shall be equipped with:
- (1) a seat or berth for each person on board who is aged 24 months or more;
 - (2) a seat belt on each passenger seat and restraining belts for each berth except as specified in (3);
 - (3) a seat belt with upper torso restraint system on each passenger seat and restraining belts on each berth in the case of aeroplanes with an MCTOM of less than 5700 kg and with an MOPSC of less than nine, having an individual CofA first issued on or after 8 April 2015;
 - (4) a child restraint device (CRD) for each person on board younger than 24 months;
 - (5) a seat belt with upper torso restraint system incorporating a device that will automatically restrain the occupant's torso in the event of rapid deceleration:
 - (i) on each flight crew seat and on any seat alongside a pilot's seat;
 - (ii) on each observer seat located in the flight crew compartment;
 - (6) a seat belt with upper torso restraint system on each seat for the minimum required cabin crew.
- (b) A seat belt with upper torso restraint system shall have:
- (1) a single point release;
 - (2) on the seats for the minimum required cabin crew, two shoulder straps and a seat belt that may be used independently; and
 - (3) on flight crew seats and on any seat alongside a pilot's seat:
 - (i) two shoulder straps and a seat belt that may be used independently; or
 - (ii) a diagonal shoulder strap and a seat belt that may be used independently for the following aeroplanes:
 - (A) aeroplanes with an MCTOM of less than 5 700 kg and with an MOPSC of less than nine that are compliant with the emergency landing dynamic conditions defined in the applicable certification specification;
 - (B) aeroplanes with an MCTOM of less than 5 700 kg and with an MOPSC of less than nine that are not compliant with the emergency landing dynamic conditions defined in the applicable certification specification and having an individual CofA first issued before 28 October 2014; and
 - (C) aeroplanes certified in accordance with CS-VLA or equivalent and CS-LSA or equivalent.

AMC1 CAT.IDE.A.205 Seats, seat safety belts, restraint systems and child restraint devices

CHILD RESTRAINT DEVICES (CRDS)

- (a) A CRD is considered to be acceptable if:
- (1) it is a 'supplementary loop belt' manufactured with the same techniques and the same materials as the approved safety belts; or
 - (2) it complies with (b).

- (b) Provided the CRD can be installed properly on the respective aircraft seat, the following CRDs are considered acceptable:
- (1) CRDs approved for use in aircraft by the competent authority on the basis of a technical standard and marked accordingly;
 - (2) CRDs approved for use in motor vehicles according to the UN standard ECE R 44, -03 or later series of amendments;
 - (3) CRDs approved for use in motor vehicles and aircraft according to Canadian CMVSS 213/213.1;
 - (4) CRDs approved for use in motor vehicles and aircraft according to US FMVSS No 213 and manufactured to these standards on or after 26 February 1985. US approved CRDs manufactured after this date must bear the following labels in red letters:
 - (i) 'THIS CHILD RESTRAINT SYSTEM CONFORMS TO ALL APPLICABLE FEDERAL MOTOR VEHICLE SAFETY STANDARDS'; and
 - (ii) 'THIS RESTRAINT IS CERTIFIED FOR USE IN MOTOR VEHICLES AND AIRCRAFT';
 - (5) CRDs qualified for use in aircraft according to the German 'Qualification Procedure for Child Restraint Systems for Use in Aircraft' (TÜV Doc.: TÜV/958-01/2001); and
 - (6) devices approved for use in cars, manufactured and tested to standards equivalent to those listed above. The device should be marked with an associated qualification sign, which shows the name of the qualification organisation and a specific identification number, related to the associated qualification project. The qualifying organisation should be a competent and independent organisation that is acceptable to the competent authority.
- (c) Location
- (1) Forward-facing CRDs may be installed on both forward-and rearward-facing passenger seats, but only when fitted in the same direction as the passenger seat on which they are positioned. Rearward-facing CRDs should only be installed on forward-facing passenger seats. A CRD should not be installed within the radius of action of an airbag unless it is obvious that the airbag is de-activated or it can be demonstrated that there is no negative impact from the airbag.
 - (2) An infant in a CRD should be located as near to a floor level exit as feasible.
 - (3) An infant in a CRD should not hinder evacuation for any passenger.
 - (4) An infant in a CRD should neither be located in the row (where rows are existing) leading to an emergency exit nor located in a row immediately forward or aft of an emergency exit. A window passenger seat is the preferred location. An aisle passenger seat or a cross aisle passenger seat that forms part of the evacuation route to exits is not recommended. Other locations may be acceptable provided the access of neighbour passengers to the nearest aisle is not obstructed by the CRD.
 - (5) In general, only one CRD per row segment is recommended. More than one CRD per row segment is allowed if the infants are from the same family or travelling group provided the infants are accompanied by a responsible adult sitting next to them.
 - (6) A row segment is the fraction of a row separated by two aisles or by one aisle and the aeroplane fuselage.
- (d) Installation

- (1) CRDs should only be installed on a suitable aeroplane seat with the type of connecting device they are approved or qualified for. For instance, CRDs to be connected by a three-point harness only (most rearward-facing baby CRDs currently available) should not be attached to an aeroplane seat with a lap belt only; a CRD designed to be attached to a vehicle seat only by means of rigid bar lower anchorages (ISO-FIX or US equivalent), should only be used on aeroplane seats that are equipped with such connecting devices and should not be attached by the aeroplane seat lap belt. The method of connecting should be the one shown in the manufacturer's instructions provided with each CRD.
 - (2) All safety and installation instructions should be followed carefully by the responsible adult accompanying the infant. Cabin crew should prohibit the use of any inadequately installed CRD or not qualified seat.
 - (3) If a forward-facing CRD with a rigid backrest is to be fastened by a lap belt, the restraint device should be fastened when the backrest of the passenger seat on which it rests is in a reclined position. Thereafter, the backrest is to be positioned upright. This procedure ensures better tightening of the CRD on the aircraft seat if the aircraft seat is reclinable.
 - (4) The buckle of the adult safety belt must be easily accessible for both opening and closing, and must be in line with the seat belt halves (not canted) after tightening.
 - (5) Forward-facing restraint devices with an integral harness must not be installed such that the adult safety belt is secured over the infant.
- (e) Operation
- (1) Each CRD should remain secured to a passenger seat during all phases of flight unless it is properly stowed when not in use.
 - (2) Where a CRD is adjustable in recline, it must be in an upright position for all occasions when passenger restraint devices are required.

AMC2 CAT.IDE.A.205 Seats, seat safety belts, restraint systems and child restraint devices

UPPER TORSO RESTRAINT SYSTEM

- (a) A restraint system, including a seat belt, two shoulder straps and additional straps is deemed to be compliant with the requirement for restraint systems with two shoulder straps.
- (b) An upper torso restraint system which restrains permanently the torso of the occupant is deemed to be compliant with the requirement for an upper torso restraint system incorporating a device that will automatically restrain the occupant's torso in the event of rapid deceleration.
- (c) The use of the upper torso restraint independently from the use of the seat belt is intended as an option for the comfort of the occupant of the seat in those phases of flight where only the seat belt is required to be fastened. A restraint system including a seat belt and an upper torso restraint that both remain permanently fastened is also acceptable.

SEAT BELT

- (d) A seat belt with a diagonal shoulder strap (three anchorage points) is deemed to be compliant with the requirement for a seat belt (two anchorage points).

AMC3 CAT.IDE.A.205 Seats, seat safety belts, restraint systems and child restraint devices

SEATS FOR MINIMUM REQUIRED CABIN CREW

- (a) Seats for the minimum required cabin crew members should be located near required floor level emergency exits, except if the emergency evacuation of passengers would be enhanced by seating cabin crew members elsewhere. In this case, other locations are acceptable.
- (b) Such seats should be forward-or rearward-facing within 15° of the longitudinal axis of the aeroplane.

GM1 CAT.IDE.A.205 Seats, seat safety belts, restraint systems and child restraint devices

EMERGENCY LANDING DYNAMIC CONDITIONS

Emergency landing dynamic conditions are defined in 23.562 of CS-23 or equivalent and in 25.562 of CS-25 or equivalent.

CAT.IDE.A.210 Fasten seat belt and no smoking signs

Aeroplanes in which not all passenger seats are visible from the flight crew seat(s) shall be equipped with a means of indicating to all passengers and cabin crew when seat belts shall be fastened and when smoking is not allowed.

CAT.IDE.A.215 Internal doors and curtains

Aeroplanes shall be equipped with:

- (a) in the case of aeroplanes with an MOPSC of more than 19, a door between the passenger compartment and the flight crew compartment, with a placard indicating 'crew only' and a locking means to prevent passengers from opening it without the permission of a member of the flight crew;
- (b) a readily accessible means for opening each door that separates a passenger compartment from another compartment that has emergency exits;
- (c) a means for securing in the open position any doorway or curtain separating the passenger compartment from other areas that need to be accessed to reach any required emergency exit from any passenger seat;
- (d) a placard on each internal door or adjacent to a curtain that is the means of access to a passenger emergency exit, to indicate that it shall be secured open during take-off and landing; and
- (e) a means for any member of the crew to unlock any door that is normally accessible to passengers and that can be locked by passengers.

CAT.IDE.A.220 First-aid kit

- (a) Aeroplanes shall be equipped with first-aid kits, in accordance with Table 1.

Table 1

Number of first-aid kits required

Number of passenger seats installed	Number of first-aid kits required
0-100	1
101-200	2
201-300	3
301-400	4
401-500	5
501 or more	6

- (b) First-aid kits shall be:
 - (1) readily accessible for use; and
 - (2) kept up to date.

AMC1 CAT.IDE.A.220 First-aid kit

CONTENT OF FIRST-AID KITS

- (a) First-aid kits should be equipped with appropriate and sufficient medications and instrumentation. However, these kits should be complemented by the operator according to the characteristics of the operation (scope of operation, flight duration, number and demographics of passengers, etc.).
- (b) The following should be included in the first-aid kit:
- (1) Equipment
 - (i) bandages (assorted sizes);
 - (ii) burns dressings (unspecified);
 - (iii) wound dressings (large and small);
 - (iv) adhesive dressings (assorted sizes);
 - (v) adhesive tape;
 - (vi) adhesive wound closures;
 - (vii) safety pins;
 - (viii) safety scissors;
 - (ix) antiseptic wound cleaner;
 - (x) disposable resuscitation aid;
 - (xi) disposable gloves;
 - (xii) tweezers: splinter; and
 - (xiii) thermometers (non-mercury).
 - (2) Medications
 - (i) simple analgesic (may include liquid form);
 - (ii) antiemetic;
 - (iii) nasal decongestant;
 - (iv) gastrointestinal antacid, in the case of aeroplanes carrying more than 9 passengers;
 - (v) anti-diarrhoeal medication, in the case of aeroplanes carrying more than 9 passengers; and
 - (vi) antihistamine.
 - (3) Other
 - (i) a list of contents in at least two languages (English and one other). This should include information on the effects and side effects of medications carried;
 - (ii) first-aid handbook, current edition;
 - (iii) medical incident report form;
 - (iv) biohazard disposal bags.
 - (4) An eye irrigator, whilst not required to be carried in the first-aid kit, should, where possible, be available for use on the ground.

AMC2 CAT.IDE.A.220 First-aid kit

MAINTENANCE OF FIRST-AID KITS

To be kept up to date, first-aid kits should be:

- (a) inspected periodically to confirm, to the extent possible, that contents are maintained in the condition necessary for their intended use;
- (b) replenished at regular intervals, in accordance with instructions contained on their labels, or as circumstances warrant; and
- (c) replenished after use in-flight at the first opportunity where replacement items are available.

CAT.IDE.A.225 Emergency medical kit

- (a) Aeroplanes with an MOPSC of more than 30 shall be equipped with an emergency medical kit when any point on the planned route is more than 60 minutes flying time at normal cruising speed from an aerodrome at which qualified medical assistance could be expected to be available.
- (b) The commander shall ensure that drugs are only administered by appropriately qualified persons.
- (c) The emergency medical kit referred to in (a) shall be:
 - (1) dust and moisture proof;
 - (2) carried in a way that prevents unauthorised access; and
 - (3) kept up to date.

AMC1 CAT.IDE.A.225 Emergency medical kit

CONTENT OF EMERGENCY MEDICAL KIT

- (a) Emergency medical kits should be equipped with appropriate and sufficient medications and instrumentation. However, these kits should be complemented by the operator according to the characteristics of the operation (scope of operation, flight duration, number and demographics of passengers, etc.).
- (b) The following should be included in the emergency medical kit:
 - (1) Equipment
 - (i) sphygmomanometer — non-mercury;
 - (ii) stethoscope;
 - (iii) syringes and needles;
 - (iv) intravenous cannulae (if intravenous fluids are carried in the first-aid kit, a sufficient supply of intravenous cannulae should be stored there as well);
 - (v) oropharyngeal airways (three sizes);
 - (vi) tourniquet;
 - (vii) disposable gloves;
 - (viii) needle disposal box;
 - (ix) one or more urinary catheter(s), appropriate for either sex, and anaesthetic gel;
 - (x) basic delivery kit;
 - (xi) bag-valve masks (masks two sizes: one for adults, one for children);
 - (xii) intubation set;
 - (xiii) aspirator;
 - (xiv) blood glucose testing equipment; and
 - (xv) scalpel.
 - (2) Instructions: the instructions should contain a list of contents (medications in trade names and generic names) in at least two languages (English and one other). This should include information on the effects and side effects of medications carried. There should also be basic instructions for use of the medications in the kit and ACLS cards (summarising and depicting the current algorithm for advanced cardiac life support).

- (3) Medications
- (i) coronary vasodilator e.g. glyceriltrinitrate-oral;
 - (ii) antispasmodic
 - (iii) epinephrine/adrenaline 1:1 000 (if a cardiac monitor is carried);
 - (iv) adrenocorticoid — injectable;
 - (v) major analgesic;
 - (vi) diuretic — injectable;
 - (vii) antihistamine — oral and injectable;
 - (viii) sedative/anticonvulsant — injectable, rectal and oral sedative;
 - (ix) medication for hypoglycaemia (e.g. hypertonic glucose);
 - (x) antiemetic;
 - (xi) atropine — injectable;
 - (xii) bronchial dilator — injectable or inhaled;
 - (xiii) IV fluids in appropriate quantity e.g. sodiumchloride 0.9 % (minimum 250 ml);
 - (xiv) acetylsalicylic acid 300 mg — oral and/or injectable;
 - (xv) antiarrhythmic — if a cardiac monitor is carried;
 - (xvi) antihypertensive medication;
 - (xvii) beta-blocker — oral.
- * Epinephrine/Adrenaline 1:10 000 can be a dilution of epinephrine 1:1 000
- (4) The carriage of an automated external defibrillator should be determined by the operator on the basis of a risk assessment taking into account the particular needs of the operation.
- (5) The automated external defibrillator should be carried on the aircraft, though not necessarily in the emergency medical kit.

AMC2 CAT.IDE.A.225 Emergency medical kit

CARRIAGE UNDER SECURITY CONDITIONS

The emergency medical kit should be kept in under secure conditions, either in the flight crew compartment or in another locked compartment.

AMC3 CAT.IDE.A.225 Emergency medical kit

ACCESS TO EMERGENCY MEDICAL KIT

- (a) When the actual situation on board so requires, the commander should limit access to the emergency medical kit.
- (b) Drugs should be administered by medical doctors, qualified nurses, paramedics or emergency medical technicians.
- (c) Medical students, student paramedics, student emergency medical technicians or nurses aids should only administer drugs if no person mentioned in (b) is on board the flight and appropriate advice has been received.

- (d) Oral drugs should not be denied in medical emergency situations where no medically qualified persons are on board the flight.

AMC4 CAT.IDE.A.225 Emergency medical kit

Maintenance of emergency medical kit

To be kept up to date, the emergency medical kit should be:

- (a) inspected periodically to confirm, to the extent possible, that the contents are maintained in the condition necessary for their intended use;
- (b) replenished at regular intervals, in accordance with instructions contained on their labels, or as circumstances warrant; and
- (c) replenished after use-in-flight at the first opportunity where replacement items are available.

CAT.IDE.A.230 First-aid oxygen

- (a) Pressurised aeroplanes operated at pressure altitudes above 25 000 ft, in the case of operations for which a cabin crew member is required, shall be equipped with a supply of undiluted oxygen for passengers who, for physiological reasons, might require oxygen following a cabin depressurisation.
- (b) The oxygen supply referred to in (a) shall be calculated using an average flow rate of at least 3 litres standard temperature pressure dry (STPD)/minute/person. This oxygen supply shall be sufficient for the remainder of the flight after cabin depressurisation when the cabin altitude exceeds 8000 ft but does not exceed 15 000 ft, for at least 2 % of the passengers carried, but in no case for less than one person.
- (c) There shall be a sufficient number of dispensing units, but in no case less than two, with a means for cabin crew to use the supply.
- (d) The first-aid oxygen equipment shall be capable of generating a mass flow to each user of at least 4 litres STPD per minute.

GM1 CAT.IDE.A.230 First-aid oxygen

GENERAL

- (a) First-aid oxygen is intended for those passengers who still need to breathe oxygen when the amount of supplemental oxygen required under CAT.IDE.A.235 or CAT.IDE.A.240 has been exhausted.
- (b) When calculating the amount of first-aid oxygen, the operator should take into account the fact that, following a cabin depressurisation, supplemental oxygen as calculated in accordance with Table 1 of CAT.IDE.A.235 and Table 1 of CAT.IDE.A.240 should be sufficient to cope with potential effects of hypoxia for:
 - (1) all passengers when the cabin altitude is above 15 000 ft;
 - (2) at least 30 % of the passengers, for any period when, in the event of loss of pressurisation and taking into account the circumstances of the flight, the pressure altitude in the passenger compartment will be between 14 000 ft and 15 000 ft; and
 - (3) at least 10 % of the passengers for any period in excess of 30 minutes when the pressure altitude in the passenger compartment will be between 10 000 ft and 14 000 ft.
- (c) For the above reasons, the amount of first-aid oxygen should be calculated for the part of the flight after cabin depressurisation during which the cabin altitude is between 8 000 ft and 15 000 ft, when supplemental oxygen may no longer be available.
- (d) Moreover, following cabin depressurisation, an emergency descent should be carried out to the lowest altitude compatible with the safety of the flight. In addition, in these circumstances, the aeroplane should land at the first available aerodrome at the earliest opportunity.
- (e) The conditions above may reduce the period of time during which the first-aid oxygen may be required and consequently may limit the amount of first-aid oxygen to be carried on board.
- (f) Means may be provided to decrease the flow to not less than 2 litres per minute, STPD, at any altitude.

CAT.IDE.A.235 Supplemental oxygen — pressurised aeroplanes

- (a) Pressurised aeroplanes operated at pressure altitudes above 10 000 ft shall be equipped with supplemental oxygen equipment that is capable of storing and dispensing the oxygen supplies in accordance with Table 1.
- (b) Pressurised aeroplanes operated at pressure altitudes above 25 000 ft shall be equipped with:
 - (1) quick donning types of masks for flight crew members;
 - (2) sufficient spare outlets and masks or portable oxygen units with masks distributed evenly throughout the passenger compartment, to ensure immediate availability of oxygen for use by each required cabin crew member;
 - (3) an oxygen dispensing unit connected to oxygen supply terminals immediately available to each cabin crew member, additional crew member and occupants of passenger seats, wherever seated; and
 - (4) a device to provide a warning indication to the flight crew of any loss of pressurisation.
- (c) In the case of pressurised aeroplanes first issued with an individual CofA after 8 November 1998 and operated at pressure altitudes above 25 000 ft, or operated at pressure altitudes at, or below 25 000 ft under conditions that would not allow them to descend safely to 13 000 ft within four minutes, the individual oxygen dispensing units referred to in (b)(3) shall be automatically deployable.
- (d) The total number of dispensing units and outlets referred to in (b)(3) and (c) shall exceed the number of seats by at least 10 %. The extra units shall be evenly distributed throughout the passenger compartment.
- (e) Notwithstanding (a), the oxygen supply requirements for cabin crew member(s), additional crew member(s) and passenger(s), in the case of aeroplanes not certified to fly at altitudes above 25 000 ft, may be reduced to the entire flying time between 10 000 ft and 13 000 ft cabin pressure altitudes for all required cabin crew members and for at least 10 % of the passengers if, at all points along the route to be flown, the aeroplane is able to descend safely within four minutes to a cabin pressure altitude of 13 000 ft.
- (f) The required minimum supply in Table 1, row 1 item (b)(1) and row 2, shall cover the quantity of oxygen necessary for a constant rate of descent from the aeroplane's maximum certified operating altitude to 10 000 ft in 10 minutes and followed by 20 minutes at 10 000 ft.
- (g) The required minimum supply in Table 1, row 1 item 1(b)(2), shall cover the quantity of oxygen necessary for a constant rate of descent from the aeroplane's maximum certified operating altitude to 10 000 ft in 10 minutes followed by 110 minutes at 10 000 ft.
- (h) The required minimum supply in Table 1, row 3, shall cover the quantity of oxygen necessary for a constant rate of descent from the aeroplane's maximum certified operating altitude to 15 000 ft in 10 minutes.

Table 1

Oxygen minimum requirements for pressurised aeroplanes

Supply for	Duration and cabin pressure altitude
1. Occupants of flight crew compartment seats on flight crew compartment duty	(a) The entire flying time when the cabin pressure altitude exceeds 13 000 ft. (b) The remainder of the flying time when the cabin pressure altitude exceeds 10 000 ft but does not exceed 13 000 ft, after the initial 30 minutes at these altitudes, but in no case less than: <ul style="list-style-type: none"> (1) 30 minutes' supply for aeroplanes certified to fly at altitudes not exceeding 25 000 ft; and (2) 2 hours' supply for aeroplanes certified to fly at altitudes of more than 25 000 ft.
2. Required cabin crew members	(a) The entire flying time when the cabin pressure altitude exceeds 13 000 ft, but not less than 30 minutes' supply. (b) The remainder of the flying time when the cabin pressure altitude exceeds 10 000 ft but does not exceed 13 000 ft, after the initial 30 minutes at these altitudes.
3. 100 % of passengers ⁽¹⁾	The entire flying time when the cabin pressure altitude exceeds 15 000 ft, but in no case less than 10 minutes' supply.
4. 30 % of passengers ⁽¹⁾	The entire flying time when the cabin pressure altitude exceeds 14000 ft but does not exceed 15 000 ft.
5. 10 % of passengers ⁽¹⁾	The remainder of the flying time when the cabin pressure altitude exceeds 10 000 ft but does not exceed 14000 ft, after the initial 30 minutes at these altitudes.
⁽¹⁾ Passenger numbers in Table 1 refer to passengers actually carried on board, including persons younger than 24 months.	

AMC1 CAT.IDE.A.235 Supplemental oxygen — pressurised aeroplanes**DETERMINATION OF OXYGEN**

- (a) In the determination of the amount of supplemental oxygen required for the routes to be flown, it is assumed that the aeroplane will descend in accordance with the emergency procedures specified in the operations manual, without exceeding its operating limitations, to a flight altitude that will allow the flight to be completed safely (i.e. flight altitudes ensuring adequate terrain clearance, navigational accuracy, hazardous weather avoidance, etc.).
- (b) The amount of supplemental oxygen should be determined on the basis of cabin pressure altitude, flight duration and on the assumption that a cabin pressurisation failure will occur at the pressure altitude or point of flight that is most critical from the standpoint of oxygen need.
- (c) Following a cabin pressurisation failure, the cabin pressure altitude should be considered to be the same as the aeroplane pressure altitude unless it can be demonstrated to the competent authority

that no probable failure of the cabin or pressurisation system will result in a cabin pressure altitude equal to the aeroplane pressure altitude. Under these circumstances, the demonstrated maximum cabin pressure altitude may be used as a basis for determination of oxygen supply.

AMC2 CAT.IDE.A.235 Supplemental oxygen — pressurised aeroplanes**OXYGEN REQUIREMENTS FOR FLIGHT CREW COMPARTMENT SEAT OCCUPANTS AND CABIN CREW IN ADDITION TO THE REQUIRED MINIMUM NUMBER OF CABIN CREW**

- (a) For the purpose of supplemental oxygen supply, flight crew compartment seat occupants who are:
 - (1) supplied with oxygen from the flight crew source of oxygen should be considered as flight crew members; and
 - (2) not supplied with oxygen by the flight crew source of oxygen should be considered as passengers.
- (b) Cabin crew members in addition to the minimum number of cabin crew and additional crew members should be considered as passengers for the purpose of supplemental oxygen supply.

AMC1 CAT.IDE.A.235(e) Supplemental oxygen — pressurised aeroplanes**AEROPLANES NOT CERTIFIED TO FLY ABOVE 25 000 FT**

- (a) With respect to CAT.IDE.A.235(e), the maximum altitude up to which an aeroplane can operate without a passenger oxygen system being installed and capable of providing oxygen to each cabin occupant, should be established using an emergency descent profile that takes into account the following conditions:
 - (1) 17 seconds' time delay for pilot's recognition and reaction, including mask donning, for trouble shooting and configuring the aeroplane for the emergency descent (emergency descent data/charts established by the aeroplane manufacturer and published in the aircraft flight manual (AFM), and/or the AFM should be used to ensure uniform application of the option); and
 - (2) maximum operational speed (V_{MO}) or the airspeed approved in the AFM for emergency descent, (emergency descent data/charts established by the aeroplane manufacturer and published in the AFM, and/or AFM should be used to ensure uniform application of the option), whichever is the less;
- (b) On routes where oxygen is necessary to be carried for 10 % of the passengers for the flight time between 10 000 ft and 13 000 ft, the oxygen should be provided either by:
 - (1) a plug-in or drop-out oxygen system with sufficient outlets and dispensing units uniformly distributed throughout the cabin so as to provide oxygen to each passenger at his/her own discretion when seated on his/her assigned seat; or
 - (2) portable bottles, when a cabin crew member is required on board such flight.

GM1 CAT.IDE.A.235(b)(1) Supplemental oxygen — pressurised aeroplanes

QUICK DONNING MASKS

A quick donning mask is a type of mask that:

- (a) can be placed on the face from its ready position, properly secured, sealed and supplying oxygen upon demand, with one hand and within 5 seconds and will thereafter remain in position, both hands being free;
- (b) can be donned without disturbing eye glasses and without delaying the flight crew member from proceeding with assigned emergency duties;
- (c) once donned, does not prevent immediate communication between the flight crew members and other crew members over the aircraft intercommunication system; and
- (d) does not inhibit radio communications.

CAT.IDE.A.240 Supplemental oxygen — non-pressurised aeroplanes

Non-pressurised aeroplanes operated at pressure altitudes above 10 000 ft shall be equipped with supplemental oxygen equipment capable of storing and dispensing the oxygen supplies in accordance with Table 1.

Table 1

Oxygen minimum requirements for non-pressurised aeroplanes

Supply for	Duration and cabin pressure altitude
1. Occupants of flight crew compartment seats on flight crew compartment duty and crew members assisting flight crew in their duties	The entire flying time at pressure altitudes above 10 000 ft.
2. Required cabin crew members	The entire flying time at pressure altitudes above 13 000 ft and for any period exceeding 30 minutes at pressure altitudes above 10 000 ft but not exceeding 13 000 ft.
3. Additional crew members and 100 % of passengers ⁽¹⁾	The entire flying time at pressure altitudes above 13 000 ft.
4. 10 % of passengers ⁽¹⁾	The entire flying time after 30 minutes at pressure altitudes above 10 000 ft but not exceeding 13 000 ft.
⁽¹⁾ Passenger numbers in Table 1 refer to passengers actually carried on board, including persons younger than 24 months.	

AMC1 CAT.IDE.A.240 Supplemental oxygen — non-pressurised aeroplanes**AMOUNT OF SUPPLEMENTAL OXYGEN**

The amount of supplemental oxygen for sustenance for a particular operation should be determined on the basis of flight altitudes and flight duration, consistent with the operating procedures, including emergency procedures, established for each operation and the routes to be flown, as specified in the operations manual.

CAT.IDE.A.245 Crew protective breathing equipment

- (a) All pressurised aeroplanes and those unpressurised aeroplanes with an MCTOM of more than 5 700 kg or having an MOPSC of more than 19 seats shall be equipped with protective breathing equipment (PBE) to protect the eyes, nose and mouth and to provide for a period of at least 15 minutes:
- (1) oxygen for each flight crew member on duty in the flight crew compartment;
 - (2) breathing gas for each required cabin crew member, adjacent to his/her assigned station; and
 - (3) breathing gas from a portable PBE for one member of the flight crew, adjacent to his/her assigned station, in the case of aeroplanes operated with a flight crew of more than one and no cabin crew member.
- (b) A PBE intended for flight crew use shall be installed in the flight crew compartment and be accessible for immediate use by each required flight crew member at his/her assigned station.
- (c) A PBE intended for cabin crew use shall be installed adjacent to each required cabin crew member station.
- (d) Aeroplanes shall be equipped with an additional portable PBE installed adjacent to the hand fire extinguisher referred to in CAT.IDE.A.250, or adjacent to the entrance of the cargo compartment, in case the hand fire extinguisher is installed in a cargo compartment.
- (e) A PBE while in use shall not prevent the use of the means of communication referred to in CAT.IDE.A.170, CAT.IDE.A.175, CAT.IDE.A.270 and CAT.IDE.A.330.

AMC1 CAT.IDE.A.245 Crew protective breathing equipment

PROTECTIVE BREATHING EQUIPMENT (PBE)

The supply for PBE for the flight crew members may be provided by the supplemental oxygen required in CAT.IDE.A.235 or CAT.IDE.A.240.

CAT.IDE.A.250 Hand fire extinguishers

- (a) Aeroplanes shall be equipped with at least one hand fire extinguisher in the flight crew compartment.
- (b) At least one hand fire extinguisher shall be located in, or readily accessible for use in, each galley not located on the main passenger compartment.
- (c) At least one hand fire extinguisher shall be available for use in each class A or class B cargo or baggage compartment and in each class E cargo compartment that is accessible to crew members in flight.
- (d) The type and quantity of extinguishing agent for the required fire extinguishers shall be suitable for the type of fire likely to occur in the compartment where the extinguisher is intended to be used and to minimise the hazard of toxic gas concentration in compartments occupied by persons.
- (e) Aeroplanes shall be equipped with at least a number of hand fire extinguishers in accordance with Table 1, conveniently located to provide adequate availability for use in each passenger compartment.

Table 1**Number of hand fire extinguishers**

MOPSC	Number of extinguishers
7-30	1
31-60	2
61-200	3
201-300	4
301-400	5
401-500	6
501-600	7
601 or more	8

AMC1 CAT.IDE.A.250 Hand fire extinguishers**NUMBER, LOCATION AND TYPE**

- (a) The number and location of hand fire extinguishers should be such as to provide adequate availability for use, account being taken of the number and size of the passenger compartments, the need to minimise the hazard of toxic gas concentrations and the location of lavatories, galleys, etc. These considerations may result in a number of fire extinguishers greater than the minimum required.
- (b) There should be at least one hand fire extinguisher installed in the flight crew compartment and this should be suitable for fighting both flammable fluid and electrical equipment fires. Additional

hand fire extinguishers may be required for the protection of other compartments accessible to the crew in flight. Dry chemical fire extinguishers should not be used in the flight crew compartment, or in any compartment not separated by a partition from the flight crew compartment, because of the adverse effect on vision during discharge and, if conductive, interference with electrical contacts by the chemical residues.

- (c) Where only one hand fire extinguisher is required in the passenger compartments, it should be located near the cabin crew member's station, where provided.
- (d) Where two or more hand fire extinguishers are required in the passenger compartments and their location is not otherwise dictated by consideration of CAT.IDE.A.250(b), an extinguisher should be located near each end of the cabin with the remainder distributed throughout the cabin as evenly as is practicable.
- (e) Unless an extinguisher is clearly visible, its location should be indicated by a placard or sign. Appropriate symbols may also be used to supplement such a placard or sign.

CAT.IDE.A.255 Crash axe and crowbar

- (a) Aeroplanes with an MCTOM of more than 5 700 kg or with an MOPSC of more than nine shall be equipped with at least one crash axe or crowbar located in the flight crew compartment.
- (b) In the case of aeroplanes with an MOPSC of more than 200, an additional crash axe or crowbar shall be installed in or near the rearmost galley area.
- (c) Crash axes and crowbars located in the passenger compartment shall not be visible to passengers.

AMC1 CAT.IDE.A.255 Crash axe and crowbar**STORAGE OF CRASH AXES AND CROWBARS**

Crash axes and crowbars located in the passenger compartment should be stored in a position not visible to passengers.

CAT.IDE.A.260 Marking of break-in points

If areas of the aeroplane's fuselage suitable for break-in by rescue crews in an emergency are marked, such areas shall be marked as shown in Figure 1.

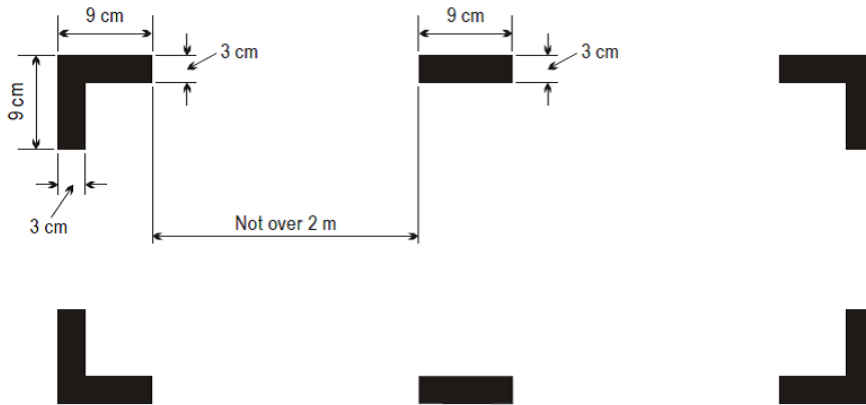
Figure 1**AMC1 CAT.IDE.A.260 Marking of break-in points****MARKINGS — COLOUR AND CORNERS**

- (a) The colour of the markings should be red or yellow and, if necessary, should be outlined in white to contrast with the background.
- (b) If the corner markings are more than 2 m apart, intermediate lines 9 cm x 3 cm should be inserted so that there is no more than 2 m between adjacent markings.

CAT.IDE.A.265 Means for emergency evacuation

- (a) Aeroplanes with passenger emergency exit sill heights of more than 1,83 m (6 ft) above the ground shall be equipped at each of those exits with a means to enable passengers and crew to reach the ground safely in an emergency.
- (b) Notwithstanding (a), such means are not required at overwing exits if the designated place on the aeroplane structure at which the escape route terminates is less than 1,83 m (6 ft) from the ground with the aeroplane on the ground, the landing gear extended, and the flaps in the take-off or landing position, whichever flap position is higher from the ground.
- (c) Aeroplanes required to have a separate emergency exit for the flight crew for which the lowest point of the emergency exit is more than 1,83 m (6 ft) above the ground shall have a means to assist all flight crew members in descending to reach the ground safely in an emergency.
- (d) The heights referred to in (a) and (c) shall be measured:
- (1) with the landing gear extended; and
 - (2) after the collapse of, or failure to extend of, one or more legs of the landing gear, in the case of aeroplanes with a type certificate issued after 31 March 2000.

CAT.IDE.A.270 Megaphones

Aeroplanes with an MOPSC of more than 60 and carrying at least one passenger shall be equipped with the following quantities of portable battery-powered megaphones readily accessible for use by crew members during an emergency evacuation:

- (a) For each passenger deck:

Table 1

Number of megaphones

Passenger seating configuration	Number of megaphones
61 to 99	1
100 or more	2

- (b) For aeroplanes with more than one passenger deck, in all cases when the total passenger seating configuration is more than 60, at least one megaphone.

AMC1 CAT.IDE.A.270 Megaphones**LOCATION OF MEGAPHONES**

- (a) Where one megaphone is required, it should be readily accessible at the assigned seat of a cabin crew member or crew members other than flight crew.
- (b) Where two or more megaphones are required, they should be suitably distributed in the passenger compartment(s) and readily accessible to crew members assigned to direct emergency evacuations.
- (c) This does not necessarily require megaphones to be positioned such that they can be physically reached by a crew member when strapped in a cabin crew member's seat.

CAT.IDE.A.275 Emergency lighting and marking

- (a) Aeroplanes with an MOPSC of more than nine shall be equipped with an emergency lighting system having an independent power supply to facilitate the evacuation of the aeroplane.
- (b) In the case of aeroplanes with an MOPSC of more than 19, the emergency lighting system, referred to in (a) shall include:
 - (1) sources of general cabin illumination;
 - (2) internal lighting in floor level emergency exit areas;
 - (3) illuminated emergency exit marking and locating signs;
 - (4) in the case of aeroplanes for which the application for the type certificate or equivalent was filed before 1 May 1972, when operated by night, exterior emergency lighting at all overwing exits and at exits where descent assist means are required;
 - (5) in the case of aeroplanes for which the application for the type certificate or equivalent was filed after 30 April 1972, when operated by night, exterior emergency lighting at all passenger emergency exits; and
 - (6) in the case of aeroplanes for which the type certificate was first issued on or after 31 December 1957, floor proximity emergency escape path marking system(s) in the passenger compartments.
- (c) In the case of aeroplanes with an MOPSC of 19 or less and type certified on the basis of the Agency's airworthiness codes, the emergency lighting system, referred to in (a) shall include the equipment referred to in (b)(1) to (3).
- (d) In the case of aeroplanes with an MOPSC of 19 or less that are not certified on the basis of the Agency's airworthiness codes, the emergency lighting system, referred to in (a) shall include the equipment referred to in (b)(1).
- (e) Aeroplanes with an MOPSC of nine or less, operated at night, shall be equipped with a source of general cabin illumination to facilitate the evacuation of the aeroplane.

CAT.IDE.A.280 Emergency locator transmitter (ELT)

- (a) Aeroplanes with an MOPSC of more than 19 shall be equipped with at least:
 - (1) two ELTs, one of which shall be automatic, or one ELT and one aircraft localisation means meeting the requirement of CAT.GEN.MPA.210, in the case of aeroplanes first issued with an individual CofA after 1 July 2008; or
 - (2) one automatic ELT or two ELTs of any type or one aircraft localisation means meeting the requirement of CAT.GEN.MPA.210, in the case of aeroplanes first issued with an individual CofA on or before 1 July 2008.
- (b) Aeroplanes with an MOPSC of 19 or less shall be equipped with at least:
 - (1) one automatic ELT or one aircraft localisation means meeting the requirement of CAT.GEN.MPA.210, in the case of aeroplanes first issued with an individual CofA after 1 July 2008; or
 - (2) one ELT of any type or one aircraft localisation means meeting the requirement of CAT.GEN.MPA.210, in the case of aeroplanes first issued with an individual CofA on or before 1 July 2008.
- (c) An ELT of any type shall be capable of transmitting simultaneously on 121,5 MHz and 406 MHz.

AMC1 CAT.IDE.A.280 Emergency locator transmitter (ELT)

BATTERIES

- (a) All batteries used in ELTs should be replaced (or recharged if the battery is rechargeable) when the equipment has been in use for more than 1 cumulative hour or in the following cases:
- (1) Batteries specifically designed for use in ELTs and having an airworthiness release certificate (EASA Form 1 or equivalent) should be replaced (or recharged if the battery is rechargeable) before the end of their useful life in accordance with the maintenance instructions applicable to the ELT.
 - (2) Standard batteries manufactured in accordance with an industry standard and not having an airworthiness release certificate (EASA Form 1 or equivalent), when used in ELTs should be replaced (or recharged if the battery is rechargeable) when 50 % of their useful life (or for rechargeable, 50 % of their useful life of charge), as established by the battery manufacturer, has expired.
 - (3) The battery useful life (or useful life of charge) criteria in (1) and (2) do not apply to batteries (such as water-activated batteries) that are essentially unaffected during probable storage intervals.
- (b) The new expiry date for a replaced (or recharged) battery should be legibly marked on the outside of the equipment.

AMC2 CAT.IDE.A.280 Emergency locator transmitter (ELT)

TYPES OF ELT AND GENERAL TECHNICAL SPECIFICATIONS

- (a) The ELT required by this provision should be one of the following:
- (1) Automatic fixed (ELT(AF)). An automatically activated ELT that is permanently attached to an aircraft and is designed to aid search and rescue (SAR) teams in locating the crash site.
 - (2) Automatic portable (ELT(AP)). An automatically activated ELT, that is rigidly attached to an aircraft before a crash, but is readily removable from the aircraft after a crash. It functions as an ELT during the crash sequence. If the ELT(AP) does not employ an integral antenna, the aircraft-mounted antenna may be disconnected and an auxiliary antenna (stored on the ELT case) attached to the ELT. The ELT can be tethered to a survivor or a life-raft. This type of ELT is intended to aid SAR teams in locating the crash site or survivor(s).
 - (3) Automatic deployable (ELT(AD))an ELT that is rigidly attached to the aircraft before the crash and that is automatically ejected, deployed and activated by an impact, and, in some cases, also by hydrostatic sensors. Manual deployment is also provided. This type of ELT should float in water and is intended to aid SAR teams in locating the crash site.
 - (4) Survival ELT (ELT(S)). An ELT that is removable from an aircraft, stowed so as to facilitate its ready use in an emergency, and manually activated by a survivor. An ELT(S) may be activated manually or automatically (e.g. by water activation). It should be designed either to be tethered to a life-raft or a survivor.
- (b) To minimise the possibility of damage in the event of crash impact, the automatic ELT should be rigidly fixed to the aircraft structure, as far aft as is practicable, with its antenna and connections arranged so as to maximise the probability of the signal being transmitted after a crash.
- (c) Any ELT carried should operate in accordance with the relevant provisions of ICAO Annex 10, Volume III communications systems and should be registered with the national agency responsible for initiating search and rescue or other nominated agency.

GM1 CAT.IDE.A.280 Emergency locator transmitter (ELT)

TERMINOLOGY

'ELT' is a generic term describing equipment that broadcasts distinctive signals on designated frequencies and, depending on application, may be activated by impact or may be manually activated.

CAT.IDE.A.285 Flight over water

- (a) The following aeroplanes shall be equipped with a life-jacket for each person on board or equivalent flotation device for each person on board younger than 24 months, stowed in a position that is readily accessible from the seat or berth of the person for whose use it is provided:
- (1) landplanes operated over water at a distance of more than 50 NM from the shore or taking off or landing at an aerodrome where the take-off or approach path is so disposed over water that there would be a likelihood of a ditching; and
 - (2) seaplanes operated over water.
- (b) Each life-jacket or equivalent individual flotation device shall be equipped with a means of electric illumination for the purpose of facilitating the location of persons.
- (c) Seaplanes operated over water shall be equipped with:
- (1) a sea anchor and other equipment necessary to facilitate mooring, anchoring or manoeuvring the seaplane on water, appropriate to its size, weight and handling characteristics; and
 - (2) equipment for making the sound signals as prescribed in the International Regulations for Preventing Collisions at Sea, where applicable.
- (d) Aeroplanes operated over water at a distance away from land suitable for making an emergency landing, greater than that corresponding to:
- (1) 120 minutes at cruising speed or 400 NM, whichever is the lesser, in the case of aeroplanes capable of continuing the flight to an aerodrome with the critical engine(s) becoming inoperative at any point along the route or planned diversions; or
 - (2) for all other aeroplanes, 30 minutes at cruising speed or 100 NM, whichever is the lesser, shall be equipped with the equipment specified in (e).
- (e) Aeroplanes complying with (d) shall carry the following equipment:
- (1) life-rafts in sufficient numbers to carry all persons on board, stowed so as to facilitate their ready use in an emergency, and being of sufficient size to accommodate all the survivors in the event of a loss of one raft of the largest rated capacity;
 - (2) a survivor locator light in each life-raft;
 - (3) life-saving equipment to provide the means for sustaining life, as appropriate for the flight to be undertaken; and
 - (4) at least two survival ELTs (ELT(S)).
- (f) By 1 January 2019 at the latest, aeroplanes with an MCTOM of more than 27 000 kg and with an MOPSC of more than 19 and all aeroplanes with an MCTOM of more than 45 500 kg shall be fitted with a securely attached underwater locating device that operates at a frequency of 8,8 kHz \pm 1 kHz, unless:
- (1) the aeroplane is operated over routes on which it is at no point at a distance of more than 180 NM from the shore; or
 - (2) the aeroplane is equipped with robust and automatic means to accurately determine, following an accident where the aeroplane is severely damaged, the location of the point of end of flight.

AMC1 CAT.IDE.A.285 Flight over water

LIFE RAFTS AND EQUIPMENT FOR MAKING DISTRESS SIGNALS

- (a) The following should be readily available with each life-raft:
- (1) means for maintaining buoyancy;
 - (2) a sea anchor;
 - (3) life-lines and means of attaching one life-raft to another;
 - (4) paddles for life-rafts with a capacity of six or less;
 - (5) means of protecting the occupants from the elements;
 - (6) a water-resistant torch;
 - (7) signalling equipment to make the pyrotechnic distress signals described in ICAO Annex 2, 'Rules of the Air';
 - (8) 100 g of glucose tablets for each four, or fraction of four, persons that the life-raft is designed to carry;
 - (9) at least 2 litres of drinkable water provided in durable containers or means of making sea water drinkable or a combination of both; and
 - (10) first-aid equipment.
- (b) As far as practicable, items listed in (a) should be contained in a pack.

AMC1 CAT.IDE.A.285(e)(4) & CAT.IDE.A.305(a)(2) Flight over water & Survival equipment

SURVIVAL ELT

An ELT(AP) may be used to replace one required ELT(S) provided that it meets the ELT(S) requirements. A water-activated ELT(S) is not an ELT(AP).

AMC1 CAT.IDE.A.285(a) Flight over water

ACCESSIBILITY OF LIFE-JACKETS

The life-jacket should be accessible from the seat or berth of the person for whose use it is provided, with a safety belt or restraint system fastened.

AMC2 CAT.IDE.A.285(a) Flight over water

ELECTRIC ILLUMINATION OF LIFE-JACKETS

The means of electric illumination should be a survivor locator light as defined in the applicable ETSO issued by the Agency or equivalent.

GM1 CAT.IDE.A.285(a) Flight over water

SEAT CUSHIONS

Seat cushions are not considered to be flotation devices.

AMC1 CAT.IDE.A.285(f) Flight over water

LOW-FREQUENCY UNDERWATER LOCATING DEVICE

- (a) The underwater locating device should be compliant with ETSO-C200 or equivalent.
- (b) The underwater locating device should not be installed in wings or empennage.

CAT.IDE.A.305 Survival equipment

- (a) Aeroplanes operated over areas in which search and rescue would be especially difficult shall be equipped with:
- (1) signalling equipment to make the distress signals;
 - (2) at least one ELT(S); and
 - (3) additional survival equipment for the route to be flown taking account of the number of persons on board.
- (b) The additional survival equipment specified in (a)(3) does not need to be carried when the aeroplane:
- (1) remains within a distance from an area where search and rescue is not especially difficult corresponding to:
 - (i) 120 minutes at one-engine-inoperative (OEI) cruising speed for aeroplanes capable of continuing the flight to an aerodrome with the critical engine(s) becoming inoperative at any point along the route or planned diversion routes; or
 - (ii) 30 minutes at cruising speed for all other aeroplanes;
 - (2) remains within a distance no greater than that corresponding to 90 minutes at cruising speed from an area suitable for making an emergency landing, for aeroplanes certified in accordance with the applicable airworthiness standard.

AMC1 CAT.IDE.A.305 Survival equipment

ADDITIONAL SURVIVAL EQUIPMENT

- (a) The following additional survival equipment should be carried when required:
- (1) 2 litres of drinkable water for each 50, or fraction of 50, persons on board provided in durable containers;
 - (2) one knife;
 - (3) first-aid equipment; and
 - (4) one set of air/ground codes.
- (b) In addition, when polar conditions are expected, the following should be carried:
- (1) a means for melting snow;
 - (2) one snow shovel and one ice saw;
 - (3) sleeping bags for use by 1/3 of all persons on board and space blankets for the remainder or space blankets for all passengers on board; and
 - (4) one arctic/polar suit for each crew member.
- (c) If any item of equipment contained in the above list is already carried on board the aeroplane in accordance with another requirement, there is no need for this to be duplicated.

AMC1 CAT.IDE.A.285(e)(4) & CAT.IDE.A.305(a)(2) Flight over water & Survival equipment

See [here](#).

AMC1 CAT.IDE.A.305(b)(2) Survival equipment

APPLICABLE AIRWORTHINESS STANDARD

The applicable airworthiness standard should be CS-25 or equivalent.

GM1 CAT.IDE.A.305 Survival equipment

SIGNALLING EQUIPMENT

The signalling equipment for making distress signals is described in ICAO Annex 2, Rules of the Air.

GM2 CAT.IDE.A.305 Survival equipment

AREAS IN WHICH SEARCH AND RESCUE WOULD BE ESPECIALLY DIFFICULT

The expression ‘areas in which search and rescue would be especially difficult’ should be interpreted, in this context, as meaning:

- (a) areas so designated by the authority responsible for managing search and rescue; or
- (b) areas that are largely uninhabited and where:
 - (1) the authority referred to in (a) has not published any information to confirm whether search and rescue would be or would not be especially difficult; and
 - (2) the authority referred to in (a) does not, as a matter of policy, designate areas as being especially difficult for search and rescue.

CAT.IDE.A.325 Headset

- (a) Aeroplanes shall be equipped with a headset with a boom or throat microphone or equivalent for each flight crew member at their assigned station in the flight crew compartment.
- (b) Aeroplanes operated under IFR or at night shall be equipped with a transmit button on the manual pitch and roll control for each required flight crew member.

AMC1 CAT.IDE.A.325 Headset

GENERAL

- (a) A headset consists of a communication device that includes two earphones to receive and a microphone to transmit audio signals to the aeroplane's communication system. To comply with the minimum performance requirements, the earphones and microphone should match the communication system's characteristics and the flight crew compartment environment. The headset should be sufficiently adjustable to fit the pilot's head. Headset boom microphones should be of the noise cancelling type.
- (b) If the intention is to utilise noise cancelling earphones, the operator should ensure that the earphones do not attenuate any aural warnings or sounds necessary for alerting the flight crew on matters related to the safe operation of the aeroplane.

GM1 CAT.IDE.A.325 Headset

GENERAL

The term 'headset' includes any aviation helmet incorporating headphones and microphone worn by a flight crew member.

CAT.IDE.A.330 Radio communication equipment

- (a) Aeroplanes shall be equipped with the radio communication equipment required by the applicable airspace requirements.
- (b) The radio communication equipment shall provide for communication on the aeronautical emergency frequency 121,5 MHz.

CAT.IDE.A.335 Audio selector panel

Aeroplanes operated under IFR shall be equipped with an audio selector panel operable from each required flight crew member station.

CAT.IDE.A.340 Radio equipment for operations under VFR over routes navigated by reference to visual landmarks

Aeroplanes operated under VFR over routes navigated by reference to visual landmarks shall be equipped with radio communication equipment necessary under normal radio propagation conditions to fulfil the following:

- (a) communicate with appropriate ground stations;
- (b) communicate with appropriate ATC stations from any point in controlled airspace within which flights are intended; and
- (c) receive meteorological information.

CAT.IDE.A.345 Communication and navigation equipment for operations under IFR or under VFR over routes not navigated by reference to visual landmarks

- (a) Aeroplanes operated under IFR or under VFR over routes that cannot be navigated by reference to visual landmarks shall be equipped with radio communication and navigation equipment in accordance with the applicable airspace requirements.
- (b) Radio communication equipment shall include at least two independent radio communication systems necessary under normal operating conditions to communicate with an appropriate ground station from any point on the route, including diversions.
- (c) Notwithstanding (b), aeroplanes operated for short haul operations in the North Atlantic minimum navigation performance specifications (NAT MNPS) airspace and not crossing the North Atlantic shall be equipped with at least one long range communication system, in case alternative communication procedures are published for the airspace concerned.
- (d) Aeroplanes shall have sufficient navigation equipment to ensure that, in the event of the failure of one item of equipment at any stage of the flight, the remaining equipment shall allow safe navigation in accordance with the flight plan.
- (e) Aeroplanes operated on flights in which it is intended to land in IMC shall be equipped with suitable equipment capable of providing guidance to a point from which a visual landing can be performed for each aerodrome at which it is intended to land in IMC and for any designated alternate aerodrome.
- (f) For PBN operations the aircraft shall meet the airworthiness certification requirements for the appropriate navigation specification.

AMC1 CAT.IDE.A.345 Communication and navigation equipment for operations under IFR or under VFR over routes not navigated by reference to visual landmarks

TWO INDEPENDENT MEANS OF COMMUNICATION

Whenever two independent means of communication are required, each system should have an independent antenna installation, except where rigidly supported non-wire antennae or other antenna installations of equivalent reliability are used.

AMC2 CAT.IDE.A.345 Communication and navigation equipment for operations under IFR or under VFR over routes not navigated by reference to visual landmarks

ACCEPTABLE NUMBER AND TYPE OF COMMUNICATION AND NAVIGATION EQUIPMENT

- (a) An acceptable number and type of communication and navigation equipment is:
- (1) one VHF omnidirectional radio range (VOR) receiving system, one automatic direction finder (ADF) system, one distance measuring equipment (DME), except that an ADF system need not be installed provided that the use of ADF is not required in any phase of the planned flight;
 - (2) one instrument landing system (ILS) or microwave landing system (MLS) where ILS or MLS is required for approach navigation purposes;
 - (3) one marker beacon receiving system where a marker beacon is required for approach navigation purposes;
 - (4) area navigation equipment when area navigation is required for the route being flown (e.g. equipment required by Part-SPA);
 - (5) an additional DME system on any route, or part thereof, where navigation is based only on DME signals;
 - (6) an additional VOR receiving system on any route, or part thereof, where navigation is based only on VOR signals; and
 - (7) an additional ADF system on any route, or part thereof, where navigation is based only on non-directional beacon (NDB) signals.
- (b) Aeroplanes may be operated without the navigation equipment specified in (6) and (7) provided they are equipped with alternative equipment. The reliability and the accuracy of alternative equipment should allow safe navigation for the intended route.
- (c) The operator conducting extended range operations with two-engined aeroplanes (ETOPS) should ensure that the aeroplanes have a communication means capable of communicating with an appropriate ground station at normal and planned contingency altitudes. For ETOPS routes where voice communication facilities are available, voice communications should be provided. For all ETOPS operations beyond 180 minutes, reliable communication technology, either voice-based or data link, should be installed. Where voice communication facilities are not available and where voice communication is not possible or is of poor quality, communications using alternative systems should be ensured.
- (d) To perform IFR operations without an ADF system installed, the operator should consider the following guidelines on equipment carriage, operational procedures and training criteria.
- (1) ADF equipment may only be removed from or not installed in an aeroplane intended to be used for IFR operations when it is not essential for navigation, and provided that alternative equipment giving equivalent or enhanced navigation capability is carried. This may be

- accomplished by the carriage of an additional VOR receiver or a GNSS receiver approved for IFR operations.
- (2) For IFR operations without ADF, the operator should ensure that:
- (i) route segments that rely solely on ADF for navigation are not flown;
 - (ii) ADF/NDB procedures are not flown;
 - (iii) the minimum equipment list (MEL) has been amended to take account of the non-carriage of ADF;
 - (iv) the operations manual does not refer to any procedures based on NDB signals for the aeroplanes concerned; and
 - (v) flight planning and dispatch procedures are consistent with the above mentioned criteria.
- (3) The removal of ADF should be taken into account by the operator in the initial and recurrent training of flight crew.
- (e) VHF communication equipment, ILS localiser and VOR receivers installed on aeroplanes to be operated in IFR should comply with the following FM immunity performance standards:
- (1) ICAO Annex 10, Volume I - Radio Navigation Aids, and Volume III, Part II - Voice Communications Systems; and
 - (2) acceptable equipment standards contained in EUROCAE Minimum Operational Performance Specifications, documents ED-22B for VOR receivers, ED-23B for VHF communication receivers and ED-46B for LOC receivers and the corresponding Radio Technical Commission for Aeronautics (RTCA) documents DO-186, DO-195 and DO-196.

AMC3 CAT.IDE.A.345 Communication and navigation equipment for operations under IFR or under VFR over routes not navigated by reference to visual landmarks

FAILURE OF A SINGLE UNIT

Required communication and navigation equipment should be installed such that the failure of any single unit required for either communication or navigation purposes, or both, will not result in the failure of another unit required for communications or navigation purposes.

AMC4 CAT.IDE.A.345 Communication and navigation equipment for operations under IFR or under VFR over routes not navigated by reference to visual landmarks

LONG RANGE COMMUNICATION SYSTEMS

- (a) The long range communication system should be either a high frequency/HF-system or another two-way communication system if allowed by the relevant airspace procedures.
- (b) When using one communication system only, the competent authority may restrict the minimum navigation performance specifications (MNPS) approval to the use of the specific routes.

GM1 CAT.IDE.A.345 Communication and navigation equipment for operations under IFR or under VFR over routes not navigated by reference to visual landmarks

APPLICABLE AIRSPACE REQUIREMENTS

For aeroplanes being operated under European air traffic control, the applicable airspace requirements include the Single European Sky legislation.

GM2 CAT.IDE.A.345 Communication and navigation equipment for operations under IFR or under VFR over routes not navigated by reference to visual landmarks

AIRCRAFT ELIGIBILITY FOR PBN SPECIFICATION NOT REQUIRING SPECIFIC APPROVAL

- (a) The performance of the aircraft is usually stated in the AFM.
- (b) Where such a reference cannot be found in the AFM, other information provided by the aircraft manufacturer as TC holder, the STC holder or the design organisation having a privilege to approve minor changes may be considered.
- (c) The following documents are considered acceptable sources of information:
 - (1) AFM, supplements thereto, and documents directly referenced in the AFM;
 - (2) FCOM or similar document;
 - (3) Service Bulletin or Service Letter issued by the TC holder or STC holder;
 - (4) approved design data or data issued in support of a design change approval;
 - (5) any other formal document issued by the TC or STC holders stating compliance with PBN specifications, AMC, Advisory Circulars (AC) or similar documents issued by the State of Design; and
 - (6) written evidence obtained from the State of Design.
- (d) Equipment qualification data, in itself, is not sufficient to assess the PBN capabilities of the aircraft, since the latter depend on installation and integration.
- (e) As some PBN equipment and installations may have been certified prior to the publication of the PBN Manual and the adoption of its terminology for the navigation specifications, it is not always possible to find a clear statement of aircraft PBN capability in the AFM. However, aircraft eligibility for certain PBN specifications can rely on the aircraft performance certified for PBN procedures and routes prior to the publication of the PBN Manual.
- (f) Below, various references are listed which may be found in the AFM or other acceptable documents (see listing above) in order to consider the aircraft's eligibility for a specific PBN specification if the specific term is not used.
- (g) RNAV 5
 - (1) If a statement of compliance with any of the following specifications or standards is found in the acceptable documentation as listed above, the aircraft is eligible for RNAV 5 operations.
 - (i) B-RNAV;
 - (ii) RNAV 1;
 - (iii) RNP APCH;
 - (iv) RNP 4;
 - (v) A-RNP;
 - (vi) AMC 20-4;
 - (vii) JAA TEMPORARY GUIDANCE MATERIAL, LEAFLET NO. 2 (TGL 2);
 - (viii) JAA AMJ 20X2;
 - (ix) FAA AC 20-130A for en route operations;
 - (x) FAA AC 20-138 for en route operations; and

- (xi) FAA AC 90-96.
- (h) RNAV 1/RNAV 2
 - (1) If a statement of compliance with any of the following specifications or standards is found in the acceptable documentation as listed above, the aircraft is eligible for RNAV 1/RNAV 2 operations.
 - (i) RNAV 1;
 - (ii) PRNAV;
 - (iii) US RNAV type A;
 - (iv) FAA AC 20-138 for the appropriate navigation specification;
 - (v) FAA AC 90-100A;
 - (vi) JAA TEMPORARY GUIDANCE MATERIAL, LEAFLET NO. 10 Rev1 (TGL 10); and
 - (vii) FAA AC 90-100.
 - (2) However, if position determination is exclusively computed based on VOR-DME, the aircraft is not eligible for RNAV 1/RNAV 2 operations.
- (i) RNP 1/RNP 2 continental
 - (1) If a statement of compliance with any of the following specifications or standards is found in the acceptable documentation as listed above, the aircraft is eligible for RNP 1/RNP 2 continental operations.
 - (i) A-RNP;
 - (ii) FAA AC 20-138 for the appropriate navigation specification; and
 - (iii) FAA AC 90-105.
 - (2) Alternatively, if a statement of compliance with any of the following specifications or standards is found in the acceptable documentation as listed above and position determination is primarily based on GNSS, the aircraft is eligible for RNP 1/RNP 2 continental operations. However, in these cases, loss of GNSS implies loss of RNP 1/RNP 2 capability.
 - (i) JAA TEMPORARY GUIDANCE MATERIAL, LEAFLET NO. 10 (TGL 10) (any revision); and
 - (ii) FAA AC 90-100.
- (j) RNP APCH — LNAV minima
 - (1) If a statement of compliance with any of the following specifications or standards is found in the acceptable documentation as listed above, the aircraft is eligible for RNP APCH — LNAV operations.
 - (i) A-RNP;
 - (ii) AMC 20-27;
 - (iii) AMC 20-28;
 - (iv) FAA AC 20-138 for the appropriate navigation specification; and
 - (v) FAA AC 90-105 for the appropriate navigation specification.
 - (2) Alternatively, if a statement of compliance with RNP 0.3 GNSS approaches in accordance with any of the following specifications or standards is found in the acceptable

documentation as listed above, the aircraft is eligible for RNP APCH — LNAV operations. Any limitation such as ‘within the US National Airspace’ may be ignored since RNP APCH procedures are assumed to meet the same ICAO criteria around the world.

- (i) JAA TEMPORARY GUIDANCE MATERIAL, LEAFLET NO. 3 (TGL 3);
- (ii) AMC 20-4;
- (iii) FAA AC 20-130A; and
- (iv) FAA AC 20-138.

(k) RNP APCH — LNAV/VNAV minima

(1) If a statement of compliance with any of the following specifications or standards is found in the acceptable documentation as listed above, the aircraft is eligible for RNP APCH — LNAV/VNAV operations.

- (i) A-RNP;
- (ii) AMC 20-27 with Baro VNAV;
- (iii) AMC 20-28;
- (iv) FAA AC 20-138; and
- (v) FAA AC 90-105 for the appropriate navigation specification.

(2) Alternatively, if a statement of compliance with FAA AC 20-129 is found in the acceptable documentation as listed above, and the aircraft complies with the requirements and limitations of EASA SIB 2014-049, the aircraft is eligible for RNP APCH — LNAV/VNAV operations. Any limitation such as ‘within the US National Airspace’ may be ignored since RNP APCH procedures are assumed to meet the same ICAO criteria around the world.

(l) RNP APCH — LPV minima

(1) If a statement of compliance with any of the following specifications or standards is found in the acceptable documentation as listed above, the aircraft is eligible for RNP APCH — LPV operations.

- (i) AMC 20-28;
- (ii) FAA AC 20-138 for the appropriate navigation specification; and
- (iii) FAA AC 90-107.

(2) For aircraft that have a TAWS Class A installed and do not provide Mode-5 protection on an LPV approach, the DH is limited to 250 ft.

(m) RNAV 10

(1) If a statement of compliance with any of the following specifications or standards is found in the acceptable documentation as listed above, the aircraft is eligible for RNAV 10 operations.

- (i) RNP 10;
- (ii) FAA AC 20-138 for the appropriate navigation specification;
- (iii) AMC 20-12;

⁹ <http://ad.easa.europa.eu/ad/2014-04>

- (iv) FAA Order 8400.12 (or later revision); and
 - (v) FAA AC 90-105.
- (n) RNP 4
- (1) If a statement of compliance with any of the following specifications or standards is found in the acceptable documentation as listed above, the aircraft is eligible for RNP 4 operations.
 - (i) FAA AC 20-138B or later, for the appropriate navigation specification;
 - (ii) FAA Order 8400.33; and
 - (iii) FAA AC 90-105 for the appropriate navigation specification.
- (o) RNP 2 oceanic
- (1) If a statement of compliance with FAA AC 90-105 for the appropriate navigation specification is found in the acceptable documentation as listed above, the aircraft is eligible for RNP 2 oceanic operations.
 - (2) If the aircraft has been assessed eligible for RNP 4, the aircraft is eligible for RNP 2 oceanic.
- (p) Special features
- (1) RF in terminal operations (used in RNP 1 and in the initial segment of the RNP APCH)
 - (i) If a statement of demonstrated capability to perform an RF leg, certified in accordance with any of the following specifications or standards, is found in the acceptable documentation as listed above, the aircraft is eligible for RF in terminal operations:
 - (A) AMC 20-26; and
 - (B) FAA AC 20-138B or later.
 - (ii) If there is a reference to RF and a reference to compliance with AC 90-105, then the aircraft is eligible for such operations.
- (q) Other considerations
- (1) In all cases, the limitations in the AFM need to be checked; in particular, the use of AP or FD which can be required to reduce the FTE primarily for RNP APCH, RNAV 1, and RNP 1.
 - (2) Any limitation such as 'within the US National Airspace' may be ignored since RNP APCH procedures are assumed to meet the same ICAO criteria around the world.

GM3 CAT.IDE.A.345 Communication and navigation equipment for operations under IFR or under VFR over routes not navigated by reference to visual landmarks

GENERAL

- (a) The PBN specifications for which the aircraft complies with the relevant airworthiness criteria are set out in the AFM, together with any limitations to be observed.
- (b) Because functional and performance requirements are defined for each navigation specification, an aircraft approved for an RNP specification is not automatically approved for all RNAV specifications. Similarly, an aircraft approved for an RNP or RNAV specification having a stringent accuracy requirement (e.g. RNP 0.3 specification) is not automatically approved for a navigation specification having a less stringent accuracy requirement (e.g. RNP 4).

RNP 4

- (c) For RNP 4, at least two LRNSs, capable of navigating to RNP 4, and listed in the AFM, may be operational at the entry point of the RNP 4 airspace. If an item of equipment required for RNP 4 operations is unserviceable, then the flight crew may consider an alternate route or diversion for repairs. For multi-sensor systems, the AFM may permit entry if one GNSS sensor is lost after departure, provided one GNSS and one inertial sensor remain available.

GM1 CAT.IDE.A.345(c) Communication and navigation equipment for operations under IFR or under VFR over routes not navigated by reference to visual landmarks

SHORT HAUL OPERATIONS

The term 'short haul operations' refers to operations not crossing the North Atlantic.

CAT.IDE.A.350 Transponder

Aeroplanes shall be equipped with a pressure altitude reporting secondary surveillance radar (SSR) transponder and any other SSR transponder capability required for the route being flown.

AMC1 CAT.IDE.A.350 Transponder

SSR TRANSPONDER

- (a) The secondary surveillance radar (SSR) transponders of aeroplanes being operated under European air traffic control should comply with any applicable Single European Sky legislation.
- (b) If the Single European Sky legislation is not applicable, the SSR transponders should operate in accordance with the relevant provisions of Volume IV of ICAO Annex 10.

CAT.IDE.A.355 Electronic navigation data management

Applicable until 01/01/2019, then shall be replaced with the version below

- (a) The operator shall only use electronic navigation data products that support a navigation application meeting standards of integrity that are adequate for the intended use of the data.
- (b) When the electronic navigation data products support a navigation application needed for an operation for which Annex V (Part-SPA) requires an approval, the operator shall demonstrate to the competent authority that the process applied and the delivered products meet standards of integrity that are adequate for the intended use of the data.
- (c) The operator shall continuously monitor the integrity of both the process and the products, either directly or by monitoring the compliance of third party providers.
- (d) The operator shall ensure the timely distribution and insertion of current and unaltered electronic navigation data to all aeroplanes that require it.

CAT.IDE.A.355 Management of aeronautical databases

Applicable from 01/01/2019. Will replace the paragraph above.

- (a) Aeronautical databases used on certified aircraft system applications shall meet data quality requirements that are adequate for the intended use of the data.
- (b) The operator shall ensure the timely distribution and insertion of current and unaltered aeronautical databases to all aircraft that require them.
- (c) Notwithstanding any other occurrence reporting requirements as defined in Regulation (EU) No 376/2014, the operator shall report to the database provider instances of erroneous, inconsistent or missing data that might be reasonably expected to constitute a hazard to flight.

In such cases, the operator shall inform flight crew and other personnel concerned, and shall ensure that the affected data is not used.

AMC1 CAT.IDE.A.355 Electronic navigation data management**ELECTRONIC NAVIGATION DATA PRODUCTS**

- (a) When the operator of a complex motor-powered aeroplane uses a navigation database that supports an airborne navigation application as a primary means of navigation, the navigation database supplier should hold a Type 2 letter of acceptance (LoA), or equivalent.
- (b) If this airborne navigation application is needed for an operation requiring a specific approval in accordance with Annex V (Part-SPA), the operator's procedures should be based upon the Type 2 LoA acceptance process.

GM1 CAT.IDE.A.355 Electronic navigation data management**LETTERS OF ACCEPTANCE AND STANDARDS FOR ELECTRONIC NAVIGATION DATA PRODUCTS**

- (a) A Type 2 LoA is issued by the Agency in accordance with the Agency's Opinion No 01/2005 on The Acceptance of Navigation Database Suppliers. The definitions of navigation database, navigation database supplier, data application integrator, Type 1 LoA and Type 2 LoA can be found in Opinion No 01/2005.
- (b) Equivalent to a Type 2 LoA is the FAA Type 2 LoA, issued in accordance with the Federal Aviation Administration (FAA) Advisory Circular AC 20-153 or AC 20-153A, and the Transport Canada Civil Aviation (TCCA) 'Acknowledgement Letter of an Aeronautical Data Process', which uses the same basis.

- (c) EUROCAE ED-76/Radio Technical Commission for Aeronautics (RTCA) DO-200A Standards for Processing Aeronautical Data contains guidance relating to the processes that the supplier may follow.

SECTION 2
Helicopters**CAT.IDE.H.100 Instruments and equipment — general**

- (a) Instruments and equipment required by this Subpart shall be approved in accordance with the applicable airworthiness requirements, except for the following items:
- (1) Spare fuses;
 - (2) Independent portable lights;
 - (3) An accurate time piece;
 - (4) Chart holder;
 - (5) First-aid kit;
 - (6) Megaphones;
 - (7) Survival and signalling equipment;
 - (8) Sea anchors and equipment for mooring; and
 - (9) Child restraint devices.
- (b) Instruments and equipment not required by this Subpart that do not need to be approved in accordance with the applicable airworthiness requirements but are carried on a flight, shall comply with the following:
- (1) the information provided by these instruments, equipment or accessories shall not be used by the flight crew to comply with Annex 1 to Regulation (EC) No 216/2008 or CAT.IDE.H.330, CAT.IDE.H.335, CAT.IDE.H.340 and CAT.IDE.H.345; and
 - (2) the instruments and equipment shall not affect the airworthiness of the helicopter, even in the case of failures or malfunction.
- (c) If equipment is to be used by one flight crew member at his/her station during flight, it shall be readily operable from that station. When a single item of equipment is required to be operated by more than one flight crew member it shall be installed so that the equipment is readily operable from any station at which the equipment is required to be operated.
- (d) Those instruments that are used by any flight crew member shall be so arranged as to permit the flight crew member to see the indications readily from his/her station, with the minimum practicable deviation from the position and line of vision that he/she normally assumes when looking forward along the flight path.
- (e) All required emergency equipment shall be easily accessible for immediate use.

GM1 CAT.IDE.H.100(a) Instruments and equipment — general

REQUIRED INSTRUMENTS AND EQUIPMENT THAT DO NOT NEED TO BE APPROVED IN ACCORDANCE WITH COMMISSION REGULATION (EU) NO 748/2012

The functionality of non-installed instruments and equipment required by this Subpart and that do not need an equipment approval, as listed in CAT.IDE.H.100(a), should be checked against recognised industry standards appropriate to the intended purpose. The operator is responsible for ensuring the maintenance of these instruments and equipment.

GM1 CAT.IDE.H.100(b) Instruments and equipment — general

NOT REQUIRED INSTRUMENTS AND EQUIPMENT THAT DO NOT NEED TO BE APPROVED IN ACCORDANCE WITH COMMISSION REGULATION (EU) NO 748/2012, BUT ARE CARRIED ON A FLIGHT

- (a) The provision of this paragraph does not exempt any installed instrument or item of equipment from complying with Commission Regulation (EU) No 748/2012. In this case, the installation should be approved as required in Commission Regulation (EU) No 748/2012 and should comply with the applicable Certification Specifications as required under that Regulation.
- (b) The failure of additional non-installed instruments or equipment not required by this Part or the Certification Specifications as required under Commission Regulation (EU) No 748/2012 or any applicable airspace requirements should not adversely affect the airworthiness and/or the safe operation of the aircraft. Examples may be the following:
 - (1) portable electronic flight bag (EFB);
 - (2) portable electronic devices carried by flight crew or cabin crew; and
 - (3) non-installed passenger entertainment equipment.

GM1 CAT.IDE.H.100(d) Instruments and equipment — general**POSITIONING OF INSTRUMENTS**

This requirement implies that whenever a single instrument is required to be installed in a helicopter operated in a multi-crew environment, the instrument needs to be visible from each flight crew station.

CAT.IDE.H.105 Minimum equipment for flight

A flight shall not be commenced when any of the helicopter's instruments, items of equipment or functions required for the intended flight are inoperative or missing, unless:

- (a) the helicopter is operated in accordance with the operator's MEL; or
- (b) the operator is approved by the competent authority to operate the helicopter within the constraints of the MMEL.

CAT.IDE.H.115 Operating lights

- (a) Helicopters operated under VFR by day shall be equipped with an anti-collision light system.
- (b) Helicopters operated at night or under IFR shall, in addition to (a), be equipped with:
 - (1) lighting supplied from the helicopter's electrical system to provide adequate illumination for all instruments and equipment essential to the safe operation of the helicopter;
 - (2) lighting supplied from the helicopter's electrical system to provide illumination in all passenger compartments;
 - (3) an independent portable light for each required crew member readily accessible to crew members when seated at their designated stations;
 - (4) navigation/position lights;
 - (5) two landing lights of which at least one is adjustable in flight so as to illuminate the ground in front of and below the helicopter and the ground on either side of the helicopter; and
 - (6) lights to conform with the International Regulations for Preventing Collisions at Sea if the helicopter is amphibious.

CAT.IDE.H.125 Operations under VFR by day — flight and navigational instruments and associated equipment

- (a) Helicopters operated under VFR by day shall be equipped with the following equipment, available at the pilot's station:
 - (1) A means of measuring and displaying:
 - (i) Magnetic heading;
 - (ii) Time in hours, minutes, and seconds;
 - (iii) Pressure altitude;
 - (iv) Indicated airspeed;
 - (v) Vertical speed;
 - (vi) Slip; and
 - (vii) Outside air temperature.
 - (2) A means of indicating when the supply of power to the required flight instruments is not adequate.
- (b) Whenever two pilots are required for the operation, an additional separate means of displaying the following shall be available for the second pilot:
 - (1) Pressure altitude;
 - (2) Indicated airspeed;

- (3) Vertical speed; and
- (4) Slip.
- (c) Helicopters with an MCTOM of more than 3 175 kg or any helicopter operating over water when out of sight of land or when the visibility is less than 1500 m, shall be equipped with a means of measuring and displaying:
 - (1) Attitude; and
 - (2) Heading.
- (d) A means for preventing malfunction of the airspeed indicating systems due to condensation or icing shall be available for helicopters with an MCTOM of more than 3 175 kg or an MOPSC of more than nine.

AMC1 CAT.IDE.H.125 & CAT.IDE.H.130 Operations under VFR by day & Operations under IFR or at night — flight and navigational instruments and associated equipment

INTEGRATED INSTRUMENTS

- (a) Individual equipment requirements may be met by combinations of instruments or by integrated flight systems or by a combination of parameters on electronic displays, provided that the information so available to each required pilot is not less than the required in the applicable operational requirements, and the equivalent safety of the installation has been shown during type certification approval of the helicopter for the intended type of operation.
- (b) The means of measuring and indicating slip, helicopter attitude and stabilised helicopter heading may be met by combinations of instruments or by integrated flight director systems, provided that the safeguards against total failure, inherent in the three separate instruments, are retained.

AMC1 CAT.IDE.H.125(a)(1)(i) & CAT.IDE.H.130(a)(1) Operations under VFR by day & Operations under IFR or at night — flight and navigational instruments and associated equipment

MEANS OF MEASURING AND DISPLAYING MAGNETIC HEADING

The means of measuring and displaying magnetic direction should be a magnetic compass or equivalent.

AMC1 CAT.IDE.H.125(a)(1)(ii) & CAT.IDE.H.130(a)(2) Operations under VFR by day & Operations under IFR or at night — flight and navigational instruments and associated equipment

MEANS OF MEASURING AND DISPLAYING THE TIME

An acceptable means of compliance is a clock displaying hours, minutes and seconds, with a sweep-second pointer or digital presentation.

AMC1 CAT.IDE.H.125(a)(1)(iii) & CAT.IDE.H.130(b) Operations under VFR by day & Operations under IFR or at night — flight and navigational instruments and associated equipment

CALIBRATION OF THE MEANS OF MEASURING AND DISPLAYING PRESSURE ALTITUDE

The instrument measuring and displaying pressure altitude should be of a sensitive type calibrated in feet (ft), with a sub-scale setting, calibrated in hectopascals/millibars, adjustable for any barometric pressure likely to be set during flight.

AMC1 CAT.IDE.H.125(a)(1)(iv) & CAT.IDE.H.130(a)(3) Operations under VFR by day & Operations under IFR or at night — flight and navigational instruments and associated equipment

CALIBRATION OF THE INSTRUMENT INDICATING AIRSPEED

The instrument indicating airspeed should be calibrated in knots (kt).

AMC1 CAT.IDE.H.125(a)(1)(vii) & CAT.IDE.H.130(a)(8) Operations under VFR by day & Operations under IFR or at night — flight and navigational instruments and associated equipment

OUTSIDE AIR TEMPERATURE

- (a) The means of displaying outside air temperature should be calibrated in degrees Celsius.
- (b) The means of displaying outside air temperature may be an air temperature indicator that provides indications that are convertible to outside air temperature.

AMC1 CAT.IDE.H.125(b) & CAT.IDE.H.130(h) Operations under VFR by day & Operations under IFR or at night — flight and navigational instruments and associated equipment

MULTI-PILOT OPERATIONS — DUPLICATE INSTRUMENTS

Duplicate instruments should include separate displays for each pilot and separate selectors or other associated equipment where appropriate.

AMC1 CAT.IDE.H.125(c)(2) & CAT.IDE.H.130(a)(7) Operations under VFR by day & Operations under IFR or at night — flight and navigational instruments and associated equipment

STABILISED HEADING

Stabilised heading should be achieved for VFR flights by a gyroscopic heading indicator, whereas for IFR flights, this should be achieved through a magnetic gyroscopic heading indicator.

AMC1 CAT.IDE.H.125(d) & CAT.IDE.H.130(d) Operations under VFR by day & Operations under IFR or at night operations — flight and navigational instruments and associated equipment

MEANS OF PREVENTING MALFUNCTION DUE TO CONDENSATION OR ICING

The means of preventing malfunction due to either condensation or icing of the airspeed indicating system should be a heated pitot tube or equivalent.

GM1 CAT.IDE.H.125 & CAT.IDE.H.130 Operations under VFR by day & Operations under IFR or at night — flight and navigational instruments and associated equipment

See [here](#).

CAT.IDE.H.130 Operations under IFR or at night — flight and navigational instruments and associated equipment

Helicopters operated under VFR at night or under IFR shall be equipped with the following equipment, available at the pilot's station:

- (a) A means of measuring and displaying:
 - (1) Magnetic heading;
 - (2) Time in hours, minutes and seconds;
 - (3) Indicated airspeed;
 - (4) Vertical speed;
 - (5) Slip;
 - (6) Attitude;
 - (7) Stabilised heading; and
 - (8) Outside air temperature.
- (b) Two means of measuring and displaying pressure altitude. For single-pilot operations under VFR at night one pressure altimeter may be substituted by a radio altimeter.
- (c) A means of indicating when the supply of power to the required flight instruments is not adequate.
- (d) A means of preventing malfunction of the airspeed indicating systems required in (a)(3) and (h)(2) due to either condensation or icing.
- (e) A means of annunciating to the flight crew the failure of the means required in (d) for helicopters:
 - (1) issued with an individual CofA on or after 1 August 1999; or
 - (2) issued with an individual CofA before 1 August 1999 with an MCTOM of more than 3 175 kg, and with an MOPSC of more than nine.
- (f) A standby means of measuring and displaying attitude that:
 - (1) is powered continuously during normal operation and, in the event of a total failure of the normal electrical generating system, is powered from a source independent of the normal electrical generating system;
 - (2) operates independently of any other means of measuring and displaying attitude;
 - (3) is capable of being used from either pilot's station;
 - (4) is operative automatically after total failure of the normal electrical generating system;
 - (5) provides reliable operation for a minimum of 30 minutes or the time required to fly to a suitable alternate landing site when operating over hostile terrain or offshore, whichever is greater, after total failure of the normal electrical generating system, taking into account other loads on the emergency power supply and operational procedures;
 - (6) is appropriately illuminated during all phases of operation; and
 - (7) is associated with a means to alert the flight crew when operating under its dedicated power supply, including when operated by emergency power.
- (g) An alternate source of static pressure for the means of measuring altitude, airspeed and vertical speed.

- (h) Whenever two pilots are required for the operation, a separate means for displaying for the second pilot:
- (1) Pressure altitude;
 - (2) Indicated airspeed;
 - (3) Vertical speed;
 - (4) Slip;
 - (5) Attitude; and
 - (6) Stabilised heading.
- (i) For IFR operations, a chart holder in an easily readable position that can be illuminated for night operations.

AMC1 CAT.IDE.H.125 & CAT.IDE.H.130 Operations under VFR by day & Operations under IFR or at night — flight and navigational instruments and associated equipment

See [here](#).

AMC1 CAT.IDE.H.125(a)(1)(i) & CAT.IDE.H.130(a)(1) Operations under VFR by day & Operations under IFR or at night — flight and navigational instruments and associated equipment

See [here](#).

AMC1 CAT.IDE.H.125(a)(1)(ii) & CAT.IDE.H.130(a)(2) Operations under VFR by day & Operations under IFR or at night — flight and navigational instruments and associated equipment

See [here](#).

AMC1 CAT.IDE.H.125(a)(1)(iii) & CAT.IDE.H.130(b) Operations under VFR by day & Operations under IFR or at night — flight and navigational instruments and associated equipment

See [here](#).

AMC1 CAT.IDE.H.125(a)(1)(iv) & CAT.IDE.H.130(a)(43) Operations under VFR by day & Operations under IFR or at night — flight and navigational instruments and associated equipment

See [here](#).

AMC1 CAT.IDE.H.125(a)(1)(vii) & CAT.IDE.H.130(a)(8) Operations under VFR by day & Operations under IFR or at night — flight and navigational instruments and associated equipment

See [here](#).

AMC1 CAT.IDE.H.125(b) & CAT.IDE.H.130(h) Operations under VFR by day & Operations under IFR or at night — flight and navigational instruments and associated equipment

See [here](#).

AMC1 CAT.IDE.H.125(c)(2) & CAT.IDE.H.130(a)(7) Operations under VFR by day & Operations under IFR or at night — flight and navigational instruments and associated equipment

See [here](#).

AMC1 CAT.IDE.H.125(d) & CAT.IDE.H.130(d) Operations under VFR by day & Operations under IFR or at night operations — flight and navigational instruments and associated equipment

See [here](#).

AMC1 CAT.IDE.H.130(e) Operations under IFR or at night — flight and navigational instruments and associated equipment

MEANS OF INDICATING FAILURE OF THE AIRSPEED INDICATING SYSTEM'S MEANS OF PREVENTING MALFUNCTION DUE TO EITHER CONDENSATION OR ICING

A combined means of indicating failure of the airspeed indicating system's means of preventing malfunction due to either condensation or icing is acceptable provided that it is visible from each flight crew station and that there it is a means to identify the failed heater in systems with two or more sensors.

AMC1 CAT.IDE.H.130(f)(6) Operations under IFR or at night — flight and navigational instruments and associated equipment

ILLUMINATION OF STANDBY MEANS OF MEASURING AND DISPLAYING ATTITUDE

The standby means of measuring and displaying attitude should be illuminated so as to be clearly visible under all conditions of daylight and artificial lighting.

AMC1 CAT.IDE.H.130(i) Operations under IFR or at night — flight and navigational instruments and associated equipment

CHART HOLDER

An acceptable means of compliance with the chart holder requirement is to display a pre-composed chart on an electronic flight bag (EFB).

**GM1 CAT.IDE.H.125 & CAT.IDE.H.130 Operations under VFR by day & Operations under IFR or at night
— flight and navigational instruments and associated equipment**

SUMMARY TABLE

Table 1

Flight and navigational instruments and associated equipment

SERIAL		FLIGHTS UNDER VFR		FLIGHTS UNDER IFR OR AT NIGHT	
INSTRUMENT		SINGLE-PILOT	TWO PILOTS REQUIRED	SINGLE-PILOT	TWO PILOTS REQUIRED
(a)		(b)	(c)	(d)	(e)
1	Magnetic direction	1	1	1	1
2	time	1	1	1	1
3	Pressure altitude	1	2	2 Note (1)	2
4	Indicated airspeed	1	2	1	2
5	Vertical speed	1	2	1	2
6	Slip	1	2	1	2
7	Attitude	1 Note (2)	2 Note(2)	1	2
8	Stabilised direction	1 Note (2)	2 Note(2)	1	2
9	Outside air temperature	1	1	1	1
10	Airspeed icing protection	1 Note (3)	2 Note (3)	1	2
11	Airspeed icing protection failure indicating			1 Note (4)	2 Note (4)
12	Static pressure source			2	2
13	Standby attitude			1 Note (5)	1 Note (5)
14	Chart holder			1 Note (6)	1 Note (6)

Note (1) For single-pilot night operation under VFR, one means of measuring and displaying pressure altitude may be substituted by a means of measuring and displaying radio altitude.

Note (2) Applicable only to helicopters with a maximum certified take-off mass (MCTOM) of more than 3 175 kg; or helicopters operated over water when out of sight of land or when the visibility is less than 1 500 m.

-
- Note (3) Applicable only to helicopters with an MCTOM of more than 3 175 kg, or with an MOPSC of more than 9.
- Note (4) The pitot heater failure annunciation applies to any helicopter issued with an individual CofA on or after 1 August 1999. It also applies before that date when: the helicopter has a MCTOM of more than 3 175 kg and an MOPSC of more than 9.
- Note (5) For helicopters with an MCTOM of more than 3 175 kg, CS 29.1303(g) may require either a gyroscopic rate-of-turn indicator combined with a slip-skid indicator (turn and bank indicator) or a standby attitude indicator satisfying the requirements. In any case, the original type certification standard should be referred to determine the exact requirement.
- Note (6) Applicable only to helicopters operating under IFR.

CAT.IDE.H.135 Additional equipment for single-pilot operation under IFR

Helicopters operated under IFR with a single-pilot shall be equipped with an autopilot with at least altitude hold and heading mode.

CAT.IDE.H.145 Radio altimeters

- (a) Helicopters on flights over water shall be equipped with a radio altimeter capable of emitting an audio warning below a pre-set height and a visual warning at a height selectable by the pilot, when operating:
- (1) out of sight of the land;
 - (2) in a visibility of less than 1 500 m;
 - (3) at night; or
 - (4) at a distance from land corresponding to more than three minutes at normal cruising speed.

AMC1 CAT.IDE.H.145 Radio altimeters

AUDIO WARNING DEVICE

The audio warning required in CAT.IDE.H.145 should be a voice warning.

Applicable until 01/07/2018, then replaced by the AMC below.

AMC1 CAT.IDE.H.145 Radio altimeters

AUDIO WARNING DEVICE

- (a) The audio warning should be a voice warning.
- (b) The audio warning may be provided by a helicopter terrain awareness and warning system (HTAWS).

Applicable from 01/07/2018. Will replace the AMC above.

AMC2 CAT.IDE.H.145 Radio altimeters

RADIO ALTIMETER DISPLAY

The radio altimeter should be of an analogue type display presentation that requires minimal interpretation for both an instantaneous impression of absolute height and rate of change of height.

Applicable from 01/07/2018.

GM1 CAT.IDE.H.145 Radio altimeters

AUDIO-VOICE-ALERTING DEVICE

- (a) To be effective, the voice warning alert should be distinguishable from other warnings and should contain a clear and concise voice message.
- (b) The warning format should meet the following conditions:
- (1) the warning should be unique (i.e. voice);
 - (2) it should not be inhibited by any other audio warnings, except by higher priority alerts such as helicopter terrain awareness and warning system (HTAWS); and
 - (3) the urgency of the warning should be adequate to draw attention but not such as to cause undue annoyance during deliberate descents through the datum height.

Applicable from 01/07/2018.

- (c) The criteria above can be satisfactorily met if the warning format incorporates all of the following features:
- (1) a unique tone should precede the voice message; a further tone after the voice may enhance uniqueness and attract more attention without causing undue annoyance;
 - (2) the perceived tone and voice should be moderately urgent;
 - (3) the message should be compact as opposed to lengthy provided that the meaning is not compromised, e.g. 'One fifty feet' as opposed to 'One hundred and fifty feet';
 - (4) an information message is preferable (e.g. 'One hundred feet'); messages such as 'Low height' do not convey the correct impression during deliberate descents through the datum height;
 - (5) command messages (e.g. 'Pull up, pull up') should not be used unless they relate specifically to height monitoring (e.g. 'Check height'); and
 - (6) the volume of the warning should be adequate and not variable below an acceptable minimum value.
- (d) Every effort should be made to prevent spurious warnings.
- (e) The height at which the audio warning is triggered by the radio altimeter should be such as to provide adequate warning for the pilot to take corrective action. It is envisaged that most installations will adopt a height in the range of 100–160 ft. The datum should not be adjustable in flight.
- (f) The preset datum height should not be set in a way that it coincides with commonly used instrument approach minima (i.e. 200 ft). Once triggered, the message should sound within 0.5 sec.
- (g) The voice warning should be triggered only whilst descending through the preset datum height and be inhibited whilst ascending.

GM2 CAT.IDE.H.145 Radio altimeters**RADIO ALTIMETER DISPLAY**

An analogue type display presentation may be, for example, a representation of a dial, ribbon or bar, but not a display that provides numbers only. An analogue type display may be embedded into an electronic flight instrument system (EFIS).

Applicable
from
01/07/2018.

CAT.IDE.H.160 Airborne weather detecting equipment

Helicopters with an MOPSC of more than nine and operated under IFR or at night shall be equipped with airborne weather detecting equipment when current weather reports indicate that thunderstorms or other potentially hazardous weather conditions, regarded as detectable with airborne weather detecting equipment, may be expected to exist along the route to be flown.

AMC1 CAT.IDE.H.160 Airborne weather detecting equipment**GENERAL**

The airborne weather detecting equipment should be an airborne weather radar.

CAT.IDE.H.165 Additional equipment for operations in icing conditions at night

- (a) Helicopters operated in expected or actual icing conditions at night shall be equipped with a means to illuminate or detect the formation of ice.
- (b) The means to illuminate the formation of ice shall not cause glare or reflection that would handicap crew members in the performance of their duties.

CAT.IDE.H.170 Flight crew interphone system

Helicopters operated by more than one flight crew member shall be equipped with a flight crew interphone system, including headsets and microphones for use by all flight crew members.

AMC1 CAT.IDE.H.170 Flight crew interphone system

TYPE OF FLIGHT CREW INTERPHONE

The flight crew interphone system should not be of a handheld type.

CAT.IDE.H.175 Crew member interphone system

Helicopters shall be equipped with a crew member interphone system when carrying a crew member other than a flight crew member.

AMC1 CAT.IDE.H.175 Crew member interphone system

SPECIFICATIONS

The crew member interphone system should:

- (a) operate independently of the public address system except for handsets, headsets, microphones, selector switches and signalling devices;
- (b) in the case of helicopters where at least one cabin crew member is required, be readily accessible for use at required cabin crew stations close to each separate or pair of floor level emergency exits;
- (c) in the case of helicopters where at least one cabin crew member is required, have an alerting system incorporating aural or visual signals for use by flight and cabin crew;
- (d) have a means for the recipient of a call to determine whether it is a normal call or an emergency call that uses one or a combination of the following:
 - (1) lights of different colours;
 - (2) codes defined by the operator (e.g. different number of rings for normal and emergency calls); or
 - (3) any other indicating signal specified in the operations manual;
- (e) provide a means of two-way communication between the flight crew compartment and each crew member station; and
- (f) be readily accessible for use from each required flight crew station in the flight crew compartment.

CAT.IDE.H.180 Public address system

- (a) Helicopters with an MOPSC of more than nine shall be equipped with a public address system, with the exception of (b).
- (b) Notwithstanding (a) helicopters with an MOPSC of more than nine and less than 20 are exempted from having a public address system, if:
 - (1) the helicopter is designed without a bulkhead between pilot and passengers; and
 - (2) the operator is able to demonstrate that when in flight, the pilot's voice is audible and intelligible at all passengers' seats.

AMC1 CAT.IDE.H.180 Public address system

SPECIFICATIONS

The public address system should:

- (a) operate independently of the interphone systems except for handsets, headsets, microphones, selector switches and signalling devices;
- (b) be readily accessible for immediate use from each required flight crew station;
- (c) have, for each floor level passenger emergency exit that has an adjacent cabin crew seat, a microphone operable by the seated cabin crew member, except that one microphone may serve more than one exit, provided the proximity of exits allows unassisted verbal communication between seated cabin crew members;
- (d) be operable within ten seconds by a cabin crew member at each of those stations;
- (e) be audible at all passenger seats, lavatories, cabin crew seats and work stations and any other location or compartment that may be occupied by persons; and
- (f) following a total failure of the normal electrical generating system, provide reliable operation for a minimum of ten minutes.

CAT.IDE.H.185 Cockpit voice recorder

- (a) The following helicopter types shall be equipped with a cockpit voice recorder (CVR):
- (1) all helicopters with an MCTOM of more than 7 000 kg; and
 - (2) helicopters with an MCTOM of more than 3 175 kg and first issued with an individual CofA on or after 1 January 1987.
- (b) The CVR shall be capable of retaining the data recorded during at least:
- (1) the preceding two hours for helicopters referred to in (a)(1) and (a)(2), when first issued with an individual CofA on or after 1 January 2016;
 - (2) the preceding one hour for helicopters referred to in (a)(1), when first issued with an individual CofA on or after 1 August 1999 and before 1 January 2016;
 - (3) the preceding 30 minutes for helicopters referred to in (a)(1), when first issued with an individual CofA before 1 August 1999; or
 - (4) the preceding 30 minutes for helicopters referred to in (a)(2), when first issued with an individual CofA before 1 January 2016.
- (c) By 1 January 2019 at the latest, the CVR shall record on means other than magnetic tape or magnetic wire.
- (d) The CVR shall record with reference to a timescale:
- (1) voice communications transmitted from or received in the flight crew compartment by radio;
 - (2) flight crew members' voice communications using the interphone system and the public address system, if installed;
 - (3) the aural environment of the flight crew compartment, including without interruption:
 - (i) for helicopters first issued with an individual CofA on or after 1 August 1999, the audio signals received from each crew microphone;
 - (ii) for helicopters first issued with an individual CofA before 1 August 1999, the audio signals received from each crew microphone, where practicable;
 - (4) voice or audio signals identifying navigation or approach aids introduced into a headset or speaker.
- (e) The CVR shall start to record prior to the helicopter moving under its own power and shall continue to record until the termination of the flight when the helicopter is no longer capable of moving under its own power.
- (f) In addition to (e), for helicopters referred to in (a)(2) issued with an individual CofA on or after 1 August 1999:
- (1) the CVR shall start automatically to record prior to the helicopter moving under its own power and continue to record until the termination of the flight when the helicopter is no longer capable of moving under its own power; and
 - (2) depending on the availability of electrical power, the CVR shall start to record as early as possible during the cockpit checks prior to engine start at the beginning of the flight until the cockpit checks immediately following engine shutdown at the end of the flight.
- (g) If the CVR is not deployable, it shall have a device to assist in locating it under water. By 1 January 2020 at the latest, this device shall have a minimum underwater transmission time of 90 days. If the CVR is deployable, it shall have an automatic emergency locator transmitter.

AMC1 CAT.IDE.H.185 Cockpit voice recorder

OPERATIONAL PERFORMANCE REQUIREMENTS

- (a) For helicopters first issued with an individual CofA on or after 1 January 2016, the operational performance requirements for cockpit voice recorders (CVRs) should be those laid down in EUROCAE Document ED-112 Minimum Operational Performance Specification for Crash Protected Airborne Recorder Systems dated March 2003, including Amendments No 1 and No 2, or any later equivalent standard produced by EUROCAE; and
- (b) the operational performance requirements for equipment dedicated to the CVR should be those laid down in the European Organisation for Civil Aviation Equipment (EUROCAE) Document ED-56A (Minimum Operational Performance Requirements For Cockpit Voice Recorder Systems) dated December 1993, or EUROCAE Document ED-112 (Minimum Operational Performance Specification for Crash Protected Airborne Recorder Systems) dated March 2003, including Amendments No°1 and No°2, or any later equivalent standard produced by EUROCAE.

CAT.IDE.H.190 Flight data recorder

- (a) The following helicopters shall be equipped with an FDR that uses a digital method of recording and storing data and for which a method of readily retrieving that data from the storage medium is available:
- (1) helicopters with an MCTOM of more than 3 175 kg and first issued with an individual CofA on or after 1 August 1999;
 - (2) helicopters with an MCTOM of more than 7 000 kg, or an MOPSC of more than nine, and first issued with an individual CofA on or after 1 January 1989 but before 1 August 1999.
- (b) The FDR shall record the parameters required to determine accurately the:
- (1) flight path, speed, attitude, engine power, operation and configuration and be capable of retaining the data recorded during at least the preceding 10 hours, for helicopters referred to in (a)(1) and first issued with an individual CofA on or after 1 January 2016;
 - (2) flight path, speed, attitude, engine power and operation and be capable of retaining the data recorded during at least the preceding eight hours, for helicopters referred to in (a)(1) and first issued with an individual CofA before 1 January 2016;
 - (3) flight path, speed, attitude, engine power and operation and be capable of retaining the data recorded during at least the preceding five hours, for helicopters referred to in (a)(2).
- (c) Data shall be obtained from helicopter sources that enable accurate correlation with information displayed to the flight crew.
- (d) The FDR shall automatically start to record the data prior to the helicopter being capable of moving under its own power and shall stop automatically after the helicopter is incapable of moving under its own power.
- (e) If the FDR is not deployable, it shall have a device to assist in locating it under water. By 1 January 2020 at the latest, this device shall have a minimum underwater transmission time of 90 days. If the FDR is deployable, it shall have an automatic emergency locator transmitter.

AMC1.1 CAT.IDE.H.190 Flight data recorder

OPERATIONAL PERFORMANCE REQUIREMENTS FOR HELICOPTERS HAVING AN MCTOM OF MORE THAN 3 175 KG AND FIRST ISSUED WITH AN INDIVIDUAL CofA ON OR AFTER 1 JANUARY 2016 AND BEFORE 1 JANUARY 2023

- (a) The operational performance requirements for flight data recorders (FDRs) should be those laid down in EUROCAE Document ED-112 (Minimum Operational Performance Specification for Crash Protected Airborne Recorder Systems) dated March 2003, including amendments No 1 and No 2, or any later equivalent standard produced by EUROCAE.
- (b) The FDR should, with reference to a timescale, record:
- (1) the parameters listed in Table 1 below;
 - (2) the additional parameters listed in Table 2 below, when the information data source for the parameter is used by helicopter systems or is available on the instrument panel for use by the flight crew to operate the helicopter; and
 - (3) any dedicated parameters related to novel or unique design or operational characteristics of the helicopter as determined by the Agency.
- (c) The FDR parameters should meet, as far as practicable, the performance specifications (range, sampling intervals, accuracy limits and minimum resolution in read-out) defined in the operational

performance requirements and specifications of EUROCAE Document 112, including amendments No 1 and No 2, or any later equivalent standard produced by EUROCAE.

- (d) FDR systems for which some recorded parameters do not meet the performance specifications of EUROCAE Document ED-112 may be acceptable to the Agency.

Table 1

FDR — all helicopters

No*	Parameter
1	Time or relative time count
2	Pressure altitude
3	Indicated airspeed or calibrated airspeed
4	Heading
5	Normal acceleration
6	Pitch attitude
7	Roll attitude
8	Manual radio transmission keying CVR/FDR synchronisation reference
9	Power on each engine
9a	Free power turbine speed (N_F)
9b	Engine torque
9c	Engine gas generator speed (N_G)
9d	Flight crew compartment power control position
9e	Other parameters to enable engine power to be determined
10	Rotor:
10a	Main rotor speed
10b	Rotor brake (if installed)
11	Primary flight controls — Pilot input and/or control output position (if applicable)
11a	Collective pitch
11b	Longitudinal cyclic pitch
11c	Lateral cyclic pitch
11d	Tail rotor pedal
11e	Controllable stabiliser (if applicable)
11f	Hydraulic selection
12	Hydraulics low pressure (each system should be recorded)

No*	Parameter
13	Outside air temperature
18	Yaw rate or yaw acceleration
20	Longitudinal acceleration (body axis)
21	Lateral acceleration
25	Marker beacon passage
26	Warnings — a discrete should be recorded for the master warning, gearbox low oil pressure and stability augmentation system failure. Other 'red' warnings should be recorded where the warning condition cannot be determined from other parameters or from the cockpit voice recorder.
27	Each navigation receiver frequency selection
37	Engine control modes

* The number in the left hand column reflects the serial numbers depicted in EUROCAE Document ED-112

Table 2

Helicopters for which the data source for the parameter is either used by helicopter systems or is available on the instrument panel for use by the flight crew to operate the helicopter

No*	Parameter
14	AFCS mode and engagement status
15	Stability augmentation system engagement (each system should be recorded)
16	Main gear box oil pressure
17	Gear box oil temperature
17a	Main gear box oil temperature
17b	Intermediate gear box oil temperature
17c	Tail rotor gear box oil temperature
19	Indicated sling load force (if signals readily available)
22	Radio altitude
23	Vertical deviation — the approach aid in use should be recorded.
23a	ILS glide path
23b	MLS elevation
23c	GNSS approach path

No*	Parameter
24	Horizontal deviation — the approach aid in use should be recorded.
24a	ILS localiser
24b	MLS azimuth
24c	GNSS approach path
28	DME 1 & 2 distances
29	Navigation data
29a	Drift angle
29b	Wind speed
29c	Wind direction
29d	Latitude
29e	Longitude
29f	Ground speed
30	Landing gear or gear selector position
31	Engine exhaust gas temperature (T_4)
32	Turbine inlet temperature (TIT/ITT)
33	Fuel contents
34	Altitude rate (vertical speed) — only necessary when available from cockpit instruments
35	Ice detection
36	Helicopter health and usage monitor system (HUMS)
36a	Engine data
36b	Chip detector
36c	Track timing
36d	Exceedance discretets
36e	Broadband average engine vibration
38	Selected barometric setting — to be recorded for helicopters where the parameter is displayed electronically
38a	Pilot
38b	Co-pilot
39	Selected altitude (all pilot selectable modes of operation) — to be recorded for the helicopters where the parameter is displayed electronically

No*	Parameter
40	Selected speed (all pilot selectable modes of operation) — to be recorded for the helicopters where the parameter is displayed electronically
41	Selected Mach (all pilot selectable modes of operation) — to be recorded for the helicopters where the parameter is displayed electronically
42	Selected vertical speed (all pilot selectable modes of operation) — to be recorded for the helicopters where the parameter is displayed electronically
43	Selected heading (all pilot selectable modes of operation) — to be recorded for the helicopters where the parameter is displayed electronically
44	Selected flight path (all pilot selectable modes of operation) — to be recorded for the helicopters where the parameter is displayed electronically
45	Selected decision height (all pilot selectable modes of operation) — to be recorded for the helicopters where the parameter is displayed electronically
46	EFIS display format
47	Multi-function/engine/alerts display format
48	Event marker

* The number in the left hand column reflects the serial numbers depicted in EUROCAE Document ED-112

AMC1.2 CAT.IDE.H.190 Flight data recorder

OPERATIONAL PERFORMANCE REQUIREMENTS FOR HELICOPTERS HAVING AN MCTOM OF MORE THAN 3 175 KG AND FIRST ISSUED WITH AN INDIVIDUAL COFA ON OR AFTER 1 JANUARY 2023

- (a) The operational performance requirements for FDRs should be those laid down in EUROCAE Document 112A (Minimum Operational Performance Specification for Crash Protected Airborne Recorder Systems) dated September 2013, or any later equivalent standard produced by EUROCAE.
- (b) The FDR should, with reference to a timescale, record:
- (1) the list of parameters in Table 1 below;
 - (2) the additional parameters listed in Table 2 below, when the information data source for the parameter is used by helicopter systems or is available on the instrument panel for use by the flight crew to operate the helicopter; and
 - (3) any dedicated parameters related to novel or unique design or operational characteristics of the helicopter as determined by the Agency.
- (c) The parameters to be recorded should meet the performance specifications (range, sampling intervals, accuracy limits and resolution in read-out) as defined in the relevant tables of EUROCAE Document 112A, or any later equivalent standard produced by EUROCAE.

Table 1: FDR — All helicopters

No*	Parameter
1	Time or relative time count
2	Pressure altitude
3	Indicated airspeed or calibrated airspeed
4	Heading
5	Normal acceleration
6	Pitch attitude
7	Roll attitude
8	Manual radio transmission keying CVR/FDR synchronisation reference
9	Power on each engine:
9a	Free power turbine speed (N_F)
9b	Engine torque
9c	Engine gas generator speed (N_G)
9d	Flight crew compartment power control position
9e	Other parameters to enable engine power to be determined
10	Rotor:
10a	Main rotor speed
10b	Rotor brake (if installed)
11	Primary flight controls — pilot input or control output position if it is possible to derive either the control input or the control movement (one from the other) for all modes of operation and flight regimes. Otherwise, pilot input and control output position:
11a	Collective pitch
11b	Longitudinal cyclic pitch
11c	Lateral cyclic pitch
11d	Tail rotor pedal
11e	Controllable stabilator (if applicable)
11f	Hydraulic selection
12	Hydraulics low pressure (each system should be recorded)
13	Outside air temperature

No*	Parameter
18	Yaw rate or yaw acceleration
20	Longitudinal acceleration (body axis)
21	Lateral acceleration
25	Marker beacon passage
26	Warnings — including master warning, gearbox low oil pressure and stability augmentation system failure, and other 'red' warnings where the warning condition cannot be determined from other parameters or from the cockpit voice recorder
27	Each navigation receiver frequency selection
37	Engine control modes

* The number in the left-hand column reflects the serial numbers depicted in EUROCAE Document 112A.

Table 2: FDR - Helicopters for which the data source for the parameter is either used by the helicopter systems or is available on the instrument panel for use by the flight crew to operate the helicopter

No*	Parameter
14	AFCS mode and engagement status (showing which systems are engaged and which primary modes are controlling the flight path)
15	Stability augmentation system engagement (each system should be recorded)
16	Main gear box oil pressure
17	Gear box oil temperature:
17a	Main gear box oil temperature
17b	Intermediate gear box oil temperature
17c	Tail rotor gear box oil temperature
19	Indicated sling load force (if signals are readily available)
22	Radio altitude
23	Vertical deviation — the approach aid in use should be recorded:
23a	ILS glide path
23b	MLS elevation
23c	GNSS approach path
24	Horizontal deviation — the approach aid in use should be recorded:
24a	ILS localiser

No*	Parameter
24b	MLS azimuth
24c	GNSS approach path
28	DME 1 & 2 distances
29	Navigation data:
29a	Drift angle
29b	Wind speed
29c	Wind direction
29d	Latitude
29e	Longitude
29f	Ground speed
30	Landing gear or gear selector position
31	Engine exhaust gas temperature (T_4)
32	Turbine inlet temperature (TIT)/interstage turbine temperature ITT)
33	Fuel contents
34	Altitude rate (vertical speed) — only necessary when available from cockpit instruments
35	Ice detection
36	Helicopter health and usage monitor system (HUMS):
36a	Engine data
36b	Chip detector
36c	Track timing
36d	Exceedance discrettes
36e	Broadband average engine vibration
38	Selected barometric setting — to be recorded for helicopters where the parameter is displayed electronically:
38a	Pilot
38b	Co-pilot
39	Selected altitude (all pilot selectable modes of operation) — to be recorded for the helicopters where the parameter is displayed electronically
40	Selected speed (all pilot selectable modes of operation) — to be recorded for the helicopters where the parameter is displayed electronically

No*	Parameter
41	Selected Mach (all pilot selectable modes of operation) — to be recorded for the helicopters where the parameter is displayed electronically
42	Selected vertical speed (all pilot selectable modes of operation) — to be recorded for the helicopters where the parameter is displayed electronically
43	Selected heading (all pilot selectable modes of operation) — to be recorded for the helicopters where the parameter is displayed electronically
44	Selected flight path (all pilot selectable modes of operation) — to be recorded for the helicopters where the parameter is displayed electronically
45	Selected decision height (all pilot selectable modes of operation) — to be recorded for the helicopters where the parameter is displayed electronically
46	EFIS display format (showing the display system status):
46a	Pilot
46b	First officer
47	Multi-function/engine/alerts display format (showing the display system status)
48	Event marker
49	Status of ground proximity warning system (GPWS)/terrain awareness warning system (TAWS)/ground collision avoidance system (GCAS):
49a	Selection of terrain display mode including pop-up display status — for helicopters type certified before 1 January 2023, to be recorded only if this does not require extensive modification
49b	Terrain alerts, both cautions and warnings, and advisories — for helicopters type certified before 1 January 2023, to be recorded only if this does not require extensive modification
49c	On/off switch position — for helicopters type certified before 1 January 2023, to be recorded only if this does not require extensive modification
50	Traffic alert and collision avoidance system (TCAS)/airborne collision avoidance system (ACAS):
50a	Combined control — for helicopters type certified before 1 January 2023, to be recorded only if this does not require extensive modification
50b	Vertical control — for helicopters type certified before 1 January 2023, to be recorded only if this does not require extensive modification
50c	Up advisory — for helicopters type certified before 1 January 2023, to be recorded only if this does not require extensive modification
50d	Down advisory — for helicopters type certified before 1 January 2023, to be recorded only if this does not require extensive modification
50e	Sensitivity level — for helicopters type certified before 1 January 2023, to be recorded only if this does not require extensive modification

No*	Parameter
51	Primary flight controls — pilot input forces:
51a	Collective pitch — for helicopters type certified before 1 January 2023, to be recorded only if this does not require extensive modification
51b	Longitudinal cyclic pitch — for helicopters type certified before 1 January 2023, to be recorded only if this does not require extensive modification
51c	Lateral cyclic pitch — for helicopters type certified before 1 January 2023, to be recorded only if this does not require extensive modification
51d	Tail rotor pedal — for helicopters type certified before 1 January 2023, to be recorded only if this does not require extensive modification
52	Computed centre of gravity — for helicopters type certified before 1 January 2023, to be recorded only if this does not require extensive modification
53	Helicopter computed weight — for helicopters type certified before 1 January 2023, to be recorded only if this does not require extensive modification

* The number in the left-hand column reflects the serial numbers depicted in EUROCAE Document 112A.

AMC2 CAT.IDE.H.190 Flight data recorder

LIST OF PARAMETERS TO BE RECORDED FOR HELICOPTERS HAVING AN MCTOM OF MORE THAN 3 175 KG AND FIRST ISSUED WITH AN INDIVIDUAL COFA ON OR AFTER 1 AUGUST 1999 AND BEFORE 1 JANUARY 2016 AND HELICOPTERS HAVING AN MCTOM OF MORE THAN 7 000 KG OR AN MOPSC OF MORE THAN 9 AND FIRST ISSUED WITH AN INDIVIDUAL COFA ON OR AFTER 1 JANUARY 1989 AND BEFORE 1 AUGUST 1999

- (a) The FDR should, with reference to a timescale, record:
- (1) for helicopters with an MCTOM between 3 175 kg and 7 000 kg the parameters listed in Table 1 below;
 - (2) for helicopters with an MCTOM of more than 7 000 kg the parameters listed in Table 2 below;
 - (3) for helicopters equipped with electronic display systems, the additional parameters listed in Table 3 below; and
 - (4) any dedicated parameters relating to novel or unique design or operational characteristics of the helicopter.
- (b) When determined by the Agency, the FDR of helicopters with an MCTOM of more than 7 000 kg does not need to record parameter 19 of Table 2 below, if any of the following conditions are met:
- (1) the sensor is not readily available; or
 - (2) a change is required in the equipment that generates the data.
- (c) Individual parameters that can be derived by calculation from the other recorded parameters need not to be recorded, if agreed by the competent authority.

- (d) The parameters should meet, as far as practicable, the performance specifications (range, sampling intervals, accuracy limits and resolution in read-out) defined in AMC3 CAT.IDE.H.190.
- (e) If recording capacity is available, as many of the additional parameters as possible specified in table II-A.2 of EUROCAE Document ED 112 dated March 2003 should be recorded.
- (f) For the purpose of this AMC, a sensor is considered ‘readily available’ when it is already available or can be easily incorporated.

Table 1

Helicopters with an MCTOM of 7 000 kg or less

No	Parameter
1	Time or relative time count
2	Pressure altitude
3	Indicated airspeed or calibrated airspeed
4	Heading
5	Normal acceleration
6	Pitch attitude
7	Roll attitude
8	Manual radio transmission keying
9	Power on each engine (free power turbine speed and engine torque)/cockpit power control position (if applicable)
10a	Main rotor speed
10b	Rotor brake (if installed)
11	Primary flight controls — pilot input and control output position (if applicable)
11a	Collective pitch
11b	Longitudinal cyclic pitch
11c	Lateral cyclic pitch
11d	Tail rotor pedal
11e	Controllable stabiliser
11f	Hydraulic selection
13	Outside air temperature
14	Autopilot engagement status
15	Stability augmentation system engagement

26	Warnings
----	----------

Table 2

Helicopters with an MCTOM of more than 7 000 kg

No	Parameter
1	Time or relative time count
2	Pressure altitude
3	Indicated airspeed or calibrated airspeed
4	Heading
5	Normal acceleration
6	Pitch attitude
7	Roll attitude
8	Manual radio transmission keying
9	Power on each engine (free power turbine speed and engine torque)/cockpit power control position (if applicable)
10a	Main rotor speed
10b	Rotor brake (if installed)
11	Primary flight controls — pilot input and control output position (if applicable)
11a	Collective pitch
11b	Longitudinal cyclic pitch
11c	Lateral cyclic pitch
11d	Tail rotor pedal
11e	Controllable stabiliser
11f	Hydraulic selection
12	Hydraulics low pressure
13	Outside air temperature
14	AFCS mode and engagement status
15	Stability augmentation system engagement
16	Main gear box oil pressure

No	Parameter
17	Main gear box oil temperature
18	Yaw rate or yaw acceleration
19	Indicated sling load force (if installed)
20	Longitudinal acceleration (body axis)
21	Lateral acceleration
22	Radio altitude
23	Vertical beam deviation (ILS glide path or MLS elevation)
24	Horizontal beam deviation (ILS localiser or MLS azimuth)
25	Marker beacon passage
26	Warnings
27	Reserved (navigation receiver frequency selection is recommended)
28	Reserved (DME distance is recommended)
29	Reserved (navigation data are recommended)
30	Landing gear or gear selector position

Table 3

Helicopters equipped with electronic display systems

No	Parameter
38	Selected barometric setting (each pilot station)
39	Selected altitude
40	Selected speed
41	Selected Mach
42	Selected vertical speed
43	Selected heading
44	Selected flight path
45	Selected decision height

46	EFIS display format
47	Multi-function/engine/alerts display format

AMC3 CAT.IDE.H.190 Flight data recorder

PERFORMANCE SPECIFICATIONS FOR THE PARAMETERS TO BE RECORDED FOR HELICOPTERS HAVING AN MCTOM OF MORE THAN 3 175 KG AND FIRST ISSUED WITH AN INDIVIDUAL COFA ON OR AFTER 1 AUGUST 1999 AND BEFORE 1 JANUARY 2016 AND HELICOPTERS HAVING AN MCTOM OF MORE THAN 7 000 KG OR AN MOPSC OF MORE THAN 9 AND FIRST ISSUED WITH AN INDIVIDUAL COFA ON OR AFTER 1 JANUARY 1989 AND BEFORE 1 AUGUST 1999

Table 1

Helicopters with an MCTOM of 7 000 kg or less

No	Parameter	Range	Sampling interval in seconds	Accuracy Limits (sensor input compared to FDR read out)	Minimum Resolution in read out	Remarks
1	Time or relative time count					
1a or	Time	24 hours	4	± 0.125 % per hour	1 second	(a) UTC time preferred where available.
1b	Relative Time Count	0 to 4 095	4	± 0.125 % per hour		(b) Counter increments every 4 seconds of system operation.
2	Pressure altitude	-1 000 ft to 20 000 ft	1	±100 ft to ±700 ft Refer to table II.A-2 of EUROCAE Document ED-112	25 ft	
3	Indicated airspeed or calibrated airspeed	As the installed measuring system	1	± 5 % or ± 10 kt, whichever is greater	1 kt	
4	Heading	360 °	1	± 5°	1°	
5	Normal acceleration	- 3 g to + 6 g	0.125	± 0.2 g in addition to a maximum offset of ± 0.3 g	0.01 g	The resolution may be rounded from 0.01 g to 0.05 g, provided that one sample is recorded at full resolution at least every 4 seconds.

No	Parameter	Range	Sampling interval in seconds	Accuracy Limits (sensor input compared to FDR read out)	Minimum Resolution in read out	Remarks
6	Pitch attitude	100 % of usable range	0.5	± 2 degrees	0.8 degree	
7	Roll attitude	± 60 ° or 100 % of usable range from installed system if greater	0.5	± 2 degrees	0.8 degree	.
8	Manual radio transmission keying	Discrete(s)	1	-	-	Preferably each crew member but one discrete acceptable for all transmissions.
9	Power on each engine	Full range	Each engine each second	± 5 %	1 % of full range	Sufficient parameters, e.g. Power Turbine Speed and Engine Torque should be recorded to enable engine power to be determined. A margin for possible overspeed should be provided. Data may be obtained from cockpit indicators used for aircraft certification. Parameter 9c is required for helicopters with non-mechanically linked cockpit-engine controls
9a	Power turbine speed	Maximum range				
9b	Engine torque	Maximum range				
9c	Cockpit power control position	Full range or each discrete position	Each control each second	±2 % or sufficient to determine any gated position	2 % of full range	

No	Parameter	Range	Sampling interval in seconds	Accuracy Limits (sensor input compared to FDR read out)	Minimum Resolution in read out	Remarks
10	Rotor					
10a	Main rotor speed	Maximum range	1	± 5 %	1 % of full range	
10b	Rotor brake	Discrete	1	-		Where available
11	Primary flight controls - Pilot input and/or* control output position					<p>* For helicopters that can demonstrate the capability of deriving either the control input or control movement (one from the other) for all modes of operation and flight regimes, the 'or' applies. For helicopters with non-mechanical control systems the 'and' applies.</p> <p>Where the input controls for each pilot can be operated independently, both inputs will need to be recorded.</p>
11a	Collective pitch	Full range	0.5	± 3 %	1 % of full range	
11b	Longitudinal cyclic pitch		0.5			
11c	Lateral cyclic pitch		0.5			
11d	Tail rotor pedal		0.5			
11e	Controllable stabiliser		0.5			
11f	Hydraulic selection	Discretes	1	-	-	
12	Outside air temperature	Available range from installed system	2	± 2 °C	0.3°C	
13	Autopilot engagement	Discrete(s)	1			Where practicable, discretes should show which primary

No	Parameter	Range	Sampling interval in seconds	Accuracy Limits (sensor input compared to FDR read out)	Minimum Resolution in read out	Remarks
	status					modes are controlling the flight path of the helicopter
14	Stability augmentation system engagement	Discrete(s)	1			
15	Warnings	Discrete(s)	1	-	-	<p>A discrete should be recorded for the master warning, low hydraulic pressure (each system) gearbox low oil pressure and SAS fault status.</p> <p>Other 'red' warnings should be recorded where the warning condition cannot be determined from other parameters or from the cockpit voice recorder.</p>

Table 2

Helicopters with an MCTOM of more than 7 000 kg

N°	Parameter	Range	Sampling interval in seconds	Accuracy Limits (sensor input compared to FDR read out)	Minimum Resolution in read out	Remarks
1	Time or relative time count					
1a or	Time	24 hours	4	± 0.125 % per hour	1 second	(a) UTC time preferred where available.
1b	Relative time count	0 to 4095	4	± 0.125 % per hour		(b) Counter increments every 4 seconds of system operation.
2	Pressure altitude	-1 000 ft to maximum certificated altitude of aircraft +5 000 ft	1	± 100 ft to ± 700 ft Refer to table II-A.3 EUROCAE Document ED-112	5 ft	Should be obtained from the air data computer when installed.
3	Indicated airspeed or calibrated airspeed	As the installed measuring system	1	± 3 %	1 kt	Should be obtained from the air data computer when installed.
4	Heading	360 degrees	1	± 2 degrees	0.5 degree	
5	Normal acceleration	-3 g to +6 g	0.125	1 % of range excluding a datum error of 5 %	0.004 g	The recording resolution may be rounded from 0.004 g to 0.01 g provided that one sample is recorded at full resolution at least

N°	Parameter	Range	Sampling interval in seconds	Accuracy Limits (sensor input compared to FDR read out)	Minimum Resolution in read out	Remarks
						every 4 seconds.
6	Pitch attitude	± 75 degrees	0.5	± 2 degrees	0.5 degree	
7	Roll attitude	± 180 degrees	0.5	± 2 degrees	0.5 degree	.
8	Manual radio transmission Keying and CVR/FDR synchronisation reference	Discrete(s)	1	-	-	Preferably each crew member but one discrete acceptable for all transmissions provided that the replay of a recording made by any required recorder can be synchronised in time with any other required recording to within 1 second.
9	Power on each engine	Full range	Each engine each second	± 2 %	0.2 % of full range	Sufficient parameters e.g. Power Turbine Speed and engine torque should be recorded to enable engine power to be determined. A margin for possible overspeed should be provided.
9a	Free power turbine speed (N _F)	0-130 %				
9b	Engine torque	Full range				
9c	Cockpit power control position	Full range or each discrete position	Each control each second	± 2 % or sufficient to determine any gated position	2 % of full range	Parameter 9c is required for helicopters with non-mechanically linked cockpit-engine controls
10	Rotor				0.3 % of full range	
10a	Main rotor speed	50 to 130 %	0.5	2 %		.

N°	Parameter	Range	Sampling interval in seconds	Accuracy Limits (sensor input compared to FDR read out)	Minimum Resolution in read out	Remarks
10b	Rotor brake	Discrete	1			Where available
11	Primary flight controls - Pilot input and/or* control output position					* For helicopters that can demonstrate the capability of deriving either the control input or control movement (one from the other) for all modes of operation and flight regimes, the 'or' applies. For helicopters with non-mechanical control systems, the 'and' applies. Where the input controls for each pilot can be operated independently, both inputs will need to be recorded.
11a	Collective pitch	Full range	0.5	± 3 % unless higher accuracy is uniquely required	0.5 % of operating range	
11b	Longitudinal cyclic pitch		0.5			
11c	Lateral cyclic pitch		0.5			
11d	Tail rotor pedal		0.5			
11e	Controllable stabiliser		0.5			
11f	Hydraulic selection	Discrete(s)	1	-	-	
12	Hydraulics low pressure	Discrete(s)	1	-	-	Each essential system should be recorded.
13	Outside air temperature	-50° to +90°C or available sensor range	2	± 2°C	0.3°C	
14	AFCS mode and engagement status	A suitable combination of discrettes	1	-	-	Discrettes should show which systems are engaged and which primary modes are controlling the

N°	Parameter	Range	Sampling interval in seconds	Accuracy Limits (sensor input compared to FDR read out)	Minimum Resolution in read out	Remarks
						flight path of the helicopter.
15	Stability augmentation system engagement	Discrete	1	-	-	
16	Main gearbox oil pressure	As installed	1	As installed	6.895 kN/m ² (1 psi)	
17	Main gearbox oil temperature	As installed	2	As installed	1°C	
18	Yaw rate	± 400 degrees/second	0.25	± 1 %	2 degrees per second	An equivalent yaw acceleration is an acceptable alternative.
19	Indicated sling load force	0 to 200 % of maximum certified load	0.5	± 3 % of maximum certified load	0.5 % for maximum certified load	With reasonable practicability if sling load indicator is installed.
20	Longitudinal acceleration (body axis)	± 1 g	0.25	±1.5 % of range excluding a datum error of ±5 %	0.004 g	See comment to parameter 5.
21	Lateral acceleration	± 1 g	0.25	±1.5 % of range excluding a datum error of ±5 %	0.004 g	See comment to parameter 5.
22	Radio altitude	-20 ft to +2 500 ft	1	As installed. ± 2 ft or ± 3 % whichever is greater below 500 ft and ± 5 % above 500 ft recommended	1 ft below 500 ft, 1 ft + 0.5 % of full range	

N°	Parameter	Range	Sampling interval in seconds	Accuracy Limits (sensor input compared to FDR read out)	Minimum Resolution in read out	Remarks
					above 500 ft	
23	Vertical beam deviation		1	As installed ± 3 % recommended	0.3 % of full range	Data from both the ILS and MLS systems need not to be recorded at the same time. The approach aid in use should be recorded.
23a	ILS glide path	± 0.22 DDM or available sensor range as installed				
23b	MLS elevation	+0.9 to +30 degrees				
24	Horizontal beam deviation		1	As installed. ± 3 % recommended	0.3 % of full range	See comment to parameter 23
24a	ILS localiser	± 0.22 DDM or available sensor range as installed				
24b	MLS azimuth	± 62 degrees				
25	Marker beacon passage	Discrete	1	-	-	One discrete is acceptable for all markers.
26	Warnings	Discretets	1	-	-	A discrete should be recorded for the master warning, gearbox low oil pressure and SAS failure. Other 'red'

N°	Parameter	Range	Sampling interval in seconds	Accuracy Limits (sensor input compared to FDR read out)	Minimum Resolution in read out	Remarks
						warnings should be recorded where the warning condition cannot be determined from other parameters or from the cockpit voice recorder.
27	Reserved					
28	Reserved					
29	Reserved					
30	Landing gear or gear selector position	Discrete(s)	4	-	-	Where installed.

Table 3

Helicopters equipped with electronic display systems

N°	Parameter	Range	Sampling interval in seconds	Accuracy Limits (sensor input compared to FDR read out)	Minimum Resolution in read out	Remarks
38	Selected barometric setting (each pilot station)	As installed	64	As installed	1 mb	Where practicable, a sampling interval of 4 seconds is recommended.
38a	Pilot					
38b	Co-pilot					
39	Selected altitude	As installed	1	As installed	100 ft	Where capacity is limited, a sampling interval of 64 seconds is permissible.
39a	Manual					
39b	Automatic					
40	Selected speed	As installed	1	As installed	1 kt	Where capacity is limited, a sampling interval of 64 seconds is permissible.
40a	Manual					
40b	Automatic					
41	Selected Mach	As installed	1	As installed	0.01	Where capacity is limited, a sampling interval of 64 seconds is

N°	Parameter	Range	Sampling interval in seconds	Accuracy Limits (sensor input compared to FDR read out)	Minimum Resolution in read out	Remarks
						permissible.
41a	Manual					
41b	Automatic					
42	Selected vertical speed	As installed	1	As installed	100 ft/min	Where capacity is limited, a sampling interval of 64 seconds is permissible.
42a	Manual					
42b	Automatic					
43	Selected heading	360 degrees	1	As installed	100 ft /min	Where capacity is limited, a sampling interval of 64 seconds is permissible.
44	Selected flight path		1	As installed		
44a	Course/DSTRK				1 degree	
44b	Path angle				0.1 degree	
45	Selected decision height	0-500 ft	64	As installed	1ft	

N°	Parameter	Range	Sampling interval in seconds	Accuracy Limits (sensor input compared to FDR read out)	Minimum Resolution in read out	Remarks
46	EFIS display format	Discrete(s)	4	-	-	Discretes should show the display system status e.g. normal, fail, composite, sector, plan, rose, nav aids, wxr, range, copy
46a	Pilot					
46b	Co-pilot					
47	Multi-function/engine/alerts display format	Discrete(s)	4	-	-	Discretes should show the display system status, e.g. normal, fail, and the identity of the display pages for the emergency procedures and checklists. Information in checklists and procedures need not be recorded.

The term ‘where practicable’ used in the remarks column of Table 3 means that account should be taken of the following:

- (a) if the sensor is already available or can be easily incorporated;
- (b) sufficient capacity is available in the flight recorder system;
- (c) for navigational data (nav frequency selection, DME distance, latitude, longitude, groundspeed and drift) the signals are available in digital form;
- (d) the extent of modification required;
- (e) the down-time period; and
- (f) equipment software development.

GM1 CAT.IDE.H.190 Flight data recorder

GENERAL

For the purpose of AMC2 CAT.IDE.H.190(b), a sensor is considered ‘readily available’ when it is already available or can be easily incorporated.

CAT.IDE.H.195 Data link recording

- (a) Helicopters first issued with an individual CofA on or after 8 April 2014 that have the capability to operate data link communications and are required to be equipped with a CVR, shall record on a recorder, where applicable:
- (1) data link communication messages related to ATS communications to and from the helicopter, including messages applying to the following applications:
 - (i) data link initiation;
 - (ii) controller-pilot communication;
 - (iii) addressed surveillance;
 - (iv) flight information;
 - (v) as far as is practicable, given the architecture of the system, aircraft broadcast surveillance;
 - (vi) as far as is practicable, given the architecture of the system, aircraft operational control data;
 - (vii) as far as is practicable, given the architecture of the system, graphics;
 - (2) information that enables correlation to any associated records related to data link communications and stored separately from the helicopter; and
 - (3) information on the time and priority of data link communications messages, taking into account the system's architecture.
- (b) The recorder shall use a digital method of recording and storing data and information and a method of readily retrieving that data shall be available. The recording method shall allow the data to match the data recorded on the ground.
- (c) The recorder shall be capable of retaining data recorded for at least the same duration as set out for CVRs in CAT.IDE.H.185.
- (d) If the recorder is not deployable, it shall have a device to assist in locating it under water. By 1 January 2020 at the latest, this device shall have a minimum underwater transmission time of 90 days. If the recorder is deployable, it shall have an automatic emergency locator transmitter.
- (e) The requirements applicable to the start and stop logic of the recorder are the same as the requirements applicable to the start and stop logic of the CVR contained in CAT.IDE.H.185(d) and (e).

AMC1 CAT.IDE.H.195 Data link recording

GENERAL

- (a) The helicopter should be capable of recording the messages as specified in this AMC.
- (b) As a means of compliance with CAT.IDE.H.195(a), the recorder on which the data link messages are recorded may be:
- (1) the CVR;
 - (2) the FDR;
 - (3) a combination recorder when CAT.IDE.H.200 is applicable; or

- (4) a dedicated flight recorder. In that case, the operational performance requirements for this recorder should be those laid down in EUROCAE Document ED-112 (Minimum Operational Performance Specification for Crash Protected Airborne Recorder Systems) dated March 2003, including amendments No 1 and No 2, or any later equivalent standard produced by EUROCAE.
- (c) As a means of compliance with CAT.IDE.H.195(a)(2), the operator should enable correlation by providing information that allows an accident investigator to understand what data were provided to the helicopter and, when the provider identification is contained in the message, by which provider.
- (d) The timing information associated with the data link communications messages required to be recorded by CAT.IDE.H.195(a)(3) should be capable of being determined from the airborne-based recordings. This timing information should include at least the following:
- (1) the time each message was generated;
 - (2) the time any message was available to be displayed by the crew;
 - (3) the time each message was actually displayed or recalled from a queue; and
 - (4) the time of each status change.
- (e) The message priority should be recorded when it is defined by the protocol of the data link communication message being recorded.
- (f) The expression ‘taking into account the system architecture’, in CAT.IDE.H.195(a)(3), means that the recording of the specified information may be omitted if the existing source systems involved would require a major upgrade. The following should be considered:
- (1) the extent of the modification required;
 - (2) the down-time period; and
 - (3) equipment software development.
- (g) The intention is that new designs of source systems should include this functionality and support the full recording of the required information.
- (h) Data link communications messages that support the applications in Table 1 below should be recorded.
- (i) Further details on the recording requirements can be found in the recording requirement matrix in Appendix D.2 of EUROCAE Document ED-93 (Minimum Aviation System Performance Specification for CNS/ATM Recorder Systems, dated November 1998).

Table 1

Applications

Item No	Application Type	Application Description	Required Recording Content
1	Data link initiation	This includes any application used to log on to, or initiate, a data link service. In future air navigation system (FANS)-1/A and air traffic navigation (ATN), these are ATS facilities notification (AFN) and context management (CM), respectively.	C
2	Controller/pilot	This includes any application used to exchange requests,	C

	communication	clearances, instructions and reports between the flight crew and air traffic controllers. In FANS-1/A and ATN, this includes the controller pilot data link communications (CPDLC) application. CPDLC includes the exchange of oceanic clearances (OCLs) and departure clearances (DCLs).	
3	Addressed surveillance	This includes any surveillance application in which the ground sets up contracts for delivery of surveillance data. In FANS-1/A and ATN, this includes the automatic dependent surveillance-contract (ADS-C) application.	C, F2
4	Flight information	This includes any application used for delivery of flight information data to specific aeroplanes. This includes for example, data link-automatic terminal information service (D-ATIS), data link-operational terminal information service (D-OTIS), digital weather information services (D-METAR or TWIP), data link flight information service (D-FIS) and Notice to Airmen (D-NOTAM) delivery.	C
5	Aircraft broadcast surveillance	This includes elementary and enhanced surveillance systems, as well as automatic dependent surveillance-broadcast (ADS-B) output data.	M*, F2
6	Airlines operations centre (AOC) data	This includes any application transmitting or receiving data used for AOC purposes (in accordance with the ICAO definition of AOC). Such systems may also process AAC messages, but there is no requirement to record AAC messages	M*
7	Graphics	This includes any application receiving graphical data to be used for operational purposes (i.e. excluding applications that are receiving such things as updates to manuals).	M* F1

GM1 CAT.IDE.H.195 Data link recording

DEFINITIONS AND ACRONYMS

(a) The letters and expressions in Table 1 of AMC1 CAT.IDE.H.195 have the following meaning:

C: Complete contents recorded

M: Information that enables correlation with any associated records stored separately from the helicopter.

*: Applications that are to be recorded only as far as is practicable, given the architecture of the system.

F1: Graphics applications may be considered as AOC data when they are part of a data link communications application service run on an individual basis by the operator itself in the framework of the operational control.

F2: Where parametric data sent by the helicopter, such as Mode S, is reported within the message, it should be recorded unless data from the same source is recorded on the FDR.

- (b) The definitions of the applications type in Table 1 of AMC1 CAT.IDE.H.195 are described in Table 1 below.

Table 1

Descriptions of the applications type

Item No	Application Type	Messages	Comments
1	CM		CM is an ATN service
2	AFN		AFN is a FANS 1/A service
3	CPDLC		All implemented up and downlink messages to be recorded
4	ADS-C	ADS-C reports	All contract requests and reports recorded
		Position reports	Only used within FANS 1/A. Only used in oceanic and remote areas.
5	ADS-B	Surveillance data	Information that enables correlation with any associated records stored separately from the helicopter.
6	D-FIS		D-FIS is an ATN service. All implemented up and downlink messages to be recorded
7	TWIP	TWIP messages	Terminal weather information for pilots
8	D-ATIS	ATIS messages	Refer to EUROCAE Document ED-89A dated December 2003. Data Link Application System Document (DLASD) for the 'ATIS' Data Link Service
9	OCL	OCL messages	Refer to EUROCAE Document ED-106A dated March 2004. Data Link Application System Document (DLASD) for 'Oceanic Clearance' Data Link Service
10	DCL	DCL messages	Refer to EUROCAE Document ED-85A dated December 2003. Data Link Application System Document (DLASD) for 'Departure Clearance' Data Link Service
11	Graphics	Weather maps & other graphics	Graphics exchanged in the framework of procedures within the operational control, as specified in Part-ORO. Information that enables correlation with any associated records stored separately from the aeroplane.
12	AOC	Aeronautical operational control messages	Messages exchanged in the framework of procedures within the operational control, as specified in Part-ORO. Information that enables correlation with any associated records stored separately from the helicopter. Definition in EUROCAE Document ED-112, dated March 2003.

Item No	Application Type	Messages	Comments
13	Surveillance	Downlinked aircraft parameters (DAP)	As defined in ICAO Annex 10 Volume IV (Surveillance systems and ACAS).

AAC	aeronautical administrative communications
ADS-B	automatic dependent surveillance — broadcast
ADS-C	automatic dependent surveillance — contract
AFN	aircraft flight notification
AOC	aeronautical operational control
ATIS	automatic terminal information service
ATSC	air traffic service communication
CAP	controller access parameters
CPDLC	controller pilot data link communications
CM	configuration/context management
D-ATIS	data link ATIS
D-FIS	data link flight information service
DCL	departure clearance
FANS	Future Air Navigation System
FLIPCY	flight plan consistency
OCL	oceanic clearance
SAP	system access parameters
TWIP	terminal weather information for pilots

GM1 CAT.IDE.H.195(a) Data link recording

APPLICABILITY OF THE DATA LINK RECORDING REQUIREMENT

- (a) If it is certain that the helicopter cannot use data link communication messages for ATS communications corresponding to any application designated by CAT.IDE.H.195(a)(1), then the data link recording requirement does not apply.
- (b) Examples where the helicopter cannot use data link communication messages for ATS communications include but are not limited to the cases where:
- (1) the helicopter data link communication capability is disabled permanently and in a way that it cannot be enabled again during the flight;
 - (2) data link communications are not used to support air traffic service (ATS) in the area of operation of the helicopter; and
 - (3) the helicopter data link communication equipment cannot communicate with the equipment used by ATS in the area of operation of the helicopter.

CAT.IDE.H.200 Flight data and cockpit voice combination recorder

Compliance with CVR and FDR requirements may be achieved by the carriage of one combination recorder.

AMC1 CAT.IDE.H.200 Flight data and cockpit voice combination recorder

GENERAL

- (a) A flight data and cockpit voice combination recorder is a flight recorder that records:
- (1) all voice communications and the aural environment required by CAT.IDE.H.185 regarding CVRs; and
 - (2) all parameters required by CAT.IDE.H.190 regarding FDRs, with the same specifications required by those paragraphs.
- (b) In addition, a flight data and cockpit voice combination recorder may record data link communication messages and related information required by CAT.IDE.H.195.

CAT.IDE.H.205 Seats, seat safety belts, restraint systems and child restraint devices

- (a) Helicopters shall be equipped with:
- (1) a seat or berth for each person on board who is aged 24 months or more;
 - (2) a seat belt on each passenger seat and restraining belts for each berth;
 - (3) for helicopters first issued with an individual CofA on or after 1 August 1999, a safety belt with upper torso restraint system for use on each passenger seat for each passenger aged 24 months or more;
 - (4) a child restraint device (CRD) for each person on board younger than 24 months;
 - (5) a seat belt with upper torso restraint system incorporating a device that will automatically restrain the occupant's torso in the event of rapid deceleration on each flight crew seat;
 - (6) a seat belt with upper torso restraint system on each seat for the minimum required cabin crew.
- (b) A seat belt with upper torso restraint system shall:
- (1) have a single point release; and
 - (2) on flight crew seats and on the seats for the minimum required cabin crew include two shoulder straps and a seat belt that may be used independently.

AMC1 CAT.IDE.H.205 Seats, seat safety belts, restraint systems and child restraint devices

CHILD RESTRAINT DEVICES (CRDS)

- (a) A CRD is considered to be acceptable if:
- (1) it is a 'supplementary loop belt' manufactured with the same techniques and the same materials of the approved safety belts; or
 - (2) it complies with (b).
- (b) Provided the CRD can be installed properly on the respective helicopter seat, the following CRDs are considered acceptable:
- (1) CRDs approved for use in aircraft by a competent authority on the basis of a technical standard and marked accordingly;
 - (2) CRDs approved for use in motor vehicles according to the UN standard ECE R 44, -03 or later series of amendments;
 - (3) CRDs approved for use in motor vehicles and aircraft according to Canadian CMVSS 213/213.1;
 - (4) CRDs approved for use in motor vehicles and aircraft according to US FMVSS No 213 and are manufactured to these standards on or after February 26, 1985. US approved CRDs manufactured after this date must bear the following labels in red letters:
 - (i) 'THIS CHILD RESTRAINT SYSTEM CONFORMS TO ALL APPLICABLE FEDERAL MOTOR VEHICLE SAFETY STANDARDS'; and
 - (ii) 'THIS RESTRAINT IS CERTIFIED FOR USE IN MOTOR VEHICLES AND AIRCRAFT';
 - (5) CRDs qualified for use in aircraft according to the German 'Qualification Procedure for Child Restraint Systems for Use in Aircraft' (TÜV Doc.: TÜV/958-01/2001); and

- (6) devices approved for use in cars, manufactured and tested to standards equivalent to those listed above. The device should be marked with an associated qualification sign, which shows the name of the qualification organisation and a specific identification number, related to the associated qualification project. The qualifying organisation should be a competent and independent organisation that is acceptable to the competent authority.
- (c) Location
- (1) Forward-facing CRDs may be installed on both forward-and rearward-facing passenger seats, but only when fitted in the same direction as the passenger seat on which they are positioned. Rearward-facing CRDs should only be installed on forward-facing passenger seats. A CRD should not be installed within the radius of action of an airbag unless it is obvious that the airbag is de-activated or it can be demonstrated that there is no negative impact from the airbag.
 - (2) An infant in a CRD should be located as near to a floor level exit as feasible.
 - (3) An infant in a CRD should not hinder evacuation for any passenger.
 - (4) An infant in a CRD should neither be located in the row (where rows are existing) leading to an emergency exit nor located in a row immediately forward or aft of an emergency exit. A window passenger seat is the preferred location. An aisle passenger seat or a cross aisle passenger seat that forms part of the evacuation route to exits is not recommended. Other locations may be acceptable provided the access of neighbour passengers to the nearest aisle is not obstructed by the CRD.
 - (5) In general, only one CRD per row segment is recommended. More than one CRD per row segment is allowed if the infants are from the same family or travelling group provided the infants are accompanied by a responsible adult sitting next to them.
 - (6) A row segment is the fraction of a row separated by two aisles or by one aisle and the helicopter fuselage.
- (d) Installation
- (1) CRDs should only be installed on a suitable helicopter seat with the type of connecting device they are approved or qualified for. For instance, CRDs to be connected by a three-point harness only (most rearward facing baby CRDs currently available) should not be attached to a helicopter seat with a lap belt only, a CRD designed to be attached to a vehicle seat by means of rigid bar lower anchorages (ISO-FIX or US equivalent) only, should only be used on helicopter seats that are equipped with such connecting devices and should not be attached by the helicopter seat lap belt. The method of connecting should be the one shown in the manufacturer's instructions provided with each CRD.
 - (2) All safety and installation instructions must be followed carefully by the responsible person accompanying the infant. Cabin crew should prohibit the use of any inadequately installed CRD or not qualified seat.
 - (3) If a forward-facing CRD with a rigid backrest is to be fastened by a lap belt, the restraint device should be fastened when the backrest of the passenger seat on which it rests is in a reclined position. Thereafter, the backrest is to be positioned upright. This procedure ensures better tightening of the CRD on the aircraft seat if the aircraft seat is reclinable.
 - (4) The buckle of the adult safety belt must be easily accessible for both opening and closing, and must be in line with the seat belt halves (not canted) after tightening.
 - (5) Forward facing restraint devices with an integral harness must not be installed such that the adult safety belt is secured over the infant.

(e) Operation

- (1) Each CRD should remain secured to a passenger seat during all phases of flight unless it is properly stowed when not in use.
- (2) Where a CRD is adjustable in recline, it must be in an upright position for all occasions when passenger restraint devices are required.

AMC2 CAT.IDE.H.205 Seats, seat safety belts, restraint systems and child restraint devices

UPPER TORSO RESTRAINT SYSTEM

An upper torso restraint system having two shoulder straps and additional straps is deemed to be compliant with the requirement for restraint systems with two shoulder straps.

SEAT BELT

A seat belt with a diagonal shoulder strap (three anchorage points) is deemed to be compliant with the requirement for a seat belt (two anchorage points).

AMC3 CAT.IDE.H.205 Seats, seat safety belts, restraint systems and child restraint devices

SEATS FOR MINIMUM REQUIRED CABIN CREW

- (a) Seats for the minimum required cabin crew members should be located near required floor level emergency exits, except if the emergency evacuation of passengers would be enhanced by seating the cabin crew members elsewhere. In this case, other locations are acceptable. This criterion should also apply if the number of required cabin crew members exceeds the number of floor level emergency exits.
- (b) Seats for cabin crew member(s) should be forward or rearward facing within 15° of the longitudinal axis of the helicopter.

CAT.IDE.H.210 Fasten seat belt and no smoking signs

Helicopters in which not all passenger seats are visible from the flight crew seat(s) shall be equipped with a means of indicating to all passengers and cabin crew when seat belts shall be fastened and when smoking is not allowed.

CAT.IDE.H.220 First-aid kits

- (a) Helicopters shall be equipped with at least one first-aid kit.
- (b) First-aid kits shall be:
 - (1) readily accessible for use;
 - (2) kept up to date.

AMC1 CAT.IDE.H.220 First-aid kits

CONTENT OF FIRST-AID KITS

- (a) First-aid kits should be equipped with appropriate and sufficient medications and instrumentation. However, these kits should be complemented by the operator according to the characteristics of the operation (scope of operation, flight duration, number and demographics of passengers, etc.).
- (b) The following should be included in the first-aid kit:
 - (1) Equipment
 - (i) bandages (assorted sizes);
 - (ii) burns dressings (unspecified);
 - (iii) wound dressings (large and small);
 - (iv) adhesive dressings (assorted sizes);
 - (v) adhesive tape;
 - (vi) adhesive wound closures;
 - (vii) safety pins;
 - (viii) safety scissors;
 - (ix) antiseptic wound cleaner;
 - (x) disposable resuscitation aid;
 - (xi) disposable gloves;
 - (xii) tweezers: splinter; and
 - (xiii) thermometers (non-mercury).
 - (2) Medications
 - (i) simple analgesic (may include liquid form);
 - (ii) antiemetic;
 - (iii) nasal decongestant;
 - (iv) gastrointestinal antacid, in the case of helicopters carrying more than 9 passengers;
 - (v) anti-diarrhoeal medication in the case of helicopters carrying more than 9 passengers; and

- (vi) antihistamine.
- (3) Other
- (i) a list of contents in at least two languages (English and one other). This should include information on the effects and side effects of medications carried;
 - (ii) first-aid handbook, current edition;
 - (iii) medical incident report form;
 - (iv) biohazard disposal bags.
- (4) An eye irrigator, whilst not required to be carried in the first-aid kit, should, where possible, be available for use on the ground.

AMC2 CAT.IDE.H.220 First-aid kits

MAINTENANCE OF FIRST-AID KITS

To be kept up to date, first-aid kits should be:

- (a) inspected periodically to confirm, to the extent possible, that contents are maintained in the condition necessary for their intended use;
- (b) replenished at regular intervals, in accordance with instructions contained on their labels, or as circumstances warrant; and
- (c) replenished after use-in-flight at the first opportunity where replacement items are available.

CAT.IDE.H.240 Supplemental oxygen — non-pressurised helicopters

Non-pressurised helicopters operated at pressure altitudes above 10 000 ft shall be equipped with supplemental oxygen equipment capable of storing and dispensing the oxygen supplies in accordance with the following tables.

*Table 1***Oxygen minimum requirements for complex non-pressurised helicopters**

Supply for	Duration and cabin pressure altitude
1. Occupants of flight crew compartment seats on flight crew compartment duty and crew members assisting flight crew in their duties	The entire flying time at pressure altitudes above 10 000 ft.
2. Required cabin crew members	The entire flying time at pressure altitudes above 13 000 ft and for any period exceeding 30 minutes at pressure altitudes above 10 000 ft but not exceeding 13 000 ft.
3. Additional crew members and 100 % of passengers ⁽¹⁾	The entire flying time at pressure altitudes above 13 000 ft.
4. 10 % of passengers ⁽¹⁾	The entire flying time after 30 minutes at pressure altitudes above 10 000 ft but not exceeding 13 000 ft.
⁽¹⁾ Passenger numbers in Table 1 refer to passengers actually carried on board including persons younger than 24 months.	

*Table 2***Oxygen minimum requirements for other-than-complex non-pressurised helicopters**

Supply for	Duration and cabin pressure altitude
1. Occupants of flight crew compartment seats on flight crew compartment duty, crew members assisting flight crew in their duties, and required cabin crew members	The entire flying time at pressure altitudes above 13 000 ft and for any period exceeding 30 minutes at pressure altitudes above 10 000 ft but not exceeding 13 000 ft.
2. Additional crew members and 100 % of passengers ⁽¹⁾	The entire flying time at pressure altitudes above 13 000 ft.
3. 10 % of passengers ⁽¹⁾	The entire flying time after 30 minutes at pressure altitudes above 10 000 ft but not exceeding 13 000 ft.
⁽¹⁾ Passenger numbers in Table 2 refer to passengers actually carried on board including persons younger than 24 months.	

AMC1 CAT.IDE.H.240 Supplemental oxygen — non-pressurised helicopters

DETERMINATION OF OXYGEN

The amount of supplemental oxygen for sustenance for a particular operation should be determined on the basis of flight altitudes and flight duration, consistent with the operating procedures, including emergency, procedures, established for each operation and the routes to be flown as specified in the operations manual.

CAT.IDE.H.250 Hand fire extinguishers

- (a) Helicopters shall be equipped with at least one hand fire extinguisher in the flight crew compartment.
- (b) At least one hand fire extinguisher shall be located in, or readily accessible for use in, each galley not located on the main passenger compartment.
- (c) At least one hand fire extinguisher shall be available for use in each cargo compartment that is accessible to crew members in flight.
- (d) The type and quantity of extinguishing agent for the required fire extinguishers shall be suitable for the type of fire likely to occur in the compartment where the extinguisher is intended to be used and to minimise the hazard of toxic gas concentration in compartments occupied by persons.
- (e) The helicopter shall be equipped with at least a number of hand fire extinguishers in accordance with Table 1, conveniently located to provide adequate availability for use in each passenger compartment.

*Table 1***Number of hand fire extinguishers**

MOPSC	Number of extinguishers
7-30	1
31-60	2
61-200	3

AMC1 CAT.IDE.H.250 Hand fire extinguishers**NUMBER, LOCATION AND TYPE**

- (a) The number and location of hand fire extinguishers should be such as to provide adequate availability for use, account being taken of the number and size of the passenger compartments, the need to minimise the hazard of toxic gas concentrations and the location of lavatories, galleys, etc. These considerations may result in a number of fire extinguishers greater than the minimum required.
- (b) There should be at least one hand fire extinguisher installed in the flight crew compartment and this should be suitable for fighting both flammable fluid and electrical equipment fires. Additional hand fire extinguishers may be required for the protection of other compartments accessible to the crew in flight. Dry chemical fire extinguishers should not be used in the flight crew compartment, or in any compartment not separated by a partition from the flight crew compartment, because of the adverse effect on vision during discharge and, if conductive, interference with electrical contacts by the chemical residues.
- (c) Where only one hand fire extinguisher is required in the passenger compartments, it should be located near the cabin crew member's station, where provided.
- (d) Where two or more hand fire extinguishers are required in the passenger compartments and their location is not otherwise dictated by consideration of (a), an extinguisher should be located near each end of the cabin with the remainder distributed throughout the cabin as evenly as is practicable.

- (e) Unless an extinguisher is clearly visible, its location should be indicated by a placard or sign. Appropriate symbols may also be used to supplement such a placard or sign.

CAT.IDE.H.260 Marking of break-in points

If areas of the helicopter's fuselage suitable for break-in by rescue crews in an emergency are marked, such areas shall be marked as shown in Figure 1.

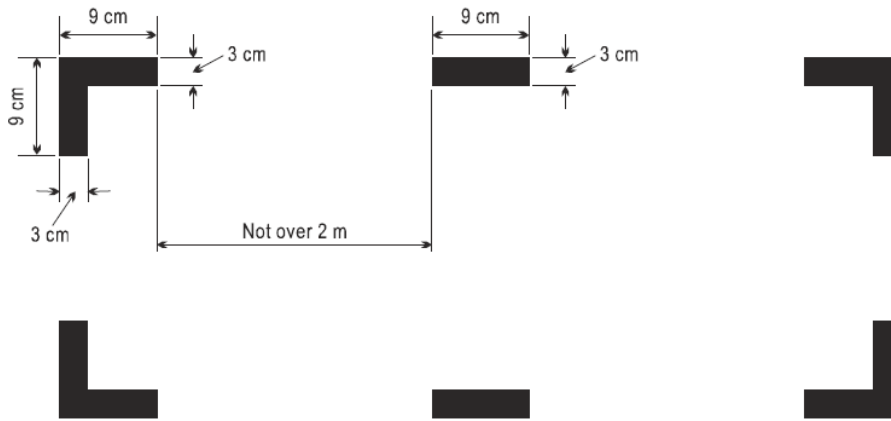
Figure 1**AMC1 CAT.IDE.H.260 Marking of break-in points****MARKINGS — COLOUR AND CORNERS**

- (a) The colour of the markings should be red or yellow and, if necessary, should be outlined in white to contrast with the background.
- (b) If the corner markings are more than 2 m apart, intermediate lines 9 cm x 3 cm should be inserted so that there is no more than 2 m between adjacent markings.

CAT.IDE.H.270 Megaphones

Helicopters with an MOPSC of more than 19 shall be equipped with one portable battery-powered megaphone readily accessible for use by crew members during an emergency evacuation.

AMC1 CAT.IDE.H.270 Megaphones

LOCATION OF MEGAPHONES

- (a) The megaphone should be readily accessible at the assigned seat of a cabin crew member or crew members other than flight crew.
- (b) This does not necessarily require megaphones to be positioned such that they can be physically reached by a crew member when strapped in a cabin crew member's seat.

CAT.IDE.H.275 Emergency lighting and marking

- (a) Helicopters with an MOPSC of more than 19 shall be equipped with:
 - (1) an emergency lighting system having an independent power supply to provide a source of general cabin illumination to facilitate the evacuation of the helicopter; and
 - (2) emergency exit marking and locating signs visible in daylight or in the dark.
- (b) Helicopters shall be equipped with emergency exit markings visible in daylight or in the dark when operated:
 - (1) in performance class 1 or 2 on a flight over water at a distance from land corresponding to more than 10 minutes flying time at normal cruising speed;
 - (2) in performance class 3 on a flight over water at a distance corresponding to more than three minutes flying time at normal cruising speed.

CAT.IDE.H.280 Emergency locator transmitter (ELT)

- (a) Helicopters shall be equipped with at least one automatic ELT.
- (b) Helicopters operating in performance class 1 or 2 used in offshore operations on a flight over water in a hostile environment and at a distance from land corresponding to more than 10 minutes flying time at normal cruising speed shall be equipped with an automatically deployable ELT (ELT(AD)).
- (c) An ELT of any type shall be capable of transmitting simultaneously on 121,5 MHz and 406 MHz.

AMC1 CAT.IDE.H.280 Emergency locator transmitter (ELT)**BATTERIES**

- (a) All batteries used in ELTs should be replaced (or recharged if the battery is rechargeable) when the equipment has been in use for more than 1 cumulative hour or in the following cases:
 - (1) Batteries specifically designed for use in ELTs and having an airworthiness release certificate (EASA Form 1 or equivalent) should be replaced (or recharged if the battery is rechargeable) before the end of their useful life in accordance with the maintenance instructions applicable to the ELT.
 - (2) Standard batteries manufactured in accordance with an industry standard and not having an airworthiness release certificate (EASA Form 1 or equivalent), when used in ELTs should be replaced (or recharged if the battery is rechargeable) when 50 % of their useful life (or for rechargeable, 50 % of their useful life of charge), as established by the battery manufacturer, has expired.
 - (3) The battery useful life (or useful life of charge) criteria in (1) and (2) do not apply to batteries (such as water-activated batteries) that are essentially unaffected during probable storage intervals.
- (b) The new expiry date for a replaced (or recharged) battery should be legibly marked on the outside of the equipment.

AMC2 CAT.IDE.H.280 Emergency locator transmitter (ELT)

TYPES OF ELT AND GENERAL TECHNICAL SPECIFICATIONS

- (a) The ELT required by this provision should be one of the following:
- (1) Automatic Fixed (ELT(AF)). An automatically activated ELT that is permanently attached to an aircraft and is designed to aid search and rescue (SAR) teams in locating the crash site.
 - (2) Automatic Portable (ELT(AP)). An automatically activated ELT, which is rigidly attached to an aircraft before a crash, but is readily removable from the aircraft after a crash. It functions as an ELT during the crash sequence. If the ELT does not employ an integral antenna, the aircraft-mounted antenna may be disconnected and an auxiliary antenna (stored in the ELT case) attached to the ELT. The ELT can be tethered to a survivor or a life-raft. This type of ELT is intended to aid SAR teams in locating the crash site or survivor(s).
 - (3) Automatic Deployable (ELT(AD)). An ELT that is rigidly attached to the aircraft before the crash and that is automatically ejected, deployed and activated by an impact, and, in some cases, also by hydrostatic sensors. Manual deployment is also provided. This type of ELT should float in water and is intended to aid SAR teams in locating the crash site.
 - (4) Survival ELT (ELT(S)). An ELT that is removable from an aircraft, stowed so as to facilitate its ready use in an emergency, and manually activated by a survivor. An ELT(S) may be activated manually or automatically (e.g. by water activation). It should be designed either to be tethered to a life-raft or a survivor.
- (b) To minimise the possibility of damage in the event of crash impact, the automatic ELT should be rigidly fixed to the aircraft structure, as far aft as is practicable, with its antenna and connections arranged so as to maximise the probability of the signal being transmitted after a crash.
- (c) Any ELT carried should operate in accordance with the relevant provisions of ICAO Annex 10, Volume III Communications Systems and should be registered with the national agency responsible for initiating search and rescue or other nominated agency.

GM1 CAT.IDE.H.280 Emergency locator transmitter (ELT)

TERMINOLOGY

‘ELT’ is a generic term describing equipment that broadcasts distinctive signals on designated frequencies and, depending on application, may be activated by impact or may be manually activated.

CAT.IDE.H.290 Life-jackets

- (a) Helicopters shall be equipped with a life-jacket for each person on board or equivalent flotation device for each person on board younger than 24 months, stowed in a position that is readily accessible from the seat or berth of the person for whose use it is provided, when operated in:
- (1) performance class 1 or 2 on a flight over water at a distance from land corresponding to more than 10 minutes flying time at normal cruising speed;
 - (2) performance class 3 on a flight over water beyond autorotational distance from land;
 - (3) performance class 2 or 3 when taking off or landing at an aerodrome or operating site where the take-off or approach path is over water.
- (b) Each life-jacket or equivalent individual flotation device shall be equipped with a means of electric illumination for the purpose of facilitating the location of persons.

AMC1 CAT.IDE.H.290 Life-jackets

ACCESSIBILITY

The life-jacket should be accessible from the seat or berth of the person for whose use it is provided, with a safety belt or harness fastened.

AMC2 CAT.IDE.H.290(b) Life-jackets

ELECTRIC ILLUMINATION

The means of electric illumination should be a survivor locator light as defined in the applicable ETSO issued by the Agency or equivalent.

GM1 CAT.IDE.H.290 Life-jackets

SEAT CUSHIONS

Seat cushions are not considered to be flotation devices.

CAT.IDE.H.295 Crew survival suits

Each crew member shall wear a survival suit when operating in performance class 3 on a flight over water beyond autorotational distance or safe forced landing distance from land, when the weather report or forecasts available to the commander indicate that the sea temperature will be less than plus 10 °C during the flight:

- (a) in performance class 1 or 2 on a flight over water in support of offshore operations, at a distance from land corresponding to more than 10 minutes flying time at normal cruising speed, when the weather report or forecasts available to the commander indicate that the sea temperature will be less than plus 10 °C during the flight, or when the estimated rescue time exceeds the estimated survival time;
- (b) in performance class 3 on a flight over water beyond autorotational distance or safe forced landing distance from land, when the weather report or forecasts available to the commander indicate that the sea temperature will be less than plus 10 °C during the flight.

Grey text shall be applicable until 01 July 2018, then deleted

GM1 CAT.IDE.H.295 Crew survival suits**ESTIMATING SURVIVAL TIME**

- (a) Introduction
 - (1) A person accidentally immersed in cold seas (typically offshore Northern Europe) will have a better chance of survival if he/she is wearing an effective survival suit in addition to a life-jacket. By wearing the survival suit, he/she can slow down the rate which his/her body temperature falls and, consequently, protect himself/herself from the greater risk of drowning brought about by incapacitation due to hypothermia.
 - (2) The complete survival suit system – suit, life-jacket and clothes worn under the suit – should be able to keep the wearer alive long enough for the rescue services to find and recover him/her. In practice the limit is about 3 hours. If a group of persons in the water cannot be rescued within this time they are likely to have become so scattered and separated that location will be extremely difficult, especially in the rough water typical of Northern European sea areas. If it is expected that in water protection could be required for periods greater than 3 hours, improvements should, rather, be sought in the search and rescue procedures than in the immersion suit protection.
- (b) Survival times
 - (1) The aim should be to ensure that a person in the water can survive long enough to be rescued, i.e. the survival time must be greater than the likely rescue time. The factors affecting both times are shown in Figure 1 below. The figure emphasises that survival time is influenced by many factors, physical and human. Some of the factors are relevant to survival in cold water and some are relevant to survival in water at any temperature.

Figure 1

The survival equation

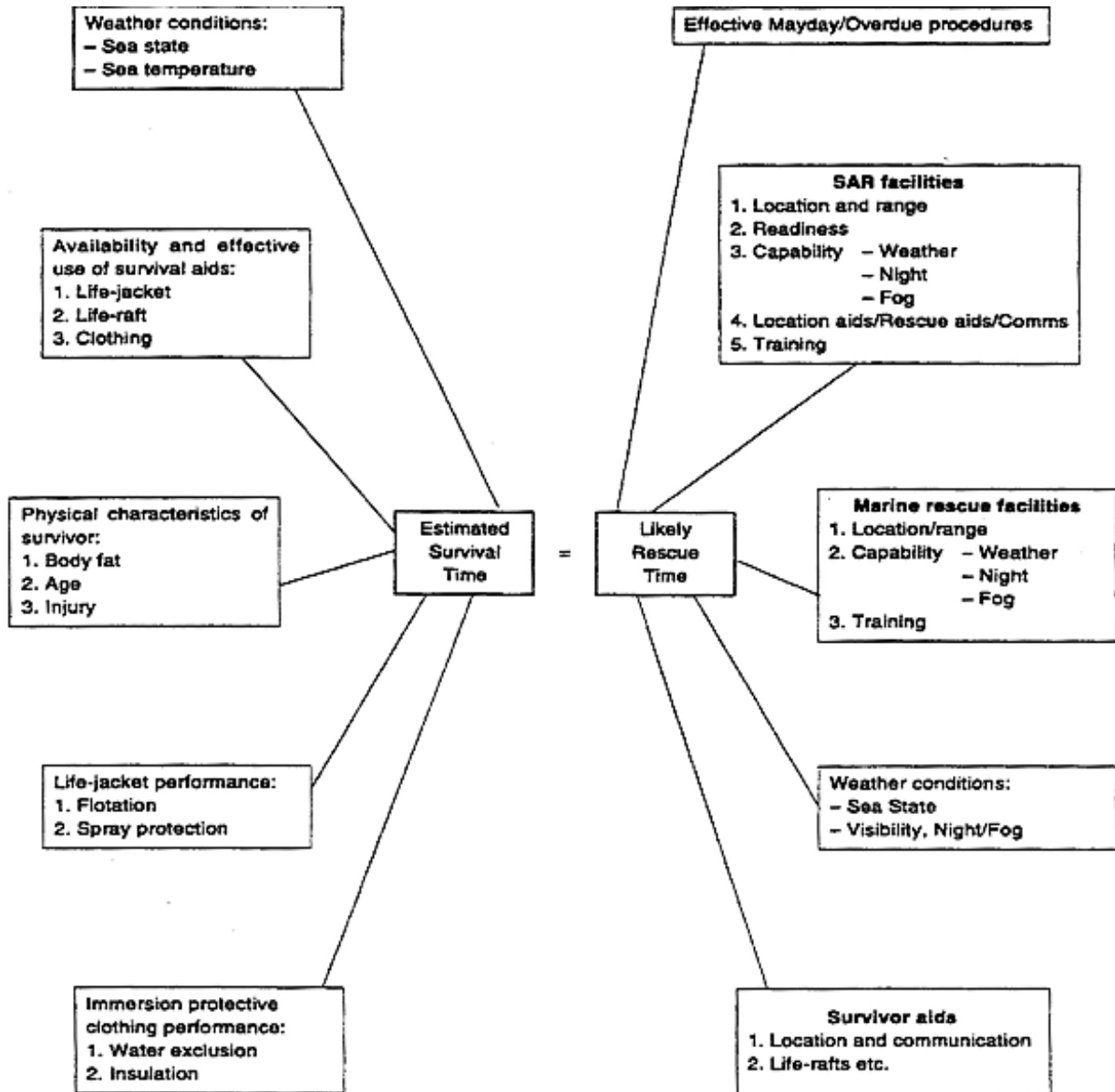

- (2) Broad estimates of likely survival times for the thin individual offshore are given in Table 1 below. As survival time is significantly affected by the prevailing weather conditions at the time of immersion, the Beaufort wind scale has been used as an indicator of these surface conditions.

Table 1

Timescale within which the most vulnerable individuals are likely to succumb to the prevailing conditions.

Clothing assembly	Beaufort wind force	Times within which the most vulnerable individuals are likely to drown	
		(water temp 5°C)	(water temp 13°C)
Working clothes	0 – 2	Within ¼ hour	Within 1 ¼ hours

Clothing assembly	Beaufort wind force	Times within which the most vulnerable individuals are likely to drown	
		(water temp 5°C)	(water temp 13°C)
(no immersion suit)	3 – 4	Within ½ hour	Within ½ hour
	5 and above	Significantly less than ½ hour	Significantly less than ½ hour
Immersion suit worn over working clothes (with leakage inside suit)	0 -2	May well exceed 3 hours	May well exceed 3 hours
	3 – 4	Within 2 ¾ hours	May well exceed 3 hours
	5 and above	Significantly less than 2 ¾ hours. May well exceed 1 hour	May well exceed 3 hours

- (3) Consideration should also be given to escaping from the helicopter itself should it submerge or invert in the water. In this case, escape time is limited to the length of time the occupants can hold their breath. The breath holding time can be greatly reduced by the effect of cold shock. Cold shock is caused by the sudden drop in skin temperature on immersion, and is characterised by a gasp reflex and uncontrolled breathing. The urge to breathe rapidly becomes overwhelming and, if still submerged, the individual will inhale water resulting in drowning. Delaying the onset of cold shock by wearing an immersion suit will extend the available escape time from a submerged helicopter.
- (4) The effects of water leakage and hydrostatic compression on the insulation quality of clothing are well recognised. In a nominally dry system, the insulation is provided by still air trapped within the clothing fibres and between the layers of suit and clothes. It has been observed that many systems lose some of their insulative capacity either because the clothes under the 'waterproof' survival suit get wet to some extent or because of hydrostatic compression of the whole assembly. As a result of water leakage and compression, survival times will be shortened. The wearing of warm clothing under the suit is recommended.
- (5) Whatever type of survival suit and other clothing is provided, it should not be forgotten that significant heat loss can occur from the head.

CAT.IDE.H.300 Life-rafts, survival ELTs and survival equipment on extended overwater flights

Helicopters operated:

- (a) in performance class 1 or 2 on a flight over water at a distance from land corresponding to more than 10 minutes flying time at normal cruising speed;
- (b) in performance class 3 on a flight over water at a distance corresponding to more than three minutes flying time at normal cruising speed, shall be equipped with:
 - (1) in the case of a helicopter carrying less than 12 persons, at least one life-raft with a rated capacity of not less than the maximum number of persons on board, stowed so as to facilitate its ready use in an emergency;
 - (2) in the case of a helicopter carrying more than 11 persons, at least two life-rafts, stowed so as to facilitate their ready use in an emergency, sufficient together to accommodate all persons capable of being carried on board and, if one is lost, the remaining life-raft(s) having, the overload capacity sufficient to accommodate all persons on the helicopter;
 - (3) at least one survival ELT (ELT(S)) for each required life-raft; and
 - (4) life-saving equipment, including means of sustaining life, as appropriate to the flight to be undertaken.

AMC1 CAT.IDE.H.300 Life-rafts, survival ELTs and survival equipment on extended overwater flights

LIFE-RAFTS AND EQUIPMENT FOR MAKING DISTRESS SIGNALS - HELICOPTERS

- (a) Each required life-raft should conform to the following specifications:
 - (1) be of an approved design and stowed so as to facilitate their ready use in an emergency;
 - (2) be radar conspicuous to standard airborne radar equipment;
 - (3) when carrying more than one life-raft on board, at least 50 % should be able to be deployed by the crew while seated at their normal station, where necessary by remote control; and
 - (4) life-rafts that are not deployable by remote control or by the crew should be of such weight as to permit handling by one person. 40 kg should be considered a maximum weight.
- (b) Each required life-raft should contain at least the following:
 - (1) one approved survivor locator light;
 - (2) one approved visual signalling device;
 - (3) one canopy (for use as a sail, sunshade or rain catcher) or other mean to protect occupants from the elements;
 - (4) one radar reflector;
 - (5) one 20-m retaining line designed to hold the life-raft near the helicopter but to release it if the helicopter becomes totally submerged;
 - (6) one sea anchor;
 - (7) one survival kit, appropriately equipped for the route to be flown, which should contain at least the following:
 - (i) one life-raft repair kit;
 - (ii) one bailing bucket;
 - (iii) one signalling mirror;

- (iv) one police whistle;
- (v) one buoyant raft knife;
- (vi) one supplementary means of inflation;
- (vii) sea sickness tablets;
- (viii) one first-aid kit;
- (ix) one portable means of illumination;
- (x) 500 ml of pure water and one sea water desalting kit; and
- (xi) one comprehensive illustrated survival booklet in an appropriate language.

AMC1 CAT.IDE.H.300(b)(3) & CAT.IDE.H.305(b) Flight over water & Survival equipment**SURVIVAL ELT**

An ELT(AP) may be used to replace one required ELT(S) provided that it meets the ELT(S) requirements. A water-activated ELT(S) is not an ELT(AP).

CAT.IDE.H.305 Survival equipment

Helicopters operated over areas in which search and rescue would be especially difficult shall be equipped with:

- (a) signalling equipment to make distress signals;
- (b) at least one ELT(S); and
- (c) additional survival equipment for the route to be flown taking account of the number of persons on board.

AMC1 CAT.IDE.H.305 Survival equipment

ADDITIONAL SURVIVAL EQUIPMENT

- (a) The following additional survival equipment should be carried when required:
 - (1) 500 ml of water for each 4, or fraction of 4, persons on board;
 - (2) one knife;
 - (3) first-aid equipment; and
 - (4) one set of air/ground codes.
- (b) In addition, when polar conditions are expected, the following should be carried:
 - (1) a means for melting snow;
 - (2) one snow shovel and 1 ice saw;
 - (3) sleeping bags for use by 1/3 of all persons on board and space blankets for the remainder or space blankets for all passengers on board; and
 - (4) one arctic/polar suit for each crew member.
- (c) If any item of equipment contained in the above list is already carried on board the helicopter in accordance with another requirement, there is no need for this to be duplicated.

AMC1 CAT.IDE.H.300(b)(3) & CAT.IDE.H.305(b) Flight over water & Survival equipment

See [here](#).

GM1 CAT.IDE.H.305 Survival equipment

SIGNALLING EQUIPMENT

The signalling equipment for making distress signals is described in ICAO Annex 2, Rules of the Air.

GM2 CAT.IDE.H.305 Survival equipment

AREAS IN WHICH SEARCH AND RESCUE WOULD BE ESPECIALLY DIFFICULT

The expression 'areas in which search and rescue would be especially difficult' should be interpreted, in this context, as meaning:

- (a) areas so designated by the authority responsible for managing search and rescue; or
- (b) areas that are largely uninhabited and where:

-
- (1) the authority referred to in (a) has not published any information to confirm whether search and rescue would be or would not be especially difficult; and
 - (2) the authority referred to in (a) does not, as a matter of policy, designate areas as being especially difficult for search and rescue.

Applicable until 01 July 2018, then deleted

CAT.IDE.H.310 Additional requirements for helicopters conducting offshore operations in a hostile sea area

Helicopters operated in offshore operations in a hostile sea area, at a distance from land corresponding to more than 10 minutes flying time at normal cruising speed, shall comply with the following:

- (a) When the weather report or forecasts available to the commander indicate that the sea temperature will be less than plus 10 °C during the flight, or when the estimated rescue time exceeds the calculated survival time, or the flight is planned to be conducted at night, all persons on board shall wear a survival suit.
- (b) All life-rafts carried in accordance with CAT.IDE.H.300 shall be installed so as to be usable in the sea conditions in which the helicopter's ditching, flotation and trim characteristics were evaluated in order to comply with the ditching requirements for certification.
- (c) The helicopter shall be equipped with an emergency lighting system with an independent power supply to provide a source of general cabin illumination to facilitate the evacuation of the helicopter.
- (d) All emergency exits, including crew emergency exits, and the means for opening them shall be conspicuously marked for the guidance of occupants using the exits in daylight or in the dark. Such markings shall be designed to remain visible if the helicopter is capsized and the cabin is submerged.
- (e) All non-jettisonable doors that are designated as ditching emergency exits shall have a means of securing them in the open position so that they do not interfere with occupants' egress in all sea conditions up to the maximum required to be evaluated for ditching and flotation.
- (f) All doors, windows or other openings in the passenger compartment assessed as suitable for the purpose of underwater escape shall be equipped so as to be operable in an emergency.
- (g) Life-jackets shall be worn at all times, unless the passenger or crew member is wearing an integrated survival suit that meets the combined requirement of the survival suit and life-jacket.

Applicable until 01 July 2018, then deleted

AMC1 CAT.IDE.H.310 Additional requirements for helicopters operating to or from helidecks located in a hostile sea area

INSTALLATION OF THE LIFE-RAFT

- (a) Projections on the exterior surface of the helicopter, that are located in a zone delineated by boundaries that are 1.22 m (4 ft) above and 0.61 m (2 ft) below the established static water line could cause damage to a deployed life-raft. Examples of projections that need to be considered are aerials, overboard vents, unprotected split-pin tails, guttering and any projection sharper than a three dimensional right angled corner.
- (b) While the boundaries specified in (a) are intended as a guide, the total area that should be considered should also take into account the likely behaviour of the life-raft after deployment in all sea states up to the maximum in which the helicopter is capable of remaining upright.
- (c) Wherever a modification or alteration is made to a helicopter within the boundaries specified, the need to prevent the modification or alteration from causing damage to a deployed life-raft should be taken into account in the design.
- (d) Particular care should also be taken during routine maintenance to ensure that additional hazards are not introduced by, for example, leaving inspection panels with sharp corners proud of the surrounding fuselage surface, or allowing door sills to deteriorate to a point where sharp edges become a hazard.

CAT.IDE.H.315 Helicopters certified for operating on water — miscellaneous equipment

Helicopters certified for operating on water shall be equipped with:

- (a) a sea anchor and other equipment necessary to facilitate mooring, anchoring or manoeuvring the helicopter on water, appropriate to its size, weight and handling characteristics; and
- (b) equipment for making the sound signals prescribed in the International Regulations for Preventing Collisions at Sea, where applicable.

GM1 CAT.IDE.H.315 Helicopters certificated for operating on water — Miscellaneous equipment**INTERNATIONAL REGULATIONS FOR PREVENTING COLLISIONS AT SEA**

International Regulations for Preventing Collisions at Sea are those that were published by the International Maritime Organisation (IMO) in 1972.

CAT.IDE.H.320 All helicopters on flights over water — ditching

- (a) Helicopters shall be designed for landing on water or certified for ditching in accordance with the relevant airworthiness code when operated in performance class 1 or 2 on a flight over water in a hostile environment at a distance from land corresponding to more than 10 minutes flying time at normal cruise speed.
- (b) Helicopters shall be designed for landing on water or certified for ditching in accordance the relevant airworthiness code or fitted with emergency flotation equipment when operated in:
- (1) performance class 1 or 2 on a flight over water in a non-hostile environment at a distance from land corresponding to more than 10 minutes flying time at normal cruise speed;
 - (2) performance class 2, when taking off or landing over water, except in the case of helicopter emergency medical services (HEMS) operations, where for the purpose of minimising exposure, the landing or take-off at a HEMS operating site located in a congested environment is conducted over water;
 - (3) performance class 3 on a flight over water beyond safe forced landing distance from land.

Applicable from 01 July 2018.

GM1 CAT.IDE.H.320 Landing on water**DESIGN FOR LANDING ON WATER**

A helicopter is designed for landing on water if safety provisions at least equivalent to those for ditching (CS 27.801/CS 29.801) are met.

AMC1 CAT.IDE.H.320(b) All helicopters on flight over water — ditching**GENERAL**

The same considerations of AMC1 CAT.IDE.H.310 should apply in respect of emergency flotation equipment.

Applicable until 01 July 2018, then replaced by the paragraph below.

The same considerations of AMC1 SPA.HOFO.165(d) should apply in respect of emergency flotation equipment.

Applicable from 01 July 2018. Will replace the paragraph above.

CAT.IDE.H.325 Headset

Whenever a radio communication and/or radio navigation system is required, helicopters shall be equipped with a headset with boom microphone or equivalent and a transmit button on the flight controls for each required pilot and/or crew member at his/her assigned station.

AMC1 CAT.IDE.H.325 Headset

GENERAL

- (a) A headset consists of a communication device that includes two earphones to receive and a microphone to transmit audio signals to the helicopter's communication system. To comply with the minimum performance requirements, the earphones and microphone should match the communication system's characteristics and the cockpit environment. The headset should be adequately adjustable in order to fit the pilot's head. Headset boom microphones should be of the noise cancelling type.
- (b) If the intention is to utilise noise cancelling earphones, the operator should ensure that the earphones do not attenuate any aural warnings or sounds necessary for alerting the flight crew on matters related to the safe operation of the helicopter.

GM1 CAT.IDE.H.325 Headset

GENERAL

The term 'headset' includes any aviation helmet incorporating headphones and microphone worn by a flight crew member.

CAT.IDE.H.330 Radio communication equipment

- (a) Helicopters shall be equipped with the radio communication equipment required by the applicable airspace requirements.
- (b) The radio communication equipment shall provide for communication on the aeronautical emergency frequency 121,5 MHz.

CAT.IDE.H.335 Audio selector panel

Helicopters operated under IFR shall be equipped with an audio selector panel operable from each required flight crew member station.

CAT.IDE.H.340 Radio equipment for operations under VFR over routes navigated by reference to visual landmarks

Helicopters operated under VFR over routes that can be navigated by reference to visual landmarks shall be equipped with radio communication equipment necessary under normal radio propagation conditions to fulfil the following:

- (a) communicate with appropriate ground stations;
- (b) communicate with appropriate ATC stations from any point in controlled airspace within which flights are intended; and
- (c) receive meteorological information.

CAT.IDE.H.345 Communication and navigation equipment for operations under IFR or under VFR over routes not navigated by reference to visual landmarks

- (a) Helicopters operated under IFR or under VFR over routes that cannot be navigated by reference to visual landmarks shall be equipped with radio communication and navigation equipment in accordance with the applicable airspace requirements.
- (b) Radio communication equipment shall include at least two independent radio communication systems necessary under normal operating conditions to communicate with an appropriate ground station from any point on the route, including diversions.
- (c) Helicopters shall have sufficient navigation equipment to ensure that, in the event of the failure of one item of equipment at any stage of the flight, the remaining equipment shall allow safe navigation in accordance with the flight plan.
- (d) Helicopters operated on flights in which it is intended to land in IMC shall be equipped with suitable equipment capable of providing guidance to a point from which a visual landing can be performed for each aerodrome at which it is intended to land in IMC and for any designated alternate aerodromes.
- (e) For PBN operations the aircraft shall meet the airworthiness certification requirements for the appropriate navigation specification.

AMC1 CAT.IDE.H.345 Communication and navigation equipment for operations under IFR or under VFR over routes not navigated by reference to visual landmarks

TWO INDEPENDENT MEANS OF COMMUNICATION

Whenever two independent means of communication are required, each system should have an independent antenna installation, except where rigidly supported non-wire antennae or other antenna installations of equivalent reliability are used.

AMC2 CAT.IDE.H.345 Communication and navigation equipment for operations under IFR or under VFR over routes not navigated by reference to visual landmarks

ACCEPTABLE NUMBER AND TYPE OF COMMUNICATION AND NAVIGATION EQUIPMENT

- (a) An acceptable number and type of communication and navigation equipment is:
- (1) two VHF omnidirectional radio range (VOR) receiving systems on any route, or part thereof, where navigation is based only on VOR signals;
 - (2) two automatic direction finder (ADF) systems on any route, or part thereof, where navigation is based only on non-directional beacon (NDB) signals; and
 - (3) area navigation equipment when area navigation is required for the route being flown (e.g. equipment required by Part-SPA).
- (b) The helicopter may be operated without the navigation equipment specified in (a)(1) and (a)(2) provided it is equipped with alternative equipment. The reliability and the accuracy of alternative equipment should allow safe navigation for the intended route.
- (c) VHF communication equipment, instrument landing system (ILS) localiser and VOR receivers installed on helicopters to be operated under IFR should comply with the following FM immunity performance standards:
- (1) ICAO Annex 10, Volume I – Radio Navigation Aids, and Volume III, Part II – Voice Communications Systems; and
 - (2) acceptable equipment standards contained in EUROCAE Minimum Operational Performance Specifications, documents ED-22B for VOR receivers, ED-23B for VHF communication receivers and ED-46B for LOC receivers and the corresponding Radio Technical Commission for Aeronautics (RTCA) documents DO-186, DO-195 and DO-196.

AMC3 CAT.IDE.H.345 Communication and navigation equipment for operations under IFR or under VFR over routes not navigated by reference to visual landmarks

FAILURE OF A SINGLE UNIT

Required communication and navigation equipment should be installed such that the failure of any single unit required for either communication or navigation purposes, or both, will not result in the failure of another unit required for communications or navigation purposes.

GM1 CAT.IDE.H.345 Communication and navigation equipment for operations under IFR or under VFR over routes not navigated by reference to visual landmarks

APPLICABLE AIRSPACE REQUIREMENTS

For helicopters being operated under European air traffic control, the applicable airspace requirements include the Single European Sky legislation.

GM2 CAT.IDE.H.345 Communication and navigation equipment for operations under IFR or under VFR over routes not navigated by reference to visual landmarks

AIRCRAFT ELIGIBILITY FOR PBN SPECIFICATION NOT REQUIRING SPECIFIC APPROVAL

- (a) The performance of the aircraft is usually stated in the AFM.
- (b) Where such a reference cannot be found in the AFM, other information provided by the aircraft manufacturer as TC holder, the STC holder or the design organisation having a privilege to approve minor changes may be considered.
- (c) The following documents are considered acceptable sources of information:
 - (1) AFM, supplements thereto, and documents directly referenced in the AFM;
 - (2) FCOM or similar document;
 - (3) Service Bulletin or Service Letter issued by the TC holder or STC holder;
 - (4) approved design data or data issued in support of a design change approval;
 - (5) any other formal document issued by the TC or STC holders stating compliance with PBN specifications, AMC, Advisory Circulars (AC) or similar documents issued by the State of Design; and
 - (6) written evidence obtained from the State of Design.
- (d) Equipment qualification data, in itself, is not sufficient to assess the PBN capabilities of the aircraft, since the latter depend on installation and integration.
- (e) As some PBN equipment and installations may have been certified prior to the publication of the PBN Manual and the adoption of its terminology for the navigation specifications, it is not always possible to find a clear statement of aircraft PBN capability in the AFM. However, aircraft eligibility for certain PBN specifications can rely on the aircraft performance certified for PBN procedures and routes prior to the publication of the PBN Manual.
- (f) Below, various references are listed which may be found in the AFM or other acceptable documents (see listing above) in order to consider the aircraft's eligibility for a specific PBN specification if the specific term is not used.
- (g) RNAV 5
 - (1) If a statement of compliance with any of the following specifications or standards is found in the acceptable documentation as listed above, the aircraft is eligible for RNAV 5 operations.
 - (i) B-RNAV;
 - (ii) RNAV 1;
 - (iii) RNP APCH;
 - (iv) RNP 4;
 - (v) A-RNP;
 - (vi) AMC 20-4;
 - (vii) JAA TEMPORARY GUIDANCE MATERIAL, LEAFLET NO. 2 (TGL 2);
 - (viii) JAA AMJ 20X2;
 - (ix) FAA AC 20-130A for en route operations;
 - (x) FAA AC 20-138 for en route operations; and

- (xi) FAA AC 90-96.
- (h) RNAV 1/RNAV 2
- (1) If a statement of compliance with any of the following specifications or standards is found in the acceptable documentation as listed above, the aircraft is eligible for RNAV 1/RNAV 2 operations.
 - (i) RNAV 1;
 - (ii) PRNAV;
 - (iii) US RNAV type A;
 - (iv) FAA AC 20-138 for the appropriate navigation specification;
 - (v) FAA AC 90-100A;
 - (vi) JAA TEMPORARY GUIDANCE MATERIAL, LEAFLET NO. 10 Rev1 (TGL 10); and
 - (vii) FAA AC 90-100.
- (2) However, if position determination is exclusively computed based on VOR-DME, the aircraft is not eligible for RNAV 1/RNAV 2 operations.
- (i) RNP 1/RNP 2 continental
 - (1) If a statement of compliance with any of the following specifications or standards is found in the acceptable documentation as listed above, the aircraft is eligible for RNP 1/RNP 2 continental operations.
 - (i) A-RNP;
 - (ii) FAA AC 20-138 for the appropriate navigation specification; and
 - (iii) FAA AC 90-105.
 - (2) Alternatively, if a statement of compliance with any of the following specifications or standards is found in the acceptable documentation as listed above and position determination is primarily based on GNSS, the aircraft is eligible for RNP 1/RNP 2 continental operations. However, in these cases, loss of GNSS implies loss of RNP 1/RNP 2 capability.
 - (i) JAA TEMPORARY GUIDANCE MATERIAL, LEAFLET NO. 10 (TGL 10) (any revision); and
 - (ii) FAA AC 90-100.
- (j) RNP APCH — LNAV minima
 - (1) If a statement of compliance with any of the following specifications or standards is found in the acceptable documentation as listed above, the aircraft is eligible for RNP APCH — LNAV operations.
 - (i) A-RNP;
 - (ii) AMC 20-27;
 - (iii) AMC 20-28;
 - (iv) FAA AC 20-138 for the appropriate navigation specification; and
 - (v) FAA AC 90-105 for the appropriate navigation specification.
 - (2) Alternatively, if a statement of compliance with RNP 0.3 GNSS approaches in accordance with any of the following specifications or standards is found in the acceptable

documentation as listed above, the aircraft is eligible for RNP APCH — LNAV operations. Any limitation such as ‘within the US National Airspace’ may be ignored since RNP APCH procedures are assumed to meet the same ICAO criteria around the world.

- (i) JAA TEMPORARY GUIDANCE MATERIAL, LEAFLET NO. 3 (TGL 3);
- (ii) AMC 20-4;
- (iii) FAA AC 20-130A; and
- (iv) FAA AC 20-138.

(k) RNP APCH — LNAV/VNAV minima

(1) If a statement of compliance with any of the following specifications or standards is found in the acceptable documentation as listed above, the aircraft is eligible for RNP APCH — LNAV/VNAV operations.

- (i) A-RNP;
- (ii) AMC 20-27 with Baro VNAV;
- (iii) AMC 20-28;
- (iv) FAA AC 20-138; and
- (v) FAA AC 90-105 for the appropriate navigation specification.

(2) Alternatively, if a statement of compliance with FAA AC 20-129 is found in the acceptable documentation as listed above, and the aircraft complies with the requirements and limitations of EASA SIB 2014-04¹⁰, the aircraft is eligible for RNP APCH — LNAV/VNAV operations. Any limitation such as ‘within the US National Airspace’ may be ignored since RNP APCH procedures are assumed to meet the same ICAO criteria around the world.

(l) RNP APCH — LPV minima

(1) If a statement of compliance with any of the following specifications or standards is found in the acceptable documentation as listed above, the aircraft is eligible for RNP APCH — LPV operations.

- (i) AMC 20-28;
- (ii) FAA AC 20-138 for the appropriate navigation specification; and
- (iii) FAA AC 90-107.

(2) For aircraft that have a TAWS Class A installed and do not provide Mode-5 protection on an LPV approach, the DH is limited to 250 ft.

(m) RNAV 10

(1) If a statement of compliance with any of the following specifications or standards is found in the acceptable documentation as listed above, the aircraft is eligible for RNAV 10 operations.

- (i) RNP 10;
- (ii) FAA AC 20-138 for the appropriate navigation specification;
- (iii) AMC 20-12;
- (iv) FAA Order 8400.12 (or later revision); and

¹⁰ <http://ad.easa.europa.eu/ad/2014-04>

- (v) FAA AC 90-105.
- (n) RNP 4
 - (1) If a statement of compliance with any of the following specifications or standards is found in the acceptable documentation as listed above, the aircraft is eligible for RNP 4 operations.
 - (i) FAA AC 20-138B or later, for the appropriate navigation specification;
 - (ii) FAA Order 8400.33; and
 - (iii) FAA AC 90-105 for the appropriate navigation specification.
- (o) RNP 2 oceanic
 - (1) If a statement of compliance with FAA AC 90-105 for the appropriate navigation specification is found in the acceptable documentation as listed above, the aircraft is eligible for RNP 2 oceanic operations.
 - (2) If the aircraft has been assessed eligible for RNP 4, the aircraft is eligible for RNP 2 oceanic.
- (p) Special features
 - (1) RF in terminal operations (used in RNP 1 and in the initial segment of the RNP APCH)
 - (i) If a statement of demonstrated capability to perform an RF leg, certified in accordance with any of the following specifications or standards, is found in the acceptable documentation as listed above, the aircraft is eligible for RF in terminal operations:
 - (A) AMC 20-26; and
 - (B) FAA AC 20-138B or later.
 - (ii) If there is a reference to RF and a reference to compliance with AC 90-105, then the aircraft is eligible for such operations.
- (q) Other considerations
 - (1) In all cases, the limitations in the AFM need to be checked; in particular, the use of AP or FD which can be required to reduce the FTE primarily for RNP APCH, RNAV 1, and RNP 1.
 - (2) Any limitation such as 'within the US National Airspace' may be ignored since RNP APCH procedures are assumed to meet the same ICAO criteria around the world.

GM3 CAT.IDE.H.345 Communication and navigation equipment for operations under IFR or under VFR over routes not navigated by reference to visual landmarks

GENERAL

- (a) The PBN specifications for which the aircraft complies with the relevant airworthiness criteria are set out in the AFM, together with any limitations to be observed.
- (b) Because functional and performance requirements are defined for each navigation specification, an aircraft approved for an RNP specification is not automatically approved for all RNAV specifications. Similarly, an aircraft approved for an RNP or RNAV specification having a stringent accuracy requirement (e.g. RNP 0.3 specification) is not automatically approved for a navigation specification having a less stringent accuracy requirement (e.g. RNP 4).

RNP 4

- (c) For RNP 4, at least two LRNSs, capable of navigating to RNP 4, and listed in the AFM, may be operational at the entry point of the RNP 4 airspace. If an item of equipment required for RNP 4 operations is unserviceable, then the flight crew may consider an alternate route or diversion for repairs. For multi-sensor systems, the AFM may permit entry if one GNSS sensor is lost after departure, provided one GNSS and one inertial sensor remain available.

CAT.IDE.H.350 Transponder

shall be equipped with a pressure altitude reporting secondary surveillance radar (SSR) transponder and any other SSR transponder capability required for the route being flown.

AMC1 CAT.IDE.H.350 Transponder

SSR TRANSPONDER

- (a) The secondary surveillance radar (SSR) transponders of aircraft being operated under European air traffic control should comply with any applicable Single European Sky legislation.
- (b) If the Single European Sky legislation is not applicable, the SSR transponders should operate in accordance with the relevant provisions of Volume IV of ICAO Annex 10.

CAT.IDE.H.355 Management of aeronautical databases

Applicable
from 01
January
2019

- (a) Aeronautical databases used on certified aircraft system applications shall meet data quality requirements that are adequate for the intended use of the data.
- (b) The operator shall ensure the timely distribution and insertion of current and unaltered aeronautical databases to all aircraft that require them.
- (c) Notwithstanding any other occurrence reporting requirements as defined in Regulation (EU) No 376/2014, the operator shall report to the database provider instances of erroneous, inconsistent or missing data that might be reasonably expected to constitute a hazard to flight.

In such cases, the operator shall inform flight crew and other personnel concerned, and shall ensure that the affected data is not used.

SECTION 3
Sailplanes**CAT.IDE.S.100 Instruments and equipment — general**

- (a) Instruments and equipment required by this Subpart shall be approved in accordance with Regulation (EU) No 748/2012 if they are:
- (1) used by the flight crew to control the flight path;
 - (2) used to comply with CAT.IDE.S.140;
 - (3) used to comply with CAT.IDE.S.145; or
 - (4) installed in the sailplane.
- (b) The following items, when required by this Subpart, do not need an equipment approval:
- (1) independent portable light;
 - (2) accurate time piece; and
 - (3) survival and signalling equipment.
- (c) Instruments and equipment not required by this Subpart as well as any other equipment that is not required by other Annexes, but is carried on a flight, shall comply with the following:
- (1) the information provided by these instruments or equipment shall not be used by the flight crew to comply with Annex I to Regulation (EC) No 216/2008; and
 - (2) the instruments and equipment shall not affect the airworthiness of the sailplane, even in the case of failures or malfunction.
- (d) Instruments and equipment shall be readily operable or accessible from the station where the flight crew member that needs to use it is seated.
- (e) All required emergency equipment shall be easily accessible for immediate use.

GM1 CAT.IDE.S.100(b) Instruments and equipment — general

REQUIRED INSTRUMENTS AND EQUIPMENT THAT DO NOT NEED TO BE APPROVED IN ACCORDANCE WITH COMMISSION REGULATION (EU) NO 748/2012

The functionality of non-installed instruments and equipment required by this Subpart and that do not need an equipment approval, as listed in CAT.IDE.S.100(b), should be checked against recognised industry standards appropriate to the intended purpose. The operator is responsible for ensuring the maintenance of these instruments and equipment.

GM1 CAT.IDE.S.100(c) Instruments and equipment — general

NOT REQUIRED INSTRUMENTS AND EQUIPMENT THAT DO NOT NEED TO BE APPROVED IN ACCORDANCE WITH COMMISSION REGULATION (EU) NO 748/2012, BUT ARE CARRIED ON A FLIGHT

- (a) The provision of this paragraph does not exempt any installed instrument or item of equipment from complying with Commission Regulation (EU) No 748/2012. In this case, the installation should be approved as required in Commission Regulation (EU) No 748/2012 and should comply with the applicable Certification Specifications.

- (b) The failure of additional non-installed instruments or equipment not required by this Part or by Commission Regulation (EU) No 748/2012 or any applicable airspace requirements should not adversely affect the airworthiness and/or the safe operation of the sailplane. Examples may be portable electronic devices carried by crew members or passengers.

CAT.IDE.S.105 Minimum equipment for flight

A flight shall not be commenced when any of the sailplane instruments, items of equipment or functions required for the intended flight are inoperative or missing, unless the sailplane is operated in accordance with the minimum equipment list (MEL).

CAT.IDE.S.110 Operations under VFR — flight and navigational instruments

- (a) Sailplanes operated under VFR by day shall be equipped with a means of measuring and displaying:
- (1) in the case of powered sailplanes, magnetic heading;
 - (2) time in hours, minutes and seconds;
 - (3) pressure altitude; and
 - (4) indicated airspeed.
- (b) Sailplanes operating in conditions where the sailplane cannot be maintained in a desired attitude without reference to one or more additional instruments, shall be, in addition to (a), equipped with a means of measuring and displaying:
- (1) vertical speed;
 - (2) attitude or turn and slip; and
 - (3) magnetic heading.

AMC1 CAT.IDE.S.110 & CAT.IDE.S.115 Operations under VFR & cloud flying — flight and navigational instruments

INTEGRATED INSTRUMENTS

- (a) Individual equipment requirements may be met by combinations of instruments or by integrated flight systems or by a combination of parameters on electronic displays. The information so available to each required pilot should not be less than that required in the applicable operational requirements, and the equivalent safety of the installation should be approved during type certification of the sailplane for the intended type of operation.
- (b) The means of measuring and indicating turn and slip and sailplane attitude may be met by combinations of instruments, provided that the safeguards against total failure, inherent in the three separate instruments, are retained.

AMC1 CAT.IDE.S.110(a)(1) & CAT.IDE.S.115(a) Operations under VFR & cloud flying — flight and navigational instruments

MEANS OF MEASURING AND DISPLAYING MAGNETIC HEADING

The means of measuring and displaying magnetic heading should be a magnetic compass or equivalent.

AMC1 CAT.IDE.S.110(a)(2) & CAT.IDE.S.115(b) Operations under VFR & cloud flying — flight and navigational instruments

MEANS OF MEASURING AND DISPLAYING THE TIME

A means of measuring and displaying the time in hours, minutes and seconds may be a wrist watch capable of the same functions.

AMC1 CAT.IDE.S.110(a)(3) & CAT.IDE.S.115(c) Operations under VFR & cloud flying — flight and navigational instruments

CALIBRATION OF THE MEANS FOR MEASURING AND DISPLAYING PRESSURE ALTITUDE

- (a) The instrument measuring and displaying pressure altitude should be of a sensitive type calibrated in feet (ft), with a sub-scale setting, calibrated in hectopascals/millibars, adjustable for any barometric pressure likely to be set during flight.
- (b) Calibration in metres (m) is also acceptable.

AMC1 CAT.IDE.S.110(a)(4) & CAT.IDE.S.115(d) Operations under VFR & cloud flying — flight and navigational instruments

CALIBRATION OF THE INSTRUMENT INDICATING AIRSPEED

- (a) The instrument indicating airspeed should be calibrated in knots (kt).
- (b) Calibration in kilometres per hour (kph) or in miles per hour (mph) is also acceptable.

GM1 CAT.IDE.S.110(b) Operations under VFR — flight and navigational instruments

CONDITIONS WHERE THE SAILPLANE CANNOT BE MAINTAINED IN A DESIRED ATTITUDE WITHOUT REFERENCE TO ONE OR MORE ADDITIONAL INSTRUMENTS

Sailplanes operating in conditions where the sailplane cannot be maintained in a desired attitude without reference to one or more additional instruments means a condition that is still under VFR (under VMC) though where there is no external reference such as the natural horizon or a coastline, that would allow the attitude to be maintained. Such conditions may occur over water, a desert or snow-covered areas where the colour of the surface cannot be distinguished from the colour of the sky and, therefore, no external reference is available. Cloud flying is not considered to be one of these conditions.

CAT.IDE.S.115 Cloud flying — flight and navigational instruments

Sailplanes performing cloud flying shall be equipped with a means of measuring and displaying:

- (a) magnetic heading;
- (b) time in hours, minutes and seconds;
- (c) pressure altitude;
- (d) indicated airspeed;
- (e) vertical speed; and
- (f) attitude or turn and slip.

AMC1 CAT.IDE.S.110 & CAT.IDE.S.115 Operations under VFR & cloud flying — flight and navigational instruments

See [here](#).

AMC1 CAT.IDE.S.110(a)(1) & CAT.IDE.S.115(a) Operations under VFR & cloud flying — flight and navigational instruments

See [here](#).

AMC1 CAT.IDE.S.110(a)(2) & CAT.IDE.S.115(b) Operations under VFR & cloud flying — flight and navigational instruments

See [here](#).

AMC1 CAT.IDE.S.110(a)(3) & CAT.IDE.S.115(c) Operations under VFR & cloud flying — flight and navigational instruments

See [here](#).

AMC1 CAT.IDE.S.110(a)(4) & CAT.IDE.S.115(d) Operations under VFR & cloud flying — flight and navigational instruments

See [here](#).

CAT.IDE.S.120 Seats and restraint systems

- (a) Sailplanes shall be equipped with:
 - (1) a seat for each person on board; and
 - (2) a seat belt with upper torso restraint system for each seat according to the AFM.
- (b) A seat belt with upper torso restraint system shall have a single point release.

AMC1 CAT.IDE.S.120 Seats and restraint systems

UPPER TORSO RESTRAINT SYSTEM

- (a) A seat belt with upper torso restraint system should have four anchorage points and should include shoulder straps (two anchorage points) and a seat belt (two anchorage points), which may be used independently.
- (b) A restraint system having five anchorage points is deemed to be compliant to the requirement for seat belt with upper torso restraint system with four anchorage points.

CAT.IDE.S.125 Supplemental oxygen

Sailplanes operated at pressure altitudes above 10 000 ft shall be equipped with oxygen storage and dispensing apparatus carrying enough breathing oxygen to supply:

- (a) crew members for any period in excess of 30 minutes when the pressure altitude will be between 10 000 ft and 13 000 ft; and
- (b) all crew members and passengers for any period that the pressure altitude will be above 13 000 ft.

CAT.IDE.S.130 Flight over water

The commander of a sailplane operated over water shall determine the risks to survival of the occupants of the sailplane in the event of a ditching, based on which he/she shall determine the carriage of:

- (a) a life-jacket, or equivalent individual floatation device, for each person on board, that shall be worn or stowed in a position that is readily accessible from the seat of the person for whose use it is provided;
- (b) an emergency locator transmitter (ELT) or a personal locator beacon (PLB), carried by a crew member or a passenger, capable of transmitting simultaneously on 121,5 MHz and 406 MHz; and
- (c) equipment for making distress signals, when operating a flight:
 - (1) over water beyond gliding distance from the land; or
 - (2) where the take-off or approach path is so disposed over water that in the event of a mishap there would be a likelihood of ditching.

AMC1 CAT.IDE.S.130 Flight over water

RISK ASSESSMENT

- (a) When conducting the risk assessment, the commander should base his/her decision, as far as is practicable, on the Implementing Rules and AMCs applicable to the operation of the sailplane.
- (b) The commander should, for determining the risk, take the following operating environment and conditions into account:
 - (1) sea state;
 - (2) sea and air temperatures;
 - (3) the distance from land suitable for making an emergency landing; and
 - (4) the availability of search and rescue facilities.

AMC1 CAT.IDE.S.130(a) Flight over water

MEANS OF ILLUMINATION FOR LIFE-JACKETS

Each life-jacket or equivalent individual floatation device should be equipped with a means of electric illumination for the purpose of facilitating the location of persons.

GM1 CAT.IDE.S.130(a) Flight over water

SEAT CUSHIONS

Seat cushions are not considered to be flotation devices.

AMC1 CAT.IDE.S.130(b) Flight over water

BATTERIES

- (a) All batteries used in ELTs or PLBs should be replaced (or recharged, if the battery is rechargeable) when the equipment has been in use for more than 1 cumulative hour or in the following cases:
- (1) Batteries specifically designed for use in ELTs and having an airworthiness release certificate (EASA Form 1 or equivalent) should be replaced (or recharged, if the battery is rechargeable) before the end of their useful life in accordance with the maintenance instructions applicable to the ELT.
 - (2) Standard batteries manufactured in accordance with an industry standard and not having an airworthiness release certificate (EASA Form 1 or equivalent), when used in ELTs should be replaced (or recharged, if the battery is rechargeable) when 50 % of their useful life (or for rechargeable, 50 % of their useful life of charge), as established by the battery manufacturer, has expired.
 - (3) All batteries used in PLBs should be replaced (or recharged if the battery is rechargeable) when 50 % of their useful life (or for rechargeable 50 % of their useful life of charge), as established by the battery manufacturer, has expired.
 - (4) The battery useful life (or useful life of charge) criteria in (1),(2) and (3) do not apply to batteries (such as water-activated batteries) that are essentially unaffected during probable storage intervals.
- (b) The new expiry date for a replaced (or recharged) battery should be legibly marked on the outside of the equipment.

AMC2 CAT.IDE.S.130(b) Flight over water

TYPES OF ELT AND GENERAL TECHNICAL SPECIFICATIONS

- (a) The ELT required by this provision should be one of the following:
- (1) Automatic fixed (ELT(AF)). An automatically activated ELT that is permanently attached to an aircraft and is designed to aid search and rescue (SAR) teams in locating the crash site.
 - (2) Automatic portable (ELT(AP)). An automatically activated ELT that is rigidly attached to an aircraft before a crash, but is readily removable from the aircraft after a crash. It functions as an ELT during the crash sequence. If the ELT does not employ an integral antenna, the aircraft-mounted antenna may be disconnected and an auxiliary antenna (stored in the ELT case) attached to the ELT. The ELT can be tethered to a survivor or a life-raft. This type of ELT is intended to aid SAR teams in locating the crash site or survivor(s).
 - (3) Automatic deployable (ELT(AD)). An ELT that is rigidly attached to the aircraft before the crash and that is automatically ejected, deployed and activated by an impact, and, in some cases, also by hydrostatic sensors. Manual deployment is also provided. This type of ELT should float in water and is intended to aid SAR teams in locating the crash site.
 - (4) Survival ELT (ELT(S)). An ELT that is removable from an aircraft, stowed so as to facilitate its ready use in an emergency and manually activated by a survivor. An ELT(S) may be activated manually or automatically (e.g. by water activation). It should be designed to be tethered to a life-raft or a survivor.
- (b) To minimise the possibility of damage in the event of crash impact, the automatic ELT should be rigidly fixed to the aircraft structure, as far aft as is practicable, with its antenna and connections arranged so as to maximise the probability of the signal being transmitted after a crash.

- (c) Any ELT carried should operate in accordance with the relevant provisions of ICAO Annex 10, Volume III communication systems and should be registered with the national agency responsible for initiating search and rescue or other nominated agency.

AMC3 CAT.IDE.S.130(b) Flight over water

PLB TECHNICAL SPECIFICATIONS

- (a) A personal locator beacon (PLB) should have a built-in GNSS receiver with a *cosmicheskaya sistyema poiska avariynich sudov* — search and rescue satellite-aided tracking (COSPAS-SARSAT) type approval number. However, devices with a COSPAS-SARSAT number belonging to series 700 are excluded as this series of numbers identifies the special-use beacons not meeting all the technical requirements and all the tests specified by COSPAS-SARSAT.
- (b) Any PLB carried should be registered with the national agency responsible for initiating search and rescue or other nominated agency.

AMC4 CAT.IDE.S.130(b) Flight over water

BRIEFING ON PLB USE

When a PLB is carried by a passenger, he/she should be briefed on its characteristics and use by the commander before the flight.

GM1 CAT.IDE.S.130(b) Flight over water

TERMINOLOGY

- (a) 'ELT' is a generic term describing equipment that broadcasts distinctive signals on designated frequencies and, depending on application, may be activated by impact or may be manually activated.
- (b) A PLB is an emergency beacon other than an ELT that broadcasts distinctive signals on designated frequencies, is standalone, portable and is manually activated by the survivors.

CAT.IDE.S.135 Survival equipment

Sailplanes operated over areas in which search and rescue would be especially difficult shall be equipped with such signalling devices and life-saving equipment as appropriate to the area overflown.

AMC1 CAT.IDE.S.135 Survival Equipment

GENERAL

Sailplanes operated across land areas in which search and rescue would be especially difficult should be equipped with the following:

- (a) signalling equipment to make the distress signals;
- (b) at least one ELT(S) or a PLB; and
- (c) additional survival equipment for the route to be flown taking account of the number of persons on board.

AMC2 CAT.IDE.S.135 Survival equipment

ADDITIONAL SURVIVAL EQUIPMENT

- (a) The following additional survival equipment should be carried when required:
 - (1) 500 ml of water;
 - (2) one knife;
 - (3) first-aid equipment; and
 - (4) one set of air/ground codes.
- (b) If any item of equipment contained in the above list is already carried on board the sailplane in accordance with another requirement, there is no need for this to be duplicated.

GM1 CAT.IDE.S.135 Survival equipment

SIGNALLING EQUIPMENT

The signalling equipment for making distress signals is described in ICAO Annex 2, Rules of the Air.

GM2 CAT.IDE.S.135 Survival equipment

AREAS IN WHICH SEARCH AND RESCUE WOULD BE ESPECIALLY DIFFICULT

The expression 'areas in which search and rescue would be especially difficult' should be interpreted, in this context, as meaning:

- (a) areas so designated by the authority responsible for managing search and rescue; or
- (b) areas that are largely uninhabited and where:
 - (1) the authority referred to in (a) has not published any information to confirm whether search and rescue would be or would not be especially difficult; and
 - (2) the authority referred to in (a) does not, as a matter of policy, designate areas as being especially difficult for search and rescue.

CAT.IDE.S.140 Radio communication equipment

- (a) When required by the airspace being flown, sailplanes shall be equipped with radio communication equipment capable of conducting two-way communication with those aeronautical stations or those frequencies to meet airspace requirements.
- (b) Radio communication equipment, if required by (a), shall provide for communication on the aeronautical emergency frequency 121,5 MHz.

CAT.IDE.S.145 Navigation equipment

Sailplanes shall be equipped with any navigation equipment necessary to proceed in accordance with:

- (a) the ATS flight plan if applicable; and
- (b) the applicable airspace requirements.

GM1 CAT.IDE.S.145 Navigation equipment**APPLICABLE AIRSPACE REQUIREMENTS**

For sailplanes being operated under European air traffic control, the applicable airspace requirements include the Single European Sky legislation.

CAT.IDE.S.150 Transponder

When required by the airspace being flown, sailplanes shall be equipped with a secondary surveillance radar (SSR) transponder with all the required capabilities.

AMC1 CAT.IDE.S.150 Transponder

GENERAL

- (a) The SSR transponders of sailplanes being operated under European air traffic control should comply with any applicable Single European Sky legislation.
- (b) If the Single European Sky legislation is not applicable, the SSR transponders should be operated in accordance with the relevant provisions of Volume IV of ICAO Annex 10.

SECTION 4
Balloons**CAT.IDE.B.100 Instruments and equipment — general**

- (a) Instruments and equipment required by this Subpart shall be approved in accordance with Regulation (EC) No 748/2012 if they are:
- (1) used by the flight crew to determine the flight path;
 - (2) used to comply with CAT.IDE.B.155; or
 - (3) installed in the balloon.
- (b) The following items, when required by this Subpart, do not need an equipment approval:
- (1) independent portable light;
 - (2) accurate time piece;
 - (3) first-aid kit;
 - (4) survival and signalling equipment;
 - (5) alternative source of ignition;
 - (6) fire blanket or fire resistant cover;
 - (7) drop line; and
 - (8) knife.
- (c) Instruments and equipment not required by this Subpart as well as any other equipment that is not required by other Annexes, but is carried on a flight, shall comply with the following:
- (1) the information provided by these instruments or equipment shall not be used by the flight crew to comply with Annex I to Regulation (EC) No 216/2008; and
 - (2) the instruments and equipment shall not affect the airworthiness of the balloon, even in the case of failures or malfunction.
- (d) Instruments and equipment shall be readily operable or accessible from the station where the flight crew member that needs to use it is assigned.
- (e) All required emergency equipment shall be easily accessible for immediate use.

GM1 CAT.IDE.B.100(b) Instruments and equipment — general

REQUIRED INSTRUMENTS AND EQUIPMENT THAT DO NOT NEED TO BE APPROVED IN ACCORDANCE WITH COMMISSION REGULATION (EU) NO 748/2012

The functionality of non-installed instruments and equipment required by this Subpart and that do not need an equipment approval, as listed in CAT.IDE.B.100(b), should be checked against recognised industry standards appropriate to the intended purpose. The operator is responsible for ensuring the maintenance of these instruments and equipment.

GM1 CAT.IDE.B.100(c) Instruments and equipment — general

NOT REQUIRED INSTRUMENTS AND EQUIPMENT THAT DO NOT NEED TO BE APPROVED IN ACCORDANCE WITH COMMISSION REGULATION (EU) NO 748/2012, BUT ARE CARRIED ON A FLIGHT

- (a) The provision of this paragraph does not exempt any installed instrument or item of equipment from complying with Commission Regulation (EU) No 748/2012. In this case, the installation should be approved as required in Commission Regulation (EU) No 748/2012 and should comply with the applicable Certification Specifications.
- (b) The failure of additional non-installed instruments or equipment not required by this Part or by Commission Regulation (EU) No 748/2012 or any applicable airspace requirements should not adversely affect the airworthiness and/or the safe operation of the balloon. Examples may be portable electronic devices carried by crew members or passengers.

CAT.IDE.B.105 Minimum equipment for flight

A flight shall not be commenced when any of the balloon instruments, items of equipment or functions, required for the intended flight, are inoperative, unless the balloon is operated in accordance with the minimum equipment list (MEL).

CAT.IDE.B.110 Operating lights

Balloons operated at night shall be equipped with:

- (a) anti-collision lights;
- (b) a means to provide adequate illumination for all instruments and equipment essential to the safe operation of the balloon; and
- (c) an independent portable light.

AMC1 CAT.IDE.B.110 Operating lights**ANTI-COLLISION LIGHTS**

An acceptable means of compliance is the anti-collision light required for free manned balloons certified for VFR at night in accordance with CS 31HB/GB.

ILLUMINATION FOR INSTRUMENTS AND EQUIPMENT

A means to provide adequate illumination to instruments and equipment essential to the safe operation of the balloon may be an independent portable light.

CAT.IDE.B.115 Operations under VFR — flight and navigational instruments and associated equipment

Balloons operated under VFR shall be equipped with:

- (a) a means of displaying drift direction; and
- (b) a means of measuring and displaying:
 - (1) time in hours, minutes and seconds;
 - (2) vertical speed, if required by the AFM;
 - (3) pressure altitude, if required by the AFM, if required by air space requirements or when altitude needs to be controlled for the use of oxygen; and
 - (4) except for gas balloons, the pressure of each burning gas supply line.

AMC1 CAT.IDE.B.115(a) Operations under VFR — flight and navigational instruments**MEANS OF DISPLAYING DRIFT DIRECTION**

The drift direction may be determined by using a map and reference to visual landmarks.

AMC1 CAT.IDE.B.115(b)(1) Operations under VFR — flight and navigational instruments**MEANS OF MEASURING AND DISPLAYING THE TIME**

A means of measuring and displaying the time in hours, minutes and seconds may be a wrist watch capable of the same functions.

GM1 CAT.IDE.B.115(b)(2) Operations under VFR — flight and navigational instruments**MEANS OF MEASURING AND DISPLAYING VERTICAL SPEED**

The necessity of a vertical speed indicator depends on the balloon design. Some envelope shapes have a high drag and will, therefore, not develop a high ascent/descent speed. Such balloons usually do not require a vertical speed indicator. More slender envelope shapes such as special shape balloons may have a significantly lower drag. Their ascent/descent speed is usually limited to a certain value so that controllability of the balloon is maintained. To be able to stay within this limitation of the AFM, a vertical speed indicator is required for these balloons.

GM1 CAT.IDE.B.115(b)(3) Operations under VFR — flight and navigational instruments and associated equipment**MEANS OF MEASURING AND DISPLAYING PRESSURE ALTITUDE**

A means of measuring and displaying pressure altitude is needed when required by ATC or by Commission Implementing Regulation (EU) No 923/2012¹¹, or when altitude needs to be checked for flights where oxygen is used, or the limitations in the AFM require to limit altitude and/or rate of climb/descent.

¹¹ Commission Implementing Regulation (EU) No 923/2012 of 26 September 2012 laying down the common rules of the air and operational provisions regarding services and procedures in air navigation and amending Implementing Regulation (EU) No 1035/2011 and Regulations (EC) No 1265/2007, (EC) No 1794/2006, (EC) No 730/2006, (EC) No 1033/2006 and (EU) No 255/2010 (OJ L 281, 13.10.2012, p. 1).

CAT.IDE.B.120 Restraint systems

Balloons with a separate compartment for the commander shall be equipped with a restraint system for the commander.

AMC1 CAT.IDE.B.120 Restraint systems

GENERAL

A pilot restraint harness mounted to the basket is considered to meet the objective of CAT.IDE.B.120.

CAT.IDE.B.125 First-aid kit

- (a) Balloons shall be equipped with a first-aid kit.
- (b) An additional first-aid kit shall be carried in the retrieve vehicle.
- (c) The first-aid kit shall be:
 - (1) readily accessible for use; and
 - (2) kept up-to-date.

AMC1 CAT.IDE.B.125 First-aid kit

CONTENT OF FIRST-AID KITS

- (a) First-aid kits should be equipped with appropriate and sufficient medications and instrumentation. However, these kits should be amended by the operator according to the characteristics of the operation (scope of operation, flight duration, number and demographics of passengers, etc.).
- (b) The following should be included in the FAKs:
 - (1) bandages (assorted sizes),
 - (2) burns dressings (large and small),
 - (3) wound dressings (large and small),
 - (4) adhesive dressings (assorted sizes),
 - (5) antiseptic wound cleaner,
 - (6) safety scissors, and
 - (7) disposable gloves.

AMC2 CAT.IDE.B.125 First-aid kit

MAINTENANCE OF FIRST-AID KIT

To be kept up to date, first-aid kits should be:

- (a) inspected periodically to confirm, to the extent possible, that contents are maintained in the condition necessary for their intended use;
- (b) replenished at regular intervals, in accordance with instructions contained on their labels, or as circumstances warrant; and
- (c) replenished after use in-flight at the first opportunity where replacement items are available.

CAT.IDE.B.130 Supplemental oxygen

Balloons operated at pressure altitudes above 10 000 ft shall be equipped with oxygen storage and dispensing apparatus carrying enough breathing oxygen to supply:

- (a) crew members for any period in excess of 30 minutes when the pressure altitude will be between 10 000 ft and 13 000 ft; and
- (b) all crew members and passengers for any period that the pressure altitude will be above 13 000 ft.

CAT.IDE.B.135 Hand fire extinguishers

Hot-air balloons shall be equipped with at least one hand fire extinguisher as required by the applicable airworthiness code.

AMC1 CAT.IDE.B.135 Hand fire extinguishers**CERTIFICATION SPECIFICATION**

The applicable Certification Specification for hot-air balloons should be CS-31HB or equivalent.

CAT.IDE.B.140 Flight over water

The commander of a balloon operated over water shall determine the risks to survival of the occupants of the balloon in the event of a ditching, based on which he/she shall determine the carriage of:

- (a) a life-jacket for each person on board, or equivalent individual floatation device for each person on board younger than 24 months, that shall be worn or stowed in a position that is readily accessible from the station of the person for whose use it is provided;
- (b) an emergency locator transmitter (ELT) or a personal locator beacon (PLB), carried by a crew member or a passenger, capable of transmitting simultaneously on 121,5 MHz and 406 MHz; and
- (c) equipment for making distress signals.

AMC1 CAT.IDE.B.140 Flight over water

RISK ASSESSMENT

- (a) When conducting the risk assessment, the commander should base his/her decision, as far as is practicable, on the Implementing Rules and AMCs applicable to the operation of the balloon.
- (b) The commander should, for determining the risk, take the following operating environment and conditions into account:
 - (1) sea state;
 - (2) sea and air temperatures;
 - (3) the distance from land suitable for making an emergency landing; and
 - (4) the availability of search and rescue facilities.

AMC1 CAT.IDE.B.140(a) Flight over water

MEANS OF ILLUMINATION FOR LIFE-JACKETS

Each life-jacket or equivalent individual flotation device should be equipped with a means of electric illumination for the purpose of facilitating the location of persons.

AMC1 CAT.IDE.B.140(b) Flight over water

BATTERIES

- (a) All batteries used in ELTs or PLBs should be replaced (or recharged if the battery is rechargeable) when the equipment has been in use for more than 1 cumulative hour or in the following cases:
 - (1) Batteries specifically designed for use in ELTs and having an airworthiness release certificate (EASA Form 1 or equivalent) should be replaced (or recharged if the battery is rechargeable) before the end of their useful life in accordance with the maintenance instructions applicable to the ELT.
 - (2) Standard batteries manufactured in accordance with an industry standard and not having an airworthiness release certificate (EASA Form 1 or equivalent), when used in ELTs should be replaced (or recharged if the battery is rechargeable) when 50 % of their useful life (or for rechargeable, 50 % of their useful life of charge), as established by the battery manufacturer, has expired.

- (3) All batteries used in PLBs should be replaced (or recharged, if the battery is rechargeable) when 50 % of their useful life (or for rechargeable, 50 % of their useful life of charge), as established by the battery manufacturer, has expired.
 - (4) The battery useful life (or useful life of charge) criteria in (1),(2) and (3) do not apply to batteries (such as water-activated batteries) that are essentially unaffected during probable storage intervals.
- (b) The new expiry date for a replaced (or recharged) battery should be legibly marked on the outside of the equipment.

AMC2 CAT.IDE.B.140(b) Flight over water

TYPES OF ELT AND GENERAL TECHNICAL SPECIFICATIONS

- (a) The ELT required by this provision should be one of the following:
- (1) Automatic fixed (ELT(AF)). An automatically activated ELT that is permanently attached to an aircraft and is designed to aid search and rescue (SAR) teams in locating the crash site.
 - (2) Automatic portable (ELT(AP)). An automatically activated ELT that is rigidly attached to an aircraft before a crash, but is readily removable from the aircraft after a crash. It functions as an ELT during the crash sequence. If the ELT does not employ an integral antenna, the aircraft-mounted antenna may be disconnected and an auxiliary antenna (stored in the ELT case) attached to the ELT. The ELT can be tethered to a survivor or a -raft. This type of ELT is intended to aid SAR teams in locating the crash site or survivor(s).
 - (3) Automatic deployable (ELT(AD)). An ELT that is rigidly attached to the aircraft before the crash and which is automatically ejected, deployed and activated by an impact, and, in some cases, also by hydrostatic sensors. Manual deployment is also provided. This type of ELT should float in water and is intended to aid SAR teams in locating the crash site.
 - (4) Survival ELT (ELT(S)). An ELT that is removable from an aircraft, stowed so as to facilitate its ready use in an emergency and manually activated by a survivor. An ELT(S) may be activated manually or automatically (e.g. by water activation). It should be designed to be tethered to a life-raft or a survivor.
- (b) To minimise the possibility of damage in the event of crash impact, the automatic ELT should be rigidly fixed to the aircraft structure, with its antenna and connections arranged so as to maximise the probability of the signal being transmitted after a crash.
- (c) Any ELT carried should operate in accordance with the relevant provisions of ICAO Annex 10, Volume III communication systems and should be registered with the national agency responsible for initiating search and rescue or other nominated agency.

AMC3 CAT.IDE.B.140(b) Flight over water

PLB TECHNICAL SPECIFICATIONS

- (a) A personal locator beacon (PLB) should have a built-in GNSS receiver with a *cosmicheskaya sistyema poiska avarynich sudov* — search and rescue satellite-aided tracking (COSPAS-SARSAT) type approval number. However, devices with a COSPAS-SARSAT number belonging to series 700 are excluded as this series of numbers identifies the special-use beacons not meeting all the technical requirements and all the tests specified by COSPAS-SARSAT.
- (b) Any PLB carried should be registered with the national agency responsible for initiating search and rescue or other nominated agency.

AMC4 CAT.IDE.B.140(b) Flight over water

BRIEFING ON PLB USE

When a PLB is carried by a passenger, he/she should be briefed on its characteristics and use by the commander before the flight.

GM1 CAT.IDE.B.140(b) Flight over water

TERMINOLOGY

- (a) 'ELT' is a generic term describing equipment that broadcasts distinctive signals on designated frequencies and, depending on application, may be activated by impact or may be manually activated.
- (b) A PLB is an emergency beacon other than an ELT that broadcasts distinctive signals on designated frequencies, is standalone, portable and is manually activated by the survivors.

GM1 CAT.IDE.B.140(c) Flight over water

SIGNALLING EQUIPMENT

The signalling equipment for making distress signals is described in ICAO Annex 2, Rules of the Air.

CAT.IDE.B.145 Survival equipment

Balloons operated over areas in which search and rescue would be especially difficult shall be equipped with such signalling devices and life-saving equipment as appropriate to the area overflown.

AMC1 CAT.IDE.B.145 Survival equipment

GENERAL

Balloons operated across land areas in which search and rescue would be especially difficult should be equipped with the following:

- (a) signalling equipment to make the distress signals;
- (b) at least one ELT(S) or a PLB; and
- (c) additional survival equipment for the route to be flown taking account of the number of persons on board.

AMC2 CAT.IDE.B.145 Survival equipment

ADDITIONAL SURVIVAL EQUIPMENT

- (a) The following additional survival equipment should be carried when required:
 - (1) 500 ml of water for each four, or fraction of four, persons on board;
 - (2) one knife;
 - (3) first-aid equipment; and
 - (4) one set of air/ground codes.
- (b) If any item of equipment contained in the above list is already carried on board the balloon in accordance with another requirement, there is no need for this to be duplicated.

GM1 CAT.IDE.B.145 Survival equipment

SIGNALLING EQUIPMENT

The signalling equipment for making distress signals is described in ICAO Annex 2, Rules of the Air.

GM2 CAT.IDE.B.145 Survival equipment

AREAS IN WHICH SEARCH AND RESCUE WOULD BE ESPECIALLY DIFFICULT

The expression 'areas in which search and rescue would be especially difficult' should be interpreted, in this context, as meaning:

- (a) areas so designated by the authority responsible for managing search and rescue; or
- (b) areas that are largely uninhabited and where:
 - (1) the authority referred to in (a) has not published any information to confirm whether search and rescue would be or would not be especially difficult; and
 - (2) the authority referred to in (a) does not, as a matter of policy, designate areas as being especially difficult for search and rescue.

CAT.IDE.B.150 Miscellaneous equipment

- (a) Balloons shall be equipped with protective gloves for each crew member.
- (b) Hot-air balloons shall be equipped with:
 - (1) an alternative source of ignition;
 - (2) a means of measuring and indicating fuel quantity;
 - (3) a fire blanket or fire resistant cover; and
 - (4) a drop line of at least 25 m in length.
- (c) Gas balloons shall be equipped with:
 - (1) a knife; and
 - (2) a drop line of at least 20 m in length made of natural fibre or electrostatic conductive material.

AMC1 CAT.IDE.B.150(b)(3) Miscellaneous equipment**FIRE BLANKET**

A fire blanket should comply with EN 1869 or equivalent. The size should be at least 1.5 m x 2 m. Smaller sizes are not recommended as they cannot sufficiently cover the source of developing propane fire.

AMC1 CAT.IDE.B.150(c)(1) Miscellaneous equipment**KNIFE**

The knife, hook knife or equivalent, should be capable of cutting any control line or handling rope that is accessible to the commander or a crew member from the basket.

CAT.IDE.B.155 Radio communication equipment

- (a) When required by airspace requirements, balloons shall be equipped with radio communication equipment at the pilot's station, capable of conducting two-way communication with those aeronautical stations or those frequencies to meet airspace requirements.
- (b) Radio communication equipment, if required by (a), shall provide for communication on the aeronautical emergency frequency 121,5 MHz.

GM1 CAT.IDE.B.155 Radio communication equipment**APPLICABLE AIRSPACE REQUIREMENTS**

For balloons being operated under European air traffic control, the applicable airspace requirements include the Single European Sky legislation.

CAT.IDE.B.160 Transponder

When required by the airspace being flown, balloons shall be equipped with a secondary surveillance radar (SSR) transponder with all the required capabilities.

AMC1 CAT.IDE.B.160 Transponder

GENERAL

- (a) The SSR transponders of balloons being operated under European air traffic control should comply with any applicable Single European Sky legislation.
- (b) If the Single European Sky legislation is not applicable, the SSR transponders should operate in accordance with the relevant provisions of Volume IV of ICAO Annex 10.

ANNEX V

Specific Approvals

[Part-SPA]

SUBPART A: GENERAL REQUIREMENTS

SPA.GEN.100 Competent authority

- (a) The competent authority for issuing a specific approval shall be:
- (1) for the commercial operator the authority of the Member State in which the operator has its principal place of business;
 - (2) for the non-commercial operator the authority of the State in which the operator is established or residing.
- (b) Notwithstanding (a)(2), for the non-commercial operator using aircraft registered in a third country, the applicable requirements under this Annex for the approval of the following operations shall not apply if these approvals are issued by a third country State of Registry:
- (1) Performance-based navigation (PBN);
 - (2) Minimum operational performance specifications (MNPS);
 - (3) Reduced vertical separation minima (RVSM) airspace.

SPA.GEN.105 Application for a specific approval

- (a) The operator applying for the initial issue of a specific approval shall provide to the competent authority the documentation required in the applicable Subpart, together with the following information:
- (1) the name, address and mailing address of the applicant;
 - (2) a description of the intended operation.
- (b) The operator shall provide the following evidence to the competent authority:
- (1) compliance with the requirements of the applicable Subpart;
 - (2) that the relevant elements defined in the mandatory part of the operational suitability data established in accordance with Regulation (EU) No 748/2012 are taken into account.
- (c) The operator shall retain records relating to (a) and (b) at least for the duration of the operation requiring a specific approval, or, if applicable, in accordance with Annex III (Part-ORO).

AMC1 SPA.GEN.105(a) Application for a specific approval

DOCUMENTATION

- (a) Operating procedures should be documented in the operations manual.

- (b) If an operations manual is not required, operating procedures may be described in a manual specifying procedures (procedures manual). If the aircraft flight manual (AFM) or the pilot operating handbook (POH) contains such procedures, they should be considered as acceptable means to document the procedures.

SPA.GEN.110 Privileges of an operator holding a specific approval

The scope of the activity that an operator is approved to conduct shall be documented and specified:

- (a) for operators holding an air operator certificate (AOC) in the operations specifications to the AOC;
- (b) for all other operators in the list of specific approvals.

SPA.GEN.115 Changes to a specific approval

When the conditions of a specific approval are affected by changes, the operator shall provide the relevant documentation to the competent authority and obtain prior approval for the operation.

SPA.GEN.120 Continued validity of a specific approval

Specific approvals shall be issued for an unlimited duration and shall remain valid subject to the operator remaining in compliance with the requirements associated with the specific approval and taking into account the relevant elements defined in the mandatory part of the operational suitability data established in accordance with Regulation (EU) No 748/2012.

SUBPART B: PERFORMANCE-BASED NAVIGATION (PBN) OPERATIONS

SPA.PBN.100 PBN operations

- a) An approval is required for each of the following PBN specifications:
 - (1) RNP AR APCH; and
 - (2) RNP 0.3 for helicopter operation.
- (b) An approval for RNP AR APCH operations shall allow operations on public instrument approach procedures which meet the applicable ICAO procedure design criteria.
- (c) A procedure-specific approval for RNP AR APCH or RNP 0.3 shall be required for private instrument approach procedures or any public instrument approach procedure that does not meet the applicable ICAO procedure design criteria, or where required by the Aeronautical Information Publication (AIP) or the competent authority.

GM1 SPA.PBN.100 PBN operations

GENERAL

- (a) PBN operations are based on performance requirements, which are expressed in navigation specifications (RNAV specification and RNP specification) in terms of accuracy, integrity, continuity, availability and functionality needed for the proposed operation in the context of a particular airspace concept.

Table 1 provides a simplified overview of:

 - (1) PBN specifications and their applicability for different phases of flight; and
 - (2) PBN specifications requiring a specific approval.
- (b) More detailed guidance material for the operational use of PBN applications can be found in ICAO Doc 9613 Performance-Based Navigation (PBN) Manual.
- (c) Guidance material for the design of RNP AR APCH procedures can be found in ICAO Doc 9905 RNP AR Procedure Design Manual.
- (d) Guidance material for the operational approval of PBN operations can be found in ICAO Doc 9997 Performance-Based Navigation (PBN) Operational Approval Manual.

Table 1: Overview of PBN specifications

FLIGHT PHASE								
	En-route		Arrival	Approach				Departure
	Oceanic	Continental		Initial	Intermediate	Final	Missed	
RNAV 10	10							
RNAV 5		5	5					
RNAV 2		2	2					2
RNAV 1		1	1	1	1		1	1
RNP 4	4							
RNP 2	2	2						
RNP 1			1	1	1		1	1
A-RNP	2	2 or 1	1–0.3	1–0.3	1–0.3	0.3	1–0.3	1–0.3
RNP APCH (LNAV)				1	1	0.3	1	
RNP APCH (LNAV/VNAV)				1	1	0.3	1	
RNP APCH (LP)				1	1		1	
RNP APCH (LPV)				1	1		1	
RNP AR APCH				1–0.1	1–0.1	0.3–0.1	1–0.1	
RNP 0.3 (H)		0.3	0.3	0.3	0.3		0.3	0.3

Numbers specify the accuracy level



no specific approval required



specific approval required

SPA.PBN.105 PBN operational approval

To obtain a PBN specific approval from the competent authority, the operator shall provide evidence that:

- (a) the relevant airworthiness approval, suitable for the intended PBN operation, is stated in the AFM or other document that has been approved by the certifying authority as part of an airworthiness assessment or is based on such approval;
- (b) a training programme for the flight crew members and relevant personnel involved in the flight preparation has been established;
- (c) a safety assessment has been carried out;
- (d) operating procedures have been established specifying:
 - (1) the equipment to be carried, including its operating limitations and appropriate entries in the minimum equipment list (MEL);
 - (2) flight crew composition, qualification and experience;
 - (3) normal, abnormal and contingency procedures; and
 - (4) electronic navigation data management;
- (e) a list of reportable events has been specified; and
- (f) a management RNP monitoring programme has been established for RNP AR APCH operations, if applicable.

AMC1 SPA.PBN.105(b) PBN operational approval

FLIGHT CREW TRAINING AND QUALIFICATIONS — GENERAL PROVISIONS

- (a) The operator should ensure that flight crew members training programmes for RNP AR APCH include structured courses of ground and FSTD training.
 - (1) Flight crew members with no RNP AR APCH experience should complete the full training programme prescribed in (b), (c), and (d) below.
 - (2) Flight crew members with RNP AR APCH experience with another EU operator may undertake an:
 - (i) abbreviated ground training course if operating a different type or class from that on which the previous RNP AR experience was gained;
 - (ii) abbreviated ground and FSTD training course if operating the same type or class and variant of the same type or class on which the previous RNP. AR experience was gained.
 - (iii) the abbreviated course should include at least the provisions of (d)(1), (c)(1) and (c)(2)(x) as appropriate.
 - (iv) The operator may reduce the number of approaches/landings required by (c)(2)(xii) if the type/class or the variant of the type or class has the same or similar:
 - (A) level of technology (flight guidance system (FGS));
 - (B) operating procedures for navigation performance monitoring; and
 - (C) handling characteristics

as the previously operated type or class.

- (3) Flight crew members with RNP AR APCH experience with the operator may undertake an abbreviated ground and FSTD training course:
- (i) when changing aircraft type or class, the abbreviated course should include at least the provisions of (d)(1), (c)(1), (c)(2);
 - (ii) when changing to a different variant of aircraft within the same type or class rating that has the same or similar of all of the following:
 - (A) level of technology (flight guidance system (FGS));
 - (B) operating procedures for navigation performance monitoring; and
 - (C) handling characteristicsas the previously operated type or class.
A difference course or familiarisation appropriate to the change of variant should fulfil the abbreviated course provisions.
 - (iii) when changing to a different variant of aircraft within the same type or class rating that has significantly different at least one of the following:
 - (A) level of technology (FGS);
 - (B) operating procedures for navigation performance monitoring; and
 - (C) handling characteristics,the provisions of (c)(1) and (c)(2) should be fulfilled.
- (4) The operator should ensure when undertaking RNP AR APCH operations with different variant(s) of aircraft within the same type or class rating, that the differences and/or similarities of the aircraft concerned justify such operations, taking into account at least the following:
- (i) the level of technology, including the:
 - (A) FGS and associated displays and controls;
 - (B) FMS and its integration or not with the FGS; and
 - (C) on-board performance monitoring and alerting (OBPMA) system;
 - (ii) operating procedures, including:
 - (A) navigation performance monitoring;
 - (B) approach interruption and missed approach including while in turn along an RF leg;
 - (C) abnormal procedures in case of loss of system redundancy affecting the guidance or the navigation; and
 - (D) abnormal and contingency procedures in case of total loss of RNP capability; and
 - (iii) handling characteristics, including:
 - (A) manual approach with RF leg;
 - (B) manual landing from automatic guided approach; and
 - (C) manual missed approach procedure from automatic approach.

(b) Ground training

- (1) Ground training for RNP AR APCH should address the following subjects during the initial introduction of a flight crew member to RNP AR APCH systems and operations. For recurrent programmes, the curriculum need only review initial curriculum items and address new, revised, or emphasised items.
- (2) General concepts of RNP AR APCH operation
 - (i) RNP AR APCH training should cover RNP AR APCH systems theory to the extent appropriate to ensure proper operational use. Flight crew members should understand basic concepts of RNP AR APCH systems, operation, classifications, and limitations.
 - (ii) The training should include general knowledge and operational application of RNP AR APCH instrument approach procedures. This training module should in particular address the following specific elements:
 - (A) the definitions of RNAV, RNP, RNP APCH, RNP AR APCH, RAIM, and containment areas;
 - (B) the differences between RNP AR APCH and RNP APCH;
 - (C) the types of RNP AR APCH procedures and familiarity with the charting of these procedures;
 - (D) the programming and display of RNP and aircraft specific displays, e.g. actual navigation performance;
 - (E) the methods to enable and disable the navigation updating modes related to RNP;
 - (F) the RNP values appropriate for different phases of flight and RNP AR APCH instrument procedures and how to select, if necessary;
 - (G) the use of GNSS RAIM (or equivalent) forecasts and the effects of RAIM 'holes' on RNP AR APCH procedures availability;
 - (H) when and how to terminate RNP navigation and transfer to conventional navigation due to loss of RNP and/or required equipment;
 - (I) the method to determine if the navigation database is current and contains required navigational data;
 - (J) the explanation of the different components that contribute to the total system error and their characteristics, e.g. drift characteristics when using IRU with no radio updating, QNH mistakes;
 - (K) the temperature compensation: Flight crew members operating avionics systems with compensation for altimetry errors introduced by deviations from ISA may disregard the temperature limits on RNP AR APCH procedures if flight crew training on use of the temperature compensation function is provided by the operator and the compensation function is utilised by the crew. However, the training should also recognise if the temperature compensation by the system is applicable to the VNAV guidance and is not a substitute for the flight crew compensating for the temperature effects on minimum altitudes or the DA/H;
 - (L) the effect of wind on aircraft performance during RNP AR APCH operations and the need to positively remain within RNP containment area, including any

- operational wind limitation and aircraft configuration essential to safely complete an RNP AR APCH operation;
- (M) the effect of groundspeed on compliance with RNP AR APCH procedures and bank angle restrictions that may impact on the ability to remain on the course centreline. For RNP procedures, aircraft are expected to maintain the standard speeds associated with the applicable category unless more stringent constraints are published;
 - (N) the relationship between RNP and the appropriate approach minima line on an approved published RNP AR APCH procedure and any operational limitations if the available RNP degrades or is not available prior to an approach (this should include flight crew operating procedures outside the FAF versus inside the FAF);
 - (O) understanding alerts that may occur from the loading and use of improper RNP values for a desired segment of an RNP AR APCH procedure;
 - (P) understanding the performance requirement to couple the autopilot/flight director to the navigation system's lateral guidance on RNP AR APCH procedures requiring an RNP of less than RNP 0.3;
 - (Q) the events that trigger a missed approach when using the aircraft's RNP capability to complete an RNP AR APCH procedure;
 - (R) any bank angle restrictions or limitations on RNP AR APCH procedures;
 - (S) ensuring flight crew members understand the performance issues associated with reversion to radio updating, know any limitations on the use of DME and VOR updating; and
 - (T) the familiarisation with the terrain and obstacles representations on navigation displays and approach charts.
- (3) ATC communication and coordination for use of RNP AR APCH
- (i) Ground training should instruct flight crew members on proper flight plan classifications and any ATC procedures applicable to RNP AR APCH operations.
 - (ii) Flight crew members should receive instruction on the need to advise ATC immediately when the performance of the aircraft's navigation system is no longer adequate to support continuation of an RNP AR APCH operation.
- (4) RNP AR APCH equipment components, controls, displays, and alerts
- (i) Theoretical training should include discussion of RNP terminology, symbology, operation, optional controls, and display features, including any items unique to an operator's implementation or systems. The training should address applicable failure alerts and limitations.
 - (ii) Flight crew members should achieve a thorough understanding of the equipment used in RNP operations and any limitations on the use of the equipment during those operations.
 - (iii) Flight crew members should also know what navigation sensors form the basis for their RNP AR APCH compliance, and they should be able to assess the impact of failure of any avionics or a known loss of ground systems on the remainder of the flight plan.
- (5) AFM information and operating procedures

- (i) Based on the AFM or other aircraft eligibility evidence, the flight crew should address normal and abnormal operating procedures, responses to failure alerts, and any limitations, including related information on RNP modes of operation.
 - (ii) Training should also address contingency procedures for loss or degradation of the RNP AR APCH capability.
 - (iii) The manuals used by the flight should contain this information.
- (6) MEL operating provisions
- (i) Flight crew members should have a thorough understanding of the MEL entries supporting RNP AR APCH operations.
- (c) Initial FSTD training
- (1) In addition to ground training, flight crew members should receive appropriate practical skill training in an FSTD.
- (i) Training programmes should cover the proper execution of RNP AR APCH operations in compliance with the manufacturer’s documentation.
 - (ii) The training should include:
 - (A) RNP AR APCH procedures and limitations;
 - (B) standardisation of the set-up of the cockpit’s electronic displays during an RNP AR APCH operation;
 - (C) recognition of the aural advisories, alerts and other annunciations that can impact on compliance with an RNP AR APCH procedure; and
 - (D) the timely and correct responses to loss of RNP AR APCH capability in a variety of scenarios embracing the breadth of the RNP AR APCH procedures the operator plans to complete.
- (2) FSTD training should address the following specific elements:
- (i) procedures for verifying that each flight crew member’s altimeter has the current setting before commencing the final approach of an RNP AR APCH operation, including any operational limitations associated with the source(s) for the altimeter setting and the latency of checking and setting the altimeters for landing;
 - (ii) use of aircraft RADAR, TAWS or other avionics systems to support the flight crew’s track monitoring and weather and obstacle avoidance;
 - (iii) concise and complete flight crew briefings for all RNP AR APCH procedures and the important role crew resource management (CRM) plays in successfully completing an RNP AR APCH operation;
 - (iv) the importance of aircraft configuration to ensure the aircraft maintains any mandated speeds during RNP AR APCH operations;
 - (v) the potentially detrimental effect of reducing the flap setting, reducing the bank angle or increasing airspeeds may have on the ability to comply with an RNP AR APCH operation;
 - (vi) flight crew members understand and are capable of programming and/or operating the FMC, autopilot, autothrottles, RADAR, GNSS, INS, EFIS (including the moving map), and TAWS in support of RNP AR APCH operations;
 - (vii) handling of TOGA to LNAV transition as applicable, particularly while in turn;

- (viii) monitoring of flight technical error (FTE) and related go-around operation;
- (ix) handling of loss of GNSS signals during a procedure;
- (x) handling of engine failure during the approach operation;
- (xi) applying contingency procedures for a loss of RNP capability during a missed approach. Due to the lack of navigation guidance, the training should emphasise the flight crew contingency actions that achieve separation from terrain and obstacles. The operator should tailor these contingency procedures to their specific RNP AR APCH procedures; and
- (xii) as a minimum, each flight crew member should complete two RNP approach procedures for each duty position (pilot flying and pilot monitoring) that employ the unique RNP AR APCH characteristics of the operator's RNP AR APCH procedures (e.g. RF legs, missed approach). One procedure should culminate in a transition to landing and one procedure should culminate in execution of an RNP missed approach procedure.

FLIGHT CREW TRAINING AND QUALIFICATIONS — CONVERSION TRAINING

- (d) Flight crew members should complete the following RNP AR APCH training if converting to a new type or class or variant of aircraft in which RNP AR operations will be conducted. For abbreviated courses, the provisions prescribed in (a)(2), (a)(3) and (a)(4) should apply.

(1) Ground training

Taking into account the flight crew member's RNP AR APCH previous training and experience, flight crew members should undertake an abbreviated ground training that should include at least the provisions of (b)(2)(D) to (I), (b)((2)(N) to (R), (b)(2)(S), and (b)(3) to (6).

(2) FSTD training

The provisions prescribed in (a) should apply, taking into account the flight crew member's RNP AR APCH training and experience.

FLIGHT CREW TRAINING AND QUALIFICATIONS — RNP AR APCH PROCEDURES REQUIRING A PROCEDURE-SPECIFIC APPROVAL

- (e) Before starting an RNP AR APCH procedure for which a procedure-specific approval is required, flight crew members should undertake additional ground training and FSTD training, as appropriate.

(1) The operator should ensure that the additional training programmes for such procedures include as at least all of the following:

- (i) the provisions of (c)(1), (c)(2)(x) as appropriate and customised to the intended operation;
- (ii) the crew training recommendations and mitigations stated in the procedure flight operational safety assessment (FOSA); and
- (iii) specific training and operational provision published in the AIP, where applicable.

(2) Flight crew members with prior experience of RNP AR APCH procedures for which a procedure-specific approval is required may receive credit for all or part of these provisions provided the current operator's RNP AR APCH procedures are similar and require no new pilot skills to be trained in an FSTD.

- (3) Training and checking may be combined and conducted by the same person with regard to (f)(2).
- (4) In case of a first RNP AR APCH application targeting directly RNP AR APCH procedures requiring procedure-specific approvals, a combined initial and additional training and checking, as appropriate, should be acceptable provided the training and checking includes all provisions prescribed by (a), (b), (c), (d) as appropriate, (e) and (f).

FLIGHT CREW TRAINING AND QUALIFICATIONS — CHECKING OF RNP AR APCH KNOWLEDGE

(f) Initial checking of RNP AR APCH knowledge and procedures

- (1) The operator should check flight crew members' knowledge of RNP AR APCH procedures prior to employing RNP AR APCH operations. As a minimum, the check should include a thorough review of flight crew procedures and specific aircraft performance requirements for RNP AR APCH operations.
- (2) The initial check should include one of the following:
 - (i) A check by an examiner using an FSTD.
 - (ii) A check by a TRE, CRE, SFE or a commander nominated by the operator during LPCs, OPCs or line flights that incorporate RNP AR APCH operations that employ the unique RNP AR APCH characteristics of the operator's RNP AR APCH procedures.
 - (iii) Line-oriented flight training (LOFT)/line-oriented evaluation (LOE). LOFT/LOE programmes using an FSTD that incorporates RNP AR APCH operations that employ the unique RNP AR APCH characteristics (i.e. RF legs, RNP missed approach) of the operator's RNP AR APCH procedures.
- (3) Specific elements that should be addressed are:
 - (i) demonstration of the use of any RNP AR APCH limits/minimums that may impact various RNP AR APCH operations;
 - (ii) demonstration of the application of radio-updating procedures, such as enabling and disabling ground-based radio updating of the FMC (e.g. DME/DME and VOR/DME updating) and knowledge of when to use this feature;
 - (iii) demonstration of the ability to monitor the actual lateral and vertical flight paths relative to programmed flight path and complete the appropriate flight crew procedures when exceeding a lateral or vertical FTE limit;
 - (iv) demonstration of the ability to read and adapt to a RAIM (or equivalent) forecast, including forecasts predicting a lack of RAIM availability;
 - (v) demonstration of the proper set-up of the FMC, the weather RADAR, TAWS, and moving map for the various RNP AR APCH operations and scenarios the operator plans to implement;
 - (vi) demonstration of the use of flight crew briefings and checklists for RNP AR APCH operations with emphasis on CRM;
 - (vii) demonstration of knowledge of and ability to perform an RNP AR APCH missed approach procedure in a variety of operational scenarios (i.e. loss of navigation or failure to acquire visual conditions);
 - (viii) demonstration of speed control during segments requiring speed restrictions to ensure compliance with an RNP AR APCH procedure;

- (ix) demonstration of competent use of RNP AR APCH plates, briefing cards, and checklists;
- (x) demonstration of the ability to complete a stable RNP AR APCH operation: bank angle, speed control, and remaining on the procedure's centreline; and
- (xi) knowledge of the operational limit for deviation from the desired flight path and of how to accurately monitor the aircraft's position relative to vertical flight path.

FLIGHT CREW TRAINING AND QUALIFICATIONS — RECURRENT TRAINING

- (g) The operator should incorporate recurrent training that employs the unique RNP AR APCH characteristics of the operator's RNP AR APCH procedures as part of the overall training programme.
 - (1) A minimum of two RNP AR APCH should be flown by each flight crew member, one for each duty position (pilot flying and pilot monitoring), with one culminating in a landing and one culminating in a missed approach, and may be substituted for any required 3D approach operation.
 - (2) In case of several procedure-specific RNP AR APCH approvals, the recurrent training should focus on the most demanding RNP AR APCH procedures giving credit on the less demanding ones.

TRAINING FOR PERSONNEL INVOLVED IN THE FLIGHT PREPARATION

- (h) The operator should ensure that training for flight operation officers/dispatchers should include:
 - (1) the different types of RNP AR APCH procedures;
 - (2) the importance of specific navigation equipment and other equipment during RNP AR APCH operations and related RNP AR APCH requirements and operating procedures;
 - (3) the operator's RNP AR APCH approvals;
 - (4) MEL requirements;
 - (5) aircraft performance, and navigation signal availability, e.g. GNSS RAIM/predictive RNP capability tool, for destination and alternate aerodromes.

AMC1 SPA.PBN.105(c) PBN operational approval

FLIGHT OPERATIONAL SAFETY ASSESSMENT (FOSA)

- (a) For each RNP AR APCH procedure, the operator should conduct a flight operational safety assessment (FOSA) proportionate to the complexity of the procedure.
- (b) The FOSA should be based on:
 - (1) restrictions and recommendations published in AIPs;
 - (2) the flyability check;
 - (3) an assessment of the operational environment;
 - (4) the demonstrated navigation performance of the aircraft; and
 - (5) the operational aircraft performance.
- (c) The operator may take credit from key elements from the safety assessment carried out by the ANSP or the aerodrome operator.

GM1 SPA.PBN.105(c) PBN operational approval

FLIGHT OPERATIONAL SAFETY ASSESSMENT (FOSA)

- (a) Traditionally, operational safety has been defined by a target level of safety (TLS) and specified as a risk of collision of 10^{-7} per approach operation. For RNP AR APCH operations, conducting the FOSA methodology contributes to achieving the TLS. The FOSA is intended to provide a level of flight safety that is equivalent to the traditional TLS, but using methodology oriented to performance-based flight operations. Using the FOSA, the operational safety objective is met by considering more than the aircraft navigation system alone. The FOSA blends quantitative and qualitative analyses and assessments by considering navigation systems, aircraft performance, operating procedures, human factor aspects and the operational environment. During these assessments conducted under normal and failure conditions, hazards, risks and the associated mitigations are identified. The FOSA relies on the detailed criteria for the aircraft capabilities and instrument procedure design to address the majority of general technical, procedure and process factors. Additionally, technical and operational expertise and prior operator experience with RNP AR APCH operations are essential elements to be considered in the conduct and conclusion of the FOSA.
- (b) The following aspects need to be considered during FOSA, in order to identify hazards, risks and mitigations relevant to RNP AR APCH operations:
- (1) Normal performance: lateral and vertical accuracy are addressed in the aircraft airworthiness standards, aircraft and systems operate normally in standard configurations and operating modes, and individual error components are monitored/truncated through system design or flight crew procedure.
 - (2) Performance under failure conditions: lateral and vertical accuracy are evaluated for aircraft failures as part of the aircraft certification. Additionally, other rare-normal and abnormal failures and conditions for ATC operations, flight crew procedures, infrastructure and operating environment are assessed. Where the failure or condition results are not acceptable for continued operation, mitigations are developed or limitations established for the aircraft, flight crew and/or operation.
 - (3) Aircraft failures
 - (i) System failure: Failure of a navigation system, flight guidance system, flight instrument system for the approach, or missed approach (e.g. loss of GNSS updating, receiver failure, autopilot disconnect, FMS failure, etc.). Depending on the aircraft, this may be addressed through aircraft design or operating procedure to cross-check guidance (e.g. dual equipage for lateral errors, use of terrain awareness and warning system).
 - (ii) Malfunction of air data system or altimetry: flight crew procedure cross-check between two independent systems may mitigate this risk.
 - (4) Aircraft performance
 - (i) Inadequate performance to conduct the approach operation: the aircraft capabilities and operating procedures ensure that the performance is adequate on each approach, as part of flight planning and in order to begin or continue the approach. Consideration should be given to aircraft configuration during approach and any configuration changes associated with a missed approach operation (e.g. engine failure, flap retraction, re-engagement of autopilot in LNAV mode).
 - (ii) Loss of engine: loss of an engine while on an RNP AR APCH operation is a rare occurrence due to high engine reliability and the short exposure time. The operator

needs to take appropriate action to mitigate the effects of loss of engine, initiating a go-around and manually taking control of the aircraft if necessary.

- (5) Navigation services
 - (i) Use of a navigation aid outside of designated coverage or in test mode: aircraft airworthiness standards and operating procedures have been developed to address this risk.
 - (ii) Navigation database errors: instrument approach procedures are validated through flight validation specific to the operator and aircraft, and the operator should have a process defined to maintain validated data through updates to the navigation database.
- (6) ATC operations
 - (i) Procedure assigned to non-approved aircraft: flight crew are responsible for rejecting the clearance.
 - (ii) ATC provides 'direct to' clearance to or vectors aircraft onto approach such that performance cannot be achieved.
 - (iii) Inconsistent ATC phraseology between controller and flight crew.
- (7) Flight crew operations
 - (i) Erroneous barometric altimeter setting: flight crew entry and cross-check procedures may mitigate this risk.
 - (ii) Incorrect procedure selection or loading: flight crew procedures should be available to verify that the loaded procedure matches the published procedure, line of minima and aircraft airworthiness qualification.
 - (iii) Incorrect flight control mode selected: training on importance of flight control mode, flight crew procedure to verify selection of correct flight control mode.
 - (iv) Incorrect RNP entry: flight crew procedure to verify RNP loaded in system matches the published value.
 - (v) Missed approach: balked landing or rejected landing at or below DA/H.
 - (vi) Poor meteorological conditions: loss or significant reduction of visual reference that may result in a go-around.
- (8) Infrastructure
 - (i) GNSS satellite failure: this condition is evaluated during aircraft qualification to ensure obstacle clearance can be maintained, considering the low likelihood of this failure occurring.
 - (ii) Loss of GNSS signals: relevant independent equipment, e.g. IRS/INS, is mandated for RNP AR APCH procedures with RF legs and approaches where the accuracy for the missed approach is less than 1 NM. For other approaches, operating procedures are used to approximate the published track and climb above obstacles.
 - (iii) Testing of ground navigation aids in the vicinity of the approach: aircraft and operating procedures should detect and mitigate this event.
- (9) Operating conditions
 - (i) Tailwind conditions: excessive speed on RF legs may result in inability to maintain track. This is addressed through aircraft airworthiness standards on the limits of

command guidance, inclusion of 5 degrees of bank manoeuvrability margin, consideration of speed effect and flight crew procedure to maintain speeds below the maximum authorised for the RNP AR APCH procedure.

- (ii) Wind conditions and effect on FTE: nominal FTE is evaluated under a variety of wind conditions, and flight crew procedures to monitor and limit deviations to ensure safe operation.
- (iii) Extreme temperature effects of barometric altitude (e.g. extreme cold temperatures, known local atmospheric or weather phenomena, high winds, severe turbulence, etc.): the effect of this error on the vertical path is mitigated through the procedure design and flight crew procedures, with an allowance for aircraft that compensate for this effect to conduct procedures regardless of the published temperature limit. The effect of this error on minimum segment altitudes and the DA/H are addressed in an equivalent manner to all other approach operations.

AMC1 SPA.PBN.105(d) PBN operational approval

OPERATIONAL CONSIDERATIONS FOR RNP AR APCH

- (a) MEL
 - (1) The operator's MEL should be developed/revised to address the equipment provisions for RNP AR APCH operations.
 - (2) An operational TAWS Class A should be available for all RNP AR APCH operations. The TAWS should use altitude values that are compensated for local pressure and temperature effects (e.g. corrected barometric and GNSS altitude), and include significant terrain and obstacle data.
- (b) Autopilot and flight director
 - (1) For RNP AR APCH operations with RNP values less than RNP 0.3 or with RF legs, the autopilot or flight director driven by the area navigation system should be used. Thus, the flight crew should check that the autopilot/flight director is installed and operational.
- (c) Preflight RNP assessment
 - (1) The operator should have a predictive performance capability, which can determine if the specified RNP will be available at the time and location of a desired RNP operation. This capability can be a ground service and need not be resident in the aircraft's avionics equipment. The operator should establish procedures requiring use of this capability as both a preflight preparation tool and as a flight-following tool in the event of reported failures.
 - (2) This predictive capability should account for known and predicted outages of GNSS satellites or other impacts on the navigation system's sensors. The prediction programme should not use a mask angle below 5 degrees, as operational experience indicates that satellite signals at low elevations are not reliable. The prediction should use the actual GNSS constellation with the RAIM (or equivalent) algorithm identical to or more conservative than that used in the actual equipment.
 - (3) The RNP assessment should consider the specific combination of the aircraft capability (sensors and integration), as well as their availability.
- (d) NAVAID exclusion

- (1) The operator should establish procedures to exclude NAVAID facilities in accordance with NOTAMs (e.g. DMEs, VORs, localisers). Internal avionics reasonableness checks may not be adequate for RNP operations.
- (e) Navigation database currency
 - (1) During system initialisation, the flight crew should confirm that the navigation database is current. Navigation databases should be current for the duration of the flight. If the AIRAC cycle is due to change during flight, the flight crew should follow procedures established by the operator to ensure the accuracy of navigation data.
 - (2) The operator should not allow the flight crew to use an expired database.

AMC2 SPA.PBN.105(d) PBN operational approval

FLIGHT CONSIDERATIONS

(a) Modification of flight plan

The flight crew should not be authorised to fly a published RNP AR APCH procedure unless it is retrievable by the procedure name from the aircraft navigation database and conforms to the charted procedure. The lateral path should not be modified; with the exception of accepting a clearance to go direct to a fix in the approach procedure that is before the FAF and that does not immediately precede an RF leg. The only other acceptable modification to the loaded procedure is to change altitude and/or airspeed waypoint constraints on the initial, intermediate, or missed approach segments flight plan fixes (e.g. to apply temperature corrections or comply with an ATC clearance/instruction).

(b) Mandatory equipment

The flight crew should have either a mandatory list of equipment for conducting RNP AR APCH operations or alternate methods to address in-flight equipment failures that would prohibit RNP AR APCH operations (e.g. crew warning systems, quick reference handbook).

(c) RNP management

Operating procedures should ensure that the navigation system uses the appropriate RNP values throughout the approach operation. If the navigation system does not extract and set the navigation accuracy from the on-board navigation database for each segment of the procedure, then operating procedures should ensure that the smallest navigation accuracy required to complete the approach or the missed approach is selected before initiating the approach operation (e.g. before the IAF). Different IAFs may have different navigation accuracy, which are annotated on the approach chart.

(d) Loss of RNP

The flight crew should ensure that no loss of RNP annunciation is received prior to commencing the RNP AR APCH operation. During the approach operation, if at any time a loss of RNP annunciation is received, the flight crew should abandon the RNP AR APCH operation unless the pilot has in sight the visual references required to continue the approach operation.

(e) Radio updating

Initiation of all RNP AR APCH procedures is based on GNSS updating. The flight crew should comply with the operator's procedures for inhibiting specific facilities.

(f) Approach procedure confirmation

The flight crew should confirm that the correct procedure has been selected. This process includes confirmation of the waypoint sequence, reasonableness of track angles and distances, and any other parameters that can be altered by the flight crew, such as altitude or speed constraints. A navigation system textual display or navigation map display should be used.

(g) Track deviation monitoring

- (1) The flight crew should use a lateral deviation indicator, flight director and/or autopilot in lateral navigation mode on RNP AR APCH operations. The flight crew of an aircraft with a lateral deviation indicator should ensure that lateral deviation indicator scaling (full-scale deflection) is suitable for the navigation accuracy associated with the various segments of the RNP AR APCH procedure. The flight crew is expected to maintain procedure centrelines, as depicted by on-board lateral deviation indicators and/or flight guidance during the entire RNP AR APCH operations unless authorised to deviate by ATC or demanded under emergency conditions. For normal operations, cross-track error/deviation (the difference between the area-navigation-system-computed path and the aircraft position relative to the path) should be limited to the navigation accuracy (RNP) associated with the procedure segment.
- (2) Vertical deviation should be monitored above and below the glide-path; the vertical deviation should be within ± 75 ft of the glide-path during the final approach segment.
- (3) Flight crew should execute a missed approach operation if:
 - (i) the lateral deviation exceeds one time the RNP value; or
 - (ii) the deviation below the vertical path exceeds 75 ft or half-scale deflection where angular deviation is indicated, at any time; or
 - (iii) the deviation above the vertical path exceeds 75 ft or half-scale deflection where angular deviation is indicated; at or below 1 000 ft above aerodrome level;unless the pilot has in sight the visual references required to continue the approach operation.
- (4) Where a moving map, low-resolution vertical deviation indicator (VDI), or numeric display of deviations are to be used, flight crew training and procedures should ensure the effectiveness of these displays. Typically, this involves demonstration of the procedure with a number of trained flight crew members and inclusion of this monitoring procedure in the recurrent RNP AR APCH training programme.
- (5) For installations that use a CDI for lateral path tracking, the AFM should state which navigation accuracy and operations the aircraft supports and the operational effects on the CDI scale. The flight crew should know the CDI full-scale deflection value. The avionics may automatically set the CDI scale (dependent on phase of flight) or the flight crew may manually set the scale. If the flight crew manually selects the CDI scale, the operator should have procedures and training in place to assure the selected CDI scale is appropriate for the intended RNP operation. The deviation limit should be readily apparent given the scale (e.g. full-scale deflection).

(h) System cross-check

- (1) The flight crew should ensure the lateral and vertical guidance provided by the navigation system is consistent.

(i) Procedures with RF legs

- (1) When initiating a missed approach operation during or shortly after the RF leg, the flight crew should be aware of the importance of maintaining the published path as closely as

possible. Operating procedures should be provided for aircraft that do not stay in LNAV when a missed approach is initiated to ensure the RNP AR APCH ground track is maintained.

- (2) The flight crew should not exceed the maximum airspeed values shown in Table 1 throughout the RF leg. For example, a Category C A320 should slow to 160 KIAS at the FAF or may fly as fast as 185 KIAS if using Category D minima. A missed approach operation prior to DA/H may require compliance with speed limitation for that segment.

Table 1: Maximum airspeed by segment and category

Indicated airspeed (Knots)					
Segment	Indicated airspeed by aircraft category				
	Cat A	Cat B	Cat C	Cat D	Cat E
Initial & intermediate (IAF to FAF)	150	180	240	250	250
Final (FAF to DA)	100	130	160	185	as specified
Missed approach (DA/H to MAHP)	110	150	240	265	as specified
Airspeed restriction*	as specified				

*Airspeed restrictions may be used to reduce turn radius regardless of aircraft category.

- (j) Temperature compensation

For aircraft with temperature compensation capabilities, the flight crew may disregard the temperature limits on RNP procedures if the operator provides pilot training on the use of the temperature compensation function. It should be noted that a temperature compensation by the system is applicable to the VNAV guidance and is not a substitute for the flight crew compensating for temperature effects on minimum altitudes or DA/H. The flight crew should be familiar with the effects of the temperature compensation on intercepting the compensated path as described in EUROCAE ED-75C/RTCA DO-236C Appendix H.

- (k) Altimeter setting

Due to the performance-based obstruction clearance inherent in RNP instrument procedures, the flight crew should verify that the most current aerodrome altimeter is set prior to the FAF. The operator should take precautions to switch altimeter settings at appropriate times or locations and request a current altimeter setting if the reported setting may not be recent, particularly at times when pressure is reported or expected to be rapidly decreasing. Execution of an RNP operation necessitates the current altimeter setting for the aerodrome of intended landing. Remote altimeter settings should not be allowed.

- (l) Altimeter cross-check

- (1) The flight crew should complete an altimetry cross-check ensuring both pilots' altimeters agree within ± 100 ft prior to the FAF but no earlier than when the altimeters are set for the aerodrome of intended landing. If the altimetry cross-check fails, then the approach operation should not be continued.
- (2) This operational cross-check should not be necessary if the aircraft systems automatically compare the altitudes to within 75 ft.

- (m) Missed approach operation

Where possible, the missed approach operation should necessitate RNP 1.0. The missed approach portion of these procedures should be similar to a missed approach of an RNP APCH procedure.

Where necessary, navigation accuracy less than RNP 1.0 may be used in the missed approach segment.

- (1) In many aircraft, executing a missed approach activating take-off/go-around (TOGA) may cause a change in lateral navigation. In many aircraft, activating TOGA disengages the autopilot and flight director from LNAV guidance, and the flight director reverts to track-hold derived from the inertial system. LNAV guidance to the autopilot and flight director should be re-engaged as quickly as possible.
 - (2) Flight crew procedures and training should address the impact on navigation capability and flight guidance if the pilot initiates a missed approach while the aircraft is in a turn. When initiating an early missed approach operation, the flight crew should follow the rest of the approach track and missed approach track unless a different clearance has been issued by ATC. The flight crew should also be aware that RF legs are designed based on the maximum true airspeed at normal altitudes, and initiating an early missed approach operation will reduce the manoeuvrability margin and potentially even make holding the turn impractical at missed approach speeds.
- (n) Contingency procedures
- (1) Failure while en route
The flight crew should be able to assess the impact of GNSS equipment failure on the anticipated RNP AR APCH operation and take appropriate action.
 - (2) Failure on approach
The operator's contingency procedures should address at least the following conditions:
 - (i) failure of the area navigation system components, including those affecting lateral and vertical deviation performance (e.g. failures of a GPS sensor, the flight director or autopilot);
 - (ii) loss of navigation signal-in-space (loss or degradation of external signal).

AMC3 SPA.PBN.105(d) PBN operational approval

NAVIGATION DATABASE MANAGEMENT

- (a) The operator should validate every RNP AR APCH procedure before using the procedure in instrument meteorological conditions (IMC) to ensure compatibility with their aircraft and to ensure the resulting path matches the published procedure. As a minimum, the operator should:
 - (1) compare the navigation data for the procedure(s) to be loaded into the FMS with the published procedure.
 - (2) validate the loaded navigation data for the procedure, either in an FSTD or in the actual aircraft in VMC. The depicted procedure on the map display should be compared to the published procedure. The entire procedure should be flown to ensure the path is flyable, does not have any apparent lateral or vertical path disconnects and is consistent with the published procedure.
 - (3) Once the procedure is validated, a copy of the validated navigation data should be retained for comparison with subsequent data updates.

- (4) For published procedures, where FOSA demonstrated that the procedure is not in a challenging operational environment, the flight or FSTD validation may be credited from already validated equivalent RNP AR APCH procedures.
- (b) If an aircraft system required for RNP AR APCH operations is modified, the operator should assess the need for a validation of the RNP AR APCH procedures with the navigation database and the modified system. This may be accomplished without any direct evaluation if the manufacturer verifies that the modification has no effect on the navigation database or path computation. If no such assurance from the manufacturer is available, the operator should conduct initial data validation with the modified system.
- (c) The operator should implement procedures that ensure timely distribution and insertion of current and unaltered electronic navigation data to all aircraft that require it.

AMC1 SPA.PBN.105(e) PBN operational approval

REPORTABLE EVENTS

The operator should report events which are listed in AMC2 ORO.GEN.160.

AMC1 SPA.PBN.105(f) PBN operational approval

RNP MONITORING PROGRAMME

- (a) The operator approved to conduct RNP AR APCH operations, should have an RNP monitoring programme to ensure continued compliance with applicable rules and to identify any negative trends in performance.
- (b) During an interim approval period, which should be at least 90 days, the operator should at least submit the following information every 30 days to the competent authority.
 - (1) Total number of RNP AR APCH operations conducted;
 - (2) Number of approach operations by aircraft/system which were completed as planned without any navigation or guidance system anomalies;
 - (3) Reasons for unsatisfactory approaches, such as:
 - (i) UNABLE REQ NAV PERF, NAV ACCUR DOWNGRAD, or other RNP messages during approaches;
 - (ii) excessive lateral or vertical deviation;
 - (iii) TAWS warning;
 - (iv) autopilot system disconnect;
 - (v) navigation data errors; or
 - (vi) flight crew reports of any anomaly;
 - (4) Flight crew comments.
- (c) Thereafter, the operator should continue to collect and periodically review this data to identify potential safety concerns, and maintain summaries of this data.

SUBPART C: OPERATIONS WITH SPECIFIED MINIMUM NAVIGATION PERFORMANCE (MNPS)

SPA.MNPS.100 MNPS operations

Aircraft shall only be operated in designated minimum navigation performance specifications (MNPS) airspace in accordance with regional supplementary procedures, where minimum navigation performance specifications are established, if the operator has been granted an approval by the competent authority to conduct such operations.

GM1 SPA.MNPS.100 MNPS operations

DOCUMENTATION

MNPS and the procedures governing their application are published in the Regional Supplementary Procedures, ICAO Doc 7030, as well as in national AIPs.

SPA.MNPS.105 MNPS operational approval

To obtain an MNPS operational approval from the competent authority, the operator shall provide evidence that:

- (a) the navigation equipment meets the required performance;
- (b) navigation displays, indicators and controls are visible and operable by either pilot seated at his/her duty station;
- (c) a training programme for the flight crew members involved in these operations has been established;
- (d) operating procedures have been established specifying:
 - (1) the equipment to be carried, including its operating limitations and appropriate entries in the MEL;
 - (2) flight crew composition and experience requirements;
 - (3) normal procedures;
 - (4) contingency procedures including those specified by the authority responsible for the airspace concerned;
 - (5) monitoring and incident reporting.

AMC1 SPA.MNPS.105 MNPS operational approval

LONG RANGE NAVIGATION SYSTEM (LRNS)

- (a) For unrestricted operation in MNPS airspace an aircraft should be equipped with two independent LRNSs.
- (b) An LRNS may be one of the following:
 - (1) one inertial navigation system (INS);
 - (2) one global navigation satellite system (GNSS); or
 - (3) one navigation system using the inputs from one or more inertial reference system (IRS) or any other sensor system complying with the MNPS requirement.
- (c) In case of the GNSS is used as a stand-alone system for LRNS, an integrity check should be carried out.
- (d) For operation in MNPS airspace along notified special routes the aeroplane should be equipped with one LRNS.

SUBPART D: OPERATIONS IN AIRSPACE WITH REDUCED VERTICAL SEPARATION MINIMA (RVSM)

SPA.RVSM.100 RVSM operations

Aircraft shall only be operated in designated airspace where a reduced vertical separation minimum of 300 m (1000 ft) applies between flight level (FL) 290 and FL 410, inclusive, if the operator has been granted an approval by the competent authority to conduct such operations.

SPA.RVSM.105 RVSM operational approval

To obtain an RVSM operational approval from the competent authority, the operator shall provide evidence that:

- (a) the RVSM airworthiness approval has been obtained;
- (b) procedures for monitoring and reporting height-keeping errors have been established;
- (c) a training programme for the flight crew members involved in these operations has been established;
- (d) operating procedures have been established specifying:
 - (1) the equipment to be carried, including its operating limitations and appropriate entries in the MEL;
 - (2) flight crew composition and experience requirements;
 - (3) flight planning;
 - (4) pre-flight procedures;
 - (5) procedures prior to RVSM airspace entry;
 - (6) in-flight procedures;
 - (7) post-flight procedures;
 - (8) incident reporting;
 - (9) specific regional operating procedures.

AMC1 SPA.RVSM.105 RVSM operational approval

CONTENT OF OPERATOR RVSM APPLICATION

The following material should be made available to the competent authority, in sufficient time to permit evaluation, before the intended start of RVSM operations:

- (a) **Airworthiness documents**
Documentation that shows that the aircraft has RVSM airworthiness approval. This should include an aircraft flight manual (AFM) amendment or supplement.
- (b) **Description of aircraft equipment**
A description of the aircraft appropriate to operations in an RVSM environment.

(c) Training programmes, operating practices and procedures

The operator should submit training syllabi for initial and recurrent training programmes together with other relevant material. The material should show that the operating practices, procedures and training items, related to RVSM operations in airspace that requires State operational approval, are incorporated.

(d) Manuals and checklists

The appropriate manuals and checklists should be revised to include information/guidance on standard operating procedures. Manuals should contain a statement of the airspeeds, altitudes and weights considered in RVSM aircraft approval, including identification of any operating limitations or conditions established for that aircraft type. Manuals and checklists may need to be submitted for review by the competent authority as part of the application process.

(e) Past performance

Relevant operating history, where available, should be included in the application. The applicant should show that any required changes have been made in training, operating or maintenance practices to improve poor height-keeping performance.

(f) Minimum equipment list

Where applicable, a minimum equipment list (MEL), adapted from the master minimum equipment list (MMEL), should include items pertinent to operating in RVSM airspace.

(g) Plan for participation in verification/monitoring programmes

The operator should establish a plan for participation in any applicable verification/monitoring programme acceptable to the competent authority. This plan should include, as a minimum, a check on a sample of the operator's fleet by a regional monitoring agency (RMA)'s independent height-monitoring system.

AMC2 SPA.RVSM.105 RVSM operational approval

OPERATING PROCEDURES

(a) Flight planning

(1) During flight planning the flight crew should pay particular attention to conditions that may affect operation in RVSM airspace. These include, but may not be limited to:

- (i) verifying that the airframe is approved for RVSM operations;
- (ii) reported and forecast weather on the route of flight;
- (iii) minimum equipment requirements pertaining to height-keeping and alerting systems; and
- (iv) any airframe or operating restriction related to RVSM operations.

(b) Pre-flight procedures

(1) The following actions should be accomplished during the pre-flight procedure:

- (i) Review technical logs and forms to determine the condition of equipment required for flight in the RVSM airspace. Ensure that maintenance action has been taken to correct defects to required equipment.

- (ii) During the external inspection of aircraft, particular attention should be paid to the condition of static sources and the condition of the fuselage skin near each static source and any other component that affects altimetry system accuracy. This check may be accomplished by a qualified and authorised person other than the pilot (e.g. a flight engineer or ground engineer).
 - (iii) Before take-off, the aircraft altimeters should be set to the QNH (atmospheric pressure at nautical height) of the airfield and should display a known altitude, within the limits specified in the aircraft operating manuals. The two primary altimeters should also agree within limits specified by the aircraft operating manual. An alternative procedure using QFE (atmospheric pressure at aerodrome elevation/runway threshold) may also be used. The maximum value of acceptable altimeter differences for these checks should not exceed 23 m (75 ft). Any required functioning checks of altitude indicating systems should be performed.
 - (iv) Before take-off, equipment required for flight in RVSM airspace should be operative and any indications of malfunction should be resolved.
- (c) Prior to RVSM airspace entry
- (1) The following equipment should be operating normally at entry into RVSM airspace:
 - (i) two primary altitude measurement systems. A cross-check between the primary altimeters should be made. A minimum of two will need to agree within ± 60 m (± 200 ft). Failure to meet this condition will require that the altimetry system be reported as defective and air traffic control (ATC) notified;
 - (ii) one automatic altitude-control system;
 - (iii) one altitude-alerting device; and
 - (iv) operating transponder.
 - (2) Should any of the required equipment fail prior to the aircraft entering RVSM airspace, the pilot should request a new clearance to avoid entering this airspace.
- (d) In-flight procedures
- (1) The following practices should be incorporated into flight crew training and procedures:
 - (i) Flight crew should comply with any aircraft operating restrictions, if required for the specific aircraft type, e.g. limits on indicated Mach number, given in the RVSM airworthiness approval.
 - (ii) Emphasis should be placed on promptly setting the sub-scale on all primary and standby altimeters to 1013.2 hPa / 29.92 in Hg when passing the transition altitude, and rechecking for proper altimeter setting when reaching the initial cleared flight level.
 - (iii) In level cruise it is essential that the aircraft is flown at the cleared flight level. This requires that particular care is taken to ensure that ATC clearances are fully understood and followed. The aircraft should not intentionally depart from cleared flight level without a positive clearance from ATC unless the crew are conducting contingency or emergency manoeuvres.
 - (iv) When changing levels, the aircraft should not be allowed to overshoot or undershoot the cleared flight level by more than 45 m (150 ft). If installed, the level off should be

- accomplished using the altitude capture feature of the automatic altitude-control system.
- (v) An automatic altitude-control system should be operative and engaged during level cruise, except when circumstances such as the need to re-trim the aircraft or turbulence require disengagement. In any event, adherence to cruise altitude should be done by reference to one of the two primary altimeters. Following loss of the automatic height-keeping function, any consequential restrictions will need to be observed.
 - (vi) Ensure that the altitude-alerting system is operative.
 - (vii) At intervals of approximately 1 hour, cross-checks between the primary altimeters should be made. A minimum of two will need to agree within ± 60 m (± 200 ft). Failure to meet this condition will require that the altimetry system be reported as defective and ATC notified or contingency procedures applied:
 - (A) the usual scan of flight deck instruments should suffice for altimeter cross-checking on most flights; and
 - (B) before entering RVSM airspace, the initial altimeter cross-check of primary and standby altimeters should be recorded.
 - (viii) In normal operations, the altimetry system being used to control the aircraft should be selected for the input to the altitude reporting transponder transmitting information to ATC.
 - (ix) If the pilot is notified by ATC of a deviation from an assigned altitude exceeding ± 90 m (± 300 ft) then the pilot should take action to return to cleared flight level as quickly as possible.
- (2) Contingency procedures after entering RVSM airspace are as follows:
- (i) The pilot should notify ATC of contingencies (equipment failures, weather) that affect the ability to maintain the cleared flight level and coordinate a plan of action appropriate to the airspace concerned. The pilot should obtain the guidance on contingency procedures is contained in the relevant publications dealing with the airspace.
 - (ii) Examples of equipment failures that should be notified to ATC are:
 - (A) failure of all automatic altitude-control systems aboard the aircraft;
 - (B) loss of redundancy of altimetry systems;
 - (C) loss of thrust on an engine necessitating descent; or
 - (D) any other equipment failure affecting the ability to maintain cleared flight level.
 - (iii) The pilot should notify ATC when encountering greater than moderate turbulence.
 - (iv) If unable to notify ATC and obtain an ATC clearance prior to deviating from the cleared flight level, the pilot should follow any established contingency procedures for the region of operation and obtain ATC clearance as soon as possible.
- (e) Post-flight procedures
- (1) In making technical log entries against malfunctions in height-keeping systems, the pilot should provide sufficient detail to enable maintenance to effectively troubleshoot and

repair the system. The pilot should detail the actual defect and the crew action taken to try to isolate and rectify the fault.

- (2) The following information should be recorded when appropriate:
 - (i) primary and standby altimeter readings;
 - (ii) altitude selector setting;
 - (iii) subscale setting on altimeter;
 - (iv) autopilot used to control the aircraft and any differences when an alternative autopilot system was selected;
 - (v) differences in altimeter readings, if alternate static ports selected;
 - (vi) use of air data computer selector for fault diagnosis procedure; and
 - (vii) the transponder selected to provide altitude information to ATC and any difference noted when an alternative transponder was selected.
- (f) Crew training
 - (1) The following items should also be included in flight crew training programmes:
 - (i) knowledge and understanding of standard ATC phraseology used in each area of operations;
 - (ii) importance of crew members cross-checking to ensure that ATC clearances are promptly and correctly complied with;
 - (iii) use and limitations in terms of accuracy of standby altimeters in contingencies. Where applicable, the pilot should review the application of static source error correction/position error correction through the use of correction cards; such correction data should be available on the flight deck;
 - (iv) problems of visual perception of other aircraft at 300 m (1 000 ft) planned separation during darkness, when encountering local phenomena such as northern lights, for opposite and same direction traffic, and during turns;
 - (v) characteristics of aircraft altitude capture systems that may lead to overshoots;
 - (vi) relationship between the aircraft's altimetry, automatic altitude control and transponder systems in normal and abnormal conditions; and
 - (vii) any airframe operating restrictions, if required for the specific aircraft group, related to RVSM airworthiness approval.

GM1 SPA.RVSM.105(d)(9) RVSM operational approval

SPECIFIC REGIONAL PROCEDURES

- (a) The areas of applicability (by Flight Information Region) of RVSM airspace in identified ICAO regions is contained in the relevant sections of ICAO Document 7030/4. In addition, these sections contain operating and contingency procedures unique to the regional airspace concerned, specific flight planning requirements and the approval requirements for aircraft in the designated region.
- (b) Comprehensive guidance on operational matters for European RVSM airspace is contained in EUROCONTROL Document ASM ET1.ST.5000 entitled "The ATC Manual for a Reduced Vertical

Separation (RVSM) in Europe” with further material included in the relevant State aeronautical publications.

SPA.RVSM.110 RVSM equipment requirements

Aircraft used for operations in RVSM airspace shall be equipped with:

- (a) two independent altitude measurement systems;
- (b) an altitude alerting system;
- (c) an automatic altitude control system;
- (d) a secondary surveillance radar (SSR) transponder with altitude reporting system that can be connected to the altitude measurement system in use for altitude control.

AMC1 SPA.RVSM.110(a) RVSM equipment requirements**TWO INDEPENDENT ALTITUDE MEASUREMENT SYSTEMS**

Each system should be composed of the following components:

- (a) cross-coupled static source/system, with ice protection if located in areas subject to ice accretion;
- (b) equipment for measuring static pressure sensed by the static source, converting it to pressure altitude and displaying the pressure altitude to the flight crew;
- (c) equipment for providing a digitally encoded signal corresponding to the displayed pressure altitude, for automatic altitude reporting purposes;
- (d) static source error correction (SSEC), if needed to meet the performance criteria for RVSM flight envelopes; and
- (e) signals referenced to a flight crew selected altitude for automatic control and alerting. These signals will need to be derived from an altitude measurement system meeting the performance criteria for RVSM flight envelopes.

SPA.RVSM.115 RVSM height-keeping errors

- (a) The operator shall report recorded or communicated occurrences of height-keeping errors caused by malfunction of aircraft equipment or of operational nature, equal to or greater than:
 - (1) a total vertical error (TVE) of ± 90 m (± 300 ft);
 - (2) an altimetry system error (ASE) of ± 75 m (± 245 ft); and
 - (3) an assigned altitude deviation (AAD) of ± 90 m (± 300 ft).
- (b) Reports of such occurrences shall be sent to the competent authority within 72 hours. Reports shall include an initial analysis of causal factors and measures taken to prevent repeat occurrences.
- (c) When height-keeping errors are recorded or received, the operator shall take immediate action to rectify the conditions that caused the errors and provide follow-up reports, if requested by the competent authority.

SUBPART E: LOW VISIBILITY OPERATIONS (LVO)

SPA.LVO.100 Low visibility operations

The operator shall only conduct the following low visibility operations (LVO) when approved by the competent authority:

- (a) low visibility take-off (LVTO) operation;
- (b) lower than standard category I (LTS CAT I) operation;
- (c) standard category II (CAT II) operation;
- (d) other than standard category II (OTS CAT II) operation;
- (e) standard category III (CAT III) operation;
- (f) approach operation utilising enhanced vision systems (EVS) for which an operational credit is applied to reduce the runway visual range (RVR) minima by no more than one third of the published RVR.

AMC1 SPA.LVO.100 Low visibility operations

LVTO OPERATIONS – AEROPLANES

For a low visibility take-off (LVTO) with an aeroplane the following provisions should apply:

- (a) for an LVTO with a runway visual range (RVR) below 400 m the criteria specified in Table 1.A;
- (b) for an LVTO with an RVR below 150 m but not less than 125 m:
 - (1) high intensity runway centre line lights spaced 15 m or less apart and high intensity edge lights spaced 60 m or less apart that are in operation;
 - (2) a 90 m visual segment that is available from the flight crew compartment at the start of the take-off run; and
 - (3) the required RVR value is achieved for all of the relevant RVR reporting points;
- (c) for an LVTO with an RVR below 125 m but not less than 75 m:
 - (1) runway protection and facilities equivalent to CAT III landing operations are available; and
 - (2) the aircraft is equipped with an approved lateral guidance system.

Table 1.A: LVTO – aeroplanes
RVR vs. facilities

Facilities	RVR (m) *, **
Day: runway edge lights and runway centre line markings Night: runway edge lights and runway end lights or runway centre line lights and runway end lights	300
Runway edge lights and runway centre line lights	200

Facilities	RVR (m) *, **
Runway edge lights and runway centre line lights	TDZ, MID, rollout 150***
High intensity runway centre line lights spaced 15 m or less and high intensity edge lights spaced 60 m or less are in operation	TDZ, MID, rollout 125***
Runway protection and facilities equivalent to CAT III landing operations are available and the aircraft is equipped either with an approved lateral guidance system or an approved HUD / HUDLS for take-off.	TDZ, MID, rollout 75

*: The reported RVR value representative of the initial part of the take-off run can be replaced by pilot assessment.

** : Multi-engined aeroplanes that in the event of an engine failure at any point during take-off can either stop or continue the take-off to a height of 1 500 ft above the aerodrome while clearing obstacles by the required margins.

***: The required RVR value to be achieved for all relevant RVRs

TDZ: touchdown zone, equivalent to the initial part of the take-off run

MID: midpoint

AMC2 SPA.LVO.100 Low visibility operations

LVTO OPERATIONS – HELICOPTERS

For LVTOs with helicopters the provisions specified in Table 1.H should apply.

Table 1.H: LVTO – helicopters

RVR vs. facilities

Facilities	RVR (m)
Onshore aerodromes with IFR departure procedures	
No light and no markings (day only)	250 or the rejected take-off distance, whichever is the greater
No markings (night)	800
Runway edge/FATO light and centre line marking	200
Runway edge/FATO light, centre line marking and relevant RVR information	150
Offshore helideck *	
Two-pilot operations	250
Single-pilot operations	500

*: The take-off flight path to be free of obstacles

FATO: final approach and take-off area

AMC3 SPA.LVO.100 Low visibility operations

LTS CAT I OPERATIONS

- (a) For lower than Standard Category I (LTS CAT I) operations the following provisions should apply:
- (1) The decision height (DH) of an LTS CAT I operation should not be lower than the highest of:
 - (i) the minimum DH specified in the AFM, if stated;
 - (ii) the minimum height to which the precision approach aid can be used without the specified visual reference;
 - (iii) the applicable obstacle clearance height (OCH) for the category of aeroplane;
 - (iv) the DH to which the flight crew is qualified to operate; or
 - (v) 200 ft.
 - (2) An instrument landing system / microwave landing system (ILS/MLS) that supports an LTS CAT I operation should be an unrestricted facility with a straight-in course, $\leq 3^\circ$ offset, and the ILS should be certified to:
 - (i) class I/T/1 for operations to a minimum of 450 m RVR; or
 - (ii) class II/D/2 for operations to less than 450 m RVR.

Single ILS facilities are only acceptable if level 2 performance is provided.
 - (3) The following visual aids should be available:
 - (i) standard runway day markings, approach lights, runway edge lights, threshold lights and runway end lights;
 - (ii) for operations with an RVR below 450 m, additionally touch-down zone and/or runway centre line lights.
 - (4) The lowest RVR / converted meteorological visibility (CMV) minima to be used are specified in Table 2.

**Table 2: LTS CAT I operation minima
RVR/CMV vs. approach lighting system**

DH (ft)	Class of light facility *			
	FALS	IALS	BALS	NALS
	RVR/CMV (m)			
200 – 210	400	500	600	750
211 – 220	450	550	650	800
221 – 230	500	600	700	900

231 – 240	500	650	750	1 000
241 – 249	550	700	800	1 100

- *: FALS: full approach lighting system
IALS: intermediate approach lighting system
BALS: basic approach lighting system
NALS: no approach lighting system

AMC4 SPA.LVO.100 Low visibility operations

CAT II AND OTS CAT II OPERATIONS

- (a) For CAT II and other than Standard Category II (OTS CAT II) operations the following provisions should apply:
- (1) The ILS / MLS that supports OTS CAT II operation should be an unrestricted facility with a straight in course ($\leq 3^\circ$ offset) and the ILS should be certified to class II/D/2.
Single ILS facilities are only acceptable if level 2 performance is provided.
 - (2) The DH for CAT II and OTS CAT II operation should not be lower than the highest of:
 - (i) the minimum DH specified in the AFM, if stated;
 - (ii) the minimum height to which the precision approach aid can be used without the specified visual reference;
 - (iii) the applicable OCH for the category of aeroplane;
 - (iv) the DH to which the flight crew is qualified to operate; or
 - (v) 100 ft.
 - (3) The following visual aids should be available:
 - (i) standard runway day markings and approach and the following runway lights: runway edge lights, threshold lights and runway end lights;
 - (ii) for operations in RVR below 450 m, additionally touch-down zone and/or runway centre line lights;
 - (iii) for operations with an RVR of 400 m or less, additionally centre line lights.
 - (4) The lowest RVR minima to be used are specified:
 - (i) for CAT II operations in Table 3; and
 - (ii) for OTS CAT II operations in Table 4.
- (b) For OTS CAT II operations, the terrain ahead of the runway threshold should have been surveyed.

**Table 3: CAT II operation minima
RVR vs. DH**

DH (ft)	Auto-coupled or approved HUDLS to below DH *	
	Aircraft categories A, B, C RVR (m)	Aircraft category D RVR (m)
100 – 120	300	300/350**
121 – 140	400	400
141 – 199	450	450

*: This means continued use of the automatic flight control system or the HUDLS down to a height of 80 % of the DH.

** : An RVR of 300 m may be used for a category D aircraft conducting an auto-land.

**Table 4: OTS CAT II operation minima
RVR vs. approach lighting system**

DH (ft)	Auto-land or approved HUDLS utilised to touchdown				
	Class of light facility				
	FALS		IALS	BALS	NALS
	Aircraft categories A – C	Aircraft category D	Aircraft categories A – D	Aircraft categories A – D	Aircraft categories A – D
	RVR (m)				
100 - 120	350	400	450	600	700
121 - 140	400	450	500	600	700
141 - 160	400	500	500	600	750
161 - 199	400	500	550	650	750

AMC5 SPA.LVO.100 Low visibility operations**CAT III OPERATIONS**

The following provisions should apply to CAT III operations:

- (a) Where the DH and RVR do not fall within the same category, the RVR should determine in which category the operation is to be considered.
- (b) For operations in which a DH is used, the DH should not be lower than:

- (1) the minimum DH specified in the AFM, if stated;
 - (2) the minimum height to which the precision approach aid can be used without the specified visual reference; or
 - (3) the DH to which the flight crew is qualified to operate.
- (c) Operations with no DH should only be conducted if:
- (1) the operation with no DH is specified in the AFM;
 - (2) the approach aid and the aerodrome facilities can support operations with no DH; and
 - (3) the flight crew is qualified to operate with no DH.
- (d) The lowest RVR minima to be used are specified in Table 5.

**Table 5: CAT III operations minima
RVR vs. DH and rollout control/guidance system**

CAT	DH (ft) *	Rollout control/guidance system	RVR (m)
IIIA	Less than 100	Not required	200
IIIB	Less than 100	Fail-passive	150**
IIIB	Less than 50	Fail-passive	125
IIIB	Less than 50 or no DH	Fail-operational ***	75

*: Flight control system redundancy is determined under CS-AWO by the minimum certified DH.

** : For aeroplanes certified in accordance with CS-AWO 321(b)(3) or equivalent.

***: The fail-operational system referred to may consist of a fail-operational hybrid system.

AMC6 SPA.LVO.100 Low visibility operations

OPERATIONS UTILISING EVS

The pilot using a certified enhanced vision system (EVS) in accordance with the procedures and limitations of the AFM:

- (a) may reduce the RVR/CMV value in column 1 to the value in column 2 of Table 6 for CAT I operations, APV operations and NPA operations flown with the CDFA technique;
- (b) for CAT I operations:
 - (1) may continue an approach below DH to 100 ft above the runway threshold elevation provided that a visual reference is displayed and identifiable on the EVS image; and
 - (2) should only continue an approach below 100 ft above the runway threshold elevation provided that a visual reference is distinctly visible and identifiable to the pilot without reliance on the EVS;
- (c) for APV operations and NPA operations flown with the CDFA technique:

- (1) may continue an approach below DH/MDH to 200 ft above the runway threshold elevation provided that a visual reference is displayed and identifiable on the EVS image; and
- (2) should only continue an approach below 200 ft above the runway threshold elevation provided that a visual reference is distinctly visible and identifiable to the pilot without reliance on the EVS.

**Table 6: Operations utilising EVS
RVR/CMV reduction vs. normal RVR/CMV**

RVR/CMV (m) normally required	RVR/CMV (m) utilising EVS
550	350
600	400
650	450
700	450
750	500
800	550
900	600
1 000	650
1 100	750
1 200	800
1 300	900
1 400	900
1 500	1 000
1 600	1 100
1 700	1 100
1 800	1 200
1 900	1 300
2 000	1 300
2 100	1 400
2 200	1 500
2 300	1 500
2 400	1 600
2 500	1 700
2 600	1 700
2 700	1 800
2 800	1 900
2 900	1 900

RVR/CMV (m) normally required	RVR/CMV (m) utilising EVS
3 000	2 000
3 100	2 000
3 200	2 100
3 300	2 200
3 400	2 200
3 500	2 300
3 600	2 400
3 700	2 400
3 800	2 500
3 900	2 600
4 000	2 600
4 100	2 700
4 200	2 800
4 300	2 800
4 400	2 900
4 500	3 000
4 600	3 000
4 700	3 100
4 800	3 200
4 900	3 200
5 000	3 300

AMC7 SPA.LVO.100 Low visibility operations

EFFECT ON LANDING MINIMA OF TEMPORARILY FAILED OR DOWNGRADED EQUIPMENT

(a) General

These instructions are intended for use both pre-flight and in-flight. It is however not expected that the pilot-in-command/commander would consult such instructions after passing 1 000 ft above the aerodrome. If failures of ground aids are announced at such a late stage, the approach could be continued at the pilot-in-command/commander's discretion. If failures are announced before such a late stage in the approach, their effect on the approach should be considered as described in Table 7, and the approach may have to be abandoned.

(b) The following conditions should be applicable to the tables below:

- (1) multiple failures of runway/FATO lights other than indicated in Table 7 are not acceptable;
- (2) deficiencies of approach and runway/FATO lights are treated separately;

- (3) for CAT II and CAT III operations, a combination of deficiencies in runway/FATO lights and RVR assessment equipment are not permitted; and
- (4) failures other than ILS and MLS affect RVR only and not DH.

**Table 7: Failed or downgraded equipment – affect on landing minima
Operations with an LVO approval**

Failed or downgraded equipment	Effect on landing minima			
	CAT IIIB (no DH)	CAT IIIB	CAT IIIA	CAT II
ILS/MLS stand-by transmitter	Not allowed	RVR 200 m	No effect	
Outer marker	No effect if replaced by height check at 1 000 ft			
Middle marker	No effect			
RVR assessment systems	At least one RVR value to be available on the aerodrome	On runways equipped with two or more RVR assessment units, one may be inoperative		
Approach lights	No effect	Not allowed for operations with DH >50 ft	Not allowed	
Approach lights except the last 210 m	No effect		Not allowed	
Approach lights except the last 420 m	No effect			
Standby power for approach lights	No effect			
Edge lights, threshold lights and runway end lights	No effect		Day: no effect	Day: no effect
			Night: RVR 550 m	Night: not allowed
Centre line lights	Day: RVR 200 m	Not allowed	Day: RVR 300 m	Day: RVR 350 m
	Night: not allowed		Night: RVR 400 m	Night: RVR 550 m (400 m with HUDLS or auto-land)
Centre line lights spacing increased to 30 m	RVR 150 m		No effect	

Failed or downgraded equipment	Effect on landing minima			
	CAT IIIB (no DH)	CAT IIIB	CAT IIIA	CAT II
Touchdown zone lights	No effect	Day: RVR 200 m	Day: RVR 300 m	
		Night: RVR 300 m	Night: RVR 550 m, 350 m with HUDLS or auto-land	
Taxiway light system	No effect			

GM1 SPA.LVO.100 Low visibility operations

DOCUMENTS CONTAINING INFORMATION RELATED TO LOW VISIBILITY OPERATIONS

The following documents provide further information to low visibility operations (LVO):

- (a) ICAO Annex 2 Rules of the Air;
- (b) ICAO Annex 6 Operation of Aircraft;
- (c) ICAO Annex 10 Telecommunications Vol. 1;
- (d) ICAO Annex 14 Aerodromes Vol. 1;
- (e) ICAO Doc 8168 PANS - OPS Aircraft Operations;
- (f) ICAO Doc 9365 AWO Manual;
- (g) ICAO Doc 9476 Manual of surface movement guidance and control systems (SMGCS);
- (h) ICAO Doc 9157 Aerodrome Design Manual;
- (i) ICAO Doc 9328 Manual of RVR Observing and Reporting Practices;
- (j) ICAO EUR Doc 013: European Guidance Material on Aerodrome Operations under Limited Visibility Conditions;
- (k) ECAC Doc 17, Issue 3; and
- (l) CS-AWO All weather operations.

GM2 SPA.LVO.100 Low visibility operations

ILS CLASSIFICATION

The ILS classification system is specified in ICAO Annex 10.

GM1 SPA.LVO.100(c),(e) Low visibility operations

ESTABLISHMENT OF MINIMUM RVR FOR CAT II AND CAT III OPERATIONS

- (a) General

- (1) When establishing minimum RVR for CAT II and CAT III operations, operators should pay attention to the following information that originates in ECAC Doc 17 3rd Edition, Subpart A. It is retained as background information and, to some extent, for historical purposes although there may be some conflict with current practices.
- (2) Since the inception of precision approach and landing operations various methods have been devised for the calculation of aerodrome operating minima in terms of DH and RVR. It is a comparatively straightforward matter to establish the DH for an operation but establishing the minimum RVR to be associated with that DH so as to provide a high probability that the required visual reference will be available at that DH has been more of a problem.
- (3) The methods adopted by various States to resolve the DH/RVR relationship in respect of CAT II and CAT III operations have varied considerably. In one instance there has been a simple approach that entailed the application of empirical data based on actual operating experience in a particular environment. This has given satisfactory results for application within the environment for which it was developed. In another instance a more sophisticated method was employed which utilised a fairly complex computer programme to take account of a wide range of variables. However, in the latter case, it has been found that with the improvement in the performance of visual aids, and the increased use of automatic equipment in the many different types of new aircraft, most of the variables cancel each other out and a simple tabulation can be constructed that is applicable to a wide range of aircraft. The basic principles that are observed in establishing the values in such a table are that the scale of visual reference required by a pilot at and below DH depends on the task that he/she has to carry out, and that the degree to which his/her vision is obscured depends on the obscuring medium, the general rule in fog being that it becomes more dense with increase in height. Research using flight simulation training devices (FSTDs) coupled with flight trials has shown the following:
 - (i) most pilots require visual contact to be established about 3 seconds above DH though it has been observed that this reduces to about 1 second when a fail-operational automatic landing system is being used;
 - (ii) to establish lateral position and cross-track velocity most pilots need to see not less than a three light segment of the centre line of the approach lights, or runway centre line, or runway edge lights;
 - (iii) for roll guidance most pilots need to see a lateral element of the ground pattern, i.e. an approach light cross bar, the landing threshold, or a barrette of the touchdown zone light; and
 - (iv) to make an accurate adjustment to the flight path in the vertical plane, such as a flare, using purely visual cues, most pilots need to see a point on the ground which has a low or zero rate of apparent movement relative to the aircraft.
 - (v) With regard to fog structure, data gathered in the United Kingdom over a 20 year period have shown that in deep stable fog there is a 90 % probability that the slant visual range from eye heights higher than 15 ft above the ground will be less than the horizontal visibility at ground level, i.e. RVR. There are at present no data available to show what the relationship is between the slant visual range and RVR in other low visibility conditions such as blowing snow, dust or heavy rain, but there is some evidence in pilot reports that the lack of contrast between visual aids and the background in such conditions can produce a relationship similar to that observed in fog.

(b) CAT II operations

The selection of the dimensions of the required visual segments that are used for CAT II operations is based on the following visual provisions:

- (1) a visual segment of not less than 90 m will need to be in view at and below DH for pilot to be able to monitor an automatic system;
- (2) a visual segment of not less than 120 m will need to be in view for a pilot to be able to maintain the roll attitude manually at and below DH; and
- (3) for a manual landing using only external visual cues, a visual segment of 225 m will be required at the height at which flare initiation starts in order to provide the pilot with sight of a point of low relative movement on the ground.

Before using a CAT II ILS for landing, the quality of the localiser between 50 ft and touchdown should be verified.

(c) CAT III fail-passive operations

- (1) CAT III operations utilising fail-passive automatic landing equipment were introduced in the late 1960s and it is desirable that the principles governing the establishment of the minimum RVR for such operations be dealt with in some detail.
- (2) During an automatic landing the pilot needs to monitor the performance of the aircraft system, not in order to detect a failure that is better done by the monitoring devices built into the system, but so as to know precisely the flight situation. In the final stages the pilot should establish visual contact and, by the time the pilot reaches DH, the pilot should have checked the aircraft position relative to the approach or runway centre line lights. For this the pilot will need sight of horizontal elements (for roll reference) and part of the touchdown area. The pilot should check for lateral position and cross-track velocity and, if not within the pre-stated lateral limits, the pilot should carry out a missed approach procedure. The pilot should also check longitudinal progress and sight of the landing threshold is useful for this purpose, as is sight of the touchdown zone lights.
- (3) In the event of a failure of the automatic flight guidance system below DH, there are two possible courses of action; the first is a procedure that allows the pilot to complete the landing manually if there is adequate visual reference for him/her to do so, or to initiate a missed approach procedure if there is not; the second is to make a missed approach procedure mandatory if there is a system disconnect regardless of the pilot's assessment of the visual reference available:
 - (i) If the first option is selected then the overriding rule in the determination of a minimum RVR is for sufficient visual cues to be available at and below DH for the pilot to be able to carry out a manual landing. Data presented in ECAC Doc 17 showed that a minimum value of 300 m would give a high probability that the cues needed by the pilot to assess the aircraft in pitch and roll will be available and this should be the minimum RVR for this procedure.
 - (ii) The second option, to require a missed approach procedure to be carried out should the automatic flight-guidance system fail below DH, will permit a lower minimum RVR because the visual reference provision will be less if there is no need to provide for the possibility of a manual landing. However, this option is only acceptable if it can be shown that the probability of a system failure below DH is acceptably low. It should be recognised that the inclination of a pilot who experiences such a failure would be to continue the landing manually but the results of flight trials in actual

conditions and of simulator experiments show that pilots do not always recognise that the visual cues are inadequate in such situations and present recorded data reveal that pilots' landing performance reduces progressively as the RVR is reduced below 300 m. It should further be recognised that there is some risk in carrying out a manual missed approach procedure from below 50 ft in very low visibility and it should therefore be accepted that if an RVR lower than 300 m is to be approved, the flight deck procedure should not normally allow the pilot to continue the landing manually in such conditions and the aircraft system should be sufficiently reliable for the missed approach procedure rate to be low.

- (4) These criteria may be relaxed in the case of an aircraft with a fail-passive automatic landing system that is supplemented by a head-up display that does not qualify as a fail-operational system but that gives guidance that will enable the pilot to complete a landing in the event of a failure of the automatic landing system. In this case it is not necessary to make a missed approach procedure mandatory in the event of a failure of the automatic landing system when the RVR is less than 300 m.
- (d) CAT III fail-operational operations - with a DH
- (1) For CAT III operations utilising a fail-operational landing system with a DH, a pilot should be able to see at least one centre line light.
 - (2) For CAT III operations utilising a fail-operational hybrid landing system with a DH, a pilot should have a visual reference containing a segment of at least three consecutive lights of the runway centre line lights.
- (e) CAT III fail operational operations - with no DH
- (1) For CAT III operations with no DH the pilot is not required to see the runway prior to touchdown. The permitted RVR is dependent on the level of aircraft equipment.
 - (2) A CAT III runway may be assumed to support operations with no DH unless specifically restricted as published in the AIP or NOTAM.

GM1 SPA.LVO.100(e) Low visibility operations

CREW ACTIONS IN CASE OF AUTOPILOT FAILURE AT OR BELOW DH IN FAIL-PASSIVE CAT III OPERATIONS

For operations to actual RVR values less than 300 m, a missed approach procedure is assumed in the event of an autopilot failure at or below DH. This means that a missed approach procedure is the normal action. However, the wording recognises that there may be circumstances where the safest action is to continue the landing. Such circumstances include the height at which the failure occurs, the actual visual references, and other malfunctions. This would typically apply to the late stages of the flare. In conclusion, it is not forbidden to continue the approach and complete the landing when the pilot-in-command/commander determines that this is the safest course of action. The operator's policy and the operational instructions should reflect this information.

GM1 SPA.LVO.100(f) Low visibility operations

OPERATIONS UTILISING EVS

- (a) Introduction
- (1) Enhanced vision systems use sensing technology to improve a pilot's ability to detect objects, such as runway lights or terrain, which may otherwise not be visible. The image

produced from the sensor and/or image processor can be displayed to the pilot in a number of ways including use of a HUD. The systems can be used in all phases of flight and can improve situational awareness. In particular, infra-red systems can display terrain during operations at night, improve situational awareness during night and low-visibility taxiing, and may allow earlier acquisition of visual references during instrument approaches.

(b) Background to EVS provisions

- (1) The provisions for EVS were developed after an operational evaluation of two different EVS systems, along with data and support provided by the FAA. Approaches using EVS were flown in a variety of conditions including fog, rain and snow showers, as well as at night to aerodromes located in mountainous terrain. The infra-red EVS performance can vary depending on the weather conditions encountered. Therefore, the provisions take a conservative approach to cater for the wide variety of conditions which may be encountered. It may be necessary to amend the provisions in the future to take account of greater operational experience.
- (2) Provisions for the use of EVS during take-off have not been developed. The systems evaluated did not perform well when the RVR was below 300 m. There may be some benefit for use of EVS during take-off with greater visibility and reduced light; however, such operations would need to be evaluated.
- (3) Provisions have been developed to cover use of infra-red systems only. Other sensing technologies are not intended to be excluded; however, their use will need to be evaluated to determine the appropriateness of this, or any other provision. During the development, it was envisaged what minimum equipment should be fitted to the aircraft. Given the present state of technological development, it is considered that a HUD is an essential element of the EVS equipment.
- (4) In order to avoid the need for tailored charts for approaches utilising EVS, it is envisaged that the operator will use AMC6 SPA.LVO.110 Table 6 Operations utilising EVS RVR/CMV reduction vs. normal RVR/CMV to determine the applicable RVR at the commencement of the approach.

(c) Additional operational considerations

- (1) EVS equipment should have:
 - (i) a head-up display system (capable of displaying, airspeed, vertical speed, aircraft attitude, heading, altitude, command guidance as appropriate for the approach to be flown, path deviation indications, flight path vector and flight path angle reference cue and the EVS imagery);
 - (ii) a head-down view of the EVS image, or other means of displaying the EVS-derived information easily to the pilot monitoring the progress of the approach; and
 - (iii) means to ensure that the pilot monitoring is kept in the 'loop' and crew resource management (CRM) does not break down.

SPA.LVO.105 LVO approval

To obtain an LVO approval from the competent authority, the operator shall demonstrate compliance with the requirements of this Subpart.

AMC1 SPA.LVO.105 LVO approval

OPERATIONAL DEMONSTRATION – AEROPLANES

(a) General

- (1) The purpose of the operational demonstration should be to determine or validate the use and effectiveness of the applicable aircraft flight guidance systems, including HUDLS if appropriate, training, flight crew procedures, maintenance programme, and manuals applicable to the CAT II/III programme being approved.
 - (i) At least 30 approaches and landings should be accomplished in operations using the CAT II/III systems installed in each aircraft type if the requested DH is 50 ft or higher. If the DH is less than 50 ft, at least 100 approaches and landings should be accomplished.
 - (ii) If the operator has different variants of the same type of aircraft utilising the same basic flight control and display systems, or different basic flight control and display systems on the same type of aircraft, the operator should show that the various variants have satisfactory performance, but need not conduct a full operational demonstration for each variant. The number of approaches and landings may be based on credit given for the experience gained by another operator, using the same aeroplane type or variant and procedures.
 - (iii) If the number of unsuccessful approaches exceeds 5 % of the total, e.g. unsatisfactory landings, system disconnects, the evaluation programme should be extended in steps of at least 10 approaches and landings until the overall failure rate does not exceed 5 %.
- (2) The operator should establish a data collection method to record approach and landing performance. The resulting data and a summary of the demonstration data should be made available to the competent authority for evaluation.
- (3) Unsatisfactory approaches and/or automatic landings should be documented and analysed.

(b) Demonstrations

- (1) Demonstrations may be conducted in line operations or any other flight where the operator's procedures are being used.
- (2) In unique situations where the completion of 100 successful landings could take an unreasonably long period of time and equivalent reliability assurance can be achieved, a reduction in the required number of landings may be considered on a case-by-case basis. Reduction of the number of landings to be demonstrated requires a justification for the reduction. This justification should take into account factors such as a small number of aircraft in the fleet, limited opportunity to use runways having CAT II/III procedures or the inability to obtain ATS sensitive area protection during good weather conditions. However, at the operator's option, demonstrations may be made on other runways and facilities. Sufficient information should be collected to determine the cause of any unsatisfactory performance (e.g. sensitive area was not protected).

- (3) If the operator has different variants of the same type of aircraft utilising the same basic flight control and display systems, or different basic flight control and display systems on the same type or class of aircraft, the operator should show that the various variants have satisfactory performance, but need not conduct a full operational demonstration for each variant.
 - (4) Not more than 30 % of the demonstration flights should be made on the same runway.
- (c) Data collection for operational demonstrations
- (1) Data should be collected whenever an approach and landing is attempted utilising the CAT II/III system, regardless of whether the approach is abandoned, unsatisfactory, or is concluded successfully.
 - (2) The data should, as a minimum, include the following information:
 - (i) Inability to initiate an approach. Identify deficiencies related to airborne equipment that preclude initiation of a CAT II/III approach.
 - (ii) Abandoned approaches. Give the reasons and altitude above the runway at which approach was discontinued or the automatic landing system was disengaged.
 - (iii) Touchdown or touchdown and rollout performance. Describe whether or not the aircraft landed satisfactorily within the desired touchdown area with lateral velocity or cross track error that could be corrected by the pilot or automatic system so as to remain within the lateral confines of the runway without unusual pilot skill or technique. The approximate lateral and longitudinal position of the actual touchdown point in relation to the runway centre line and the runway threshold, respectively, should be indicated in the report. This report should also include any CAT II/III system abnormalities that required manual intervention by the pilot to ensure a safe touchdown or touchdown and rollout, as appropriate.
- (d) Data analysis
- Unsuccessful approaches due to the following factors may be excluded from the analysis:
- (1) ATS factors. Examples include situations in which a flight is vectored too close to the final approach fix/point for adequate localiser and glide slope capture, lack of protection of ILS sensitive areas, or ATS requests the flight to discontinue the approach.
 - (2) Faulty navaid signals. Navaid (e.g. ILS localiser) irregularities, such as those caused by other aircraft taxiing, over-flying the navaid (antenna).
 - (3) Other factors. Any other specific factors that could affect the success of CAT II/ III operations that are clearly discernible to the flight crew should be reported.

AMC2 SPA.LVO.105 LVO approval

OPERATIONAL DEMONSTRATION – HELICOPTERS

- (a) The operator should comply with the provisions prescribed below when introducing into CAT II or III service a helicopter type that is new to the EU.
- (1) Operational reliability
The CAT II and III success rate should not be less than that required by CS-AWO or equivalent.
 - (2) Criteria for a successful approach

An approach is regarded as successful if:

- (i) the criteria are as specified in CS-AWO or equivalent are met; and
- (ii) no relevant helicopter system failure occurs.

For helicopter types already used for CAT II or III operations in another Member State, the in-service proving programme in (e) should be used instead.

(b) Data collection during airborne system demonstration - general

- (1) The operator should establish a reporting system to enable checks and periodic reviews to be made during the operational evaluation period before the operator is approved to conduct CAT II or III operations. The reporting system should cover all successful and unsuccessful approaches, with reasons for the latter, and include a record of system component failures. This reporting system should be based upon flight crew reports and automatic recordings as prescribed in (c) and (d) below.
- (2) The recordings of approaches may be made during normal line flights or during other flights performed by the operator.

(c) Data collection during airborne system demonstration – operations with DH not less than 50 ft

- (1) For operations with DH not less than 50 ft, data should be recorded and evaluated by the operator and evaluated by the competent authority when necessary.
- (2) It is sufficient for the following data to be recorded by the flight crew:
 - (i) FATO and runway used;
 - (ii) weather conditions;
 - (iii) time;
 - (iv) reason for failure leading to an aborted approach;
 - (v) adequacy of speed control;
 - (vi) trim at time of automatic flight control system disengagement;
 - (vii) compatibility of automatic flight control system, flight director and raw data;
 - (viii) an indication of the position of the helicopter relative to the ILS, MLS centre line when descending through 30 m (100 ft); and
 - (ix) touchdown position.
- (3) The number of approaches made during the initial evaluation should be sufficient to demonstrate that the performance of the system in actual airline service is such that a 90 % confidence and a 95 % approach success will result.

(d) Data collection during airborne system demonstration – operations with DH less than 50 ft or no DH

- (1) For operations with DH less than 50 ft or no DH, a flight data recorder (FDR), or other equipment giving the appropriate information, should be used in addition to the flight crew reports to confirm that the system performs as designed in actual airline service. The following data should be recorded:
 - (i) distribution of ILS, MLS deviations at 30 m (100 ft), at touchdown and, if appropriate, at disconnection of the rollout control system and the maximum values of the deviations between those points; and

- (ii) sink rate at touchdown.
 - (2) Any landing irregularity should be fully investigated using all available data to determine its cause.
- (e) In-service proving
- The operator fulfilling the provisions of (f) above should be deemed to have met the in-service proving contained in this subparagraph.
- (1) The system should demonstrate reliability and performance in line operations consistent with the operational concepts. A sufficient number of successful landings should be accomplished in line operations, including training flights, using the auto-land and rollout system installed in each helicopter type.
 - (2) The demonstration should be accomplished using a CAT II or CAT III ILS. Demonstrations may be made on other ILS or MLS facilities if sufficient data are recorded to determine the cause of unsatisfactory performance.
 - (3) If the operator has different variants of the same type of helicopter utilising the same basic flight control and display systems, or different basic flight control and display systems on the same type of helicopter, the operator should show that the variants comply with the basic system performance criteria, but the operator need not conduct a full operational demonstration for each variant.
 - (4) Where the operator introduces a helicopter type that has already been approved by the competent authority of any Member State for CAT II and/or CAT III operations, a reduced proving programme may be acceptable.

AMC3 SPA.LVO.105 LVO approval

CONTINUOUS MONITORING – ALL AIRCRAFT

- (a) After obtaining the initial approval, the operations should be continuously monitored by the operator to detect any undesirable trends before they become hazardous. Flight crew reports may be used to achieve this.
- (b) The following information should be retained for a period of 12 months:
 - (1) the total number of approaches, by aircraft type, where the airborne CAT II or III equipment was utilised to make satisfactory, actual or practice, approaches to the applicable CAT II or III minima; and
 - (2) reports of unsatisfactory approaches and/or automatic landings, by aerodrome and aircraft registration, in the following categories:
 - (i) airborne equipment faults;
 - (ii) ground facility difficulties;
 - (iii) missed approaches because of ATC instructions; or
 - (iv) other reasons.
- (c) The operator should establish a procedure to monitor the performance of the automatic landing system or HUDLS to touchdown performance, as appropriate, of each aircraft.

AMC4 SPA.LVO.105 LVO approval

TRANSITIONAL PERIODS FOR CAT II AND CAT III OPERATIONS

- (a) Operators with no previous CAT II or CAT III experience
- (1) The operator without previous CAT II or III operational experience, applying for a CAT II or CAT IIIA operational approval, should demonstrate to the competent authority that it has gained a minimum experience of 6 months of CAT I operations on the aircraft type.
 - (2) The operator applying for a CAT IIIB operational approval should demonstrate to the competent authority that it has already completed 6 months of CAT II or IIIA operations on the aircraft type.
- (b) Operators with previous CAT II or III experience
- (1) The operator with previous CAT II or CAT III experience, applying for a CAT II or CAT III operational approval with reduced transition periods as set out in (a), should demonstrate to the competent authority that it has maintained the experience previously gained on the aircraft type.
 - (2) The operator approved for CAT II or III operations using auto-coupled approach procedures, with or without auto-land, and subsequently introducing manually flown CAT II or III operations using a HUDLS should provide the operational demonstrations set out in AMC1 SPA.LVO.105 and AMC2 SPA.LVO.105 as if it would be a new applicant for a CAT II or CAT III approval.

AMC5 SPA.LVO.105 LVO approval

MAINTENANCE OF CAT II, CAT III AND LVTO EQUIPMENT

Maintenance instructions for the on-board guidance systems should be established by the operator, in liaison with the manufacturer, and included in the operator's aircraft maintenance programme in accordance with Annex I to Regulation (EC) No 2042/2003¹ (Part-M).

AMC6 SPA.LVO.105 LVO approval

ELIGIBLE AERODROMES AND RUNWAYS

- (a) Each aircraft type/runway combination should be verified by the successful completion of at least one approach and landing in CAT II or better conditions, prior to commencing CAT III operations.
- (b) For runways with irregular pre-threshold terrain or other foreseeable or known deficiencies, each aircraft type/runway combination should be verified by operations in CAT I or better conditions, prior to commencing LTS CAT I, OTS CAT II or CAT III operations.
- (c) If the operator has different variants of the same type of aircraft in accordance with (d), utilising the same basic flight control and display systems, or different basic flight control and display systems on the same type of aircraft in accordance with (d), the operator should show that the

¹ OJ L 315, 28.11.2003, p. 1.

variants have satisfactory operational performance, but need not conduct a full operational demonstration for each variant/runway combination.

- (d) For the purpose of this AMC, an aircraft type or variant of an aircraft type should be deemed to be the same type/variant of aircraft if that type/variant has the same or similar:
- (1) level of technology, including the following:
 - (i) flight control/guidance system (FGS) and associated displays and controls;
 - (ii) FMS and level of integration with the FGS; and
 - (iii) use of HUDLS;
 - (2) operational procedures, including:
 - (i) alert height;
 - (ii) manual landing /automatic landing;
 - (iii) no DH operations; and
 - (iv) use of HUD/HUDLS in hybrid operations;
 - (3) handling characteristics, including:
 - (i) manual landing from automatic or HUDLS guided approach;
 - (ii) manual missed approach procedure from automatic approach; and
 - (iii) automatic/manual rollout.
- (e) Operators using the same aircraft type/class or variant of a type in accordance with (d) above may take credit from each other's experience and records in complying with this subparagraph.
- (f) Where an approval is sought for OTS CAT II, the same provisions as set out for CAT II should be applied.

GM1 SPA.LVO.105 LVO approval

CRITERIA FOR A SUCCESSFUL CAT II, OTS CAT II, CAT III APPROACH AND AUTOMATIC LANDING

- (a) The purpose of this GM is to provide operators with supplemental information regarding the criteria for a successful approach and landing to facilitate fulfilling the requirements prescribed in SPA.LVO.105.
- (b) An approach may be considered to be successful if:
- (1) from 500 ft to start of flare:
 - (i) speed is maintained as specified in AMC-AWO 231, paragraph 2 'Speed Control'; and
 - (ii) no relevant system failure occurs;and
 - (2) from 300 ft to DH:
 - (i) no excess deviation occurs; and
 - (ii) no centralised warning gives a missed approach procedure command (if installed).
- (c) An automatic landing may be considered to be successful if:
- (1) no relevant system failure occurs;

-
- (2) no flare failure occurs;
 - (3) no de-crab failure occurs (if installed);
 - (4) longitudinal touchdown is beyond a point on the runway 60 m after the threshold and before the end of the touchdown zone light (900 m from the threshold);
 - (5) lateral touchdown with the outboard landing gear is not outside the touchdown zone light edge;
 - (6) sink rate is not excessive;
 - (7) bank angle does not exceed a bank angle limit; and
 - (8) no rollout failure or deviation (if installed) occurs.
- (d) More details can be found in CS-AWO 131, CS-AWO 231 and AMC-AWO 231.

SPA.LVO.110 General operating requirements

- (a) The operator shall only conduct LTS CAT I operations if:
- (1) each aircraft concerned is certified for operations to conduct CAT II operations; and
 - (2) the approach is flown:
 - (i) auto-coupled to an auto-land that needs to be approved for CAT IIIA operations; or
 - (ii) using an approved head-up display landing system (HUDLS) to at least 150 ft above the threshold.
- (b) The operator shall only conduct CAT II, OTS CAT II or CAT III operations if:
- (1) each aircraft concerned is certified for operations with a decision height (DH) below 200 ft, or no DH, and equipped in accordance with the applicable airworthiness requirements;
 - (2) a system for recording approach and/or automatic landing success and failure is established and maintained to monitor the overall safety of the operation;
 - (3) the DH is determined by means of a radio altimeter;
 - (4) the flight crew consists of at least two pilots;
 - (5) all height call-outs below 200 ft above the aerodrome threshold elevation are determined by a radio altimeter.
- (c) The operator shall only conduct approach operations utilising an EVS if:
- (1) the EVS is certified for the purpose of this Subpart and combines infra-red sensor image and flight information on the HUD;
 - (2) for operations with an RVR below 550 m, the flight crew consists of at least two pilots;
 - (3) for CAT I operations, natural visual reference to runway cues is attained at least at 100 ft above the aerodrome threshold elevation;
 - (4) for approach procedure with vertical guidance (APV) and non-precision approach (NPA) operations flown with CDFA technique, natural visual reference to runway cues is attained at least at 200 ft above the aerodrome threshold elevation and the following requirements are complied with:
 - (i) the approach is flown using an approved vertical flight path guidance mode;
 - (ii) the approach segment from final approach fix (FAF) to runway threshold is straight and the difference between the final approach course and the runway centreline is not greater than 2°;
 - (iii) the final approach path is published and not greater than 3,7°;
 - (iv) the maximum cross-wind components established during certification of the EVS are not exceeded.

GM1 SPA.LVO.110(c)(4)(i) General operating requirements**APPROVED VERTICAL FLIGHT PATH GUIDANCE MODE**

The term 'approved' means that the vertical flight path guidance mode has been certified by the Agency as part of the avionics product.

SPA.LVO.115 Aerodrome related requirements

- (a) The operator shall not use an aerodrome for LVOs below a visibility of 800 m unless:
- (1) the aerodrome has been approved for such operations by the State of the aerodrome; and
 - (2) low visibility procedures (LVP) have been established.
- (b) If the operator selects an aerodrome where the term LVP is not used, the operator shall ensure that there are equivalent procedures that adhere to the requirements of LVP at the aerodrome. This situation shall be clearly noted in the operations manual or procedures manual including guidance to the flight crew on how to determine that the equivalent LVP are in effect.

SPA.LVO.120 Flight crew training and qualifications

The operator shall ensure that, prior to conducting an LVO:

- (a) each flight crew member:
- (1) complies with the training and checking requirements prescribed in the operations manual, including flight simulation training device (FSTD) training, in operating to the limiting values of RVR/VIS (visibility) and DH specific to the operation and the aircraft type;
 - (2) is qualified in accordance with the standards prescribed in the operations manual;
- (b) the training and checking is conducted in accordance with a detailed syllabus.

AMC1 SPA.LVO.120 Flight crew training and qualifications**GENERAL PROVISIONS**

- (a) The operator should ensure that flight crew member training programmes for LVO include structured courses of ground, FSTD and/or flight training.
- (1) Flight crew members with no CAT II or CAT III experience should complete the full training programme prescribed in (b), (c), and (d) below.
 - (2) Flight crew members with CAT II or CAT III experience with a similar type of operation (auto-coupled/auto-land, HUDLS/hybrid HUDLS or EVS) or CAT II with manual land, if appropriate, with another EU operator may undertake an:
 - (i) abbreviated ground training course if operating a different type or class from that on which the previous CAT II or CAT III experience was gained;
 - (ii) abbreviated ground, FSTD and/or flight training course if operating the same type or class and variant of the same type or class on which the previous CAT II or CAT III experience was gained. The abbreviated course should include at least the provisions of (d)(1), (d)(2)(i) or (d)(2)(ii) as appropriate and (d)(3)(i). The operator may reduce the number of approaches/landings required by (d)(2)(i) if the type/class or the variant of the type or class has the same or similar:
 - (A) level of technology - flight control/guidance system (FGS);
 - (B) operating procedures;
 - (C) handling characteristics;
 - (D) use of HUDLS/hybrid HUDLS; and
 - (E) use of EVS,

- as the previously operated type or class, otherwise the provisions of (d)(2)(i) should be met.
- (3) Flight crew members with CAT II or CAT III experience with the operator may undertake an abbreviated ground, FSTD and/or flight training course.
- (i) When changing aircraft type or class, the abbreviated course should include at least the provisions of (d)(1), (d)(2)(i) or (d)(2)(ii) as appropriate and (d)(3)(i).
- (ii) When changing to a different variant of aircraft within the same type or class rating that has the same or similar:
- (A) level of technology - FGS;
- (B) operating procedures - integrity;
- (C) handling characteristics;
- (D) use of HUDLS/Hybrid HUDLS; and
- (E) use of EVS,
- as the previously operated type or class, a difference course or familiarisation appropriate to the change of variant should fulfil the abbreviated course provisions.
- (iii) When changing to a different variant of aircraft within the same type or class rating that has a significantly different:
- (A) level of technology - FGS;
- (B) operating procedures - integrity;
- (C) handling characteristics;
- (D) use of HUDLS/Hybrid HUDLS; or
- (E) use of EVS,
- the provisions of (d)(1), (d)(2)(i) or (d)(2)(ii) as appropriate and (d)(3)(i) should be fulfilled.
- (4) The operator should ensure when undertaking CAT II or CAT III operations with different variant(s) of aircraft within the same type or class rating that the differences and/or similarities of the aircraft concerned justify such operations, taking into account at least the following:
- (i) the level of technology, including the:
- (A) FGS and associated displays and controls;
- (B) FMS and its integration or not with the FGS; and
- (C) use of HUD/HUDLS with hybrid systems and/or EVS;
- (ii) operating procedures, including:
- (A) fail-passive / fail-operational, alert height;
- (B) manual landing / automatic landing;
- (C) no DH operations; and
- (D) use of HUD/HUDLS with hybrid systems;
- (iii) handling characteristics, including:

- (A) manual landing from automatic HUDLS and/or EVS guided approach;
- (B) manual missed approach procedure from automatic approach; and
- (C) automatic/manual rollout.

GROUND TRAINING

- (b) The initial ground training course for LVO should include at least the following:
 - (1) characteristics and limitations of the ILS and/or MLS;
 - (2) characteristics of the visual aids;
 - (3) characteristics of fog;
 - (4) operational capabilities and limitations of the particular airborne system to include HUD symbology and EVS characteristics, if appropriate;
 - (5) effects of precipitation, ice accretion, low level wind shear and turbulence;
 - (6) effect of specific aircraft/system malfunctions;
 - (7) use and limitations of RVR assessment systems;
 - (8) principles of obstacle clearance requirements;
 - (9) recognition of and action to be taken in the event of failure of ground equipment;
 - (10) procedures and precautions to be followed with regard to surface movement during operations when the RVR is 400 m or less and any additional procedures required for take-off in conditions below 150 m (200 m for category D aeroplanes);
 - (11) significance of DHs based upon radio altimeters and the effect of terrain profile in the approach area on radio altimeter readings and on the automatic approach/landing systems;
 - (12) importance and significance of alert height, if applicable, and the action in the event of any failure above and below the alert height;
 - (13) qualification requirements for pilots to obtain and retain approval to conduct LVOs; and
 - (14) importance of correct seating and eye position.

FSTD TRAINING AND/OR FLIGHT TRAINING

- (c) FSTD training and/or flight training
 - (1) FSTD and/or flight training for LVO should include at least:
 - (i) checks of satisfactory functioning of equipment, both on the ground and in flight;
 - (ii) effect on minima caused by changes in the status of ground installations;
 - (iii) monitoring of:
 - (A) automatic flight control systems and auto-land status annunciators with emphasis on the action to be taken in the event of failures of such systems; and
 - (B) HUD/HUDLS/EVS guidance status and annunciators as appropriate, to include head-down displays;
 - (iv) actions to be taken in the event of failures such as engines, electrical systems, hydraulics or flight control systems;

- (v) the effect of known unserviceabilities and use of MELs;
 - (vi) operating limitations resulting from airworthiness certification;
 - (vii) guidance on the visual cues required at DH together with information on maximum deviation allowed from glide path or localiser; and
 - (viii) the importance and significance of alert height if applicable and the action in the event of any failure above and below the alert height.
- (2) Flight crew members should be trained to carry out their duties and instructed on the coordination required with other crew members. Maximum use should be made of suitably equipped FSTDs for this purpose.
- (3) Training should be divided into phases covering normal operation with no aircraft or equipment failures but including all weather conditions that may be encountered and detailed scenarios of aircraft and equipment failure that could affect CAT II or III operations. If the aircraft system involves the use of hybrid or other special systems, such as HUD/HUDLS or enhanced vision equipment, then flight crew members should practise the use of these systems in normal and abnormal modes during the FSTD phase of training.
- (4) Incapacitation procedures appropriate to LVTO, CAT II and CAT III operations should be practised.
- (5) For aircraft with no FSTD available to represent that specific aircraft, operators should ensure that the flight training phase specific to the visual scenarios of CAT II operations is conducted in a specifically approved FSTD. Such training should include a minimum of four approaches. Thereafter, the training and procedures that are type specific should be practised in the aircraft.
- (6) Initial CAT II and III training should include at least the following exercises:
- (i) approach using the appropriate flight guidance, autopilots and control systems installed in the aircraft, to the appropriate DH and to include transition to visual flight and landing;
 - (ii) approach with all engines operating using the appropriate flight guidance systems, autopilots, HUDLS and/or EVS and control systems installed in the aircraft down to the appropriate DH followed by missed approach - all without external visual reference;
 - (iii) where appropriate, approaches utilising automatic flight systems to provide automatic flare, hover, landing and rollout; and
 - (iv) normal operation of the applicable system both with and without acquisition of visual cues at DH.
- (7) Subsequent phases of training should include at least:
- (i) approaches with engine failure at various stages on the approach;
 - (ii) approaches with critical equipment failures, such as electrical systems, auto flight systems, ground and/or airborne ILS, MLS systems and status monitors;
 - (iii) approaches where failures of auto flight equipment and/or HUD/HUDLS/EVS at low level require either:
 - (A) reversion to manual flight to control flare, hover, landing and rollout or missed approach; or

- (B) reversion to manual flight or a downgraded automatic mode to control missed approaches from, at or below DH including those which may result in a touchdown on the runway;
 - (iv) failures of the systems that will result in excessive localiser and/or glideslope deviation, both above and below DH, in the minimum visual conditions specified for the operation. In addition, a continuation to a manual landing should be practised if a head-up display forms a downgraded mode of the automatic system or the head-up display forms the only flare mode; and
 - (v) failures and procedures specific to aircraft type or variant.
- (8) The training programme should provide practice in handling faults which require a reversion to higher minima.
 - (9) The training programme should include the handling of the aircraft when, during a fail-passive CAT III approach, the fault causes the autopilot to disconnect at or below DH when the last reported RVR is 300 m or less.
 - (10) Where take-offs are conducted in RVRs of 400 m and below, training should be established to cover systems failures and engine failure resulting in continued as well as rejected take-offs.
 - (11) The training programme should include, where appropriate, approaches where failures of the HUDLS and/or EVS equipment at low level require either:
 - (i) reversion to head down displays to control missed approach; or
 - (ii) reversion to flight with no, or downgraded, HUDLS guidance to control missed approaches from DH or below, including those which may result in a touchdown on the runway.
 - (12) When undertaking LVTO, LTS CAT I, OTS CAT II, CAT II and CAT III operations utilising a HUD/HUDLS, hybrid HUD/HUDLS or an EVS, the training and checking programme should include, where appropriate, the use of the HUD/HUDLS in normal operations during all phases of flight.

CONVERSION TRAINING

- (d) Flight crew members should complete the following low visibility procedures (LVPs) training if converting to a new type or class or variant of aircraft in which LVTO, LTS CAT I, OTS CAT II, approach operations utilising EVS with an RVR of 800 m or less and CAT II and CAT III operations will be conducted. Conditions for abbreviated courses are prescribed in (a)(2), (a)(3) and (a)(4).
 - (1) Ground training

The appropriate provisions are as prescribed in (b), taking into account the flight crew member's CAT II and CAT III training and experience.
 - (2) FSTD training and/or flight training
 - (i) A minimum of six, respectively eight for HUDLS with or without EVS, approaches and/or landings in an FSTD. The provisions for eight HUDLS approaches may be reduced to six when conducting hybrid HUDLS operations.
 - (ii) Where no FSTD is available to represent that specific aircraft, a minimum of three, respectively five for HUDLS and/or EVS, approaches including at least one missed approach procedure is required on the aircraft. For hybrid HUDLS operations a

minimum of three approaches is required, including at least one missed approach procedure.

- (iii) Appropriate additional training if any special equipment is required such as head-up displays or enhanced vision equipment. When approach operations utilising EVS are conducted with an RVR of less than 800 m, a minimum of five approaches, including at least one missed approach procedure are required on the aircraft.

(3) Flight crew qualification

The flight crew qualification provisions are specific to the operator and the type of aircraft operated.

- (i) The operator should ensure that each flight crew member completes a check before conducting CAT II or III operations.
- (ii) The check specified in (d)(3)(i) may be replaced by successful completion of the FSTD and/or flight training specified in (d)(2).

(4) Line flying under supervision

Flight crew member should undergo the following line flying under supervision (LIFUS):

- (i) For CAT II when a manual landing or a HUDLS approach to touchdown is required, a minimum of:
 - (A) three landings from autopilot disconnect; and
 - (B) four landings with HUDLS used to touchdown,except that only one manual landing, respectively two using HUDLS, to touchdown is required when the training required in (d)(2) has been carried out in an FSTD qualified for zero flight time conversion.
- (ii) For CAT III, a minimum of two auto-lands, except that:
 - (A) only one auto-land is required when the training required in (d)(2) has been carried out in an FSTD qualified for zero flight time conversion;
 - (B) no auto-land is required during LIFUS when the training required in (d)(2) has been carried out in an FSTD qualified for zero flight time (ZFT) conversion and the flight crew member successfully completed the ZFT type rating conversion course; and
 - (C) the flight crew member, trained and qualified in accordance with (B), is qualified to operate during the conduct of LIFUS to the lowest approved DA/H and RVR as stipulated in the operations manual.
- (iii) For CAT III approaches using HUDLS to touchdown, a minimum of four approaches.

TYPE AND COMMAND EXPERIENCE

(e) Type and command experience

- (1) Before commencing CAT II operations, the following additional provisions should be applicable to pilots-in-command/commanders, or pilots to whom conduct of the flight may be delegated, who are new to the aircraft type or class:
 - (i) 50 hours or 20 sectors on the type, including LIFUS; and

- (ii) 100 m should be added to the applicable CAT II RVR minima when the operation requires a CAT II manual landing or use of HUDLS to touchdown until:
 - (A) a total of 100 hours or 40 sectors, including LIFUS, has been achieved on the type; or
 - (B) a total of 50 hours or 20 sectors, including LIFUS, has been achieved on the type where the flight crew member has been previously qualified for CAT II manual landing operations with an EU operator;
 - (C) for HUDLS operations the sector provisions in (e)(1) and (e)(2)(i) should always be applicable; the hours on type or class do not fulfil the provisions.
- (2) Before commencing CAT III operations, the following additional provisions should be applicable to pilots-in-command/commanders, or pilots to whom conduct of the flight may be delegated, who are new to the aircraft type:
 - (i) 50 hours or 20 sectors on the type, including LIFUS; and
 - (ii) 100 m should be added to the applicable CAT II or CAT III RVR minima unless he/she has previously qualified for CAT II or III operations with an EU operator, until a total of 100 hours or 40 sectors, including LIFUS, has been achieved on the type.

RECURRENT TRAINING AND CHECKING

(f) Recurrent training and checking – LVO

- (1) The operator should ensure that, in conjunction with the normal recurrent training and operator's proficiency checks, the pilot's knowledge and ability to perform the tasks associated with the particular category of operation, for which the pilot is authorised by the operator, are checked. The required number of approaches to be undertaken in the FSTD within the validity period of the operator's proficiency check should be a minimum of two, respectively four when HUDLS and/or EVS is utilised to touchdown, one of which should be a landing at the lowest approved RVR. In addition one, respectively two for HUDLS and/or operations utilising EVS, of these approaches may be substituted by an approach and landing in the aircraft using approved CAT II and CAT III procedures. One missed approach should be flown during the conduct of an operator proficiency check. If the operator is approved to conduct take-off with RVR less than 150 m, at least one LVTO to the lowest applicable minima should be flown during the conduct of the operator's proficiency check.
- (2) For CAT III operations the operator should use an FSTD approved for this purpose.
- (3) For CAT III operations on aircraft with a fail-passive flight control system, including HUDLS, a missed approach should be completed by each flight crew member at least once over the period of three consecutive operator proficiency checks as the result of an autopilot failure at or below DH when the last reported RVR was 300 m or less.

LVTO OPERATIONS

(g) LVTO with RVR less than 400 m

- (1) Prior to conducting take-offs in RVRs below 400 m, the flight crew should undergo the following training:
 - (i) normal take-off in minimum approved RVR conditions;
 - (ii) take-off in minimum approved RVR conditions with an engine failure:

- (A) for aeroplanes between V_1 and V_2 (take-off safety speed), or as soon as safety considerations permit;
- (B) for helicopters at or after take-off decision point (TDP); and
- (iii) take-off in minimum approved RVR conditions with an engine failure:
 - (A) for aeroplanes before V_1 resulting in a rejected take-off; and
 - (B) for helicopters before the TDP.
- (2) The operator approved for LVTOs with an RVR below 150 m should ensure that the training specified by (g)(1) is carried out in an FSTD. This training should include the use of any special procedures and equipment.
- (3) The operator should ensure that a flight crew member has completed a check before conducting LVTO in RVRs of less than 150 m. The check may be replaced by successful completion of the FSTD and/or flight training prescribed in (g)(1) on conversion to an aircraft type.

LTS CAT I, OTS CAT II, OPERATIONS UTILISING EVS

(h) Additional training provisions

(1) General

Operators conducting LTS CAT I operations, OTS CAT II operations and operations utilising EVS with RVR of 800 m or less should comply with the provisions applicable to CAT II operations and include the provisions applicable to HUDLS, if appropriate. The operator may combine these additional provisions where appropriate provided that the operational procedures are compatible.

(2) LTS CAT I

During conversion training the total number of approaches should not be additional to the requirements of Subpart FC of Annex III (ORO.FC) provided the training is conducted utilising the lowest applicable RVR. During recurrent training and checking the operator may also combine the separate requirements provided the above operational procedure provision is met and at least one approach using LTS CAT I minima is conducted at least once every 18 months.

(3) OTS CAT II

During conversion training the total number of approaches should not be less than those to complete CAT II training utilising a HUD/HUDLS. During recurrent training and checking the operator may also combine the separate provisions provided the above operational procedure provision is met and at least one approach using OTS CAT II minima is conducted at least once every 18 months.

(4) Operations utilising EVS with RVR of 800 m or less

During conversion training the total number of approaches required should not be less than that required to complete CAT II training utilising a HUD. During recurrent training and checking the operator may also combine the separate provisions provided the above operational procedure provision is met and at least one approach utilising EVS is conducted at least once every 12 months.

GM1 SPA.LVO.120 Flight crew training and qualifications

FLIGHT CREW TRAINING

The number of approaches referred to in AMC1 SPA.LVO.120 (f)(1) includes one approach and landing that may be conducted in the aircraft using approved CAT II/III procedures. This approach and landing may be conducted in normal line operation or as a training flight.

SPA.LVO.125 Operating procedures

- (a) The operator shall establish procedures and instructions to be used for LVOs. These procedures and instructions shall be included in the operations manual or procedures manual and contain the duties of flight crew members during taxiing, take-off, approach, flare, landing, rollout and missed approach operations, as appropriate.
- (b) Prior to commencing an LVO, the pilot-in-command/commander shall be satisfied that:
 - (1) the status of the visual and non-visual facilities is sufficient;
 - (2) appropriate LVPs are in force according to information received from air traffic services (ATS);
 - (3) flight crew members are properly qualified.

AMC1 SPA.LVO.125 Operating procedures

GENERAL

- (a) LVOs should include the following:
 - (1) manual take-off, with or without electronic guidance systems or HUDLS/hybrid HUD/HUDLS;
 - (2) approach flown with the use of a HUDLS/hybrid HUD/HUDLS and/or EVS;
 - (3) auto-coupled approach to below DH, with manual flare, hover, landing and rollout;
 - (4) auto-coupled approach followed by auto-flare, hover, auto-landing and manual rollout; and
 - (5) auto-coupled approach followed by auto-flare, hover, auto-landing and auto-rollout, when the applicable RVR is less than 400 m.

PROCEDURES AND INSTRUCTIONS

- (b) The operator should specify detailed operating procedures and instructions in the operations manual or procedures manual.
 - (1) The precise nature and scope of procedures and instructions given should depend upon the airborne equipment used and the flight deck procedures followed. The operator should clearly define flight crew member duties during take-off, approach, flare, hover, rollout and missed approach in the operations manual or procedures manual. Particular emphasis should be placed on flight crew responsibilities during transition from non-visual conditions to visual conditions, and on the procedures to be used in deteriorating visibility or when failures occur. Special attention should be paid to the distribution of flight deck duties so as to ensure that the workload of the pilot making the decision to land or execute a missed approach enables him/her to devote himself/herself to supervision and the decision making process.
 - (2) The instructions should be compatible with the limitations and mandatory procedures contained in the AFM and cover the following items in particular:
 - (i) checks for the satisfactory functioning of the aircraft equipment, both before departure and in flight;
 - (ii) effect on minima caused by changes in the status of the ground installations and airborne equipment;

-
- (iii) procedures for the take-off, approach, flare, hover, landing, rollout and missed approach;
 - (iv) procedures to be followed in the event of failures, warnings to include HUD/HUDLS/EVS and other non-normal situations;
 - (v) the minimum visual reference required;
 - (vi) the importance of correct seating and eye position;
 - (vii) action that may be necessary arising from a deterioration of the visual reference;
 - (viii) allocation of crew duties in the carrying out of the procedures according to (b)(2)(i) to (iv) and (vi), to allow the pilot-in-command/commander to devote himself/herself mainly to supervision and decision making;
 - (ix) the rule for all height calls below 200 ft to be based on the radio altimeter and for one pilot to continue to monitor the aircraft instruments until the landing is completed;
 - (x) the rule for the localiser sensitive area to be protected;
 - (xi) the use of information relating to wind velocity, wind shear, turbulence, runway contamination and use of multiple RVR assessments;
 - (xii) procedures to be used for:
 - (A) LTS CAT I;
 - (B) OTS CAT II;
 - (C) approach operations utilising EVS; and
 - (D) practice approaches and landing on runways at which the full CAT II or CAT III aerodrome procedures are not in force;
 - (xiii) operating limitations resulting from airworthiness certification; and
 - (xiv) information on the maximum deviation allowed from the ILS glide path and/or localiser.

SPA.LVO.130 Minimum equipment

- (a) The operator shall include the minimum equipment that has to be serviceable at the commencement of an LVO in accordance with the aircraft flight manual (AFM) or other approved document in the operations manual or procedures manual, as applicable.
- (b) The pilot-in-command/commander shall be satisfied that the status of the aircraft and of the relevant airborne systems is appropriate for the specific operation to be conducted.

SUBPART F: EXTENDED RANGE OPERATIONS WITH TWO-ENGINE AEROPLANES (ETOPS)

SPA.ETOPS.100 ETOPS

In commercial air transport operations, two-engined aeroplanes shall only be operated beyond the threshold distance determined in accordance with CAT.OP.MPA.140 if the operator has been granted an ETOPS operational approval by the competent authority.

SPA.ETOPS.105 ETOPS operational approval

To obtain an ETOPS operational approval from the competent authority, the operator shall provide evidence that:

- (a) the aeroplane/engine combination holds an ETOPS type design and reliability approval for the intended operation;
- (b) a training programme for the flight crew members and all other operations personnel involved in these operations has been established and the flight crew members and all other operations personnel involved are suitably qualified to conduct the intended operation;
- (c) the operator's organisation and experience are appropriate to support the intended operation;
- (d) operating procedures have been established.

GM1 SPA.ETOPS.105 ETOPS operational approval

AMC 20-6

AMC 20-6 provides further criteria for the operational approval of ETOPS.

SPA.ETOPS.110 ETOPS en-route alternate aerodrome

- (a) An ETOPS en-route alternate aerodrome shall be considered adequate, if, at the expected time of use, the aerodrome is available and equipped with necessary ancillary services such as air traffic services (ATS), sufficient lighting, communications, weather reporting, navigation aids and emergency services and has at least one instrument approach procedure available.
- (b) Prior to conducting an ETOPS flight, the operator shall ensure that an ETOPS en-route alternate aerodrome is available, within either the operator's approved diversion time, or a diversion time based on the MEL generated serviceability status of the aeroplane, whichever is shorter.
- (c) The operator shall specify any required ETOPS en-route alternate aerodrome(s) in the operational flight plan and ATS flight plan.

SPA.ETOPS.115 ETOPS en-route alternate aerodrome planning minima

- (a) The operator shall only select an aerodrome as an ETOPS en-route alternate aerodrome when the appropriate weather reports or forecasts, or any combination thereof, indicate that, between the anticipated time of landing until one hour after the latest possible time of landing, conditions will exist at or above the planning minima calculated by adding the additional limits of Table 1.
- (b) The operator shall include in the operations manual the method for determining the operating minima at the planned ETOPS en-route alternate aerodrome.

Table 1**Planning minima for the ETOPS en-route alternate aerodrome**

Type of approach	Planning minima
Precision approach	DA/H + 200 ft RVR/VIS + 800 m ⁽¹⁾
Non-precision approach or Circling approach	MDA/H + 400 ft ⁽¹⁾ RVR/VIS + 1500 m
(1) VIS: visibility; MDA/H: minimum descent altitude/height.	

SUBPART G: TRANSPORT OF DANGEROUS GOODS

SPA.DG.100 Transport of dangerous goods

Except as provided for in Annex IV (Part-CAT), Annex VI (Part-NCC), Annex VII (Part-NCO) and Annex VIII (Part-SPO), the operator shall only transport dangerous goods by air if the operator has been approved by the competent authority.

SPA.DG.105 Approval to transport dangerous goods

To obtain the approval to transport dangerous goods, the operator shall in accordance with the technical instructions:

- (a) establish and maintain a training programme for all personnel involved and demonstrate to the competent authority that adequate training has been given to all personnel;
- (b) establish operating procedures to ensure the safe handling of dangerous goods at all stages of air transport, containing information and instructions on:
 - (1) the operator's policy to transport dangerous goods;
 - (2) the requirements for acceptance, handling, loading, stowage and segregation of dangerous goods;
 - (3) actions to take in the event of an aircraft accident or incident when dangerous goods are being carried;
 - (4) the response to emergency situations involving dangerous goods;
 - (5) the removal of any possible contamination;
 - (6) the duties of all personnel involved, especially with relevance to ground handling and aircraft handling;
 - (7) inspection for damage, leakage or contamination;
 - (8) dangerous goods accident and incident reporting.

AMC1 SPA.DG.105(a) Approval to transport dangerous goods

TRAINING PROGRAMME

- (a) The operator should indicate for the approval of the training programme how the training will be carried out. For formal training courses, the course objectives, the training programme syllabus/curricula and examples of the written examination to be undertaken should be included.
- (b) Instructors should have knowledge of training techniques as well as in the field of transport of dangerous goods by air so that the subject is covered fully and questions can be adequately answered.
- (c) Training intended to give general information and guidance may be by any means including handouts, leaflets, circulars, slide presentations, videos, computer-based training, etc., and may take place on-the-job or off-the-job. The person being trained should receive an overall awareness of the subject. This training should include a written, oral or computer-based examination

- covering all areas of the training programme, showing that a required minimum level of knowledge has been acquired.
- (d) Training intended to give an in-depth and detailed appreciation of the whole subject or particular aspects of it should be by formal training courses, which should include a written examination, the successful passing of which will result in the issue of the proof of qualification. The course may be by means of tuition, as a self-study programme, or a mixture of both. The person being trained should gain sufficient knowledge so as to be able to apply the detailed rules of the Technical Instructions.
- (e) Training in emergency procedures should include as a minimum:
- (1) for personnel other than crew members:
 - (i) dealing with damaged or leaking packages; and
 - (ii) other actions in the event of ground emergencies arising from dangerous goods;
 - (2) for flight crew members:
 - (i) actions in the event of emergencies in flight occurring in the passenger compartment or in the cargo compartments; and
 - (ii) the notification to ATS should an in-flight emergency occur;
 - (3) for crew members other than flight crew members:
 - (i) dealing with incidents arising from dangerous goods carried by passengers; or
 - (ii) dealing with damaged or leaking packages in flight.
- (f) Training should be conducted at intervals of no longer than 2 years.

AMC1 SPA.DG.105(b) Approval to transport dangerous goods

PROVISION OF INFORMATION IN THE EVENT OF AN IN-FLIGHT EMERGENCY

If an in-flight emergency occurs the pilot-in-command/commander should, as soon as the situation permits, inform the appropriate ATS unit of any dangerous goods carried as cargo on board the aircraft, as specified in the Technical Instructions.

GM1 SPA.DG.105(b)(6) Approval to transport dangerous goods

PERSONNEL

Personnel include all persons involved in the transport of dangerous goods, whether they are employees of the operator or not.

SPA.DG.110 Dangerous goods information and documentation

The operator shall, in accordance with the technical instructions:

- (a) provide written information to the pilot-in-command/commander:
 - (1) about dangerous goods to be carried on the aircraft;
 - (2) for use in responding to in-flight emergencies;
- (b) use an acceptance checklist;
- (c) ensure that dangerous goods are accompanied by the required dangerous goods transport document(s), as completed by the person offering dangerous goods for air transport, except when the information applicable to the dangerous goods is provided in electronic form;
- (d) ensure that where a dangerous goods transport document is provided in written form, a copy of the document is retained on the ground where it will be possible to obtain access to it within a reasonable period until the goods have reached their final destination;
- (e) ensure that a copy of the information to the pilot-in-command/commander is retained on the ground and that this copy, or the information contained in it, is readily accessible to the aerodromes of last departure and next scheduled arrival, until after the flight to which the information refers;
- (f) retain the acceptance checklist, transport document and information to the pilot-in-command/commander for at least three months after completion of the flight;
- (g) retain the training records of all personnel for at least three years.

AMC1 SPA.DG.110(a) Dangerous goods information and documentation

INFORMATION TO THE PILOT-IN-COMMAND/COMMANDER

If the volume of information provided to the pilot-in-command/commander by the operator is such that it would be impracticable to transmit it in the event of an in-flight emergency, an additional summary of the information should also be provided, containing at least the quantities and class or division of the dangerous goods in each cargo compartment.

AMC1 SPA.DG.110(b) Dangerous goods information and documentation

ACCEPTANCE OF DANGEROUS GOODS

- (a) The operator should not accept dangerous goods unless:
 - (1) the package, overpack or freight container has been inspected in accordance with the acceptance procedures in the Technical Instructions;
 - (2) they are accompanied by two copies of a dangerous goods transport document or the information applicable to the consignment is provided in electronic form, except when otherwise specified in the Technical Instructions; and
 - (3) the English language is used for:
 - (i) package marking and labelling; and
 - (ii) the dangerous goods transport document,in addition to any other language provision.

-
- (b) The operator or his/her handling agent should use an acceptance checklist which allows for:
- (1) all relevant details to be checked; and
 - (2) the recording of the results of the acceptance check by manual, mechanical or computerised means.

SUBPART H: HELICOPTER OPERATIONS WITH NIGHT VISION IMAGING SYSTEMS

SPA.NVIS.100 Night vision imaging system (NVIS) operations

- (a) Helicopters shall only be operated under VFR at night with the aid of NVIS if the operator has been approved by the competent authority.
- (b) To obtain such approval by the competent authority, the operator shall:
 - (1) operate in commercial air transport (CAT) and hold a CAT AOC in accordance with Annex III (Part-ORO);
 - (2) demonstrate to the competent authority:
 - (i) compliance with the applicable requirements contained in this Subpart;
 - (ii) the successful integration of all elements of the NVIS.

SPA.NVIS.110 Equipment requirements for NVIS operations

- (a) Before conducting NVIS operations each helicopter and all associated NVIS equipment shall have been issued with the relevant airworthiness approval in accordance with Regulation (EU) No 748/2012.
- (b) *Radio altimeter.* The helicopter shall be equipped with a radio altimeter capable of emitting an audio warning below a pre-set height and an audio and visual warning at a height selectable by the pilot, instantly discernable during all phases of NVIS flight.
- (c) *Aircraft NVIS compatible lighting.* To mitigate the reduced peripheral vision cues and the need to enhance situational awareness, the following shall be provided:
 - (1) NVIS-compatible instrument panel flood-lighting, if installed, that can illuminate all essential flight instruments;
 - (2) NVIS-compatible utility lights;
 - (3) portable NVIS compatible flashlight; and
 - (4) a means for removing or extinguishing internal NVIS non-compatible lights.
- (d) *Additional NVIS equipment.* The following additional NVIS equipment shall be provided:
 - (1) a back-up or secondary power source for the night vision goggles (NVG);
 - (2) a helmet with the appropriate NVG attachment.
- (e) All required NVGs on an NVIS flight shall be of the same type, generation and model.
- (f) Continuing airworthiness
 - (1) Procedures for continuing airworthiness shall contain the information necessary for carrying out ongoing maintenance and inspections on NVIS equipment installed in the helicopter and shall cover, as a minimum:
 - (i) helicopter windscreens and transparencies;
 - (ii) NVIS lighting;
 - (iii) NVGs; and
 - (iv) any additional equipment that supports NVIS operations.

- (2) Any subsequent modification or maintenance to the aircraft shall be in compliance with the NVIS airworthiness approval.

AMC1 SPA.NVIS.110(b) Equipment requirements for NVIS operations

RADIO ALTIMETER

- (a) The radio altimeter should:
 - (1) be of an analogue type display presentation that requires minimal interpretation for both an instantaneous impression of absolute height and rate of change of height;
 - (2) be positioned to be instantly visible and discernable from each cockpit crew station;
 - (3) have an integral audio and visual low height warning that operates at a height selectable by the pilot; and
 - (4) provide unambiguous warning to the crew of radio altimeter failure.
- (b) The visual warning should provide:
 - (1) clear visual warning at each cockpit crew station of height below the pilot-selectable height; and
 - (2) adequate attention-getting-capability for typical NVIS operations.
- (c) The audio warning should:
 - (1) be unambiguous and readily cancellable;
 - (2) not extinguish any visual low height warnings when cancelled; and
 - (3) operate at the same pilot-selectable height as the visual warning.

GM1 SPA.NVIS.110(b) Equipment requirements for NVIS operations

RADIO ALTIMETER

An analogue type display presentation may be, for example, a representation of a dial, ribbon or bar, but not a display that provides numbers only. An analogue type display may be embedded into an electronic flight instrumentation system (EFIS).

GM1 SPA.NVIS.110(f) Equipment requirements for NVIS operations

MODIFICATION OR MAINTENANCE TO THE HELICOPTER

It is important that the operator reviews and considers all modifications or maintenance to the helicopter with regard to the NVIS airworthiness approval. Special emphasis needs to be paid to modification and maintenance of equipment such as light emitting or reflecting devices, transparencies and avionics equipment, as the function of this equipment may interfere with the NVGs.

SPA.NVIS.120 NVIS operating minima

- (a) Operations shall not be conducted below the VFR weather minima for the type of night operations being conducted.
- (b) The operator shall establish the minimum transition height from where a change to/from aided flight may be continued.

SPA.NVIS.130 Crew requirements for NVIS operations

- (a) *Selection.* The operator shall establish criteria for the selection of crew members for the NVIS task.
- (b) *Experience.* The minimum experience for the commander shall not be less than 20 hours VFR at night as pilot-in-command/commander of a helicopter before commencing training.
- (c) *Operational training.* All pilots shall have completed the operational training in accordance with the NVIS procedures contained in the operations manual.
- (d) *Recency.* All pilots and NVIS technical crew members conducting NVIS operations shall have completed three NVIS flights in the last 90 days. Recency may be re-established on a training flight in the helicopter or an approved full flight simulator (FFS), which shall include the elements of (f)(1).
- (e) *Crew composition.* The minimum crew shall be the greater of that specified:
 - (1) in the aircraft flight manual (AFM);
 - (2) for the underlying activity; or
 - (3) in the operational approval for the NVIS operations.
- (f) *Crew training and checking*
 - (1) Training and checking shall be conducted in accordance with a detailed syllabus approved by the competent authority and included in the operations manual.
 - (2) *Crew members*
 - (i) Crew training programmes shall: improve knowledge of the NVIS working environment and equipment; improve crew coordination; and include measures to minimise the risks associated with entry into low visibility conditions and NVIS normal and emergency procedures.
 - (ii) The measures referred to in (f)(2)(i) shall be assessed during:
 - (A) night proficiency checks; and
 - (B) line checks.

GM1 SPA.NVIS.130(e) Crew requirements for NVIS operations

UNDERLYING ACTIVITY

Examples of an underlying activity are:

- (a) commercial air transport (CAT);
- (b) helicopter emergency medical service (HEMS); and
- (c) helicopter hoist operation (HHO).

GM2 SPA.NVIS.130(e) Crew requirements for NVIS operations

OPERATIONAL APPROVAL

- (a) When determining the composition of the minimum crew, the competent authority should take account of the type of operation that is to be conducted. The minimum crew should be part of the operational approval.
- (b) If the operational use of NVIS is limited to the en-route phase of a CAT flight, a single-pilot operation may be approved.
- (c) Where operations to/from a HEMS operating site are to be conducted, a crew of at least one pilot and one NVIS technical crew member would be necessary (this may be the suitably qualified HEMS technical crew member).
- (d) A similar assessment may be made for night HHO, when operating to unprepared sites.

AMC1 SPA.NVIS.130(f)(1) Crew requirements for NVIS operations

TRAINING AND CHECKING SYLLABUS

- (a) The flight crew training syllabus should include the following items:
 - (1) NVIS working principles, eye physiology, vision at night, limitations and techniques to overcome these limitations;
 - (2) preparation and testing of NVIS equipment;
 - (3) preparation of the helicopter for NVIS operations;
 - (4) normal and emergency procedures including all NVIS failure modes;
 - (5) maintenance of unaided night flying;
 - (6) crew coordination concept specific to NVIS operations;
 - (7) practice of the transition to and from NVG procedures;
 - (8) awareness of specific dangers relating to the operating environment; and
 - (9) risk analysis, mitigation and management.
- (b) The flight crew checking syllabus should include:
 - (1) night proficiency checks, including emergency procedures to be used on NVIS operations; and
 - (2) line checks with special emphasis on the following:
 - (i) local area meteorology;
 - (ii) NVIS flight planning;
 - (iii) NVIS in-flight procedures;
 - (iv) transitions to and from night vision goggles (NVG);
 - (v) normal NVIS procedures; and
 - (vi) crew coordination specific to NVIS operations.
- (c) Whenever the crew is required to also consist of an NVIS technical crew member, he/she should be trained and checked in the following items:
 - (1) NVIS working principles, eye physiology, vision at night, limitations, and techniques to overcome these limitations;

- (2) duties in the NVIS role, with and without NVGs;
- (3) the NVIS installation;
- (4) operation and use of the NVIS equipment;
- (5) preparing the helicopter and specialist equipment for NVIS operations;
- (6) normal and emergency procedures;
- (7) crew coordination concepts specific to NVIS operations;
- (8) awareness of specific dangers relating to the operating environment; and
- (9) risk analysis, mitigation and management.

AMC1 SPA.NVIS.130(f) Crew requirements

CHECKING OF NVIS CREW MEMBERS

The checks required in SPA.NVIS.130 (f) may be combined with those checks required for the underlying activity.

GM1 SPA.NVIS.130(f) Crew requirements

TRAINING GUIDELINES AND CONSIDERATIONS

(a) Purpose

The purpose of this GM is to recommend the minimum training guidelines and any associated considerations necessary for the safe operation of a helicopter while operating with night vision imaging systems (NVISs).

To provide an appropriate level of safety, training procedures should accommodate the capabilities and limitations of the NVIS and associated systems as well as the restraints of the operational environment.

(b) Assumptions

The following assumptions were used in the creation of this material:

- (1) Most civilian operators may not have the benefit of formal NVIS training, similar to that offered by the military. Therefore, the stated considerations are predicated on that individual who has no prior knowledge of NVIS or how to use them in flight. The degree to which other applicants who have had previous formal training should be exempted from this training will be dependent on their prior NVIS experience.
- (2) While NVIS are principally an aid to flying under VFR at night, the two-dimensional nature of the NVG image necessitates frequent reference to the flight instruments for spatial and situational awareness information. The reduction of peripheral vision and increased reliance on focal vision exacerbates this requirement to monitor flight instruments. Therefore, any basic NVIS training syllabus should include some instruction on basic instrument flight.

(c) Two-tiered approach: basic and advance training

To be effective, the NVIS training philosophy would be based on a two-tiered approach: basic and advanced NVIS training. The basic NVIS training would serve as the baseline standard for all individuals seeking an NVIS endorsement. The content of this initial training would not be dependent on any operational requirements. The training required for any individual pilot should take into account the previous NVIS flight experience. The advanced training would build on the basic training by focusing on developing specialised skills required to operate a helicopter during NVIS operations in a particular operational environment. Furthermore, while there is a need to

stipulate minimum flight hour requirements for an NVIS endorsement, the training should also be event-based. This necessitates that operators be exposed to all of the relevant aspects, or events, of NVIS flight in addition to acquiring a minimum number of flight hours. NVIS training should include flight in a variety of actual ambient light and weather conditions.

(d) Training requirements

(1) Flight crew ground training

The ground training necessary to initially qualify a pilot to act as the pilot of a helicopter using NVGs should include at least the following subjects:

- (i) applicable aviation regulations that relate to NVIS limitations and flight operations;
- (ii) aero-medical factors relating to the use of NVGs to include how to protect night vision, how the eyes adapt to operate at night, self-imposed stresses that affect night vision, effects of lighting (internal and external) on night vision, cues utilized to estimate distance and depth perception at night, and visual illusions;
- (iii) NVG performance and scene interpretation;
- (iv) normal, abnormal, and emergency operations of NVGs; and
- (v) NVIS operations flight planning to include night terrain interpretation and factors affecting terrain interpretation.

The ground training should be the same for flight crew and crew members other than flight crew. An example of a ground training syllabus is presented in Table 1 of GM2 SPA.NVIS.130(f).

(2) Flight crew flight training

The flight training necessary to initially qualify a pilot to act as the pilot of a helicopter using NVGs may be performed in a helicopter or FSTD approved for the purpose, and should include at least the following subjects:

- (i) preparation and use of internal and external helicopter lighting systems for NVIS operations;
- (ii) pre-flight preparation of NVGs for NVIS operations;
- (iii) proper piloting techniques (during normal, abnormal, and emergency helicopter operations) when using NVGs during the take-off, climb, en-route, descent, and landing phases of flight that includes unaided flight and aided flight; and
- (iv) normal, abnormal, and emergency operations of the NVIS during flight.

Crew members other than flight crew should be involved in relevant parts of the flight training. An example of a flight training syllabus is presented in Table 1 of GM3 SPA.NVIS.130(f).

(3) Training crew members other than flight crew

Crew members other than flight crew (including the technical crew member) should be trained to operate around helicopters employing NVIS. These individuals should complete all phases of NVIS ground training that is given to flight crew. Due to the importance of crew coordination, it is imperative that all crew members are familiar with all aspects of NVIS flight. Furthermore, these crew members may have task qualifications specific to their position in the helicopter or areas of responsibility. To this end, they should demonstrate competency in those areas, both on the ground and in flight.

(4) Ground personnel training

Non-flying personnel who support NVIS operations should also receive adequate training in their areas of expertise. The purpose is to ensure, for example, that correct light discipline is used when helicopters are landing in a remote area.

(5) Instructor qualifications

An NVIS flight instructor should at least have the following licences and qualifications:

- (i) at least flight instructor (FI(H)) or type rating instructor (TRI(H)) with the applicable type rating on which NVIS training will be given; and
- (ii) logged at least 100 NVIS flights or 30 hours' flight time under NVIS as pilot-in-command/commander.

(6) NVIS equipment minimum requirements (training)

While minimum equipment lists and standard NVIS equipment requirements may be stipulated elsewhere, the following procedures and minimum equipment requirements should also be considered:

- (i) NVIS: the following is recommended for minimum NVIS equipment and procedural requirements:

- (A) back-up power supply;
- (B) NVIS adjustment kit or eye lane;
- (C) use of helmet with the appropriate NVG attachment; and
- (D) both the instructor and student should wear the same NVG type, generation and model.

- (ii) Helicopter NVIS compatible lighting, flight instruments and equipment: given the limited peripheral vision cues and the need to enhance situational awareness, the following is recommended for minimum compatible lighting requirements:

- (A) NVIS compatible instrument panel flood lighting that can illuminate all essential flight instruments;
- (B) NVIS compatible hand-held utility lights;
- (C) portable NVIS compatible flashlight;
- (D) a means for removing or extinguishing internal NVIS non-compatible lights;
- (E) NVIS pre-flight briefing/checklist (an example of an NVIS pre-flight briefing/checklist is in Table 1 of GM4-SPA.NVIS.130(f));
- (F) training references:

a number of training references are available, some of which are listed below:

- DO 295 US CONOPS civil operator training guidelines for integrated NVIS equipment
- United States Marine Corp MAWTS-1 Night Vision Device (NVD) Manual;
- U.S. Army Night Flight (TC 1-204);
- U.S. Army NVIS Operations, Exportable Training Package;
- U.S. Army TM 11-5855-263-10;
- Air Force TO 12S10-2AVS6-1;
- Navy NAVAIR 16-35AVS-7; and
- U.S. Border Patrol, Helicopter NVIS Ground and Flight Training Syllabus.

There may also be further documents available from European civil or military sources.

GM2 SPA.NVIS.130(f) Crew requirements

INSTRUCTION – GROUND TRAINING AREAS OF INSTRUCTION

A detailed example of possible subjects to be instructed in an NVIS ground instruction is included below. (The exact details may not always be applicable, e.g. due to goggle configuration differences.)

Table 1
Ground training areas of instruction

Item	Subject Area	Subject Details	Recommended Time
1	General anatomy and characteristics of the eye	<p>Anatomy:</p> <ul style="list-style-type: none"> • Overall structure of the eye • Cones • Rods <p>Visual deficiencies:</p> <ul style="list-style-type: none"> • myopia • hyperopia • astigmatism • presbyopia <p>Effects of light on night vision & NV protection physiology:</p> <ul style="list-style-type: none"> • Light levels <ul style="list-style-type: none"> - illumination - luminance - reflectance - contrast • Types of vision: <ul style="list-style-type: none"> - photopic - mesopic - scotopic • Day versus night vision • Dark adaptation process: <ul style="list-style-type: none"> - dark adaptation - pre-adaptive state • Purkinje shift • Ocular chromatic aberration • Photochromatic interval 	1 hour
2	Night vision human factors	<ul style="list-style-type: none"> • Night blind spot (as compared to day blind spot) • Field of view and peripheral vision • Distance estimation and depth perception: <ul style="list-style-type: none"> - monocular cues - motion parallax 	1 hour

Item	Subject Area	Subject Details	Recommended Time
		<ul style="list-style-type: none"> - geometric perspective - size constancy - overlapping contours or interposition of objects • Aerial perspective: <ul style="list-style-type: none"> - variations in colour or shade - loss of detail or texture - position of light source - direction of shadows • Binocular cues • Night vision techniques: <ul style="list-style-type: none"> - off-centre vision - scanning - shapes and silhouettes 	
		<ul style="list-style-type: none"> • Vestibular illusions • Somatogyral illusions: <ul style="list-style-type: none"> - leans - graveyard spin - coriolis illusion • Somatogravic illusions: <ul style="list-style-type: none"> - oculographic illusions - elevator illusion - oculoagravic illusions • Proprioceptive illusions • Dealing with spatial disorientation • Visual illusions: <ul style="list-style-type: none"> - auto kinetic illusion - confusion with ground lights - relative motion - reversible perspective illusion - false vertical and horizontal cues - altered planes of reference - height /depth perception illusion - flicker vertigo - fascination (fixation) - structural illusions - size-distance illusion • Helicopter design limitations: <ul style="list-style-type: none"> - windscreen condition - helicopter instrument design - helicopter structural obstruction - interior lights 	

Item	Subject Area	Subject Details	Recommended Time
		<ul style="list-style-type: none"> - exterior lights • Self-imposed stresses: <ul style="list-style-type: none"> - drugs - exhaustion - alcohol - tobacco - hypoglycaemia - injuries - physical fitness • Stress & fatigue: <ul style="list-style-type: none"> - acute vs. chronic - prevention • Hypoxia issues and night vision • Weather/environmental conditions: <ul style="list-style-type: none"> - snow (white-out) - dust (brown-out) - haze - fog - rain - light level • Astronomical lights (moon, star, northern lights) • Effects of cloud cover 	
3	NVIS general characteristics	<ul style="list-style-type: none"> • Definitions and types of NVIS: <ul style="list-style-type: none"> - light spectrum - types of NVIS • Thermal-imaging devices • Image-intensifier devices • Image-intensifier operational theory • Types of image intensifier systems: <ul style="list-style-type: none"> - generation 1 - generation 2 - generation 3 - generation 4 - type I / II - class A & B minus blue filter • NVIS equipment <ul style="list-style-type: none"> - shipping and storage case - carrying case - binocular assembly - lens caps - lens paper - operators manual 	1 hour

Item	Subject Area	Subject Details	Recommended Time
		<ul style="list-style-type: none"> - power pack (dual battery) - batteries • Characteristics of NVIS: <ul style="list-style-type: none"> - light amplification - light intensification - frequency sensitivity - visual range acuity - unaided peripheral vision - weight - flip-up device - break-away feature - neck cord - maintenance issues - human factor issues • Description and functions of NVIS components: <ul style="list-style-type: none"> - helmet visor cover and extension strap - helmet NVIS mount and attachment points - different mount options for various helmets - lock release button - vertical adjustment knob - low battery indicator - binocular assembly - monocular tubes - fore and aft adjustment knob - eye span knob - tilt adjustment lever - objective focus rings - eyepiece focus rings - battery pack 	
4	NVIS care & cleaning	<ul style="list-style-type: none"> • Handling procedures • NVIS operating instructions: <ul style="list-style-type: none"> - pre-mounting inspection - mounting procedures - focusing procedures - faults • Post-flight procedures; • Deficiencies: type and recognition of faults: <ul style="list-style-type: none"> - acceptable faults - black spots - chicken wire - fixed pattern noise (honeycomb effect) - output brightness variation 	1 hour

Item	Subject Area	Subject Details	Recommended Time
		<ul style="list-style-type: none"> - bright spots - image disparity - image distortion - emission points - unacceptable faults: <ul style="list-style-type: none"> - shading - edge glow - flashing, flickering or intermittent operation • Cleaning procedures • Care of batteries • Hazardous material considerations; 	
5	Pre- & post-flight procedures	<ul style="list-style-type: none"> • Inspect NVIS • Carrying case condition • Nitrogen purge due date • Collimation test due date • Screens diagram(s) of any faults • NVIS kit: complete • NVIS binocular assembly condition • Battery pack and quick disconnect condition • Batteries life expended so far • Mount battery pack onto helmet: <ul style="list-style-type: none"> - verify no LED showing (good battery) - fail battery by opening cap and LED illuminates (both compartments) • Mount NVIS onto helmet • Adjust and focus NVIS • Eye-span to known inter-pupillary distance • Eye piece focus ring to zero • Adjustments: <ul style="list-style-type: none"> - vertical - fore and aft - tilt - eye-span (fine-tuning) • Focus (one eye at a time at 20 ft, then at 30 ft from an eye chart) <ul style="list-style-type: none"> - objective focus ring - eye piece focus ring - verify both images are harmonised - read eye-chart 20/40 line from 20 ft • NVIS mission planning • NVIS light level planning • NVIS risk assessment 	1 hour

Item	Subject Area	Subject Details	Recommended Time
6	NVIS terrain interpretation and environmental factors	<ul style="list-style-type: none"> • Night terrain interpretation • Light sources: <ul style="list-style-type: none"> - natural - lunar - solar - starlight - northern lights - artificial - cultural - infra-red • Meteorological conditions: <ul style="list-style-type: none"> - clouds/fog - indications of restriction to visibility: - loss of celestial lights - loss of ground lights - reduced ambient light levels - reduced visual acuity - increase in video noise - increase in halo effect • Cues for visual recognition: <ul style="list-style-type: none"> - object size - object shape - contrast - ambient light - colour - texture - background - reflectivity • Factors affecting terrain interpretation: <ul style="list-style-type: none"> - ambient light - flight altitudes - terrain type • Seasons • Night navigation cues: <ul style="list-style-type: none"> - terrain relief - vegetation - hydrographical features - cultural features 	1 hour
7	NVIS training & equipment requirements	<p>Cover the relevant regulations and guidelines that pertain to night and NVIS flight to include as a minimum:</p> <ul style="list-style-type: none"> • Crew experience requirements; • Crew training requirements; 	1 hour

Item	Subject Area	Subject Details	Recommended Time
		<ul style="list-style-type: none"> • Airspace requirements; • Night / NVIS MEL; • NVIS / night weather limits; • NVIS equipment minimum standard requirements. 	
8	NVIS emergency procedures	Cover relevant emergency procedures: <ul style="list-style-type: none"> • Inadvertent IMC procedures • NVIS goggle failure • Helicopter emergencies: <ul style="list-style-type: none"> - with goggles - transition from goggles 	1 hour
9	NVIS flight techniques	Respective flight techniques for each phase of flight for the type and class of helicopter used for NVIS training	1 hour
10	Basic instrument techniques	Present and confirm understanding of basic instrument flight techniques: <ul style="list-style-type: none"> • Instrument scan • Role of instruments in NVIS flight • Unusual attitude recovery procedures 	1 hour
11	Blind cockpit drills	Perform blind cockpit drills: <ul style="list-style-type: none"> • Switches • Circuit breakers • Exit mechanisms • External / internal lighting • Avionics 	1 hour

GM3 SPA.NVIS.130(f) Crew requirements

FLIGHT TRAINING – AREAS OF INSTRUCTION

A detailed example of possible subjects to be instructed in a NVIS flight instruction is included below.

Table 1**Flight training areas of instruction**

Item	Subject Area	Subject Details	Recommended Time
1	Ground operations	<ul style="list-style-type: none"> • NVIS equipment assembly • Pre-flight inspection of NVISs • Helicopter pre-flight • NVIS flight planning: <ul style="list-style-type: none"> - light level planning - meteorology - obstacles and known hazards - risk analysis matrix - CRM concerns - NVIS emergency procedures review • Start-up/shut down • Goggling and degoggling 	1 hour
2	General handling	<ul style="list-style-type: none"> • Level turns, climbs, and descents • For helicopters, confined areas and sloped landings • Operation specific flight tasks • Transition from aided to unaided flight • Demonstration of NVIS related ambient and cultural effects 	1 hour
3	Take-offs & landings	<ul style="list-style-type: none"> • At both improved illuminated areas such as airports/airfields and unimproved unlit areas such as open fields • Traffic pattern • Low speed manoeuvres for helicopters 	1 hour
4	Navigation	<ul style="list-style-type: none"> • Navigation over variety of terrain and under different cultural lighting conditions 	1 hour
5	Emergency procedures	<ul style="list-style-type: none"> • Goggle failure • Helicopter emergencies • Inadvertent IMC • Unusual attitude recovery 	1 hour

GM4 SPA.NVIS.130(f) Crew requirements

NVIS PRE-FLIGHT BRIEFING/CHECKLIST

A detailed example of a pre-flight briefing/checklist is included below.

Table 1**NVIS pre-flight briefing/checklist**

Item	Subject
1	Weather: <ul style="list-style-type: none"> • METAR/forecast • Cloud cover/dew point spread/precipitation
2	OPS items: <ul style="list-style-type: none"> • NOTAMs • IFR publications backup/maps • Goggles adjusted using test set (RTCA Document DO-275 [NVIS MOPS], Appendices G & H give suggested NVG pre-flight and adjustment procedures and a ground test checklist)
3	Ambient light: <ul style="list-style-type: none"> • Moon rise/set/phase/position/elevation • % illumination and millilux (MLX) for duration of flight • Recommended minimum MLX: 1.5
4	Mission: <ul style="list-style-type: none"> • Mission outline • Terrain appreciation • Detailed manoeuvres • Flight timings • Start/airborne/debrief • Airspace coordination for NVIS • Obstacles/minimum safe altitude • NVIS goggle up/degoggle location/procedure • Instrument IFR checks
5	Crew: <ul style="list-style-type: none"> • Crew day/experience • Crew position • Equipment: NVIS, case, video, flashlights • Lookout duties: left hand seat (LHS) – from 90° left to 45° right, RHS – from 90° right to 45° left; • Calling of hazards/movements landing light • Transfer of control terminology • Below 100 ft AGL – pilot monitoring (PM) ready to assume control
6	Helicopter: <ul style="list-style-type: none"> • Helicopter configuration • Fuel and CG

Item	Subject
7	Emergencies: <ul style="list-style-type: none"><li data-bbox="300 277 836 309">• NVIS failure: cruise and low level flight<li data-bbox="300 322 730 353">• Inadvertent IMC/IFR recovery<li data-bbox="300 367 903 398">• Helicopter emergency: critical & non-critical

SPA.NVIS.140 Information and documentation

The operator shall ensure that, as part of its risk analysis and management process, risks associated with the NVIS environment are minimised by specifying in the operations manual: selection, composition and training of crews; levels of equipment and dispatch criteria; and operating procedures and minima, such that normal and likely abnormal operations are described and adequately mitigated.

AMC1 SPA.NVIS.140 Information and documentation

OPERATIONS MANUAL

The operations manual should include:

- (a) equipment to be carried and its limitations;
- (b) the minimum equipment list (MEL) entry covering the equipment specified;
- (c) risk analysis, mitigation and management;
- (d) pre- and post-flight procedures and documentation;
- (e) selection and composition of crew;
- (f) crew coordination procedures, including:
 - (1) flight briefing;
 - (2) procedures when one crew member is wearing NVG and/or procedures when two or more crew members are wearing NVGs;
 - (3) procedures for the transition to and from NVIS flight;
 - (4) use of the radio altimeter on an NVIS flight; and
 - (5) inadvertent instrument meteorological conditions (IMC) and helicopter recovery procedures, including unusual attitude recovery procedures;
- (g) the NVIS training syllabus;
- (h) in-flight procedures for assessing visibility, to ensure that operations are not conducted below the minima stipulated for non-assisted night VFR operations;
- (i) weather minima, taking the underlying activity into account; and
- (j) the minimum transition heights to/from an NVIS flight.

GM1 SPA.NVIS.140 Information and documentation

CONCEPT OF OPERATIONS

Night Vision Imaging System for Civil Operators

Foreword

This document, initially incorporated in JAA TGL-34, prepared by a Sub-Group of EUROCAE Working Group 57 “Night Vision Imaging System (NVIS) Standardisation” is an abbreviated and modified version of the RTCA Report DO-268 “Concept Of Operations – Night Vision Imaging Systems For Civil Operators” which was prepared in the USA by RTCA Special Committee 196 (SC-196) and approved by the RTCA Technical Management Committee in March 2001.

The EUROCAE Working Group 57 (WG-57) Terms of Reference included a task to prepare a Concept of Operations (CONOPS) document describing the use of NVIS in Europe. To complete this task, a Sub-Group of WG-57 reviewed the RTCA SC-196 CONOPS (DO-268) to assess its applicability for use in Europe. Whilst the RTCA document was considered generally applicable, some of its content, such as

crew eligibility and qualifications and the detail of the training requirements, was considered to be material more appropriately addressed in Europe by at that time other Joint Aviation Requirements (JAR) documents such as JAR-OPS and JAR-FCL. Consequently, WG-57 condensed the RTCA CONOPS document by removing this material which is either already addressed by other JAR documents or will be covered by the Agency’s documents in the future.

In addition, many of the technical standards already covered in the Minimum Operational Performance Standards (MOPS) for Integrated Night Vision Imaging System Equipment (DO-275) have been deleted in this European CONOPS.

Executive summary

The hours of darkness add to a pilot’s workload by decreasing those visual cues commonly used during daylight operations. The decreased ability of a pilot to see and avoid obstructions at night has been a subject of discussion since aviators first attempted to operate at night. Technology advancements in the late 1960s and early 1970s provided military aviators some limited ability to see at night and therein changed the scope of military night operations. Continuing technological improvements have advanced the capability and reliability of night vision imaging systems to the point that they are receiving increasing scrutiny are generally accepted by the public and are viewed by many as a tool for night flight.

Simply stated, night vision imaging systems are an aid to night VFR flight. Currently, such systems consist of a set of night vision goggles and normally a complimentary array of cockpit lighting modifications. The specifications of these two sub-system elements are interdependent and, as technology advances, the characteristics associated with each element are expected to evolve. The complete description and performance standards of the night vision goggles and cockpit lighting modifications appropriate to civil aviation are contained in the Minimum Operational Performance Standards for Integrated Night Vision Imaging System Equipment.

An increasing interest on the part of civil operators to conduct night operations has brought a corresponding increased level of interest in employing night vision imaging systems. However, the night vision imaging systems do have performance limitations. Therefore, it is incumbent on the operator to employ proper training methods and operating procedures to minimise these limitations to ensure safe operations. In turn, operators employing night vision imaging systems must have the guidance and support of their regulatory agency in order to safely train and operate with these systems.

The role of the regulatory agencies in this matter is to develop the technical standard orders for the hardware as well as the advisory material and inspector handbook materials for the operations and training aspect. In addition, those agencies charged with providing flight weather information should modify their products to include the night vision imaging systems flight data elements not currently provided.

An FAA study (DOT/FAA/RD-94/21, 1994) best summarised the need for night vision imaging systems by stating, “When properly used, NVGs can increase safety, enhance situational awareness, and reduce pilot workload and stress that are typically associated with night operations.”

Table of contents

2. TERMINOLOGY	92
2.1 Night vision goggles	92
2.1.1 Type	92
2.1.2 Class	92
2.1.2.1 Class A	92
2.1.2.2 Class B	92
2.1.2.3 Modified class B	93

2.1.3 Generation	93
3. SYSTEM DESCRIPTION	94
3.1 NVIS capabilities	94
3.1.1 Critical elements	94
3.1.2 Situation awareness	95
3.1.2.1 Environment detection and identification	95
3.1.3 Emergency situations	95
3.2.1 NVG design characteristics	95
3.2.1.1 Visual acuity	95
3.2.1.2 Field of view	95
3.2.1.3 Field of regard	95
3.2.1.4 NVG weight & centre of gravity	95
3.2.1.5 Monochromatic image	96
3.2.1.6 Ambient or artificial light	96
3.2.2 Physiological and other conditions	96
3.2.2.1 Cockpit resource management	96
3.2.2.2 Fatigue	96
3.2.2.3 Over-confidence	96
3.2.2.4 Spatial orientation	96
3.2.2.5 Depth perception & distance estimation	97
3.2.2.6 Instrument lighting brightness considerations	97
3.2.2.7 Dark adaptation time from NVG to unaided operations	97
3.2.2.8 Complacency	98
3.2.2.9 Experience	98
4. OPERATIONS	98
4.1 Pilot eligibility	98
4.2 Operating environment considerations	98
4.2.1 Weather and atmospheric obscurants	98
4.2.1.1 Weather	98
4.2.1.2 Deteriorating weather	99
4.2.1.3 Airborne obscurants	99
4.2.1.4 Winter operations	99
4.2.1.4.1 Snow	99
4.2.1.4.2 Ice fog	100
4.2.1.4.3 Icing	100
4.2.1.4.4 Low ambient temperatures	100
4.2.2 Illumination	100
4.2.2.1 Natural illumination	100
4.2.2.1.1 Moon phase	100
4.2.2.1.2 Lunar azimuth and elevation	100
4.2.2.1.3 Shadowing	100
4.2.2.1.4 Sky glow	101
4.2.2.2 Artificial illumination	101
4.2.3 Terrain contrast	101
4.3 Aircraft considerations	102
4.3.1 Lighting	102
4.3.2 Cockpit ergonomics	102
4.3.3 Windshield reflectivity	102
4.4 Generic operating considerations	102
4.4.1 Normal procedures	102
4.4.1.1 Scanning	102

4.4.1.1.1 Instrument crosscheck scan	102
4.4.1.1.2 NVG scan	103
4.4.1.1.3 Unaided scan	103
4.4.1.1.4 Scan patterns	103
4.4.1.2 Pre-flight planning	103
4.4.1.2.1 Illumination criteria	103
4.4.1.2.2 NVIS operations	103
4.4.1.2.3 Aircraft pre-flight	103
4.4.1.2.4 Equipment	104
4.4.1.2.5 Risk assessment	104
4.4.1.3 Flight operations	104
4.4.1.3.1 Elevated terrain	104
4.4.1.3.2 Over-water	104
4.4.1.4 Remote area considerations	104
4.4.1.5 Reconnaissance	104
4.4.1.6 Sources of high illumination	105
4.4.2 Emergency procedures	105
4.4.3 Inadvertent IMC	105
5. TRAINING	105
6. CONTINUING AIRWORTHINESS	105
ACRONYMS USED IN THIS GM	105
GLOSSARY OF TERMS USED IN THIS GM	106
REFERENCES	108

2. TERMINOLOGY

2.1 Night vision goggles

An NVG is a binocular appliance that amplifies ambient light and is worn by a pilot. The NVG enhances the wearer's ability to maintain visual surface reference at night.

2.1.1 Type

Type refers to the design of the NVG with regards to the manner in which the image is relayed to the pilot. A Type 1 NVG is one in which the image is viewed directly in-line with the image intensification process. A Type 1 NVG is also referred to as "direct view" goggle. A Type 2 NVG is one in which the image intensifier is not in-line with the image viewed by the pilot. In this design, the image may be reflected several times before being projected onto a combiner in front of the pilot's eyes. A Type 2 NVG is also referred to as an "indirect view" goggle.

2.1.2 Class

Class is a terminology used to describe the filter present on the NVG objective lens. The filter restricts the transmission of light below a determined frequency. This allows the cockpit lighting to be designed and installed in a manner that does not adversely affect NVG performance.

2.1.2.1 Class A

Class A or "minus blue" NVGs incorporate a filter, which generally imposes a 625 nanometer cutoff. Thus, the use of colours in the cockpit (e.g., colour displays, colour warning lights, etc.) may be limited. The blue green region of the light spectrum is allowed through the filter.

2.1.2.2 Class B

Class B NVGs incorporate a filter that generally imposes a 665 nanometer cutoff. Thus, the cockpit lighting design may incorporate more colours since the filter eliminates some yellows and oranges from entering the intensification process.

2.1.2.3 Modified class B

Modified Class B NVGs incorporate a variation of a Class B filter but also incorporates a notch filter in the green spectrum that allows a small percentage of light into the image intensification process. Therefore, a Modified Class B NVG allows pilots to view fixed head-up display (HUD) symbology through the NVG without the HUD energy adversely affecting NVG performance.

2.1.3 Generation

Generation refers to the technological design of an image intensifier. Systems incorporating these light-amplifying image intensifiers were first used during WWII and were operationally fielded by the US military during the Vietnam era. These systems were large, heavy and poorly performing devices that were unsuitable for aviation use, and were termed Generation I (Gen I). Gen II devices represented a significant technological advancement and provided a system that could be head-mounted for use in ground vehicles. Gen III devices represented another significant technological advancement in image intensification, and provided a system that was designed for aviation use. Although not yet fielded, there are prototype NVGs that include technological advances that may necessitate a Gen IV designation if placed into production. Because of the variations in interpretations as to generation, NVGs will not be referred to by the generation designation.

2.1.4 OMNIBUS

The term OMNIBUS refers to a US Army contract vehicle that has been used over the years to procure NVGs. Each successive OMNIBUS contract included NVGs that demonstrated improved performance. There have been five contracts since the mid 1980s, the most current being OMNIBUS V. There may be several variations of NVGs within a single OMNIBUS purchase, and some NVGs from previous OMNIBUS contracts have been upgraded in performance to match the performance of goggles from later contracts. Because of these variations, NVGs will not be referred to by the OMNIBUS designation.

2.1.5 Resolution and visual acuity

Resolution refers to the capability of the NVG to present an image that makes clear and distinguishable the separate components of a scene or object.

Visual acuity is the relative ability of the human eye to resolve detail and interpret an image.

2.2 Aviation night vision imaging system (NVIS)

The Night Vision Imaging System is the integration of all elements required to successfully and safely operate an aircraft with night vision goggles. The system includes at a minimum NVGs, NVIS lighting, other aircraft components, training, and continuing airworthiness.

2.2.1 Look under (under view)

Look under is the ability of pilots to look under or around the NVG to view inside and outside the aircraft.

2.3 NVIS lighting

An aircraft lighting system that has been modified or designed for use with NVGs and which does not degrade the performance of the NVG beyond acceptable standards, is designated as NVIS lighting. This can apply to both interior and exterior lighting.

2.3.1 Design considerations

As the choice of NVG filter drives the cockpit lighting design, it is important to know which goggle will be used in which cockpit. Since the filter in a Class A NVG allows wavelengths above 625 nanometers into the intensification process, it should not be used in a cockpit designed for Class B or Modified Class B NVGs. However, since the filter in a Class B and Modified Class B NVGs is more restrictive than that in a

Class ANVG, the Class B or Modified Class B NVG can be used with either Class A or Class B cockpit lighting designs.

2.3.2 Compatible

Compatibility, with respect to an NVIS system, includes a number of different factors: compatibility of internal and external lighting with the NVG, compatibility of the NVG with the crew station design (e.g., proximity of the canopy or windows, proximity of overhead panels, operability of controls, etc.), compatibility of crew equipment with the NVG and compatibility with respect to colour discrimination and identification (e.g., caution and warning lights still maintain amber and red colours). The purpose of this paragraph is to discuss compatibility with respect to aircraft lighting. An NVIS lighting system, internal and external, is considered compatible if it adheres to the following requirements:

1. the internal and external lighting does not adversely affect the operation of the NVG during any phase of the NVIS operation;
2. the internal lighting provides adequate illumination of aircraft cockpit instruments, displays and controls for unaided operations and for “look-under” viewing during aided operations; and
3. The external lighting aids in the detection and separation by other aircraft.

NVIS lighting compatibility can be achieved in a variety of ways that can include, but is not limited to, modification of light sources, light filters or by virtue of location. Once aircraft lighting is modified for using NVGs, it is important to keep in mind that changes in the crew station (e.g., addition of new display) must be assessed relative to the effect on NVIS compatibility.

2.4. NVIS operation

A night flight wherein the pilot maintains visual surface reference using NVGs in an aircraft that is NVIS approved

2.4.1 Aided

Aided flight is flight with NVGs in an operational position.

2.4.2 Unaided

Unaided flight is a flight without NVGs or a flight with NVGs in a non-operational position.

3. SYSTEM DESCRIPTION

3.1 NVIS capabilities

NVIS generally provides the pilot an image of the outside scene that is enhanced compared to that provided by the unaided, dark-adapted eye. However, NVIS may not provide the user an image equal to that observed during daylight. Since the user has an enhanced visual capability, situational awareness is generally improved.

3.1.1 Critical elements

The following critical elements are the underlying assumptions in the system description for NVIS:

1. aircraft internal lighting has been modified or initially designed to be compatible;
2. environmental conditions are adequate for the use of NVIS (e.g. enough illumination is present, weather conditions are favourable, etc.);
3. the NVIS has been properly maintained in accordance with the minimum operational performance standards;
4. a proper pre-flight has been performed on the NVIS confirming operation in accordance with the continued airworthiness standards and training guidelines; and

5. the pilot(s) has been properly trained and meets recency of experience requirements.

Even when insuring that these conditions are met, there still are many variables that can adversely affect the safe and effective use of NVIS (e.g., flying towards a low angle moon, flying in a shadowed area, flying near extensive cultural lighting, flying over low contrast terrain, etc.). It is important to understand these assumptions and limitations when discussing the capabilities provided by the use of NVIS.

3.1.2 Situation awareness

Situation awareness, being defined as the degree of perceptual accuracy achieved in the comprehension of all factors affecting an aircraft and crew at a given time, is improved at night when using NVG during NVIS operations. This is achieved by providing the pilot with more visual cues than is normally available under most conditions when operating an aircraft unaided at night. However, it is but one source of the factors necessary for maintaining an acceptable level of situational awareness.

3.1.2.1 Environment detection and identification

An advantage of using NVIS is the enhanced ability to detect, identify, and avoid terrain and/or obstacles that present a hazard to night operations. Correspondingly, NVIS aid in night navigation by allowing the aircrew to view waypoints and features.

Being able to visually locate and then (in some cases) identify objects or areas critical to operational success will also enhance operational effectiveness. Finally, use of NVIS may allow pilots to detect other aircraft more easily.

3.1.3 Emergency situations

NVIS generally improve situational awareness, facilitating the pilot's workload during emergencies. Should an emergency arise that requires an immediate landing, NVIS may provide the pilot with a means of locating a suitable landing area and conducting a landing. The pilot must determine if the use of NVIS during emergencies is appropriate. In certain instances, it may be more advantageous for the pilot to remove the NVG during the performance of an emergency procedure.

3.2.1 NVG design characteristics

There are limitations inherent in the current NVG design.

3.2.1.1 Visual acuity

The pilot's visual acuity with NVGs is less than normal daytime visual acuity.

3.2.1.2 Field of view

Unaided field of view (FOV) covers an elliptical area that is approximately 120° lateral by 80° vertical, whereas the field of view of current Type I NVG systems is nominally 40° and is circular. Both the reduced field of view of the image and the resultant decrease in peripheral vision can increase the pilot's susceptibility to misperceptions and illusions. Proper scanning techniques must be employed to reduce the susceptibility to misperception and illusions.

3.2.1.3 Field of regard

The NVG has a limited FOV but, because it is head-mounted, that FOV can be scanned when viewing the outside scene. The total area that the FOV can be scanned is called the field of regard (FOR). The FOR will vary depending on several factors: physiological limit of head movement, NVG design (e.g., protrusion of the binocular assembly, etc.) and cockpit design issues (e.g., proximity of canopy or window, seat location, canopy bow, etc.).

3.2.1.4 NVG weight & centre of gravity

The increased weight and forward CG projection of head supported devices may have detrimental effects on pilot performance due to neck muscle strain and fatigue. There also maybe an increased risk of neck injury in crashes.

3.2.1.5 Monochromatic image

The NVG image currently appears in shades of green. Since there is only one colour, the image is said to be “monochromatic”. This colour was chosen mostly because the human eye can see more detail at lower brightness levels when viewing shades of green. Colour differences between components in a scene helps one discriminate between objects and aids in object recognition, depth perception and distance estimation. The lack of colour variation in the NVG image will degrade these capabilities to varying degrees.

3.2.1.6 Ambient or artificial light

The NVG requires some degree of light (energy) in order to function. Low light levels, non-compatible aircraft lighting and poor windshield/window light transmissibility, diminish the performance capability of the NVG. It is the pilot’s responsibility to determine when to transition from aided to unaided due to unacceptable NVG performance.

3.2.2 *Physiological and other conditions*

3.2.2.1 Cockpit resource management

Due to the inherent limitations of NVIS operations, there is a requirement to place emphasis on NVIS related cockpit resource management (CRM). This applies to both single and multi-pilot cockpit environments. Consequently, NVIS flight requires effective CRM between the pilot(s), controlling agencies and other supporting personnel. An appropriate venue for addressing this issue is the pre-flight NVIS mission brief.

3.2.2.2 Fatigue

Physiological limitations that are prevalent during the hours of darkness along with the limitations associated with NVGs, may have a significant impact on NVIS operations. Some of these limitations are the effects of fatigue (both acute and chronic), stress, eyestrain, working outside the pilot’s normal circadian rhythm envelope, increased helmet weight, aggressive scanning techniques associated with NVIS, and various human factors engineering concerns that may have a direct influence on how the pilot works in the aircraft while wearing NVGs. These limitations may be mitigated through proper training and recognition, experience, adaptation, rest, risk management, and proper crew rest/duty cycles.

3.2.2.3 Over-confidence

Compared to other types of flight operations, there may be an increased tendency by the pilot to over-estimate the capabilities of the NVIS.

3.2.2.4 Spatial orientation

There are two types of vision used in maintaining spatial orientation: central (focal) vision and peripheral (ambient) vision. Focal vision requires conscious processing and is slow, whereas peripheral information is processed subconsciously at a very fast rate. During daytime, spatial orientation is maintained by inputs from both focal vision and peripheral vision, with peripheral vision providing the great majority of the information. When using NVGs, peripheral vision can be significantly degraded if not completely absent. In this case, the pilot must rely on focal vision to interpret the NVG image as well as the information from flight instruments in order to maintain spatial orientation and situation awareness. Even though maintaining spatial orientation requires more effort when using NVGs than during daytime, it is much improved over night unaided operations where the only information is obtained through flight instruments. However, anything that degrades the NVG image to a point where the horizon is not visualised and/or ground reference is lost or significantly degraded will necessitate a reversion to flight on instruments until adequate external visual references can be established. Making this transition quickly and effectively is vital in order to avoid spatial disorientation. Additionally, added focal task loading during the operation (e.g., communications, looking at displays, processing navigational information, etc.) will compete with the focal requirement for interpreting the NVG image and flight instruments. Spatial disorientation can result when the task loading increases to a point where the

outside scene and/or the flight instruments are not properly scanned. This potential can be mitigated to some extent through effective training and experience.

3.2.2.5 Depth perception & distance estimation

When flying, it is important for pilots to be able to accurately employ depth perception and distance estimation techniques. To accomplish this, pilots use both binocular and monocular vision. Binocular vision requires the use of both eyes working together, and, practically speaking, is useful only out to approximately 100 ft.

Binocular vision is particularly useful when flying close to the ground and/or near objects (e.g. landing a helicopter in a small landing zone). Monocular vision can be accomplished with either eye alone, and is the type of vision used for depth perception and distance estimation when viewing beyond approximately 100 ft. Monocular vision is the predominant type of vision used when flying fixed wing aircraft, and also when flying helicopters and using cues beyond 100 ft. When viewing an NVG image, the two eyes can no longer provide accurate binocular information, even though the NVG used when flying is a binocular system. This has to do with the way the eyes function physiologically (e.g. accommodation, stereopsis, etc.) and the design of the NVG (i.e. a binocular system with a fixed channel for each eye). Therefore, binocular depth perception and distance estimation tasking when viewing terrain or objects with an NVG within 100 ft is significantly degraded. Since monocular vision does not require both eyes working together, the adverse impact on depth perception and distance estimation is much less, and is mostly dependent on the quality of the NVG image. If the image is very good and there are objects in the scene to use for monocular cueing (especially objects with which the pilot is familiar), then distance estimation and depth perception tasking will remain accurate. However, if the image is degraded (e.g., low illumination, airborne obscurants, etc.) and/or there are few or unfamiliar objects in the scene, depth perception and distance estimation will be degraded to some extent. In summary, pilots using NVG will maintain the ability to accurately perceive depth and estimate distances, but it will depend on the distances used and the quality of the NVG image.

Pilots maintain some ability to perceive depth and distance when using NVGs by employing monocular cues. However, these capabilities may be degraded to varying degrees.

3.2.2.6 Instrument lighting brightness considerations

When viewing the NVG image, the brightness of the image will affect the amount of time it takes to adapt to the brightness level of the instrument lighting, thereby affecting the time it takes to interpret information provided by the instruments. For example, if the instrument lighting is fairly bright, the time it takes to interpret information provided by the instruments may be instantaneous. However, if the brightness of the lighting is set to a very low level, it may take several seconds to interpret the information, thus increasing the heads-down time and increasing the risk of spatial disorientation. It is important to ensure that instrument lighting is kept at a brightness level that makes it easy to rapidly interpret the information. This will likely be brighter than one is used to during unaided operations.

3.2.2.7 Dark adaptation time from NVG to unaided operations

When viewing an NVG image, both rods and cones are being stimulated (i.e., mesopic vision), but the brightness of the image is reducing the effectiveness of rod cells. If the outside scene is bright enough (e.g., urban area, bright landing pad, etc.), both rods and cones will continue to be stimulated. In this case there will be no improvement in acuity over time and the best acuity is essentially instantaneous. In some cases (e.g., rural area with scattered cultural lights), the outside scene will not be bright enough to stimulate the cones and some amount of time will be required for the rods to fully adapt. In this case it may take the rods one to two minutes to fully adapt for the best acuity to be realised. If the outside scene is very dark (e.g., no cultural lights and no moon), it may take up to five minutes to fully adapt to the outside scene after removing the NVGs. The preceding are general guidelines and the time required to fully adapt to the outside scene once removing the NVG depends on many variables: the length of time the NVG has been used, whether or not the pilot was dark adapted prior to flight, the brightness of the outside scene, the brightness of cockpit lighting, and variability in visual function among the

population. It is important to understand the concept and to note the time requirements for the given operation.

3.2.2.8 Complacency

Pilots must understand the importance of avoiding complacency during NVG flights. Similar to other specialised flight operations, complacency may lead to an acceptance of situations that would normally not be permitted. Attention span and vigilance are reduced, important elements in a task series are overlooked, and scanning patterns, which are essential for situational awareness, break down (usually due to fixation on a single instrument, object or task). Critical but routine tasks are often skipped.

3.2.2.9 Experience

High levels of NVIS proficiency, along with a well-balanced NVIS experience base, will help to offset many of the visual performance degradations associated with night operations. NVIS experience is a result of proper training coupled with numerous NVIS operations. An experienced NVIS pilot is acutely aware of the NVIS operational envelope and its correlation to various operational effects, visual illusions and performance limitations. This experience base is gained (and maintained) over time through a continual, holistic NVIS training programme that exposes the pilot to NVIS operations conducted under various moon angles, percentage of available illumination, contrast levels, visibility levels, and varying degrees of cloud coverage. A pilot should be exposed to as many of these variations as practicable during the initial NVIS qualification programme. Continued exposure during the NVIS recurrent training will help strengthen and solidify this experience base.

4. OPERATIONS

Operations procedures should accommodate the capabilities and limitations of the systems described in Section 3 of this GM as well as the restraints of the operational environment.

All NVG operations should fulfil all applicable requirements in accordance with Regulation (EC) No 216/2008.

4.1 Pilot eligibility

About 54% of the civil pilot population wears some sort of ophthalmic device to correct vision necessary to safely operate an aircraft. The use of inappropriate ophthalmic devices with NVGs may result in vision performance decrement, fatigue, and other human factor problems, which could result in increased risk for aviation accidents and incidents.

4.2 Operating environment considerations

4.2.1 Weather and atmospheric obscurants

Any atmospheric condition, which absorbs, scatters, or refracts illumination, either before or after it strikes terrain, may reduce the usable energy available to the NVG.

4.2.1.1 Weather

During NVIS operations, pilots can see areas of moisture that are dense (e.g., clouds, thick fog, etc.) but may not see areas that are less dense (e.g., thin fog, light rain showers, etc.). The inability to see some areas of moisture may lead to hazardous flight conditions during NVIS operations and will be discussed separately in the next section.

The different types of moisture will have varying effects and it is important to understand these effects and how they apply to NVIS operations. For example:

1. It is important to know when and where fog may form in the flying area. Typically, coastal, low-lying river, and mountainous areas are most susceptible.

2. Light rain or mist may not be observed with NVIS but will affect contrast, distance estimation, and depth perception. Heavy rain is more easily perceived due to large droplet size and energy attenuation.
3. Snow occurs in a wide range of particle sizes, shapes, and densities. As with clouds, rain, and fog, the denser the airborne snow, the greater the effect on NVG performance. On the ground, snow has mixed effect depending on terrain type and the illumination level. In mountainous terrain, snow may add contrast, especially if trees and rocks protrude through the snow. In flatter terrain, snow may cover high contrast areas, reducing them to areas of low contrast. On low illumination nights, snow may reflect the available energy better than the terrain it covers and thus increase the level of illumination.

All atmospheric conditions reduce the illumination level to some degree and recognition of this reduction with NVGs can be difficult. Thus, a good weather briefing, familiarity with the local weather patterns and understanding the effects on NVG performance are important for a successful NVIS flight.

4.2.1.2 Deteriorating weather

It is important to remain cognizant of changes in the weather when using NVGs. It is possible to “see through” areas of light moisture when using NVGs, thus increasing the risk of inadvertently entering IMC. Some ways to help reduce this possibility include the following:

1. Be attentive to changes in the NVG image. Halos may become larger and more diffuse due to diffraction of light in moisture. Scintillation in the image may increase due to a lowering of the illumination level caused by the increased atmospheric moisture. Loss of scene detail may be secondary to the lowering illumination caused by the changing moisture conditions.
2. Obtain a thorough weather brief with emphasis on NVG effects prior to flight.
3. Be familiar with weather patterns in the flying area.
4. Occasionally scan the outside scene. The unaided eye may detect weather conditions that are not detectable to the NVG.

Despite the many methods of inadvertent instrument meteorological conditions (IMC) prevention, one should have established IMC recovery procedures and be familiar with them.

4.2.1.3 Airborne obscurants

In addition to weather, there may be other obscurants in the atmosphere that could block energy from reaching the NVG, such as haze, dust, sand, or smoke. As with moisture, the size and concentration of the particles will determine the degree of impact. Examples of these effects include the following:

1. high winds during the day can place a lot of dust in the air that will still be present at night when the wind may have reduced in intensity;
2. forest fires produce heavy volumes of smoke that may cover areas well away from the fire itself;
3. the effects of rotor wash may be more pronounced when using NVGs depending on the material (e.g. sand, snow, dust, etc.); and
4. pollution in and around major cultural areas may have an adverse effect on NVG performance.

4.2.1.4 Winter operations

Using NVGs during winter conditions provide unique issues and challenges to pilots.

4.2.1.4.1 Snow

Due to the reflective nature of snow, it presents pilots with significant visual challenges both en-route and in the terminal area. During the en-route phase of a flight the snow may cause distractions to the flying pilot if any aircraft external lights (e.g., anti-collision beacons/strobes, position lights, landing lights, etc.) are not compatible with NVGs. In the terminal area, whiteout landings can create the greatest

hazard to unaided night operations. With NVGs the hazard is not lessened, and can be more disorienting due to lights reflecting from the snow that is swirling around the aircraft during the landing phase. Any emergency vehicle lighting or other airport lighting in the terminal area may exaggerate the effects.

4.2.1.4.2 Ice fog

Ice fog presents the pilot with hazards normally associated with IMC in addition to problems associated with snow operations. The highly reflective nature of ice fog will further aggravate any lighting problems. Ice fog conditions can be generated by aircraft operations under extremely cold temperatures and the right environmental conditions.

4.2.1.4.3 Icing

Airframe ice is difficult to detect while looking through NVGs. The pilot will need to develop a proper crosscheck to ensure airframe icing does not exceed operating limits for that aircraft. Pilots should already be aware of icing indicator points on their aircraft. These areas require consistent oversight to properly determine environmental conditions.

4.2.1.4.4 Low ambient temperatures

Depending on the cockpit heating system, fogging of the NVGs can be a problem and this will significantly reduce the goggle effectiveness. Another issue with cockpit temperatures is the reduced battery duration. Operations in a cold environment may require additional battery resources.

4.2.2 Illumination

NVGs require illumination, either natural or artificial, to produce an image. Although current NVG technology has significantly improved low light level performance, some illumination, whether natural or artificial, is still required to provide the best possible image.

4.2.2.1 Natural illumination

The main sources of natural illumination include the moon and stars. Other sources can include sky glow, the aurora borealis, and ionisation processes that take place in the upper atmosphere.

4.2.2.1.1 Moon phase

The moon provides the greatest source of natural illumination during night time. Moon phase and elevation determines how much moonlight will be available, while moonrise and moonset times determine when it will be available. Lunar illumination is reported in terms of percent illumination, 100% illumination being full moon. It should be noted that this is different from the moon phase (e.g., 25% illumination does not mean the same thing as a quarter moon). Currently, percent lunar illumination can only be obtained from sources on the Internet, military weather facilities and some publications (e.g. Farmers Almanac).

4.2.2.1.2 Lunar azimuth and elevation

The moon can have a detrimental effect on night operations depending on its relationship to the flight path. When the moon is on the same azimuth as the flight path, and low enough to be within or near the NVG field of view, the effect on NVG performance will be similar to that caused by the sun on the unaided eye during daytime. The brightness of the moon drives the NVG gain down, thus reducing image detail. This can also occur with the moon at relatively high elevations. For example, it is possible to bring the moon near the NVG field of view when climbing to cross a ridgeline or other obstacle, even when the moon is at a relatively high elevation. It is important to consider lunar azimuth and elevation during pre-flight planning. Shadowing, another effect of lunar azimuth and elevation, will be discussed separately.

4.2.2.1.3 Shadowing

Moonlight creates shadows during night time just as sunlight creates shadows during daytime. However, night time shadows contain very little energy for the NVG to use in forming an image. Consequently,

image quality within a shadow will be degraded relative to that obtained outside the shadowed area. Shadows can be beneficial or can be a disadvantage to operations depending on the situation.

4.2.2.1.3.1 Benefits of shadows

Shadows alert aircrew to subtle terrain features that may not otherwise be noted due to the reduced resolution in the NVG image. This may be particularly important in areas where there is little contrast differentiation; such as flat featureless deserts, where large dry washes and high sand dunes may go unnoticed if there is no contrast to note their presence. The contrast provided by shadows helps make the NVG scene appear more natural.

4.2.2.1.3.2 Disadvantages due to shadows

When within a shadow, terrain detail can be significantly degraded, and objects can be regarding flight in or around shadowed areas is the pilot's response to loss of terrain detail. During flight under good illumination conditions, a pilot expects to see a certain level of detail. If flight into a shadow occurs while the pilot is preoccupied with other matters (e.g., communication, radar, etc.), it is possible that the loss in terrain detail may not have been immediately noted. Once looking outside again, the pilot may think the reduced detail is due to an increase in flight altitude and thus begin a descent - even though already at a low altitude. Consideration should be given during mission planning to such factors as lunar azimuth and elevation, terrain type (e.g., mountainous, flat, etc.), and the location of items significant to operation success (e.g., ridgelines, pylons, targets, waypoints, etc.). Consideration of these factors will help predict the location of shadows and the potential adverse effects.

4.2.2.1.4 Sky glow

Sky glow is an effect caused by solar light and continues until the sun is approximately 18 degrees below the horizon. When viewing in the direction of sky glow there may be enough energy present to adversely affect the NVG image (i.e., reduce image quality). For the middle latitudes the effect on NVG performance may last up to an hour after official sunset. For more northern and southern latitudes the effect may last for extended periods of times (e.g., days to weeks) during seasons when the sun does not travel far below the horizon. This is an important point to remember if planning NVG operations in those areas. Unlike sky glow after sunset, the sky glow associated with sunrise does not have an obvious effect on NVG performance until fairly close to official sunrise. The difference has to do with the length of time the atmosphere is exposed to the sun's irradiation, which causes ionisation processes that release near-IR energy. It is important to know the difference in these effects for planning purposes.

4.2.2.2 Artificial illumination

Since the NVGs are sensitive to any source of energy in the visible and near infrared spectrums, there are also many types of artificial illumination sources (e.g., flares, IR searchlights, cultural lighting, etc). As with any illumination source, these can have both positive and detrimental effects on NVG utilisation. For example, viewing a scene indirectly illuminated by a searchlight can enable the pilot to more clearly view the scene; conversely, viewing the same scene with the searchlight near or within the NVG field of view will reduce the available visual cues. It is important to be familiar with the effects of cultural lighting in the flying area in order to be able to avoid the associated problems and to be able to use the advantages provided. Also, it is important to know how to properly use artificial light sources (e.g., aircraft IR spotlight). It should be noted that artificial light sources may not always be available or dependable, and this should be taken into consideration during flight planning.

4.2.3 Terrain contrast

Contrast is one of the more important influences on the ability to correctly interpret the NVG image, particularly in areas where there are few cultural features. Any terrain that contains varying albedos (e.g., forests, cultivated fields, etc.) will likely increase the level of contrast in a NVG image, thus enhancing detail. The more detail in the image, the more visual information aircrews have for manoeuvring and navigating. Low contrast terrain (e.g., flat featureless desert, snow-covered fields,

water, etc.) contains few albedo variations, thus the NVG image will contain fewer levels of contrast and less detail.

4.3 Aircraft considerations

4.3.1 Lighting

Factors such as aircraft internal and external lighting have the potential to adversely impact NVG gain and thus image quality. How well the windshield, canopy, or window panels transmit near infrared energy can also affect the image. Cleanliness of the windshield directly impacts this issue.

4.3.2 Cockpit ergonomics

While wearing NVGs, the pilot may have limited range of head movement in the aircraft. For example, switches on the overhead console may be difficult to read while wearing NVGs. Instruments, controls, and switches that are ordinarily accessible, may now be more difficult to access due to the extended mass (fore/aft) associated with NVGs.

In addition, scanning may require a more concentrated effort due to limited field of view. Lateral viewing motion can be hindered by cockpit obstructions (i.e. door post or seat back design).

4.3.3 Windshield reflectivity

Consideration within the cockpit and cabin should be given to the reflectivity of materials and equipment upon the windshield. Light that is reflected may interfere with a clear and unobstructed view. Items such as flight suits, helmets, and charts, if of a light colour such as white, yellow, and orange, can produce significant reflections. Colours that impart the least reflection are black, purple, and blue. This phenomenon is not limited to windshields but may include side windows, chin bubbles, canopies, etc.

4.4 Generic operating considerations

This section lists operating topics and procedures, which should be considered when employing NVIS. The list and associated comments are not to be considered all inclusive. NVIS operations vary in scope widely and this section is not intended to instruct a prospective operator on how to implement an NVIS programme.

4.4.1 Normal procedures

4.4.1.1 Scanning

When using NVGs there are three different scan patterns to consider and each is used for different reasons: instrument scan, aided scan outside, and unaided scan outside. Normally, all three are integrated and there is a continuous transition from one to the other depending on the mission, environmental conditions, immediate tasking, flight altitude and many other variables. For example, scanning with the NVG will allow early detection of external lights. However, the bloom caused by the lights will mask the aircraft until fairly close or until the lighting scheme is changed. Once close to the aircraft (e.g., approximately one-half mile for smaller aircraft), visual acquisition can possibly be made unaided or with the NVG. Whether to use the NVG or unaided vision depends on many variables (e.g., external lighting configuration, distance to aircraft, size of aircraft, environmental conditions, etc.). The points to be made are that a proper scan depends on the situation and variables present, and that scanning outside is critical when close to another aircraft. Additionally, for a multi-crew environment, coordination of scan responsibilities is vital.

4.4.1.1.1 Instrument crosscheck scan

In order to effect a proper and effective instrument scan, it is important to predict when it will be important. A start can be made during pre-flight planning when critical phases of flight can be identified and prepared for. For example, it may be possible when flying over water or featureless terrain to employ a good instrument crosscheck. However, the most important task is to make the appropriate decision during flight as conditions and events change. In this case, experience, training and constant attention to the situation are vital contributors to the pilot's assessment of the situation.

4.4.1.1.2 NVG scan

To counteract the limited field of view, pilots should continually scan throughout the field of regard. This allows aircrew to build a mental image of the surrounding environment. How quickly the outside scene is scanned to update the mental image is determined by many variables. For example, when flying over flat terrain where the highest obstacle is below the flight path, the scan may be fairly slow. However, if flying low altitude in mountainous terrain, the scan will be more aggressive and rapid due to the presence of more information and the increased risk. How much of the field of regard to scan is also determined by many variables. For example, if a pilot is anticipating a turn, more attention may be placed in the area around the turn point, or in the direction of the new heading. In this situation, the scan will be limited briefly to only a portion of the field of regard.

As with the instrument scan, it is very important to plan ahead. It may, for example, be possible to determine when the scan may be interrupted due to other tasks, when it may be possible to become fixated on a specific task, or when it is important to maximise the outside scan. An important lesson to learn regarding the NVG scan is when not to rely on visual information. It is easy to overestimate how well one can see with NVGs, especially on high illumination nights, and it is vital to maintain a constant awareness regarding their limitations. This should be pointed out often during training and, as a reminder, should be included as a briefing item for NVG flights.

4.4.1.1.3 Unaided scan

Under certain conditions, this scan can be as important as the others can. For example, it may be possible to detect distance and/or closure to another aircraft more easily using unaided vision, especially if the halo caused by the external lights is masking aircraft detail on the NVG image. Additionally, there are other times when unaided information can be used in lieu of or can augment NVG and instrument information.

4.4.1.1.4 Scan patterns

Environmental factors will influence scan by limiting what may be seen in specific directions or by degrading the overall image. If the image is degraded, aircrew may scan more aggressively in a subconscious attempt to obtain more information, or to avoid the chance of missing information that suddenly appears and/or disappears. The operation itself may influence the scan pattern. For example, looking for another aircraft, landing zone, or airport may require focusing the scan in a particular direction. In some cases, the operation may require aircrew in a multi place aircraft to assign particular pilots responsibility for scanning specific sectors.

The restrictions to scan and the variables affecting the scan pattern are not specific to night operations or the use of NVGs, but, due to the NVG's limited field of view, the degree of impact is magnified.

4.4.1.2 Pre-flight planning

4.4.1.2.1 Illumination criteria

The pilot should provide a means for forecasting the illumination levels in the operational area. The pilot should make the effort to request at least the following information in addition to that normally requested for night VFR: cloud cover and visibility during all phases of flight, sunset, civil and nautical twilight, moon phase, moonrise and moonset, and moon and/or lux illumination levels, and unlit tower NOTAMS.

4.4.1.2.2 NVIS operations

An inspection of the power pack, visor, mount, power cable and the binocular assembly should be performed in accordance with the operations manual.

To ensure maximum performance of the NVGs, proper alignment and focus must be accomplished following the equipment inspection. Improper alignment and focus may degrade NVIS performance.

4.4.1.2.3 Aircraft pre-flight

A normal pre-flight inspection should be conducted prior to an NVIS flight with emphasis on proper operation of the NVIS lighting. The aircraft windshield must also be clean and free of major defects, which might degrade NVIS performance.

4.4.1.2.4 Equipment

The basic equipment required for NVIS operations should be those instruments and equipment specified within the current applicable regulations for VFR night operations. Additional equipment required for NVIS operations, e.g. NVIS lighting system and a radio altimeter must be installed and operational. All NVIS equipment, including any subsequent modifications, shall be approved.

4.4.1.2.5 Risk assessment

A risk assessment is suggested prior to any NVIS operation. The risk assessment should include as a minimum:

1. illumination level
2. weather
3. pilot recency of experience
4. pilot experience with NVG operations
5. pilot vision
6. pilot rest condition and health
7. windshield/window condition
8. NVG tube performance
9. NVG battery condition
10. types of operations allowed
11. external lighting environment.

4.4.1.3 Flight operations

4.4.1.3.1 Elevated terrain

Safety may be enhanced by NVGs during operations near elevated terrain at night. The obscuration of elevated terrain is more easily detected with NVGs thereby allowing the pilot to make alternate flight path decisions.

4.4.1.3.2 Over-water

Flying over large bodies of water with NVGs is difficult because of the lack of contrast in terrain features. Reflections of the moon or starlight may cause disorientation with the natural horizon. The radio altimeter must be used as a reference to maintain altitude.

4.4.1.4 Remote area considerations

A remote area is a site that does not qualify as an aerodrome as defined by the applicable regulations. Remote area landing sites do not have the same features as an aerodrome, so extra care must be given to locating any obstacles that may be in the approach/departure path.

A reconnaissance must be made prior to descending at an unlighted remote site. Some features or objects may be easy to detect and interpret with the unaided eye. Other objects will be invisible to the unaided eye, yet easily detected and evaluated with NVGs.

4.4.1.5 Reconnaissance

The reconnaissance phase should involve the coordinated use of NVGs and white lights. The aircraft's external white lights such as landing lights, searchlights, and floodlights, should be used during this phase

of flight. The pilot should select and evaluate approach and departure paths to the site considering wind speed and direction, and obstacles or signs of obstacles.

4.4.1.6 Sources of high illumination

Sources of direct high illumination may have the potential to reduce the effectiveness of the NVGs. In addition, certain colour lights, such as red, will appear brighter, closer and may display large halos.

4.4.2 Emergency procedures

No modification for NVG operations is necessary to the aircraft emergency procedures as approved in the operations manual or approved checklist. Special training may be required to accomplish the appropriate procedures.

4.4.3 Inadvertent IMC

Some ways to help reduce the potential for inadvertent flight into IMC conditions are:

1. obtaining a thorough weather brief (including pilot reports);
2. being familiar with weather patterns in the local flying area; and
3. by looking beneath the NVG at the outside scene.

However, even with thorough planning a risk still exists. To help mitigate this risk it is important to know how to recognise subtle changes to the NVG image that occur during entry into IMC conditions. Some of these include the onset of scintillation, loss of scene detail, and changes in the appearance of halos.

5. TRAINING

To provide an appropriate level of safety, training procedures must accommodate the capabilities and limitations of the systems described in Section 3 of this GM as well as the restraints of the operational environment.

To be effective, the NVIS training philosophy would be based on a two-tiered approach: basic and advanced NVIS training. The basic NVIS training would serve as the baseline standard for all individuals seeking an NVIS endorsement. The content of this initial training would not be dependent on any operational requirements. The advanced training would build on the basic training by focusing on developing specialised skills required to operate an aircraft during NVIS operations in a particular operational environment. Furthermore, while there is a need to stipulate minimum flight hour requirements for an NVIS endorsement, the training must also be event based. This necessitates that pilots be exposed to all of the relevant aspects, or events, of NVIS flight in addition to acquiring a minimum number of flight hours.

6. CONTINUING AIRWORTHINESS

The reliability of the NVIS and safety of operations are dependent on the pilots adhering to the instructions for continuing airworthiness. Personnel who conduct the maintenance and inspection on the NVIS must be qualified and possess the appropriate tools and facilities to perform the maintenance.

Acronyms used in this GM

AC	Advisory Circular
AGL	above ground level
ATC	air traffic control
CONOPs	concept of operations

CG	centre of gravity
CRM	cockpit resource management
DOD	Department of Defence
DOT	Department of Transportation
EFIS	electronic flight instrumentation systems
EMS	emergency medical service
FAA	Federal Aviation Administration
FLIR	forward looking infrared radar
FOR	field of regard
FOV	field of view
GEN	generation
HUD	head-up display
IFR	instrument flight rules
IMC	instrument meteorological conditions
IR	infrared
JAA	Joint Aviation Authorities
MOPS	Minimum Operational Performance Standard
NAS	national airspace system
NOTAMS	Notices to Airmen
NVD	night vision device
NVED	night vision enhancement device
NVG	night vision goggles
NVIS	night vision imaging system
SC	special committee
TFR	temporary flight restrictions
VA	visual acuity
VFR	visual flight rules
VMC	visual meteorological conditions

Glossary of terms used in this GM

1. 'Absorptance': the ratio of the radiant energy absorbed by a body to that incident upon it.
2. 'Albedo': the ratio of the amount of light reflected from a surface to the amount of incident light.
3. 'Automatic brightness control (ABC)': one of the automatic gain control circuits found in second and third generation NVG devices. It attempts to provide consistent image output brightness by automatic control of the micro channel plate voltage.
4. 'Automatic gain control (AGC)': comprised of the automatic brightness control and bright source protection circuits. Is designed to maintain image brightness and protect the user and the image tube from excessive light levels. This is accomplished by controlling the gain of the intensifier tube.

5. 'Blackbody': an ideal body of surface that completely absorbs all radiant energy falling upon with no reflection.
6. 'Blooming': common term used to denote the "washing out" of all or part of the NVG image due to de-gaining of the image intensifier tube when a bright light source is in or near the NVG field of view.
7. 'Bright source protection (BSP)': protective feature associated with second and third generation NVGs that protects the intensifier tube and the user by controlling the voltage at the photo cathode.
8. 'Brownout': condition created by blowing sand, dust, etc., which can cause the pilots to lose sight of the ground. This is most commonly associated with landings in the desert or in dusty LZs.
9. 'Civil nautical twilight': the time when the true altitude of the centre of the sun is six degrees below the horizon. Illuminance level is approximately 3.40 lux and is above the usable level for NVG operations.
10. 'Diopter': a measure of the refractive (light bending) power of a lens.
11. 'Electro-optics (EO)': the term used to describe the interaction between optics and electronics, leading to transformation of electrical energy into light or vice versa.
12. 'Electroluminescent (EL)': referring to light emission that occurs from application of an alternating current to a layer of phosphor.
13. 'Foot-candle': a measure of illuminance; specifically, the illuminance of a surface upon which one lumen is falling per square foot.
14. 'Foot-Lambert': a measure of luminance; specifically the luminance of a surface that is receiving an illuminance of one foot-candle.
15. 'Gain': when referring to an image intensification tube, the ratio of the brightness of the output in units of foot-lambert, compared to the illumination of the input in foot-candles. A typical value for a GEN III tube is 25,000 to 30,000 FI/fc. A "tube gain" of 30,000 FI/fc provides an approximate "system gain" of 3,000. This means that the intensified NVG image is 3,000 times brighter to the aided eye than that of the unaided eye.
16. 'Illuminance': also referred to as illumination. The amount, ratio or density of light that strikes a surface at any given point.
17. 'Image intensifier': an electro-optic device used to detect and intensify optical images in the visible and near infrared region of the electromagnetic spectrum for the purpose of providing visible images. The component that actually performs the intensification process in a NVG. This component is composed of the photo cathode, MCP, screen optic, and power supply. It does not include the objective and eyepiece lenses.
18. 'Incandescent': refers to a source that emits light based on thermal excitation, i.e., heating by an electrical current, resulting in a very broad spectrum of energy that is dependent primarily on the temperature of the filament.
19. 'Infrared': that portion of the electromagnetic spectrum in which wavelengths range from 0.7 microns to 1 mm. This segment is further divided into near infrared (0.7-3.0 microns), mid infrared (3.0-6.0 microns), far infrared (6.0-15 microns), and extreme infrared (15 microns-1 mm). A NVG is sensitive to near infrared wavelengths approaching 0.9 microns.
20. 'Irradiance': the radiant flux density incident on a surface. For the purpose of this document the terms irradiance and illuminance shall be interchangeable.
21. 'Lumen': a measurement of luminous flux equal to the light emitted in a unit solid angle by a uniform point source of one candle intensity.

22. 'Luminance': the luminous intensity (reflected light) of a surface in a given direction per unit of projected area. This is the energy used by NVGs.
23. 'Lux': a unit measurement of illumination. The illuminance produced on a surface that is one-meter square, from a uniform point source of one candle intensity, or one lumen per square meter.
24. 'Microchannel plate': a wafer containing between 3 and 6 million specially treated microscopic glass tubes designed to multiply electrons passing from the photo cathode to the phosphor screen in second and third generation intensifier tubes.
25. 'Micron': a unit of measure commonly used to express wavelength in the infrared region; equal to one millionth of a meter.
26. 'Nanometer (nm)': a unit of measure commonly used to express wavelength in the visible and near infrared region; equal to one billionth of a meter.
27. 'Night vision device (NVD)': an electro-optical device used to provide a visible image using the electromagnetic energy available at night.
28. 'Photon': a quantum (basic unit) of radiant energy (light).
29. 'Photopic vision': vision produced as a result of the response of the cones in the retina as the eye achieves a light adapted state (commonly referred to as day vision).
30. 'Radiance': the flux density of radiant energy reflected from a surface. For the purposes of this manual the terms radiance and luminance shall be interchangeable.
31. 'Reflectivity': the fraction of energy reflected from a surface.
32. 'Scotopic vision': that vision produced as a result of the response of the rods in the retina as the eye achieves a dark-adapted state (commonly referred to as night vision).
33. 'Situational awareness (SA)': degree of perceptual accuracy achieved in the comprehension of all factors affecting an aircraft and crew at a given time.
34. 'Starlight': the illuminance provided by the available (observable) stars in a subject hemisphere. The stars provide approximately 0.00022 lux ground illuminance on a clear night. This illuminance is equivalent to about one-quarter of the actual light from the night sky with no moon.
35. 'Stereopsis': visual system binocular cues that are used for distance estimation and depth perception. Three dimensional visual perception of objects. The use of NVGs seriously degrades this aspect of near-depth perception.
36. 'Transmittance': the fraction of radiant energy that is transmitted through a layer of absorbing material placed in its path.
37. 'Ultraviolet': that portion of the electromagnetic spectrum in which wavelengths range between 0.1 and 0.4 microns.
38. 'Wavelength': the distance in the line of advance of a wave from any one point to the next point of corresponding phase; is used to express electromagnetic energy including IR and visible light.
39. 'Whiteout': a condition similar to brownout but caused by blowing snow.

References

1. Air Force Manual 11-217 Volume 2, Chapter 3, *Night Vision Devices*, August 6, 1998.
2. Department of Army, Training Circular 1-204, *Night Flight: Techniques and Procedures*, 1988.
3. DOT/FAA, Report no DOT/FAA/RD-94/21– Night Vision Goggles in Emergency Medical Services (EMS) Helicopters, March 1994.

4. FAA, Guide for Aviation Medical Examiners, November 1996.
5. FAA, Notice for Proposed Rulemaking Statement- Night Vision Goggles, Draft, September 7, 1999.
6. FAA Handbook 8083-21, *Rotorcraft Flying Handbook*, 2000.
7. FAA Operation Specification, Rocky Mountain Helicopters Night Vision Goggle Operations, February 4, 1999.
8. FAA Supplemental Type Certificate Number SR09208RC, Rocky Mountain Holdings, BO-105, January 19, 1999.
9. FAA, *Aeronautical Information Manual (AIM)*, February 24, 2000.
10. ITT Industries, Operator's Manual-Image Intensifier Set, Night Vision AV4949UL, June 21, 1999.
11. RTCA, Inc. – *Basic Document Style Guide*, July 1999.
12. JAA, *JAR-OPS Night Vision Goggle Operations*, Draft, 1999.
13. Mobility Air Forces, Concept of Operations-Aircrew Night Vision Goggles, September 8, 1998.
14. Perfetto, Nicholas J., Embry-Riddle Aeronautical University, The Feasibility of Metropolitan Police Department Helicopter Pilots Using Night Vision Goggles, May 2000.
15. Simpson, Carol Dr., William, Doug., Gardner, Donald., Haworth, Loran., Analysis of Response to Survey of Issues in the Application of Night Vision Goggles to Civil Rotorcraft Flight Operations, Draft, July 12, 1999.
16. United States Marine Corps, Marine Aviation Weapons and Tactics Squadron One, *Helicopter Night Vision Device Manual*, Summer 1995.

SUBPART I: HELICOPTER HOIST OPERATIONS

SPA.HHO.100 Helicopter hoist operations (HHO)

- (a) Helicopters shall only be operated for the purpose of CAT hoist operations if the operator has been approved by the competent authority.
- (b) To obtain such approval by the competent authority, the operator shall:
 - (1) operate in CAT and hold a CAT AOC in accordance with Annex III (Part-ORO);
 - (2) demonstrate to the competent authority compliance with the requirements contained in this Subpart.

SPA.HHO.110 Equipment requirements for HHO

- (a) The installation of all helicopter hoist equipment, including any radio equipment to comply with SPA.HHO.115, and any subsequent modifications, shall have an airworthiness approval appropriate to the intended function. Ancillary equipment shall be designed and tested to the appropriate standard as required by the competent authority.
- (b) Maintenance instructions for HHO equipment and systems shall be established by the operator in liaison with the manufacturer and included in the operator's helicopter maintenance programme as required by Regulation (EC) No 2042/2003.

AMC1 SPA.HHO.110(a) Equipment requirements for HHO

AIRWORTHINESS APPROVAL FOR HUMAN EXTERNAL CARGO

- (a) Hoist installations that have been certificated according to any of the following standards should be considered to satisfy the airworthiness criteria for human external cargo (HEC) operations:
 - (1) CS 27.865 or CS 29.865;
 - (2) JAR 27 Amendment 2 (27.865) or JAR 29 Amendment 2 (29.865) or later;
 - (3) FAR 27 Amendment 36 (27.865) or later - including compliance with CS 27.865(c)(6); or
 - (4) FAR 29 Amendment 43 (29.865) or later.
- (b) Hoist installations that have been certified prior to the issuance of the airworthiness criteria for HEC as defined in (a) may be considered as eligible for HHO provided that following a risk assessment either:
 - (1) the service history of the hoist installation is found satisfactory to the competent authority;
or
 - (2) for hoist installations with an unsatisfactory service history, additional substantiation to allow acceptance by the competent authority should be provided by the hoist installation certificate holder (type certificate (TC) or supplemental type certificate (STC)) on the basis of the following requirements:
 - (i) The hoist installation should withstand a force equal to a limit static load factor of 3.5, or some lower load factor, not less than 2.5, demonstrated to be the maximum

load factor expected during hoist operations, multiplied by the maximum authorised external load.

- (ii) The reliability of the primary and back-up quick release systems at helicopter level should be established and failure mode and effect analysis at equipment level should be available. The assessment of the design of the primary and back-up quick release systems should consider any failure that could be induced by a failure mode of any other electrical or mechanical rotorcraft system.
- (iii) The operations or flight manual contains one-engine-inoperative (OEI) hover performance data and procedures for the weights, altitudes, and temperatures throughout the flight envelope for which hoist operations are accepted.
- (iv) Information concerning the inspection intervals and retirement life of the hoist cable should be provided in the instructions for continued airworthiness.
- (v) Any airworthiness issue reported from incidents or accidents and not addressed by (i), (ii), (iii) and (iv) should be addressed.

SPA.HHO.115 HHO communication

Two-way radio communication shall be established with the organisation for which the HHO is being provided and, where possible, a means of communicating with ground personnel at the HHO site for:

- (a) day and night offshore operations;
- (b) night onshore operations, except for HHO at a helicopter emergency medical services (HEMS) operating site.

SPA.HHO.125 Performance requirements for HHO

Except for HHO at a HEMS operating site, HHO shall be capable of sustaining a critical engine failure with the remaining engine(s) at the appropriate power setting without hazard to the suspended person(s)/cargo, third parties or property.

SPA.HHO.130 Crew requirements for HHO

- (a) *Selection*. The operator shall establish criteria for the selection of flight crew members for the HHO task, taking previous experience into account.
- (b) *Experience*. The minimum experience level for the commander conducting HHO flights shall not be less than:
 - (1) Offshore:
 - (i) 1000 hours as pilot-in-command/commander of helicopters, or 1000 hours as co-pilot in HHO of which 200 hours is as pilot-in-command under supervision; and
 - (ii) 50 hoist cycles conducted offshore, of which 20 cycles shall be at night if night operations are being conducted, where a hoist cycle means one down-and-up cycle of the hoist hook.
 - (2) Onshore:
 - (i) 500 hours as pilot-in-command/commander of helicopters, or 500 hours as co-pilot in HHO of which 100 hours is as pilot-in-command under supervision;
 - (ii) 200 hours operating experience in helicopters gained in an operational environment similar to the intended operation; and
 - (iii) 50 hoist cycles, of which 20 cycles shall be at night if night operations are being conducted.
- (c) *Operational training and experience*. Successful completion of training in accordance with the HHO procedures contained in the operations manual and relevant experience in the role and environment under which HHO are conducted.
- (d) *Recency*. All pilots and HHO crew members conducting HHO shall have completed in the last 90 days:
 - (1) when operating by day: any combination of three day or night hoist cycles, each of which shall include a transition to and from the hover;
 - (2) when operating by night: three night hoist cycles, each of which shall include a transition to and from the hover.
- (e) *Crew composition*. The minimum crew for day or night operations shall be as stated in the operations manual. The minimum crew will be dependent on the type of helicopter, the weather

conditions, the type of task, and, in addition for offshore operations, the HHO site environment, the sea state and the movement of the vessel. In no case shall the minimum crew be less than one pilot and one HHO crew member.

- (f) Training and checking
- (1) Training and checking shall be conducted in accordance with a detailed syllabus approved by the competent authority and included in the operations manual.
 - (2) Crew members:
 - (i) Crew training programmes shall: improve knowledge of the HHO working environment and equipment; improve crew coordination; and include measures to minimise the risks associated with HHO normal and emergency procedures and static discharge.
 - (ii) The measures referred to in (f)(2)(i) shall be assessed during visual meteorological conditions (VMC) day proficiency checks, or VMC night proficiency checks when night HHO are undertaken by the operator.

AMC1 SPA.HHO.130(b)(2)(ii) Crew requirements for HHO

RELEVANT EXPERIENCE

The experience considered should take into account the geographical characteristics (sea, mountain, big cities with heavy traffic, etc.).

AMC1 SPA.HHO.130(e) Crew requirements for HHO

CRITERIA FOR TWO PILOT HHO

A crew of two pilots should be used when:

- (a) the weather conditions are below VFR minima at the offshore vessel or structure;
- (b) there are adverse weather conditions at the HHO site (i.e. turbulence, vessel movement, visibility); and
- (c) the type of helicopter requires a second pilot to be carried because of:
 - (1) cockpit visibility;
 - (2) handling characteristics; or
 - (3) lack of automatic flight control systems.

AMC1 SPA.HHO.130(f)(1) Crew requirements for HHO

TRAINING AND CHECKING SYLLABUS

- (a) The flight crew training syllabus should include the following items:
 - (1) fitting and use of the hoist;
 - (2) preparing the helicopter and hoist equipment for HHO;
 - (3) normal and emergency hoist procedures by day and, when required, by night;
 - (4) crew coordination concepts specific to HHO;

-
- (5) practice of HHO procedures; and
 - (6) the dangers of static electricity discharge.
- (b) The flight crew checking syllabus should include:
- (1) proficiency checks, which should include procedures likely to be used at HHO sites with special emphasis on:
 - (i) local area meteorology;
 - (ii) HHO flight planning;
 - (iii) HHO departures;
 - (iv) a transition to and from the hover at the HHO site;
 - (v) normal and simulated emergency HHO procedures; and
 - (vi) crew coordination.
- (c) HHO technical crew members should be trained and checked in the following items:
- (1) duties in the HHO role;
 - (2) fitting and use of the hoist;
 - (3) operation of hoist equipment;
 - (4) preparing the helicopter and specialist equipment for HHO;
 - (5) normal and emergency procedures;
 - (6) crew coordination concepts specific to HHO;
 - (7) operation of inter-communication and radio equipment;
 - (8) knowledge of emergency hoist equipment;
 - (9) techniques for handling HHO passengers;
 - (10) effect of the movement of personnel on the centre of gravity and mass during HHO;
 - (11) effect of the movement of personnel on performance during normal and emergency flight conditions;
 - (12) techniques for guiding pilots over HHO sites;
 - (13) awareness of specific dangers relating to the operating environment; and
 - (14) the dangers of static electricity discharge.

SPA.HHO.135 HHO passenger briefing

Prior to any HHO flight, or series of flights, HHO passengers shall have been briefed and made aware of the dangers of static electricity discharge and other HHO considerations.

SPA.HHO.140 Information and documentation

- (a) The operator shall ensure that, as part of its risk analysis and management process, risks associated with the HHO environment are minimised by specifying in the operations manual: selection, composition and training of crews; levels of equipment and dispatch criteria; and operating procedures and minima, such that normal and likely abnormal operations are described and adequately mitigated.
- (b) Relevant extracts from the operations manual shall be available to the organisation for which the HHO is being provided.

AMC1 SPA.HHO.140 Information and documentation

OPERATIONS MANUAL

The operations manual should include:

- (a) performance criteria;
- (b) if applicable, the conditions under which offshore HHO transfer may be conducted including the relevant limitations on vessel movement and wind speed;
- (c) the weather limitations for HHO;
- (d) the criteria for determining the minimum size of the HHO site, appropriate to the task;
- (e) the procedures for determining minimum crew; and
- (f) the method by which crew members record hoist cycles.

SUBPART J: HELICOPTER EMERGENCY MEDICAL SERVICE OPERATIONS

SPA.HELMS.100 Helicopter emergency medical service (HEMS) operations

- (a) Helicopters shall only be operated for the purpose of HEMS operations if the operator has been approved by the competent authority.
- (b) To obtain such approval by the competent authority, the operator shall:
 - (1) operate in CAT and hold a CAT AOC in accordance with Annex III (Part-ORO);
 - (2) demonstrate to the competent authority compliance with the requirements contained in this Subpart.

GM1 SPA.HELMS.100(a) Helicopter emergency medical service (HEMS) operations

THE HELMS PHILOSOPHY

(a) Introduction

This GM outlines the HEMS philosophy. Starting with a description of acceptable risk and introducing a taxonomy used in other industries, it describes how risk has been addressed in this Subpart to provide a system of safety to the appropriate standard. It discusses the difference between HEMS and air ambulance - in regulatory terms. It also discusses the application of operations to public interest sites in the HEMS context.

(b) Acceptable risk

The broad aim of any aviation legislation is to permit the widest spectrum of operations with the minimum risk. In fact it may be worth considering who/what is at risk and who/what is being protected. In this view three groups are being protected:

- (1) third parties (including property) - highest protection;
- (2) passengers (including patients); and
- (3) crew members (including technical crew members) – lowest.

It is for the Legislator to facilitate a method for the assessment of risk - or as it is more commonly known, safety management (refer to Part-ORO).

(c) Risk management

Safety management textbooks² describe four different approaches to the management of risk. All but the first have been used in the production of this section and, if it is considered that the engine failure accountability of performance class 1 equates to zero risk, then all four are used

² Reason, J., 1997. Managing the Risks of Organizational Accidents. Ashgate, Farnham.

(this of course is not strictly true as there are a number of helicopter parts - such as the tail rotor which, due to a lack of redundancy, cannot satisfy the criteria):

- (1) Applying the taxonomy to HELMS gives:
 - (i) zero risk; no risk of accident with a harmful consequence – performance class 1 (within the qualification stated above) - the HELMS operating base;
 - (ii) de minimis; minimised to an acceptable safety target - for example the exposure time concept where the target is less than 5×10^{-8} (in the case of elevated final approach and take-off areas (elevated FATOs) at hospitals in a congested hostile environment the risk is contained to the deck edge strike case - and so in effect minimised to an exposure of seconds);
 - (iii) comparative risk; comparison to other exposure - the carriage of a patient with a spinal injury in an ambulance that is subject to ground effect compared to the risk of a HELMS flight (consequential and comparative risk);
 - (iv) as low as reasonably practicable; where additional controls are not economically or reasonably practicable - operations at the HELMS operating site (the accident site).
- (2) HELMS operations are conducted in accordance with the requirements contained in Annex IV (Part-CAT) and Annex III (Part-ORO), except for the variations contained in SPA.HELMS, for which a specific approval is required. In simple terms there are three areas in HELMS operations where risk, beyond that allowed in Part-CAT and Part-ORO, are identified and related risks accepted:
 - (i) in the en-route phase, where alleviation is given from height and visibility rules;
 - (ii) at the accident site, where alleviation is given from the performance and size requirement; and
 - (iii) at an elevated hospital site in a congested hostile environment, where alleviation is given from the deck edge strike - providing elements of the CAT.POL.H.305 are satisfied.

In mitigation against these additional and considered risks, experience levels are set, specialist training is required (such as instrument training to compensate for the increased risk of inadvertent entry into cloud) and operation with two crew (two pilots, or one pilot and a HELMS technical crew member) is mandated. (HELMS crews and medical passengers are also expected to operate in accordance with good crew resource management (CRM) principles.)

(d) Air ambulance

In regulatory terms, air ambulance is considered to be a normal transport task where the risk is no higher than for operations to the full OPS.CAT and Part-ORO compliance. This is not intended to contradict/complement medical terminology but is simply a statement of policy; none of the risk elements of HELMS should be extant and therefore none of the additional requirements of HELMS need be applied.

To provide a road ambulance analogy:

- (1) if called to an emergency: an ambulance would proceed at great speed, sounding its siren and proceeding against traffic lights - thus matching the risk of operation to the risk of a potential death (= HELMS operations);

- (2) for a transfer of a patient (or equipment) where life and death (or consequential injury of ground transport) is not an issue: the journey would be conducted without sirens and within normal rules of motoring - once again matching the risk to the task (= air ambulance operations).

The underlying principle is that the aviation risk should be proportionate to the task.

It is for the medical professional to decide between HELMS or air ambulance - not the pilot. For that reason, medical staff who undertake to task medical sorties should be fully aware of the additional risks that are (potentially) present under HELMS operations (and the pre-requisite for the operator to hold a HELMS approval). (For example in some countries, hospitals have principal and alternative sites. The patient may be landed at the safer alternative site (usually in the grounds of the hospital) thus eliminating risk - against the small inconvenience of a short ambulance transfer from the site to the hospital.)

Once the decision between HELMS or air ambulance has been taken by the medical professional, the commander makes an operational judgement over the conduct of the flight.

Simplistically, the above type of air ambulance operations could be conducted by any operator holding an Air Operator Certificate (AOC) (HELMS operators hold an AOC) - and usually are when the carriage of medical supplies (equipment, blood, organs, drugs etc.) is undertaken and when urgency is not an issue.

- (e) Operating under a HELMS approval

There are only two possibilities: transportation as passengers or cargo under the full auspices of OPS.CAT and Part-ORO (this does not permit any of the alleviations of SPA.HELMS - landing and take-off performance should be in compliance with the performance Subparts of Part-CAT), or operations under a HELMS approval as contained in this Subpart.

- (f) HELMS operational sites

The HELMS philosophy attributes the appropriate levels of risk for each operational site; this is derived from practical considerations and in consideration of the probability of use. The risk is expected to be inversely proportional to the amount of use of the site. The types of site are as follows:

- (1) HELMS operating base: from which all operations will start and finish. There is a high probability of a large number of take-offs and landings at this HELMS operating base and for that reason no alleviation from operating procedures or performance rules are contained in this Subpart.
- (2) HELMS operating site: because this is the primary pick-up site related to an incident or accident, its use can never be pre-planned and therefore attracts alleviations from operating procedures and performance rules, when appropriate.
- (3) The hospital site: is usually at ground level in hospital grounds or, if elevated, on a hospital building. It may have been established during a period when performance criteria were not a consideration. The amount of use of such sites depends on their location and their facilities; normally, it will be greater than that of the HELMS operating site but less than for a HELMS operating base. Such sites attract some alleviation under this Subpart.

- (g) Problems with hospital sites

During implementation of the original HELMS rules contained in JAR-OPS 3, it was established that a number of States had encountered problems with the impact of performance rules where helicopters were operated for HELMS. Although States accept that progress should be made

towards operations where risks associated with a critical engine failure are eliminated, or limited by the exposure time concept, a number of landing sites exist that do not (or never can) allow operations to performance class 1 or 2 requirements.

These sites are generally found in a congested hostile environment:

- (1) in the grounds of hospitals; or
- (2) on hospital buildings.

The problem of hospital sites is mainly historical and, whilst the authority could insist that such sites are not used – or used at such a low weight that critical engine failure performance is assured – it would seriously curtail a number of existing operations.

Even though the rule for the use of such sites in hospital grounds for HEMS operations attracts alleviation, it is only partial and will still impact upon present operations.

Because such operations are performed in the public interest, it was felt that the authority should be able to exercise its discretion so as to allow continued use of such sites provided that it is satisfied that an adequate level of safety can be maintained - notwithstanding that the site does not allow operations to performance class 1 or 2 standards. However, it is in the interest of continuing improvements in safety that the alleviation of such operations be constrained to existing sites, and for a limited period.

It is felt that the use of public interest sites should be controlled. This will require that a State directory of sites be kept and approval given only when the operator has an entry in the route manual section of the operations manual.

The directory (and the entry in the operations manual) should contain for each approved site:

- (i) the dimensions;
- (ii) any non-conformance with ICAO Annex 14;
- (iii) the main risks; and
- (iv) the contingency plan should an incident occur.

Each entry should also contain a diagram (or annotated photograph) showing the main aspects of the site.

(h) Summary

In summary, the following points are considered to be pertinent to the HEMS philosophy and HEMS regulations:

- (1) absolute levels of safety are conditioned by society;
- (2) potential risk must only be to a level proportionate to the task;
- (3) protection is afforded at levels appropriate to the occupants;
- (4) this Subpart addresses a number of risk areas and mitigation is built in;
- (5) only HEMS operations are dealt with by this Subpart;
- (6) there are three main categories of HEMS sites and each is addressed appropriately; and
- (7) State alleviation from the requirement at a hospital site is available but such alleviations should be strictly controlled by a system of registration.

SPA.HELMS.110 Equipment requirements for HELMS operations

The installation of all helicopter dedicated medical equipment and any subsequent modifications and, where appropriate, its operation shall be approved in accordance with Regulation (EU) No 748/2012.

SPA.HELMS.115 Communication

In addition to that required by CAT.IDE.H, helicopters conducting HELMS flights shall have communication equipment capable of conducting two-way communication with the organisation for which the HELMS is being conducted and, where possible, to communicate with ground emergency service personnel.

SPA.HELMS.120 HELMS operating minima

- (a) HELMS flights operated in performance class 1 and 2 shall comply with the weather minima in Table 1 for dispatch and en-route phase of the HELMS flight. In the event that during the en-route phase the weather conditions fall below the cloud base or visibility minima shown, helicopters certified for flights only under VMC shall abandon the flight or return to base. Helicopters equipped and certified for instrument meteorological conditions (IMC) operations may abandon the flight, return to base or convert in all respects to a flight conducted under instrument flight rules (IFR), provided the flight crew are suitably qualified.

Table 1			
HELMS operating minima			
2 PILOTS		1 PILOT	
DAY			
Ceiling	Visibility	Ceiling	Visibility
500 ft and above	As defined by the applicable airspace VFR minima	500 ft and above	As defined by the applicable airspace VFR minima
499 - 400 ft	1000 m ^(*)	499 – 400 ft	2 000 m
2 PILOTS		1 PILOT	
399 - 300 ft	2 000 m	399 – 300 ft	3 000 m
NIGHT			
Cloud base	Visibility	Cloud base	Visibility
1 200 ft ^(**)	2 500 m	1 200 ft ^(**)	3 000 m

- (*) During the en-route phase visibility may be reduced to 800 m for short periods when in sight of land if the helicopter is manoeuvred at a speed that will give adequate opportunity to observe any obstacles in time to avoid a collision.

- (**) During the en-route phase, cloud base may be reduced to 1 000 ft for short periods.
- (b) The weather minima for the dispatch and en-route phase of a HELMS flight operated in performance class 3 shall be a cloud ceiling of 600 ft and a visibility of 1500 m. Visibility may be reduced to 800 m for short periods when in sight of land if the helicopter is manoeuvred at a speed that will give adequate opportunity to observe any obstacle and avoid a collision.

GM1 SPA.HELMS.120 HELMS operating minima

REDUCED VISIBILITY

- (a) In the rule the ability to reduce the visibility for short periods has been included. This will allow the commander to assess the risk of flying temporarily into reduced visibility against the need to provide emergency medical service, taking into account the advisory speeds included in Table 1. Since every situation is different it was not felt appropriate to define the short period in terms of absolute figures. It is for the commander to assess the aviation risk to third parties, the crew and the aircraft such that it is proportionate to the task, using the principles of GM1 SPA.HELMS.100(a).
- (b) When flight with a visibility of less than 5 km is permitted, the forward visibility should not be less than the distance travelled by the helicopter in 30 seconds so as to allow adequate opportunity to see and avoid obstacles (see table below).

Table 1

Operating minima – reduced visibility

Visibility (m)	Advisory speed (kt)
800	50
1 500	100
2 000	120

SPA.HEMS.125 Performance requirements for HEMS operations

- (a) Performance class 3 operations shall not be conducted over a hostile environment.
- (b) Take-off and landing
 - (1) Helicopters conducting operations to/from a final approach and take-off area (FATO) at a hospital that is located in a congested hostile environment and that is used as a HEMS operating base shall be operated in accordance with performance class 1.
 - (2) Helicopters conducting operations to/from a FATO at a hospital that is located in a congested hostile environment and that is not a HEMS operating base shall be operated in accordance with performance class 1, except when the operator holds an approval in accordance with CAT.POL.H.225.
 - (3) Helicopters conducting operations to/from a HEMS operating site located in a hostile environment shall be operated in accordance with performance class 2 and be exempt from the approval required by CAT.POL.H.305(a), provided compliance is shown with CAT.POL.H.305(b)(2) and (b)(3).
 - (4) The HEMS operating site shall be big enough to provide adequate clearance from all obstructions. For night operations, the site shall be illuminated to enable the site and any obstructions to be identified.

GM1 SPA.HEMS.125(b)(3) Performance requirements for HEMS operations

PERFORMANCE CLASS 2 OPERATIONS AT A HEMS OPERATING SITE

As the risk profile at a HEMS operating site is already well known, operations without an assured safe forced landing capability do not need a separate approval and the requirements does not call for the additional risk assessment that is specified in CAT.POL.H.305 (b)(1).

AMC1 SPA.HEMS.125(b)(4) Performance requirements for HEMS operations

HEMS OPERATING SITE DIMENSIONS

- (a) When selecting a HEMS operating site it should have a minimum dimension of at least 2 x D (the largest dimensions of the helicopter when the rotors are turning). For night operations, unsurveyed HEMS operating sites should have dimensions of at least 4 x D in length and 2 x D in width.
- (b) For night operations, the illumination may be either from the ground or from the helicopter.

SPA.HEMS.130 Crew requirements

- (a) *Selection.* The operator shall establish criteria for the selection of flight crew members for the HEMS task, taking previous experience into account.
- (b) *Experience.* The minimum experience level for the commander conducting HEMS flights shall not be less than:
- (1) either:
 - (i) 1 000 hours as pilot-in-command/commander of aircraft of which 500 hours are as pilot-in-command/commander on helicopters; or
 - (ii) 1 000 hours as co-pilot in HEMS operations of which 500 hours are as pilot-in-command under supervision and 100 hours pilot-in-command/commander of helicopters;
 - (2) 500 hours' operating experience in helicopters, gained in an operational environment similar to the intended operation; and
 - (3) for pilots engaged in night operations, 20 hours of VMC at night as pilot-in-command/commander.
- (c) *Operational training.* Successful completion of operational training in accordance with the HEMS procedures contained in the operations manual.
- (d) *Recency.* All pilots conducting HEMS operations shall have completed a minimum of 30 minutes' flight by sole reference to instruments in a helicopter or in an FSTD within the last six months.
- (e) Crew composition
- (1) *Day flight.* The minimum crew by day shall be one pilot and one HEMS technical crew member.
 - (i) This may be reduced to one pilot only when:
 - (A) at a HEMS operating site the commander is required to fetch additional medical supplies. In such case the HEMS technical crew member may be left to give assistance to ill or injured persons while the commander undertakes this flight;
 - (B) after arriving at the HEMS operating site, the installation of the stretcher precludes the HEMS technical crew member from occupying the front seat; or
 - (C) the medical passenger requires the assistance of the HEMS technical crew member in flight.
 - (ii) In the cases described in (i), the operational minima shall be as defined by the applicable airspace requirements; the HEMS operating minima contained in Table 1 of SPA.HEMS.120 shall not be used.
 - (iii) Only in the case described in (i)(A) may the commander land at a HEMS operating site without the technical crew member assisting from the front seat.
 - (2) *Night flight.* The minimum crew by night shall be:
 - (i) two pilots; or
 - (ii) one pilot and one HEMS technical crew member in specific geographical areas defined by the operator in the operations manual taking into account the following:

- (A) adequate ground reference;
 - (B) flight following system for the duration of the HEMS mission;
 - (C) reliability of weather reporting facilities;
 - (D) HEMS minimum equipment list;
 - (E) continuity of a crew concept;
 - (F) minimum crew qualification, initial and recurrent training;
 - (G) operating procedures, including crew coordination;
 - (H) weather minima; and
 - (I) additional considerations due to specific local conditions.
- (f) Crew training and checking
- (1) Training and checking shall be conducted in accordance with a detailed syllabus approved by the competent authority and included in the operations manual.
 - (2) Crew members
 - (i) Crew training programmes shall: improve knowledge of the HEMS working environment and equipment; improve crew coordination; and include measures to minimise the risks associated with en-route transit in low visibility conditions, selection of HEMS operating sites and approach and departure profiles.
 - (ii) The measures referred to in (f)(2)(i) shall be assessed during:
 - (A) VMC day proficiency checks, or VMC night proficiency checks when night HEMS operations are undertaken by the operator; and
 - (B) line checks.

AMC1 SPA.HEMS.130(b)(2) Crew requirements

EXPERIENCE

The minimum experience level for a commander conducting HEMS flights should take into account the geographical characteristics of the operation (sea, mountain, big cities with heavy traffic, etc.).

AMC1 SPA.HEMS.130(d) Crew requirements

RECENCY

This recency may be obtained in a visual flight rules (VFR) helicopter using vision limiting devices such as goggles or screens, or in an FSTD.

AMC1 SPA.HEMS.130(e) Crew requirements

HEMS TECHNICAL CREW MEMBER

- (a) When the crew is composed of one pilot and one HEMS technical crew member, the latter should be seated in the front seat (co-pilot seat) during the flight, so as to be able to carry out his/her primary task of assisting the commander in:
 - (1) collision avoidance;

- (2) the selection of the landing site; and
 - (3) the detection of obstacles during approach and take-off phases.
- (b) The commander may delegate other aviation tasks to the HELMS technical crew member, as necessary:
- (1) assistance in navigation;
 - (2) assistance in radio communication/radio navigation means selection;
 - (3) reading of checklists; and
 - (4) monitoring of parameters.
- (c) The commander may also delegate to the HELMS technical crew member tasks on the ground:
- (1) assistance in preparing the helicopter and dedicated medical specialist equipment for subsequent HELMS departure; or
 - (2) assistance in the application of safety measures during ground operations with rotors turning (including: crowd control, embarking and disembarking of passengers, refuelling etc.).
- (d) There may be exceptional circumstances when it is not possible for the HELMS technical crew member to carry out his/her primary task as defined under (a).
- This is to be regarded as exceptional and is only to be conducted at the discretion of the commander, taking into account the dimensions and environment of the HELMS operating site.)
- (e) When two pilots are carried, there is no requirement for a HELMS technical crew member, provided that the pilot monitoring performs the aviation tasks of a technical crew member.

GM1 SPA.HELMS.130(e)(2)(ii) Crew requirements

SPECIFIC GEOGRAPHICAL AREAS

In defining those specific geographical areas, the operator should take account of the cultural lighting and topography. In those areas where the cultural lighting and topography make it unlikely that the visual cues would degrade sufficiently to make flying of the aircraft problematical, the HELMS technical crew member is assumed to be able to sufficiently assist the pilot, since under such circumstances instrument and control monitoring would not be required. In those cases where instrument and control monitoring would be required the operations should be conducted with two pilots.

AMC1 SPA.HELMS.130(e)(2)(ii)(B) Crew requirements

FLIGHT FOLLOWING SYSTEM

A flight following system is a system providing contact with the helicopter throughout its operational area.

AMC1 SPA.HELMS.130(f)(1) Crew requirements

TRAINING AND CHECKING SYLLABUS

- (a) The flight crew training syllabus should include the following items:

- (1) meteorological training concentrating on the understanding and interpretation of available weather information;
 - (2) preparing the helicopter and specialist medical equipment for subsequent HELMS departure;
 - (3) practice of HELMS departures;
 - (4) the assessment from the air of the suitability of HELMS operating sites; and
 - (5) the medical effects air transport may have on the patient.
- (b) The flight crew checking syllabus should include:
- (1) proficiency checks, which should include landing and take-off profiles likely to be used at HELMS operating sites; and
 - (2) line checks, with special emphasis on the following:
 - (i) local area meteorology;
 - (ii) HELMS flight planning;
 - (iii) HELMS departures;
 - (iv) the selection from the air of HELMS operating sites;
 - (v) low level flight in poor weather; and
 - (vi) familiarity with established HELMS operating sites in the operator's local area register.
- (c) HELMS technical crew members should be trained and checked in the following items:
- (1) duties in the HELMS role;
 - (2) map reading, navigation aid principles and use;
 - (3) operation of radio equipment;
 - (4) use of on-board medical equipment;
 - (5) preparing the helicopter and specialist medical equipment for subsequent HELMS departure;
 - (6) instrument reading, warnings, use of normal and emergency checklists in assistance of the pilot as required;
 - (7) basic understanding of the helicopter type in terms of location and design of normal and emergency systems and equipment;
 - (8) crew coordination;
 - (9) practice of response to HELMS call out;
 - (10) conducting refuelling and rotors running refuelling;
 - (11) HELMS operating site selection and use;
 - (12) techniques for handling patients, the medical consequences of air transport and some knowledge of hospital casualty reception;
 - (13) marshalling signals;
 - (14) underslung load operations as appropriate;
 - (15) winch operations as appropriate;
 - (16) the dangers to self and others of rotor running helicopters including loading of patients; and

(17) the use of the helicopter inter-communications system.

AMC1 SPA.HEMS.130(f)(2)(ii)(B) Crew requirements

LINE CHECKS

Where due to the size, the configuration, or the performance of the helicopter, the line check cannot be conducted on an operational flight, it may be conducted on a specially arranged representative flight. This flight may be immediately adjacent to, but not simultaneous with, one of the biannual proficiency checks.

SPA.HELMS.135 HELMS medical passenger and other personnel briefing

- (a) *Medical passenger.* Prior to any HELMS flight, or series of flights, medical passengers shall have been briefed to ensure that they are familiar with the HELMS working environment and equipment, can operate on-board medical and emergency equipment and can take part in normal and emergency entry and exit procedures.
- (b) *Ground emergency service personnel.* The operator shall take all reasonable measures to ensure that ground emergency service personnel are familiar with the HELMS working environment and equipment and the risks associated with ground operations at a HELMS operating site.
- (c) *Medical patient.* Notwithstanding CAT.OP.MPA.170, a briefing shall only be conducted if the medical condition makes this practicable.

AMC1 SPA.HELMS.135(a) HELMS medical passenger and other personnel briefing

HEMS MEDICAL PASSENGER BRIEFING

The briefing should ensure that the medical passenger understands his/her role in the operation, which includes:

- (a) familiarisation with the helicopter type(s) operated;
- (b) entry and exit under normal and emergency conditions both for self and patients;
- (c) use of the relevant on-board specialist medical equipment;
- (d) the need for the commander's approval prior to use of specialised equipment;
- (e) method of supervision of other medical staff;
- (f) the use of helicopter inter-communication systems;
- (g) location and use of on board fire extinguishers; and
- (h) the operator's crew coordination concept including relevant elements of crew resource management.

AMC1.1 SPA.HELMS.135(a) HELMS medical passenger and other personnel briefing

HEMS MEDICAL PASSENGER BRIEFING

Another means of complying with the rule as compared to that contained in AMC1-SPA.HELMS.135(a) is to make use of a training programme as mentioned in AMC1.1 CAT.OP.MPA.170.

AMC1 SPA.HELMS.135(b) HELMS medical passenger and other personnel briefing

GROUND EMERGENCY SERVICE PERSONNEL

- (a) The task of training large numbers of emergency service personnel is formidable. Wherever possible, helicopter operators should afford every assistance to those persons responsible for training emergency service personnel in HELMS support. This can be achieved by various means, such as, but not limited to, the production of flyers, publication of relevant information on the operator's web site and provision of extracts from the operations manual.
- (b) The elements that should be covered include:
 - (1) two-way radio communication procedures with helicopters;

- (2) the selection of suitable HEMS operating sites for HEMS flights;
- (3) the physical danger areas of helicopters;
- (4) crowd control in respect of helicopter operations; and
- (5) the evacuation of helicopter occupants following an on-site helicopter accident.

SPA.HEMS.140 Information and documentation

- (a) The operator shall ensure that, as part of its risk analysis and management process, risks associated with the HEMS environment are minimised by specifying in the operations manual: selection, composition and training of crews; levels of equipment and dispatch criteria; and operating procedures and minima, such that normal and likely abnormal operations are described and adequately mitigated.
- (b) Relevant extracts from the operations manual shall be made available to the organisation for which the HEMS is being provided.

AMC1 SPA.HEMS.140 Information and documentation

OPERATIONS MANUAL

The operations manual should include:

- (a) the use of portable equipment on board;
- (b) guidance on take-off and landing procedures at previously unsurveyed HEMS operating sites;
- (c) the final reserve fuel, in accordance with SPA.HEMS.150;
- (d) operating minima;
- (e) recommended routes for regular flights to surveyed sites, including the minimum flight altitude;
- (f) guidance for the selection of the HEMS operating site in case of a flight to an unsurveyed site;
- (g) the safety altitude for the area overflown; and
- (h) procedures to be followed in case of inadvertent entry into cloud.

SPA.HELMS.145 HELMS operating base facilities

- (a) If crew members are required to be on standby with a reaction time of less than 45 minutes, dedicated suitable accommodation shall be provided close to each operating base.
- (b) At each operating base the pilots shall be provided with facilities for obtaining current and forecast weather information and shall be provided with satisfactory communications with the appropriate air traffic services (ATS) unit. Adequate facilities shall be available for the planning of all tasks.

SPA.HELMS.150 Fuel supply

- (a) When the HELMS mission is conducted under VFR within a local and defined geographical area, standard fuel planning can be employed provided the operator establishes final reserve fuel to ensure that, on completion of the mission the fuel remaining is not less than an amount of fuel sufficient for:
 - (1) 30 minutes of flying time at normal cruising conditions; or
 - (2) when operating within an area providing continuous and suitable precautionary landing sites, 20 minutes of flying time at normal cruising speed.

SPA.HELMS.155 Refuelling with passengers embarking, on board or disembarking

When the commander considers refuelling with passengers on board to be necessary, it can be undertaken either rotors stopped or rotors turning provided the following requirements are met:

- (a) door(s) on the refuelling side of the helicopter shall remain closed;
- (b) door(s) on the non-refuelling side of the helicopter shall remain open, weather permitting;
- (c) fire fighting facilities of the appropriate scale shall be positioned so as to be immediately available in the event of a fire; and
- (d) sufficient personnel shall be immediately available to move patients clear of the helicopter in the event of a fire.

SUBPART K: HELICOPTER OFFSHORE OPERATIONS

SPA.HOFO.100 Helicopter offshore operations (HOFO)

The requirements of this Subpart apply to:

- (a) a commercial air transport operator holding a valid AOC in accordance with Part-ORO;
- (b) a specialised operations operator having declared its activity in accordance with Part-ORO; or
- (c) a non-commercial operator having declared its activity in accordance with Part-ORO.

SPA.HOFO.105 Approval for helicopter offshore operations

- (a) Prior to engaging in operations under this Subpart, a specific approval by the competent authority shall have been issued to the operator.
- (b) To obtain such approval, the operator shall submit an application to the competent authority as specified in SPA.GEN.105, and shall demonstrate compliance with the requirements of this Subpart.
- (c) The operator shall, prior to performing operations from a Member State other than the Member State that issued the approval under (a), inform the competent authorities in both Member States of the intended operation.

GM1 SPA.HOFO.105(c) Approval for offshore operations

The requirement to inform both Member States (MSs) allows the MSs to mutually decide on how best to exercise their obligations in accordance with ARO.GEN.300(d) and (e) when operations are intended to be performed in a MS other than the MS issuing the approval for offshore operations.

SPA.HOFO.110 Operating procedures

- (a) The operator shall, as part of its safety management process, mitigate and minimise risks and hazards specific to helicopter offshore operations. The operator shall specify in the operations manual the:
- (1) selection, composition and training of crews;
 - (2) duties and responsibilities of crew members and other involved personnel;
 - (3) required equipment and dispatch criteria; and
 - (4) operating procedures and minima, such that normal and likely abnormal operations are described and adequately mitigated.
- (b) The operator shall ensure that:
- (1) an operational flight plan is prepared prior to each flight;
 - (2) the passenger safety briefing also includes any specific information on offshore related items and is provided prior to boarding the helicopter;
 - (3) each member of the flight crew wears an approved survival suit:
 - (i) when the weather report or forecasts available to the pilot-in-command/commander indicate that the sea temperature will be less than plus 10°C during the flight; or
 - (ii) when the estimated rescue time exceeds the calculated survival time; or
 - (iii) when the flight is planned to be conducted at night in a hostile environment;
 - (4) where established, the offshore route structure provided by the appropriate ATS is followed;
 - (5) pilots make optimum use of the automatic flight control systems (AFCS) throughout the flight;
 - (6) specific offshore approach profiles are established, including stable approach parameters and the corrective action to be taken if an approach becomes unstable;
 - (7) for multi-pilot operations, procedures are in place for a member of the flight crew to monitor the flight instruments during an offshore flight, especially during approach or departure, to ensure that a safe flight path is maintained;
 - (8) the flight crew takes immediate and appropriate action when a height alert is activated;
 - (9) procedures are in place to require the emergency flotation systems to be armed, when safe to do so, for all overwater arrivals and departures; and
 - (10) operations are conducted in accordance with any restriction on the routes or the areas of operation specified by the competent authority or the appropriate authority responsible for the airspace.

AMC1 SPA.HOFO.110(a) Operating procedures**RISK ASSESSMENT**

The operator's risk assessment should include, but not be limited to, the following hazards:

- (a) collision with offshore installations, vessels and floating structures;
- (b) collision with wind turbines;

- (c) collision with skysails;
- (d) collision during low-level instrument meteorological conditions (IMC) operations;
- (e) collision with obstacles adjacent to helidecks;
- (f) collision with surface/water;
- (g) IMC or night offshore approaches;
- (h) loss of control during operations to small or moving offshore locations;
- (i) operations to unattended helidecks; and
- (j) weather and/or sea conditions that could either cause an accident or exacerbate its consequences.

AMC1 SPA.HOFO.110(b)(1) Operating procedures

OPERATIONAL FLIGHT PLAN

The operational flight plan should contain at least the items listed in AMC1 CAT.OP.MPA.175(a) Flight preparation.

AMC1 SPA.HOFO.110(b)(2) Operating procedures

PASSENGER BRIEFING

The following aspects applicable to the helicopter used should be presented and demonstrated to the passengers by audio-visual electronic means (video, DVD or similar), or the passengers should be informed about them by a crew member prior to boarding the aircraft:

- (a) the use of the life jackets and where they are stowed if not in use;
- (b) the proper use of survival suits, including briefing on the need to have suits fully zipped with, if applicable, hoods and gloves on, during take-off and landing or when otherwise advised by the pilot-in-command/commander;
- (c) the proper use of emergency breathing equipment;
- (d) the location and operation of the emergency exits;
- (e) life raft deployment and boarding;
- (f) deployment of all survival equipment; and
- (g) boarding and disembarkation instructions.

When operating in a non-hostile environment, the operator may omit items related to equipment that is not required.

AMC1.1 SPA.HOFO.110(b)(2) Operating procedures

PASSENGER BRIEFING

This AMC is applicable to passengers who require more knowledge of the operational concept, such as sea pilots and support personnel for offshore wind turbines.

The operator may replace the passenger briefing as set out in AMC1 SPA.HOFO.110(b)(2) with a passenger training and checking programme provided that:

- the operator ensures that the passenger is appropriately trained and qualified on the helicopter types on which they are to be carried;
- the operator defines the training and checking programme for each helicopter type, covering all safety and emergency procedures for a given helicopter type, and including practical training;
- the passenger has received the above training within the last 12 calendar months; and
- the passenger has flown on the helicopter type within the last 90 days.

AMC1 SPA.HOFO.110(b)(5) Operating procedures**AUTOMATIC FLIGHT CONTROL SYSTEM (AFCS)**

To ensure competence in manual handling of the helicopter, the operator should provide instructions to the flight crew in the operations manual (OM) under which circumstances the helicopter may be operated in lower modes of automation. Particular emphasis should be given to flight in instrument meteorological conditions (IMC) and instrument approaches.

GM1 SPA.HOFO.110(b)(9) Operating Procedures

Emergency flotation systems (EFSs) cannot always be armed safely before the approach when a speed limitation needs to be complied with. In such case, the EFS should be armed as soon as safe to do so.

SPA.HOFO.115 Use of offshore locations

The operator shall only use offshore locations that are suitable in relation to size and mass of the type of helicopter and to the operations concerned.

AMC1 SPA.HOFO.115 Use of offshore locations

GENERAL

- (a) The operations manual (OM) relating to the specific usage of offshore helicopter landing areas (Part C for CAT operators) should contain, or make reference to, a directory of helidecks (helideck directory (HD)) intended to be used by the operator. The directory should provide details of helideck limitations and a pictorial representation of each offshore location and its helicopter landing area, recording all necessary information of a permanent nature and using a standardised template. The HD entries should show, and be amended as necessary, the most recent status of each helideck concerning non-compliance with applicable national standards, limitations, warnings, cautions or other comments of operational importance. An example of a typical template is shown in Figure 1 of GM1 SPA.HOFO.115 below.
- (b) In order to ensure that the safety of flights is not compromised, the operator should obtain relevant information and details in order to compile the HD, as well as the pictorial representation from the owner/operator of the offshore helicopter landing area.
- (c) If more than one name for the offshore location exists, the common name painted on the surface of the landing area should be listed, but other names should also be included in the HD (e.g. radio call sign, if different). After renaming an offshore location, the old name should also be included in the HD for the following 6 months.
- (d) Any limitations associated with an offshore location should be included in the HD. With complex installation arrangements, including combinations of installations/vessels (e.g. combined operations), a separate listing in the HD, accompanied by diagrams/pictures, where necessary, may be required.
- (e) Each offshore helicopter landing area should be inspected and assessed based on limitations, warnings, instructions and restrictions, in order to determine its acceptability with respect to the following as a minimum:
- (1) The physical characteristics of the landing area, including size, load-bearing capability and the appropriate 'D' and 't' values.

Note 1: 'D' is the overall length of the helicopter from the most forward position of the main rotor tip to the most rearward position of the tail rotor tip plane path, or rearmost extension of the fuselage in the case of 'Fenestron' or 'NOTAR' tails.

Note 2: 't' is the maximum allowable mass in tonnes.
 - (2) The preservation of obstacle-protected surfaces (an essential safeguard for all flights). These surfaces are:
 - (i) the minimum 210° obstacle-free surface (OFS) above helideck level;
 - (ii) the 150° limited-obstacle surface (LOS) above helideck level; and
 - (iii) the minimum 180° falling '5:1' gradient with respect to significant obstacles below helideck level.

If these sectors/surfaces are infringed, even on a temporary basis, and/or if an adjacent installation or vessel infringes the obstacle-protected surfaces related to the landing area, an assessment should be made to determine whether it is necessary to impose operating limitations and/or restrictions to mitigate any non-compliance with the criteria.

(3) Marking and lighting:

- (i) for operations at night, adequate illumination of the perimeter of the landing area, using perimeter lighting that meets national requirements;
- (ii) for operations at night, adequate illumination of the location of the touchdown marking by use of a lit touchdown/positioning marking and lit helideck identification marking that meet national requirements;
- (iii) status lights (for night and day operations, indicating the status of the helicopter landing area, e.g. a red flashing light indicates 'landing area unsafe: do not land') meeting national requirements;
- (iv) dominant-obstacle paint schemes and lighting;
- (v) condition of helideck markings; and
- (vi) adequacy of general installation and structure lighting.

Any limitations with respect to non-compliance of lighting arrangements may require the HD to be annotated 'daylight only operations'.

(4) Deck surface:

- (i) assessment of surface friction;
- (ii) adequacy and condition of helideck net (where provided);
- (iii) 'fit for purpose' drainage system;
- (iv) deck edge safety netting or shelving;
- (v) a system of tie-down points that is adequate for the range of helicopters in use; and
- (vi) procedures to ensure that the surface is kept clean of all contaminants, e.g. bird guano, sea spray, snow and ice.

(5) Environment:

- (i) foreign-object damage;
- (ii) an assessment of physical turbulence generators, e.g. structure-induced turbulence due to clad derrick;
- (iii) bird control measures;
- (iv) air flow degradation due to gas turbine exhaust emissions (turbulence and thermal effects), flares (thermal effects) or cold gas vents (unburned flammable gas); and
- (v) adjacent offshore installations may need to be included in the environmental assessment.

To assess for potential adverse environmental effects, as described in (ii), (iv) and (v) above, an offshore location should be subject to appropriate studies, e.g. wind tunnel testing and/or computational fluid dynamics (CFD) analysis.

(6) Rescue and firefighting:

- (i) systems for delivery of firefighting media to the landing area, e.g. deck integrated firefighting system (DIFFS);
 - (ii) delivery of primary media types, assumed critical area, application rate and duration;
 - (iii) deliveries of complementary agent(s) and media types, capacity and discharge;
 - (iv) personal protective equipment (PPE); and
 - (v) rescue equipment and crash box/cabinet.
- (7) Communication and navigation (Com/Nav):
- (i) aeronautical radio(s);
 - (ii) radio-telephone (R/T) call sign to match the offshore location name with the side identification that should be simple and unique; and
 - (iii) radio log.
- (8) Fuelling facilities:
- in accordance with the relevant national guidance and legislation.
- (9) Additional operational and handling equipment:
- (i) windsock;
 - (ii) meteorological information, including wind, pressure, air temperature, and dew point temperature, and equipment recording and displaying mean wind (10-min wind) and gusts;
 - (iii) helideck motion recording and reporting system, where applicable;
 - (iv) passenger briefing system;
 - (v) chocks;
 - (vi) tie-down strops/ropes;
 - (vii) weighing scales;
 - (viii) a suitable power source for starting helicopters (e.g. ground power unit (GPU)), where applicable; and
 - (ix) equipment for clearing the landing area of snow, ice and other contaminants.
- (10) Personnel:
- trained helicopter-landing-area staff (e.g. helicopter landing officer/helicopter deck assistant and firefighters, etc.); persons required to assess local weather conditions or communicate with the helicopter by radio-telephony should be appropriately qualified.
- (f) The HD entry for each offshore location should be completed and kept up to date, using the template and reflecting the information and details described in (e) above. The template should contain at least the following (GM1 SPA.HOFO.115 below is provided as an example):
- (1) details:
- (i) name of offshore location;
 - (ii) R/T call sign;
 - (iii) helicopter landing area identification marking;
 - (iv) side panel identification marking;

- (v) landing area elevation;
 - (vi) maximum installation/vessel height;
 - (vii) helideck size and/or 'D' value;
 - (viii) type of offshore location:
 - (A) fixed, permanently manned installation;
 - (B) fixed, normally unattended installation;
 - (C) vessel type (e.g. diving support vessel, tanker, etc.);
 - (D) semi-submersible, mobile, offshore drilling unit;
 - (E) jack-up, mobile, offshore drilling unit;
 - (F) floating production, storage and offloading (FPSO);
 - (ix) name of owner/operator;
 - (x) geographical position, where appropriate;
 - (xi) Com/Nav frequencies and identification;
 - (xii) general drawing of the offshore location that shows the helicopter landing area with annotations indicating location of derrick, masts, cranes, flare stack, turbine and gas exhausts, side identification panels, windsock, etc.;
 - (xiii) plan view drawing, and chart orientation from the general drawing to show the above; the plan view should also show the 210-degree sector orientation in degrees true;
 - (xiv) type of fuelling:
 - (A) pressure and gravity;
 - (B) pressure only;
 - (C) gravity only; and
 - (D) none;
 - (xv) type and nature of firefighting equipment;
 - (xvi) availability of GPU;
 - (xvii) deck heading;
 - (xviii) 't' value ;
 - (xix) status light system (Yes/No); and
 - (xx) revision publication date or number; and
- (2) one or more diagrams/photographs, and any other suitable guidance to assist pilots.
- (g) For offshore locations for which there is incomplete information, 'restricted' usage based on the information available may be considered by the operator, subject to risk assessment prior to the first helicopter visit. During subsequent operations, and before any restriction on usage is lifted, information should be gathered and the following should apply:
- (1) pictorial (static) representation:

- (i) template blanks (GM1 SPA.HOFO.115 is provided as an example) should be available to be filled in during flight preparation on the basis of the information given by the offshore location owner/operator and of flight crew observations;
 - (ii) where possible, suitably annotated photographs may be used until the HD entry and template have been completed;
 - (iii) until the HD entry and template have been completed, conservative operational restrictions (e.g. performance, routing, etc.) may be applied;
 - (iv) any previous inspection reports should be obtained and reviewed by the operator; and
 - (v) an inspection of the offshore helicopter landing area should be carried out to verify the content of the completed HD entry and template; once found suitable, the landing area may be considered authorised for use by the operator; and
- (2) with reference to the above, the HD entry should contain at least the following:
- (i) HD revision date or number;
 - (ii) generic list of helideck motion limitations;
 - (iii) name of offshore location;
 - (iv) helideck size and/or 'D' value and 't' value; and
 - (v) limitations, warnings, instructions and restrictions.

GM1 SPA.HOFO.115 Use of offshore locations

Figure 1 — Example of a helicopter landing area template

Operator		10-1	Revision date	
Installation/vessel name		Position	(N/S XXX)	(E/W XXX)
Deck height	Installation height	Highest obstacle within 5 nm	Deck heading	Deck ident
(XXX ft)	(XXX ft)			
AIMS/ICAO code	Radio	Radio	Deck category	Side ident
			(1/2/3)	
Deck size (m)	T value (XXX kg)	Cleared for (above D or t values)	Installation type	Operator
		(Helicopter type xxx)	(Fixed/semi/etc.)	
Fuel	Ground power	Inspection date	Inspected by	Next due
(Press/gravity/no)	(AC/DC/no)			

APPLICABLE FROM 1 JULY 2018

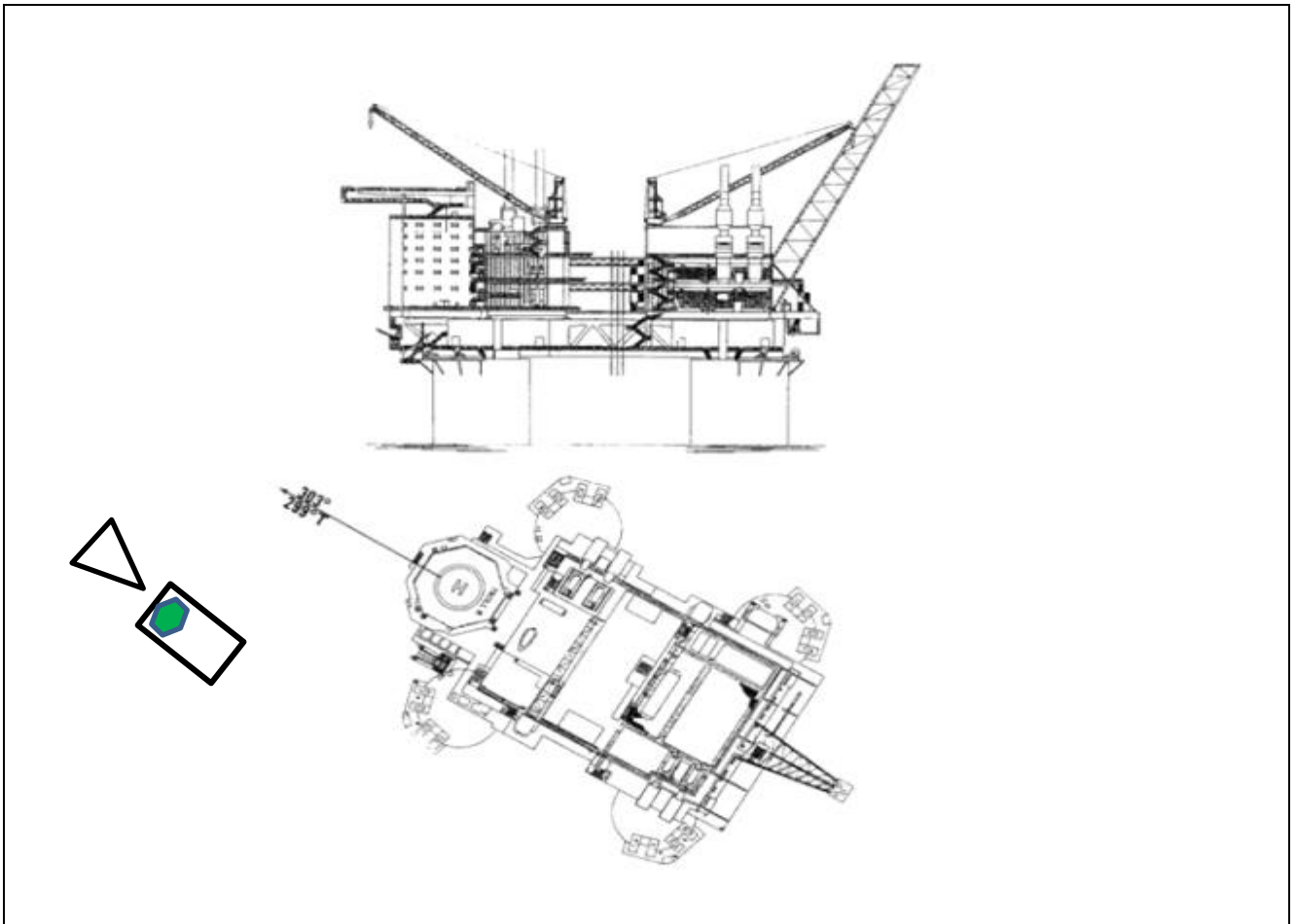

Wind direction	Wind speed	Limitations
(All) (000–050)	(All) (> 30)	(Performance requirements) (Table 2 etc.)
5:1 non-compliant obstacles		
Additional information		

Figure 2 — Example of a helicopter landing area template

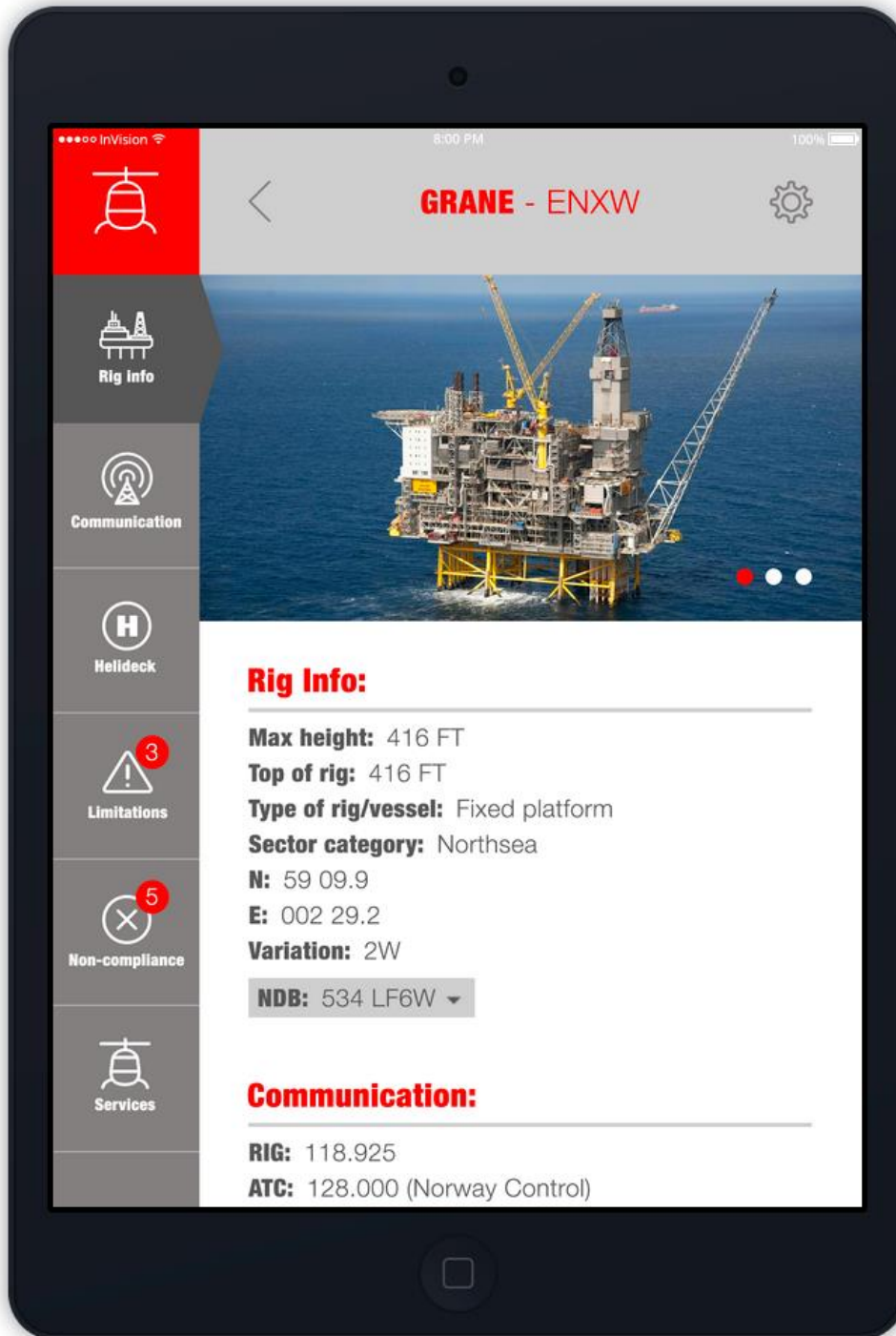

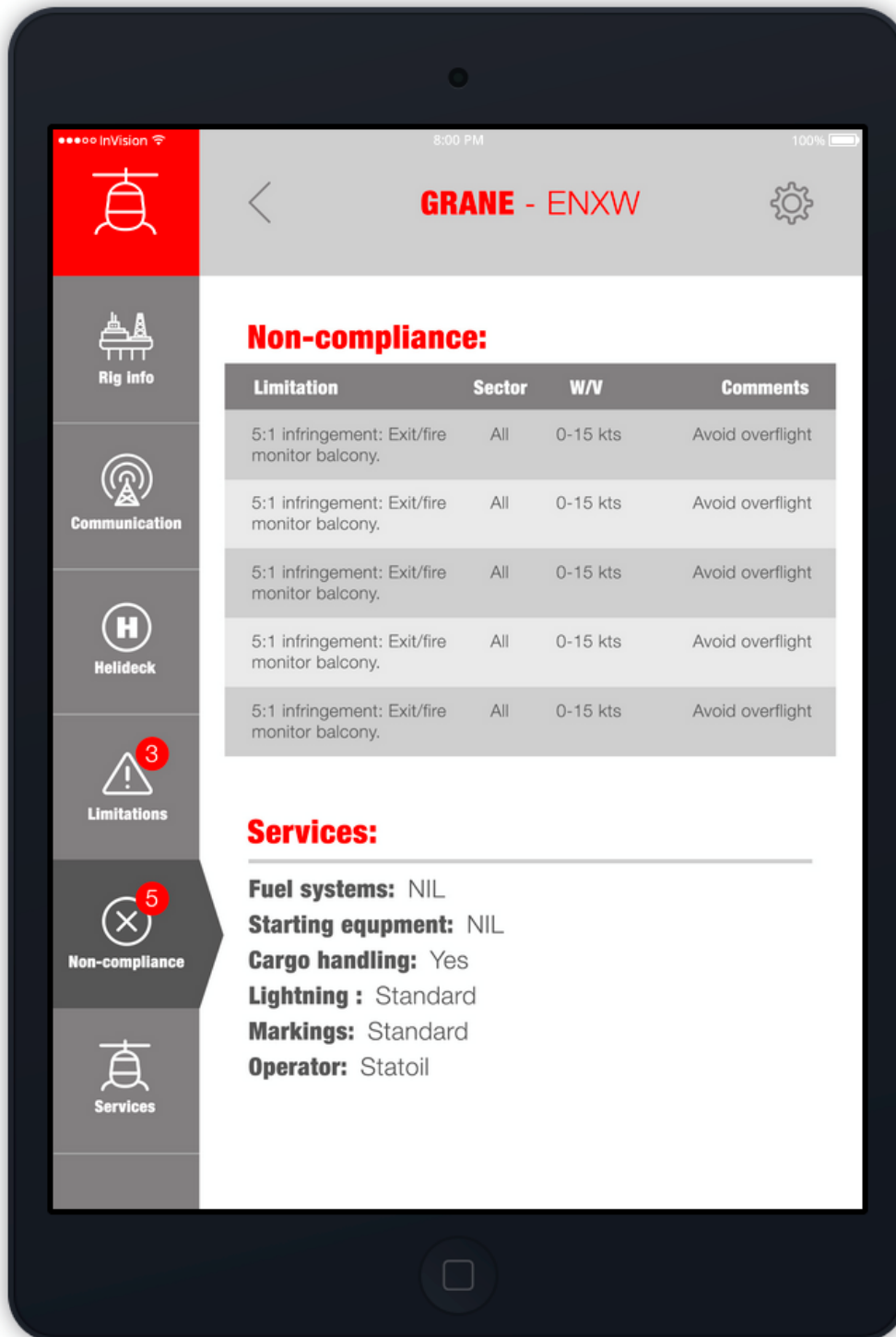

GM2 SPA.HOFO.115 Use of offshore locations

Operators should use available standards and regulations provided for operations to offshore locations such as those contained in United Kingdom Civil Aviation Authority (UK CAA) CAP 437 ‘Standards for Offshore Helicopter Landing Areas’, Norwegian Civil Aviation Regulation BSL D 5-1 or similar national documentation, or ICAO Annex 14, Vol II ‘Heliports’.

SPA.HOFO.120 Selection of aerodromes and operating sites

- (a) *Onshore destination alternate aerodrome.* Notwithstanding CAT.OP.MPA.181, NCC.OP.152, and SPO.OP.151, the pilot-in command/commander does not need to specify a destination alternate aerodrome in the operational flight plan when conducting flights from an offshore location to a land aerodrome if either:
- (1) the destination aerodrome is defined as a coastal aerodrome, or
 - (2) the following criteria are met:
 - (i) the destination aerodrome has a published instrument approach;
 - (ii) the flight time is less than 3 hours; and
 - (iii) the published weather forecast valid from 1 hour prior, and 1 hour subsequent to the expected landing time specifies that:
 - (A) the cloud base is at least 700 feet above the minima associated with the instrument approach, or 1 000 feet above the destination aerodrome, whichever is the higher; and
 - (B) visibility is at least 2 500 meters.
- (b) *Offshore destination alternate helideck.* The operator may select an offshore destination alternate helideck when all of the following criteria are met:
- (1) An offshore destination alternate helideck shall be used only after the point of no return (PNR) and when an onshore destination alternative aerodrome is not geographically available. Prior to the PNR, an onshore destination alternate aerodrome shall be used.
 - (2) One engine inoperative (OEI) landing capability shall be attainable at the offshore destination alternate helideck.
 - (3) To the extent possible, helideck availability shall be guaranteed prior to PNR. The dimensions, configuration and obstacle clearance of individual helidecks or other sites shall be suitable for its use as an alternate helideck by each helicopter type intended to be used.
 - (4) Weather minima shall be established taking into account the accuracy and reliability of meteorological information.
 - (5) The MEL shall contain specific provisions for this type of operation.
 - (6) An offshore destination alternate helideck shall only be selected if the operator has established a procedure in the operations manual.

AMC1 SPA.HOFO.120 Selection of aerodromes and operating sites**COASTAL AERODROME**

- (a) Any alleviation from the requirement to select an alternate aerodrome for a flight to a coastal aerodrome under instrument flight rules (IFR) routing from offshore should be based on an individual safety risk assessment.
- (b) The following should be taken into account:
- (1) suitability of the weather based on the landing forecast for the destination;
 - (2) the fuel required to meet the IFR requirements of CAT.OP.MPA.150, NCC.OP.131 or SPO.OP.131 except for the alternate fuel;

- (3) where the destination coastal aerodrome is not directly on the coast, it should be:
 - (i) within a distance that with the fuel specified in (b)(2), the helicopter is able, at any time after crossing the coastline, to return to the coast, descend safely, carry out an approach under visual flight rules (VFR) and land, with the VFR fuel reserves intact;
 - (ii) within 5 nm of the coastline; and
 - (iii) geographically sited so that the helicopter is able, within the rules of the air and within the landing forecast:
 - (A) to proceed inbound from the coast at 500-ft above ground level (AGL), and carry out an approach and landing under VFR; or
 - (B) to proceed inbound from the coast on an agreed route, and carry out an approach and landing under VFR;
- (4) procedures for coastal aerodromes should be based on a landing forecast no worse than:
 - (i) by day, a cloud base of ≥ 400 ft above descent height (DH)/minimum descent height (MDH), and a visibility of 4 km, or, if descent over the sea is intended, a cloud base of 600 ft and a visibility of 4 km; or
 - (ii) by night, a cloud base of 1 000 ft and a visibility of 5 km;
- (5) the descent to establish visual contact with the surface should take place over the sea or as part of the instrument approach;
- (6) routings and procedures for coastal aerodromes nominated as such should be included in the operations manual (OM) (Part C for CAT operators);
- (7) the minimum equipment list (MEL) should reflect the requirement for airborne radar and radio altimeter for this type of operation; and
- (8) operational limitations for each coastal aerodrome should be specified in the OM.

AMC2 SPA.HOFO.120 Selection of aerodromes and operating sites

OFFSHORE DESTINATION ALTERNATE AERODROME

'Aerodrome' is referred to as 'helideck' in this AMC.

(a) Offshore destination alternate helideck landing environment

The landing environment at an offshore location proposed for use as an offshore destination alternate helideck should be pre-surveyed, together with the physical characteristics, such as the effect of wind direction and strength, as well as of turbulence established. This information, which should be available to the pilot-in-command/commander both at the planning stage and in-flight, should be published in an appropriate form in the operations manual (OM) (including the orientation of the helideck) so that the suitability of the alternate helideck can be assessed. This helideck should meet the criteria for size and obstacle clearance appropriate to the performance requirements of the type of helicopter concerned.

(b) Performance considerations

The use of an offshore destination alternate helideck should be restricted to helicopters that can achieve one engine inoperative (OEI) in ground effect (IGE) hover at an appropriate power rating above the helideck at the offshore location. Where the surface of the helideck or prevailing conditions (especially wind velocity) precludes an OEI IGE, OEI out-of-ground effect (OGE) hover

performance at an appropriate power rating should be used to compute the landing mass. The landing mass should be calculated based on graphs provided in the operations manual (OM) (Part B for CAT operators). When this landing mass is computed, due account should be taken of helicopter configuration, environmental conditions and the operation of systems that have an adverse effect on performance. The planned landing mass of the helicopter, including crew, passengers, baggage, cargo plus 30-min final reserve fuel (FRF), should not exceed the OEI landing mass of the helicopter at the time of approach to the offshore destination alternate.

(c) Weather considerations

(1) Meteorological observations

When the use of an offshore destination alternate helideck is planned, the meteorological observations, both at the offshore destination and the alternate helideck, should be made by an observer acceptable to the authority responsible for the provision of meteorological services. Automatic meteorological-observation stations may be used.

(2) Weather minima

When the use of an offshore destination alternate helideck is planned, the operator should neither select an offshore location as destination nor as alternate helideck unless the weather forecasts for the two offshore locations indicate that during a period commencing 1 h before and ending 1 h after the expected time of arrival at the destination and the alternate helideck, the weather conditions will be at or above the planning minima shown in the following table:

Table 1 — Planning minima

Planning minima		
	Day	Night
Cloud base	600 ft	800 ft
Visibility	4 km	5 km

(3) Conditions of fog

To use an offshore destination alternate helideck, it should be ensured that fog is not forecast or present within 60 nm of the destination helideck and alternate helideck during the period commencing 1 h before and ending 1 h after the expected time of arrival at the offshore destination or alternate helideck.

(d) Actions at point of no return

Before passing the point of no return, which should not be more than 30 min from the destination, the following actions should have been completed:

- (1) confirmation that navigation to the offshore destination and offshore destination alternate helideck can be assured;
- (2) radio contact with the offshore destination and offshore destination alternate helideck (or master station) has been established;
- (3) the landing forecast at the offshore destination and offshore destination alternate helideck have been obtained and confirmed to be at or above the required minima;
- (4) the requirements for OEI landing (see (b) above) have been checked in the light of the latest reported weather conditions to ensure that they can be met; and

- (5) to the extent possible, having regard to information on the current and forecast use of the offshore alternate helideck and on prevailing conditions, the availability of the helideck on the offshore location intended as destination alternate helideck should be guaranteed by the duty holder (the rig operator in the case of fixed installations, and the owner in the case of mobile ones) until the landing at the destination, or the offshore destination alternate helideck, has been achieved or until offshore shuttling has been completed.

SPA.HOFO.125 Airborne radar approaches (ARAs) to offshore locations — CAT operations

- (a) A commercial air transport (CAT) operator shall establish operational procedures and ensure that ARAs are only flown if:
 - (1) the helicopter is equipped with a radar that is capable of providing information regarding the obstacle environment; and
 - (2) either:
 - (i) the minimum descent height (MDH) is determined from a radio altimeter; or
 - (ii) the minimum descent altitude (MDA) plus an adequate margin is applied.
- (b) ARAs to rigs or vessels in transit shall be flown as multi-pilot operations.
- (c) The decision range shall provide adequate obstacle clearance in the missed approach from any destination for which an ARA is planned.
- (d) The approach shall only be continued beyond decision range or below the minimum descent altitude/height (MDA/H) when visual reference to the destination has been established.
- (e) For single-pilot CAT operations, appropriate increments shall be added to the MDA/H and decision range.
- (f) When an ARA is flown to a non-moving offshore location (i.e. fixed installation or moored vessel) and a reliable GPS position for the location is available in the navigation system, the GPS/area navigation system shall be used to enhance the safety of the ARA.

AMC1 SPA.HOFO.125 Airborne radar approach (ARA) to offshore locations

Note: alternative approach procedures using original equipment manufacturer (OEM)-certified approach systems are not covered by this AMC.

GENERAL

- (a) Before commencing the final approach, the pilot-in-command/commander should ensure that a clear path exists on the radar screen for the final and missed approach segments. If lateral clearance from any obstacle will be less than 1 nm, the pilot-in-command/commander should:
 - (1) approach to a nearby target structure and thereafter proceed visually to the destination structure; or
 - (2) make the approach from another direction leading to a circling manoeuvre.
- (b) The cloud ceiling should be sufficiently clear above the helideck to permit a safe landing.
- (c) Minimum descent height (MDH) should not be less than 50 ft above the elevation of the helideck:
 - (1) the MDH for an airborne radar approach should not be lower than:
 - (i) 200 ft by day; or
 - (ii) 300 ft by night; and
 - (2) the MDH for an approach leading to a circling manoeuvre should not be lower than:
 - (i) 300 ft by day; or
 - (ii) 500 ft by night.
- (d) Minimum descent altitude (MDA) may only be used if the radio altimeter is unserviceable. The MDA should be a minimum of the MDH + 200 ft, and be based on a calibrated barometer at the

- destination or on the lowest forecast barometric pressure adjusted to sea level (QNH) for the region.
- (e) The decision range should not be less than 0.75 nm.
 - (f) The MDA/MDH for a single-pilot ARA should be 100 ft higher than that calculated in accordance with (c) and (d) above. The decision range should not be less than 1 nm.
 - (g) For approaches to non-moving offshore locations, the maximum range discrepancy between the global navigation satellite system (GNSS) and the weather radar display should not be greater than 0.3 nm at any point between the final approach fix (FAF) at 4 nm from the offshore location and the offset initiation point (OIP) at 1.5 nm from the offshore location.
 - (h) For approaches to non-moving offshore locations, the maximum bearing discrepancy between the GNSS and the weather radar display should not be greater than 10° at the FAF at 4 nm from the offshore location.

GM1 SPA.HOFO.125 Airborne radar approach (ARA) to offshore locations

GENERAL

- (a) General
 - (1) The helicopter ARA procedure may have as many as five separate segments: the arrival, initial, intermediate, final approach, and missed approach segment. In addition, the specifications of the circling manoeuvre to a landing under visual conditions should be considered. The individual approach segments can begin and end at designated fixes. However, the segments of an ARA may often begin at specified points where no fixes are available.
 - (2) The fixes, or points, are named to coincide with the beginning of the associated segment. For example, the intermediate segment begins at the intermediate fix (IF) and ends at the final approach fix (FAF). Where no fix is available or appropriate, the segments begin and end at specified points; for example, at the intermediate point (IP) and final approach point (FAP). The order in which the segments are discussed in this GM is the order in which the pilot would fly them in a complete procedure: that is, from the arrival through the initial and intermediate to the final approach and, if necessary, to the missed approach.
 - (3) Only those segments that are required by local conditions applying at the time of the approach need to be included in a procedure. In constructing the procedure, the final approach track, which should be orientated so as to be substantially into the wind, should be identified first as it is the least flexible and most critical of all the segments. When the origin and the orientation of the final approach have been determined, the other necessary segments should be integrated with it to produce an orderly manoeuvring pattern that does not generate an unacceptably high workload for the flight crew.
 - (4) Where an ARA is conducted to a non-moving offshore location (i.e. fixed installation or moored vessel), and a reliable global navigation satellite system (GNSS) position for the location is available, the GNSS/area navigation system should be used to enhance the safety of the ARA. This is achieved by using the GNSS/area navigation system to navigate the helicopter onto, and maintain, the final approach track, and by using the GNSS range and bearing information to cross-check the position of the offshore location on the weather radar display.

- (5) Examples of ARA procedures, as well as vertical profile and missed approach procedures, are contained in Figures 1 and 2 below.

(b) Obstacle environment

- (1) Each segment of the ARA is located in an overwater area that has a flat surface at sea level. However, due to the passage of large vessels which are not required to notify their presence, the exact obstacle environment cannot be determined. As the largest vessels and structures are known to reach elevations exceeding 500 ft above mean sea level (AMSL), the uncontrolled offshore obstacle environment applying to the arrival, initial and intermediate approach segments can reasonably be assumed to be capable of reaching to at least 500 ft AMSL. Nevertheless, in the case of the final approach and missed approach segments, specific areas are involved within which no radar returns are allowed. In these areas, the height of wave crests, and the possibility that small obstacles may be present that are not visible on radar, results in an uncontrolled surface environment that extends to an elevation of 50 ft AMSL.
- (2) Information about movable obstacles should be requested from the arrival destination or adjacent installations.

Under normal circumstances, the relationship between the approach procedure and the obstacle environment is governed by the concept that vertical separation is very easy to apply during the arrival, initial and intermediate segments, while horizontal separation, which is much more difficult to guarantee in an uncontrolled environment, is applied only in the final and missed approach segments.

(c) Arrival segment

The arrival segment commences at the last en-route navigation fix, where the aircraft leaves the helicopter route, and it ends either at the initial approach fix (IAF) or, if no course reversal or similar manoeuvre is required, it ends at the IF. Standard en-route obstacle clearance criteria should be applied to the arrival segment.

(d) Initial approach segment

The initial approach segment is only required if the intermediate approach track cannot be joined directly. Most approaches will be flown direct to a point close to the IF, and then on to the final approach track, using GNSS/area navigation guidance. The segment commences at the IAF, and on completion of the manoeuvre, it ends at the IP. The minimum obstacle clearance (MOC) assigned to the initial approach segment is 1 000 ft.

(e) Intermediate approach segment

The intermediate approach segment commences at the IP, or in the case of straight-in approaches, where there is no initial approach segment, it commences at the IF. The segment ends at the FAP and should not be less than 2 nm in length. The purpose of the intermediate segment is to align the helicopter with the final approach track and prepare it for the final approach. During the intermediate segment, the helicopter should be lined up with the final approach track, the speed should be stabilised, the destination should be identified on the radar, and the final approach and missed approach areas should be identified and verified to be clear of radar returns. The MOC assigned to the intermediate segment is 500 ft.

(f) Final approach segment

- (1) The final approach segment commences at the FAP and ends at the missed approach point (MAPt). The final approach area, which should be identified on radar, takes the form of a

corridor between the FAP and the radar return of the destination. This corridor should not be less than 2 nm wide so that the projected track of the helicopter does not pass closer than 1 nm to the obstacles lying outside the area.

- (2) On passing the FAP, the helicopter will descend below the intermediate approach altitude and follow a descent gradient which should not be steeper than 6.5 %. At this stage, vertical separation from the offshore obstacle environment will be lost. However, within the final approach area, the MDA/MDH will provide separation from the surface environment. Descent from 1 000 ft AMSL to 200 ft AMSL at a constant 6.5 % gradient will involve a horizontal distance of 2 nm. In order to follow the guideline that the procedure should not generate an unacceptably high workload for the flight crew, the required actions of levelling off at MDH, changing heading at the offset initiation point (OIP), and turning away at the MAPt, should not be planned to occur at the same time from the destination.
 - (3) During the final approach, compensation for drift should be applied, and the heading which, if maintained, would take the helicopter directly to the destination should be identified. It follows that at an OIP located at a range of 1.5 nm, a heading change of 10° is likely to result in a track offset of 15° at 1 nm, and the extended centre line of the new track can be expected to have a mean position approximately 300–400 m to one side of the destination structure. The safety margin built into the 0.75-nm decision range (DR) is dependent upon the rate of closure with the destination. Although the airspeed should be in the range of 60–90 KIAS during the final approach, the ground speed, after due allowance for wind velocity, should not be greater than 70 kt.
- (g) Missed approach segment
- (1) The missed approach segment commences at the MAPt and ends when the helicopter reaches the minimum en route altitude. The missed approach manoeuvre is a ‘turning missed approach’ which should be of not less than 30° and should not, normally, be greater than 45°. A turn away of more than 45° does not reduce the collision risk factor any further nor does it permit a closer DR. However, turns of more than 45° may increase the risk of pilot disorientation, and by inhibiting the rate of climb (especially in the case of an OEI missed approach procedure), may keep the helicopter at an extremely low level for longer than it is desirable.
 - (2) The missed approach area to be used should be identified and verified as a clear area on the radar screen during the intermediate approach segment. The base of the missed approach area is a sloping surface at 2.5 % gradient starting from MDH at the MAPt. The concept is that a helicopter executing a turning missed approach will be protected by the horizontal boundaries of the missed approach area until vertical separation of more than 130 ft is achieved between the base of the area and the offshore obstacle environment of 500 ft AMSL that prevails outside the area.
 - (3) A missed approach area, taking the form of a 45° sector orientated left or right of the final approach track, originating from a point 5 nm short of the destination, and terminating on an arc 3 nm beyond the destination, should normally satisfy the specifications of a 30° turning missed approach.
- (h) Required visual reference
- The visual reference required is that the destination should be in view in order to be able to carry out a safe landing.
- (i) Radar equipment

During the ARA procedure, colour mapping radar equipment with a 120° sector scan and a 2.5-nm range scale selected may result in dynamic errors of the following order:

- (1) bearing/tracking error of $\pm 4.5^\circ$ with 95 % accuracy;
- (2) mean ranging error of 250 m; or
- (3) random ranging error of ± 250 m with 95 % accuracy.

Figure 1 — Horizontal profile

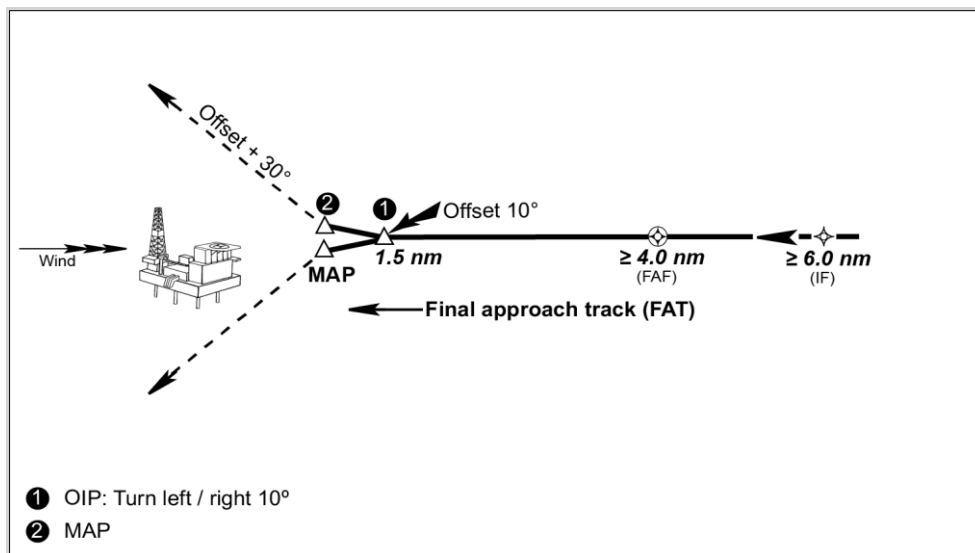
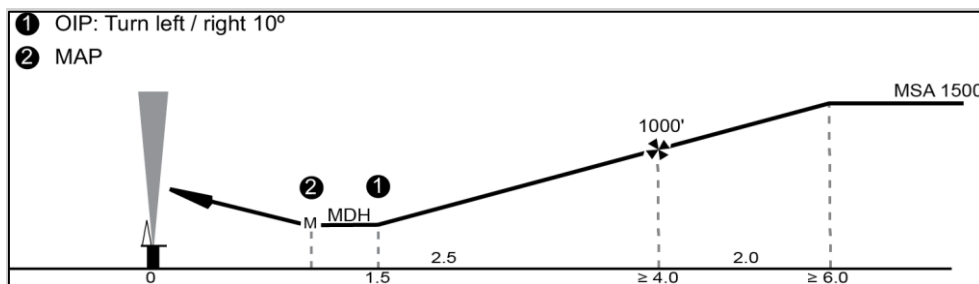

Figure 2 — Vertical profile



GM2 SPA.HOFO.125 Airborne radar approach (ARA) to offshore locations

GLOBAL NAVIGATION SATELLITE SYSTEM (GNSS)/AREA NAVIGATION SYSTEM

Where an ARA is conducted to a non-moving offshore location (i.e. fixed installation or moored vessel), and the GNSS/area navigation system is used to enhance the safety of the ARA, the following procedure or equivalent should be applied:

- (a) selection from the area navigation system database or manual entry of the offshore location;
- (b) manual entry of the final approach fix (FAF) or intermediate fix (IF), as a range of and bearing from the offshore location;
- (c) operation of the GNSS equipment in terminal mode;

- (d) comparison of weather radar and GNSS range and bearing data to cross-check the position of the offshore location;
- (e) use of GNSS guidance to guide the aircraft onto the final approach track during the initial or intermediate approach segments;
- (f) use of GNSS guidance from the FAF towards the offset initiation point (OIP) during the final approach segment to establish the helicopter on the correct approach track and, hence, heading;
- (g) transition from GNSS guidance to navigation based on headings once the track is stabilised and before reaching OIP;
- (h) use of GNSS range of and bearing to the offshore location during the intermediate and final approach segments to cross-check weather radar information (for correct 'painting' of the destination and, hence, of other obstacles);
- (i) use of GNSS range of the offshore location to enhance confidence in the weather radar determination of arrival at the OIP and MAPt; and
- (j) use of GNSS range of and bearing to the destination to monitor separation from the offshore location.

SPA.HOFO.130 Meteorological conditions

Notwithstanding CAT.OP.MPA.247, NCC.OP.180 and SPO.OP.170, when flying between offshore locations located in class G airspace where the overwater sector is less than 10 NM, VFR flights may be conducted when the limits are at, or better than, the following:

Minima for flying between offshore locations located in class G airspace

	Day		Night	
	Height*	Visibility	Height*	Visibility
Single pilot	300 feet	3 km	500 feet	5 km
Two pilots	300 feet	2 km**	500 feet	5 km***

* The cloud base shall allow flight at the specified height to be below and clear of cloud.

** Helicopters may be operated in flight visibility down to 800 m, provided the destination or an intermediate structure is continuously visible.

*** Helicopters may be operated in flight visibility down to 1 500 m, provided the destination or an intermediate structure is continuously visible.

SPA.HOFO.135 Wind limitations for operations to offshore locations

Operation to an offshore location shall only be performed when the wind speed at the helideck is reported to be not more than 60 knots including gusts.

SPA.HOFO.140 Performance requirements at offshore locations

Helicopters taking off from and landing at offshore locations shall be operated in accordance with the performance requirements of the appropriate Annex according to their type of operation.

AMC1 SPA.HOFO.140 Performance requirements — take-off and landing at offshore locations**FACTORS**

To ensure that the necessary factors are taken into account, operators not conducting CAT operations should use take-off and landing procedures that are appropriate to the circumstances and have been developed in accordance with ORO.MLR.100 in order to minimise the risks of collision with obstacles at the individual offshore location under the prevailing conditions.

SPA.HOFO.145 Flight data monitoring (FDM) system

- (a) When conducting CAT operations with a helicopter equipped with a flight data recorder, the operator shall establish and maintain a FDM system, as part of its integrated management system, by 1 January 2019.
- (b) The FDM system shall be non-punitive and contain adequate safeguards to protect the source(s) of the data.

AMC1 SPA.HOFO.145 Flight data monitoring (FDM) programme

FDM PROGRAMME

Refer to AMC1 ORO.AOC.130.

Note: Appendix 1 to AMC1 ORO.AOC.130 is not valid for helicopters.

GM1 SPA.HOFO.145 Flight data monitoring (FDM) programme

DEFINITION OF AN FDM PROGRAMME

Refer to GM1 ORO.AOC.130, except for the examples that are specific to aeroplane operation.

GM2 SPA.HOFO.145 Flight data monitoring (FDM) programme

FDM

Additional guidance material for the establishment of a FDM programme is found in:

- (a) International Civil Aviation Organization (ICAO) Doc 10000 — Manual on Flight Data Analysis Programmes (FDAP); and
- (b) United Kingdom Civil Aviation Authority (UK CAA) CAP 739 — Flight Data Monitoring.

The following table provides examples of FDM events that may be further developed using operator- and helicopter-specific limits. The table is considered illustrative and non-exhaustive.

Table 1 — Examples of FDM events

Event title/description	Parameters required	Comments
Ground		
Outside air temperature (OAT) high — Operating limits	OAT	To identify when the helicopter is operated at the limits of OAT.
Sloping-ground high-pitch attitude	Pitch attitude, ground switch (similar)	To identify when the helicopter is operated at the slope limits.
Sloping-ground high-roll attitude	Roll attitude, ground switch (similar)	To identify when the helicopter is operated at the slope limits.
Rotor brake on at an excessive number of rotations (main rotor speed) (NR)	Rotor brake discreet, NR	To identify when the rotor brake is applied at too high NR.
Ground taxiing speed — max	Ground speed (GS), ground switch	To identify when the helicopter is

APPLICABLE FROM 1 JULY 2018

	(similar)	ground taxied at high speed (wheeled helicopters only).
Air taxiing speed — max	GS, ground switch (similar), radio altitude (Rad Alt)	To identify when the helicopter is air taxied at high speed.
Excessive power during ground taxiing	Total torque (Tq), ground switch (similar), GS	To identify when excessive power is used during ground taxiing.
Pedal — max left-hand (LH) and right-hand (RH) taxiing	Pedal position, ground switch (similar), GS or NR	To identify when the helicopter flight controls (pedals) are used to excess on the ground. GS or NR to exclude control test prior to rotor start.
Excessive yaw rate on ground during taxiing	Yaw rate, ground switch (similar), or Rad Alt	To identify when the helicopter yaws at a high rate when on the ground.
Yaw rate in hover or on ground	Yaw rate, GS, ground switch (similar)	To identify when the helicopter yaws at a high rate when in a hover.
High lateral acceleration (rapid cornering)	Lateral acceleration, ground switch (similar)	To identify high levels of lateral acceleration, when ground taxiing, that indicate high cornering speed.
High longitudinal acceleration (rapid braking)	Longitudinal acceleration, ground switch (similar)	To identify high levels of longitudinal acceleration, when ground taxiing, that indicate excessive braking.
Cyclic-movement limits during taxiing (pitch or roll)	Cyclic stick position, ground switch (similar), Rad Alt, NR or GS	To identify excessive movement of the rotor disc when running on ground. GS or NR to exclude control test prior to rotor start.
Excessive longitudinal and lateral cyclic rate of movement on ground	Longitudinal cyclic pitch rate, lateral cyclic pitch rate, NR	To detect an excessive rate of movement of cyclic control when on the ground with rotors running.
Lateral cyclic movement — closest to LH and RH rollover	Lateral cyclic position, pedal position, roll attitude, elapsed time, ground switch (similar)	To detect the risk of a helicopter rollover due to an incorrect combination of tail rotor pedal position and lateral cyclic control position when on ground.
Excessive cyclic control with insufficient collective pitch on ground	Collective pitch, longitudinal cyclic pitch, lateral cyclic pitch	To detect an incorrect taxiing technique likely to cause rotor head damage.

APPLICABLE FROM 1 JULY 2018

Inadvertent lift-off	Ground switch (similar), autopilot discreet	To detect inadvertent lifting into hover.
Flight — Take-off and landing		
Day or night landing or take-off	Latitude and Longitude (Lat & Long), local time or UTC	To provide day/night relevance to detected events.
Specific location of landing or take-off	Lat & Long, ground switch (similar), Rad Alt, total Tq	To give contextual information concerning departures and destinations.
Gear extension and retraction — airspeed limit	Indicated airspeed (IAS), gear position	To identify when undercarriage airspeed limitations are breached.
Gear extension & retraction — height limit	Gear position, Rad Alt	To identify when undercarriage altitude limitations are breached.
Heavy landing	Normal/vertical acceleration, ground switch (similar)	To identify when hard/heavy landings take place.
Cabin heater on (take-off and landing)	Cabin heater discreet, ground switch (similar)	To identify use of engine bleed air during periods of high power demand.
High GS prior to touchdown (TD)	GS, Rad Alt, ground switch (similar), elapsed time, latitude, longitude	To assist in the identification of 'quick stop' approaches.
Flight — Speed		
High airspeed — with power	IAS, Tq 1, Tq 2, pressure altitude (Palt), OAT	To identify excessive airspeed in flight.
High airspeed — low altitude	IAS, Rad Alt	To identify excessive airspeed in low-level flight.
Low airspeed at altitude	IAS, Rad Alt	To identify a 'hover out of ground' effect.
Airspeed on departure (< 300 ft)	IAS, ground switch (similar), Rad Alt	To identify shallow departure.
High airspeed — power off	IAS, Tq 1, Tq 2 or one engine inoperative (OEI) discreet, Palt, OAT	To identify limitation exceedance of power-off airspeed.
Downwind flight within 60 sec of take-off	IAS, GS, elapsed time	To detect early downwind turn after take-off.
Downwind flight within 60 sec of landing	IAS, GS, elapsed time	To detect late turn to final shortly before landing.
Flight — Height		
Altitude — max	Palt	To detect flight outside of the published flight envelope.

APPLICABLE FROM 1 JULY 2018

Climb rate — max	Vertical speed (V/S), or Palt, or Rad Alt, Elapsed time	Identification of excessive rates of climb (RoC) can be determined from an indication/rate of change of Palt or Rad Alt.
High rate of descent	V/S	To identify excessive rates of descent (RoD).
High rate of descent (speed or height limit)	V/S, IAS or Rad Alt or elevation	To identify RoD at low level or low speed.
Settling with power (vortex ring)	V/S, IAS, GS, Tq	To detect high-power settling with low speed and with excessive rate of descent.
Minimum altitude in autorotation	NR, total Tq, Rad Alt	To detect late recovery from autorotation.
Low cruising (inertial systems)	GS, V/S, elevation, Lat & Long	To detect an extended low-level flight. Ground speed is less accurate with more false alarms. Lat & Long used for geographical boundaries.
Low cruising (integrated systems)	Rad Alt, elapsed time, Lat & Long, ground switch (similar)	To detect an extended low-level flight.
Flight — Attitude and controls		
Excessive pitch (height related — turnover (T/O), cruising or landing)	Pitch attitude, Rad Alt elevation, Lat & Long	To identify inappropriate use of excessive pitch attitude during flight. Height limits may be used (i.e. on take-off and landing or < 500 ft) — Lat & Long required for specific-location-related limits. Elevation less accurate than Rad Alt. Elevation can be used to identify the landing phase in a specific location.
Excessive pitch (speed related — T/O, cruising or landing)	Pitch attitude, IAS, GS, Lat & Long	To identify inappropriate use of excessive pitch attitude during flight. Speed limits may be used (i.e. on take-off and landing or in cruising) — Lat & Long required for specific-location-related limits. GS less accurate than IAS.
Excessive pitch rate	Pitch rate, Rad Alt, IAS, ground switch (similar), Lat & Long	To identify inappropriate use of excessive rate of pitch change

APPLICABLE FROM 1 JULY 2018

		during flight. Height limits may be used (i.e. on take-off and landing). IAS only for IAS limit, ground switch (similar) and Lat & Long required for specific-location-related limits.
Excessive roll/bank attitude (speed or height related)	Roll attitude, Rad Alt, IAS/GS	To identify excessive use of roll attitude. Rad Alt may be used for height limits, IAS/GS may be used for speed limits.
Excessive roll rate	Roll rate, Rad Alt, Lat & Long, Ground switch (similar)	Rad Alt may be used for height limits, Lat & Long and ground switch (similar) required for specific-location-related and air/ground limits.
Excessive yaw rate	Yaw rate	To detect excessive yaw rates in flight.
Excessive lateral cyclic control	Lateral cyclic position, ground switch (similar)	To detect movement of the lateral cyclic control to extreme left or right positions. Ground switch (similar) required for pre or post T/O.
Excessive longitudinal cyclic control	Longitudinal cyclic position, ground switch (similar)	To detect movement of the longitudinal cyclic control to extreme forward or aft positions. Ground switch (similar) required for pre or post T/O.
Excessive collective pitch control	Collective position, ground switch (similar)	To detect exceedances of the aircraft flight manual (AFM) collective pitch limit. Ground switch (similar) required for pre or post T/O.
Excessive tail rotor control	Pedal position, ground switch (similar)	To detect movement of the tail rotor pedals to extreme left and right positions. Ground switch (similar) required for pre or post T/O.
Manoeuvre G loading or turbulence	Lat & Long, normal accelerations, ground switch (similar) or Rad Alt	To identify excessive G loading of the rotor disc, both positive and negative. Ground switch (similar) required to determine air/ground. Rad Alt required if height limit

APPLICABLE FROM 1 JULY 2018

		required.
Pilot workload/turbulence	Collective and/or cyclic and/or tail rotor pedal position and change rate (Lat & Long)	To detect high workload and/or turbulence encountered during take-off and landing phases. Lat & Long required for specific landing sites. A specific and complicated algorithm for this event is required. See United Kingdom Civil Aviation Authority (UK CAA) Paper 2002/02.
Cross controlling	Roll rate, yaw rate, pitch rate, GS, accelerations	To detect an 'out of balance' flight. Airspeed could be used instead of GS.
Quick stop	GS (min and max), V/S, pitch	To identify inappropriate flight characteristics. Airspeed could be used instead of GS.
Flight — General		
OEI — Air	OEI discreet, ground switch (similar)	To detect OEI conditions in flight.
Single engine flight	No 1 engine Tq, No 2 engine Tq	To detect single-engine flight.
Torque split	No 1 engine Tq, No 2 engine Tq	To identify engine-related issues.
Pilot event	Pilot event discreet	To identify when flight crews have depressed the pilot event button.
Traffic collision avoidance system (TCAS) traffic advisory (TA)	TCAS TA discreet	To identify TCAS alerts.
Training computer active	Training computer mode active or discreet	To identify when helicopter have been on training flights.
High/low rotor speed — power on	NR, Tq (ground switch (similar), IAS, GS)	To identify mishandling of NR. Ground switch (similar), IAS or ground speed required to determine whether helicopter is airborne.
High/low rotor speed — power off	NR, Tq (ground switch (similar), IAS, GS)	To identify mishandling of NR. Ground switch (similar), IAS or ground speed to determine whether helicopter is airborne.
Fuel content low	Fuel contents	To identify low-fuel alerts.
Helicopter terrain awareness and warning system (HTAWS) alert	HTAWS alerts discreet	To identify when HTAWS alerts have been activated.

APPLICABLE FROM 1 JULY 2018

Automatic voice alert device (AVAD) alert	AVAD discreet	To identify when AVAD alerts have been activated.
Bleed air system use during take-off (e.g. heating)	Bleed air system discreet, ground switch (similar), IAS	To identify use of engine bleed air during periods of high power demand.
Rotors' running duration	NR, elapsed time	To identify rotors' running time for billing purposes.
Flight — Approach		
Stable approach heading change	Magnetic heading, Rad Alt, ground switch (similar), gear position, elapsed time	To identify unstable approaches.
Stable approach pitch attitude	Pitch attitude, Rad Alt, ground switch (similar), gear position	To identify unstable approaches.
Stable approach rod GS	Altitude rate, Rad Alt, ground switch (similar), gear position	To identify unstable approaches.
Stable approach track change	Track, Rad Alt, ground switch (similar), gear position	To identify unstable approaches.
Stable approach angle of bank	Roll attitude, Rad Alt, ground switch (similar), gear position	To identify unstable approaches.
Stable approach — rod at specified height	Altitude rate, Rad Alt, ground switch (similar), gear position	To identify unstable approaches.
Stable approach — IAS at specified height	IAS, Rad Alt, ground switch (similar), gear position	To identify unstable approaches.
Glideslope deviation above or below	Glideslope deviation	To identify inaccurately flown instrument landing system (ILS) approaches.
Localiser deviation left and right	Localiser deviation	To identify inaccurately flown ILS approaches.
Low turn to final	Elevation, GS, V/S, heading change	Airspeed could be used instead of GS.
Premature turn to final	Elevation, GS, V/S, heading change	Airspeed could be used instead of GS.
Stable approach — climb	IAS (min & max), V/S (min & max), elevation	To identify unstable approaches.
Stable approach — descent	IAS (min & max), V/S, elevation	To identify unstable approaches.
Stable approach — bank	IAS (min & max), V/S, elevation, roll	To identify unstable approaches.
Stable approach — late turn	Heading change, elevation, GS	To identify unstable approaches.

APPLICABLE FROM 1 JULY 2018

Go-around	Gear select (Rad Alt)	To identify missed approaches. Rad Alt for height limit.
Rate of descent on approach	Altitude rate, Rad Alt, Lat & Long, ground switch (similar)	To identify high rates of descent when at low level on approach. Rad Alt if below specified height, Lat & Long for specified location required.
Flight — Autopilot		
Condition of autopilot in flight	Autopilot discreet	To detect flight without autopilot engaged; per channel for multichannel autopilots.
Autopilot engaged within 10 sec after take-off	Autopilot engaged discreet, elapsed time, ground switch (similar), total Tq, Rad Alt	To identify inadvertent lift-off without autopilot engaged.
Autopilot engaged on ground (postflight or preflight)	Autopilot engaged discreet, elapsed time, ground switch (similar), total Tq, Rad Alt	To identify inappropriate use of autopilot when on ground. Elapsed time required to allow for permissible short periods.
Excessive pitch attitude with autopilot engaged on ground (offshore)	Pitch attitude, autopilot discreet, ground switch (similar), Lat & Long	To identify potential for low NR when helicopter pitches on floating helideck.
Airspeed hold engaged — airspeed (departure or non-departure)	Autopilot modes discreet, IAS, (ground switch (similar), total Tq, Rad Alt)	To detect early engagement of autopilot higher modes. Ground switch (similar), total Tq and Rad Alt to determine if the flight profile is 'departure'.
Airspeed hold engaged — altitude (departure or non-departure)	Autopilot modes discreet, Rad Alt, (IAS, ground switch (similar), total Tq)	To detect early engagement of autopilot higher modes. IAS, ground switch (similar), total Tq to determine if the flight profile is 'departure'.
Alt mode engaged — altitude (departure or non-departure)	Autopilot modes discreet, Rad Alt, (ground switch (similar), total Tq, IAS)	To detect early engagement of autopilot higher modes. Ground switch (similar), total Tq and Rad Alt to determine if the flight profile is 'departure'.
Alt mode engaged — airspeed (departure or non-departure)	Autopilot modes discreet, IAS, (ground switch (similar), total Tq, Rad Alt)	To detect early engagement of autopilot higher modes. IAS, ground switch (similar), total Tq to determine if the flight profile is

APPLICABLE FROM 1 JULY 2018

		'departure'.
Heading mode engaged — speed	Autopilot modes discreet, IAS	To detect engagement of autopilot higher modes below minimum speed limitations. Ground switch (similar), total Tq and Rad Alt to determine if the flight profile is 'departure'.
V/S mode active — below specified speed	Autopilot modes discreet, IAS	To detect engagement of autopilot higher modes below minimum speed limitations.
VS mode engaged — altitude (departure or non-departure)	Autopilot modes discreet, IAS, (WOW, total Tq, Rad Alt)	To detect early engagement of autopilot higher modes. Ground switch (similar), total Tq and Rad Alt to determine if the flight profile is 'departure'.
Flight director (FD) engaged — speed	FD discreet, IAS	To detect engagement of autopilot higher modes below minimum speed limitations.
FD-coupled approach or take off — airspeed	FD discreet, IAS, ground switch (similar)	To detect engagement of autopilot higher modes below minimum speed limitations.
Go-around mode engaged — airspeed	Autopilot modes discreet, IAS, ground switch (similar), total Tq, Rad Alt	To detect engagement of autopilot higher modes below minimum speed limitations.
Flight without autopilot channels engaged	Autopilot channels	To detect flight without autopilot engaged; per channel for multichannel autopilots.

SPA.HOFO.150 Aircraft tracking system

An operator shall establish and maintain a monitored aircraft tracking system for offshore operations in a hostile environment from the time the helicopter departs until it arrives at its final destination.

AMC1 SPA.HOFO.150 Aircraft tracking system

GENERAL

Flights should be tracked and monitored from take-off to landing. This function may be achieved by the air traffic services (ATS) when the planned route and the planned diversion routes are fully included in airspace blocks where:

- (a) ATS surveillance service is normally provided and supported by ATC surveillance systems locating the aircraft at time intervals with adequate duration; and
- (b) the operator has given to competent air navigation services (ANS) providers the necessary contact information.

In all other cases, the operator should establish a detailed procedure describing how the aircraft tracking system is to be monitored, and what actions and when are to be taken if a deviation or anomaly has been detected.

GM1 SPA.HOFO.150 Aircraft tracking system

OPERATIONAL PROCEDURE

The procedure should take into account the following aspects:

- (a) the outcome of the risk assessment made when the update frequency of the information was defined;
- (b) the local environment of the intended operations; and
- (c) the relationship with the operator's emergency response plan.

Aircraft tracking data should be recorded on the ground and retained for at least 48 h. Following an accident or a serious incident subject to investigation, the data should be retained for at least 30 days, and the operator should be capable of providing a copy of this data without delay.

SPA.HOFO.155 Vibration health monitoring (VHM) system

- (a) The following helicopters conducting CAT offshore operations in a hostile environment shall be fitted with a VHM system capable of monitoring the status of critical rotor and rotor drive systems by 1 January 2019:
- (1) complex motor-powered helicopters first issued with an individual Certificate of Airworthiness (CofA) after 31 December 2016;
 - (2) all helicopters with a maximum operational passenger seating configuration (MOPSC) of more than 9 and first issued with an individual CofA before 1 January 2017;
 - (3) all helicopters first issued with an individual CofA after 31 December 2018.
- (b) The operator shall have a system to:
- (1) collect the data including system generated alerts;
 - (2) analyse and determine component serviceability; and
 - (3) respond to detected incipient failures.

AMC1 SPA.HOFO.155 Vibration health monitoring (VHM) system

GENERAL

Any VHM system should meet all of the following criteria:

(a) VHM system capability

The VHM system should measure vibration characteristics of rotating critical components during flight, using suitable vibration sensors, techniques, and recording equipment. The frequency and flight phases of data measurement should be established together with the type certificate holder (TCH) during the initial entry into service. In order to appropriately manage the generated data and focus upon significant issues, an alerting system should be established; this is normally automatic. Accordingly, alert generation processes should be developed to reliably advise maintenance personnel of the need to intervene and help determine what type of intervention is required.

(b) Approval of VHM installation

The VHM system, which typically comprises vibration sensors and associated wiring, data acquisition and processing hardware, the means of downloading data from the helicopter, the ground-based system and all associated instructions for operation of the system, should be certified in accordance with CS-29 or equivalent, established by the Agency.

Note: for applications that may also provide maintenance credit (see Federal Aviation Administration (FAA) Advisory Circular (AC) 29-2C Miscellaneous Guidance (MG) 15), the level of system integrity required may be higher.

(c) Operational procedures

The operator should establish procedures to address all necessary VHM subjects.

(d) Training

The operator should determine which staff will require VHM training, determine appropriate syllabi, and incorporate them into the operator's initial and recurrent training programmes.

GM1 SPA.HOFO.155 Vibration health monitoring (VHM) system

GENERAL

Operators should utilise available international guidance material provided for the specification and design of VHM systems.

Further guidance can be found in:

- (a) CS 29.1465 Vibration health monitoring and associated AMC;
- (b) Federal Aviation Administration (FAA) Advisory Circular (AC) 29-2C Miscellaneous Guidance (MG) 15 — Airworthiness Approval of Rotorcraft Health Usage Monitoring Systems (HUMSs); and
- (c) United Kingdom Civil Aviation Authority (UK CAA) CAP 753 — Helicopter Vibration Health Monitoring.

SPA.HOFO.160 Equipment requirements

- (a) The operator shall comply with the following equipment requirements:
- (1) Public Address (PA) system in helicopters used for CAT and non-commercial operations with complex motor-powered helicopters (NCC):
- (i) Helicopters with a maximum operational passenger seat configuration (MOPSC) of more than 9 shall be equipped with a PA system.
- (ii) Helicopters with an MOPSC of 9 or less need not be equipped with a PA system if the operator can demonstrate that the pilot's voice is understandable at all passengers' seats in flight.
- (2) *Radio altimeter*
- Helicopters shall be equipped with a radio altimeter that is capable of emitting an audio warning below a pre-set height and a visual warning at a height selectable by the pilot.
- (b) *Emergency exits*
- All emergency exits, including crew emergency exits, and any door, window or other opening that is suitable for emergency egress, and the means for opening them shall be clearly marked for the guidance of occupants using them in daylight or in the dark. Such markings shall be designed to remain visible if the helicopter is capsized or the cabin is submerged.
- (c) *Helicopter terrain awareness warning system (HTAWS)*
- Helicopters used in CAT operations with a maximum certificated take-off mass of more than 3 175 kg or a MOPSC of more than 9 and first issued with an individual CofA after 31 December 2018 shall be equipped with an HTAWS that meets the requirements for class A equipment as specified in an acceptable standard.

GM1 SPA.HOFO.160(a)(1) Additional equipment requirements**PUBLIC ADDRESS (PA) SYSTEM**

When demonstrating the performance of the PA system or that the pilot's voice is understandable at all passengers' seats during flight, the operator should ensure compatibility with the passengers' use of ear defenders/ear plugs (hearing protection). The operator should only provide hearing protection that is compatible with the intelligibility of the PA system or pilot's voice, as appropriate.

GM1 SPA.HOFO.160(a)(2) Additional equipment requirements**RADIO ALTIMETER**

For additional information, please refer to AMC1 CAT.IDE.H.145 Radio altimeters and AMC2 CAT.IDE.H.145 Radio altimeters, as well as to GM1 CAT.IDE.H.145 Radio altimeters.

SPA.HOFO.165 Additional procedures and equipment for operations in a hostile environment**(a) Life jackets**

Approved life jackets shall be worn at all times by all persons on board unless integrated survival suits that meet the combined requirement of the survival suit and life jacket are worn.

(b) Survival suits

All passengers on board shall wear an approved survival suit:

- (1) when the weather report or forecasts available to the commander/pilot-in-command indicate that the sea temperature will be less than plus 10 °C during the flight; or
- (2) when the estimated rescue time exceeds the calculated survival time; or
- (3) when the flight is planned to be conducted at night.

(c) Emergency breathing system

All persons on board shall carry and be instructed in the use of emergency breathing systems.

(d) Life rafts

- (1) All life rafts carried shall be installed so as to be usable in the sea conditions in which the helicopter's ditching, flotation, and trim characteristics were evaluated for certification.
- (2) All life rafts carried shall be installed so as to facilitate their ready use in an emergency.
- (3) The number of life rafts installed:
 - (i) in the case of a helicopter carrying less than 12 persons, at least one life raft with a rated capacity of not less than the maximum number of persons on board; or
 - (ii) in the case of a helicopter carrying more than 11 persons, at least two life rafts, sufficient together to accommodate all persons capable of being carried on board and, if one is lost, the remaining life raft(s) having the overload capacity sufficient to accommodate all persons on the helicopter.
- (4) Each life raft shall contain at least one survival emergency locator transmitter (ELT(S)); and
- (5) Each life raft shall contain life-saving equipment, including means of sustaining life, as appropriate to the flight to be undertaken.

(e) Emergency cabin lighting

The helicopter shall be equipped with an emergency lighting system with an independent power supply to provide a source of general cabin illumination to facilitate the evacuation of the helicopter.

(f) Automatically deployable emergency locator transmitter (ELT(AD))

The helicopter shall be equipped with an ELT(AD) that is capable of transmitting simultaneously on 121,5 MHz and 406 MHz.

(g) Securing of non-jettisonable doors

Non-jettisonable doors that are designated as ditching emergency exits shall have a means of securing them in the open position so that they do not interfere with the occupants' egress in all sea conditions up to the maximum sea conditions required to be evaluated for ditching and flotation.

(h) Emergency exits and escape hatches

All emergency exits, including crew emergency exits, and any door, window or other opening suitable to be used for the purpose of underwater escape shall be equipped so as to be operable in an emergency.

- (i) Notwithstanding (a), (b) and (c) above the operator may, based on a risk assessment, allow passengers, medically incapacitated at an offshore location, to partly wear or not wear life jackets, survival suits or emergency breathing systems on return flights or flights between offshore locations.

AMC1 SPA.HOFO.165(c) Additional procedures and equipment for operations in hostile environment

EMERGENCY BREATHING SYSTEM (EBS)

The EBS of SPA.HOFO.165(c) should be an EBS system capable of rapid underwater deployment.

AMC1 SPA.HOFO.165(d) Additional procedures and equipment for operations in hostile environment

INSTALLATION OF THE LIFE RAFT

- (a) Projections on the exterior surface of the helicopter that are located in a zone delineated by boundaries that are 1.22 m (4 ft) above and 0.61 m (2 ft) below the established static waterline could cause damage to a deployed life raft. Examples of projections that need to be considered are aerials, overboard vents, unprotected split-pin tails, guttering, and any projection sharper than a three-dimensional right-angled corner.
- (b) While the boundaries specified in (a) above are intended as a guide, the total area that should be considered should also take into account the likely behaviour of the life raft after deployment in all sea states up to the maximum in which the helicopter is capable of remaining upright.
- (c) Wherever a modification or alteration is made to a helicopter within the boundaries specified, the need to prevent the modification or alteration from causing damage to a deployed life raft should be taken into account in the design.
- (d) Particular care should also be taken during routine maintenance to ensure that additional hazards are not introduced by, for example, leaving inspection panels with sharp corners proud of the surrounding fuselage surface, or by allowing door sills to deteriorate to a point where their sharp edges may become a hazard.

AMC1 SPA.HOFO.165(h) Additional procedures and equipment for operations in a hostile environment

EMERGENCY EXITS AND ESCAPE HATCHES

In order for all passengers to escape from the helicopter within an expected underwater survival time of 60 sec in the event of capsizing, the following provisions should be made:

- (a) there should be an easily accessible emergency exit or suitable opening for each passenger;
- (b) an opening in the passenger compartment should be considered suitable as an underwater escape facility if the following criteria are met:
 - (1) the means of opening should be rapid and obvious;
 - (2) passenger safety briefing material should include instructions on the use of such escape facilities;

- (3) for the egress of passengers with shoulder width of 559 mm (22 in.) or smaller, a rectangular opening should be no smaller than 356 mm (14 in.) wide, with a diagonal between corner radii no smaller than 559 mm (22 in.), when operated in accordance with the instructions;
 - (4) non-rectangular or partially obstructed openings (e.g. by a seat back) should be capable of admitting an ellipse of 559 mm x 356 mm (22 in. x 14 in.); and
 - (5) for the egress of passengers with shoulder width greater than 559 mm (22 in.), openings should be no smaller than 480 mm x 660 mm (19 in. x 26 in.) or be capable of admitting an ellipse of 480 mm x 660 mm (19 in. x 26 in.);
- (c) suitable openings and emergency exits should be used for the underwater escape of no more than two passengers, unless large enough to permit the simultaneous egress of two passengers side by side:
- (1) if the exit size provides an unobstructed area that encompasses two ellipses of size 480 mm x 660 mm (19 in. x 26 in.) side by side, then it may be used for four passengers; and
 - (2) if the exit size provides an unobstructed area that encompasses two ellipses of size 356 mm x 559 mm (14 in. x 22 in.) side by side, then it may be used for four passengers with shoulder width no greater than 559 mm (22 in.) each; and
- (d) passengers with shoulder width greater than 559 mm (22 in.) should be identified and allocated to seats with easy access to an emergency exit or opening that is suitable for them.

GM1 SPA.HOFO.165(h) Additional procedures and equipment for operations in a hostile environment

SEAT ALLOCATION

The identification and seating of the larger passengers might be achieved through the use of patterned and/or colour-coded armbands and matching seat headrests.

AMC1 SPA.HOFO.165(i) Additional procedures and equipment for operations in a hostile environment

MEDICALLY INCAPACITATED PASSENGER

- (a) A 'Medically incapacitated passenger' means a person who is unable to wear the required survival equipment, including life jackets, survival suits and emergency breathing systems (EBSs), as determined by a medical professional. The medical professional's determination should be made available to the pilot-in-command/commander prior to arrival at the offshore installation.
- (b) The operator should establish procedures for the cases where the pilot-in-command/commander may accept a medically incapacitated passenger not wearing or partially wearing survival equipment. To ensure proportionate mitigation of the risks associated with an evacuation, the procedures should be based on, but not be limited to, the severity of the incapacitation, sea and air temperature, sea state, and number of passengers on board.

In addition, the operator should establish the following procedures:

- (1) under which circumstances one or more dedicated persons are required to assist a medically incapacitated passenger during a possible emergency evacuation, and the skills and qualifications required;
- (2) seat allocation for the medically incapacitated passenger and possible assistants in the helicopter types used to ensure optimum use of the emergency exits; and

- (3) evacuation procedures related to whether or not the dedicated persons as described in (1) above are present.

SPA.HOFO.170 Crew requirements

- (a) The operator shall establish:
- (1) criteria for the selection of flight crew members, taking into account the flight crew members' previous experience;
 - (2) a minimum experience level for a commander/pilot-in-command intending to conduct offshore operations; and
 - (3) a flight crew training and checking programme that each flight crew member shall complete successfully. Such programme shall be adapted to the offshore environment and include normal, abnormal and emergency procedures, crew resource management, water entry and sea survival training.

(b) *Recency requirements*

A pilot shall only operate a helicopter carrying passengers:

- (1) at an offshore location, as commander or pilot-in-command, or co-pilot, when he or she has carried out in the preceding 90 days at least 3 take-offs, departures, approaches and landings at an offshore location in a helicopter of the same type or a full flight simulator (FFS) representing that type; or
- (2) by night at an offshore location, as commander or pilot-in-command, or co-pilot, when he/she has carried out in the preceding 90 days at least 3 take-offs, departures, approaches and landings at night at an offshore location in a helicopter of the same type or an FFS representing that type.

The 3 take-offs and landings shall be performed in either multi-pilot or single-pilot operations, depending on the operation to be performed.

(c) Specific requirements for CAT:

- (1) The 90-day period presented in points (b)(1) and (2) above may be extended to 120 days as long as the pilot undertakes line flying under the supervision of a type rating instructor or examiner.
- (2) If the pilot does not comply with the requirements in (1), he/she shall complete a training flight in the helicopter or an FFS of the helicopter type to be used, which shall include at least the requirements described in (b)(1) and (2) before he or she can exercise his or her privileges.

AMC1 SPA.HOFO.170(a) Crew requirements**FLIGHT CREW TRAINING AND CHECKING**

- (a) Flight crew training programmes should:
- (1) improve knowledge of the offshore operations environment with particular consideration of visual illusions during approach, introduced by lighting, motion and weather factors;
 - (2) improve crew cooperation specifically for offshore operations;
 - (3) provide flight crew members with the necessary skills to appropriately manage the risks associated with normal, abnormal and emergency procedures during flights by day and night;

- (4) if night operations are conducted, give particular consideration to approach, go-around, landing, and take-off phases;
 - (5) include instructions on the optimum use of the helicopter's automatic flight control system (AFCS);
 - (6) for multi-pilot operation, emphasise the importance of multi-crew procedures, as well as the role of the pilot monitoring during all phases of the flight; and
 - (7) include standard operating procedures.
- (b) Emergency and safety equipment training should focus on the equipment fitted/carried. Water entry and sea survival training, including operation of all associated safety equipment, should be an element of the recurrent training, as described in AMC1 ORO.FC.230(a)(2)(iii)(F).
- (c) The training elements referred to above should be assessed during: operator proficiency checks, line checks, or, as applicable, emergency and safety equipment checks.
- (d) Training and checking should make full use of full flight simulators (FFSs) for normal, abnormal, and emergency procedures related to all aspects of helicopter offshore operations (HOFO).

ANNEX VI

Non-Commercial Air Operations with Complex Motor-Powered Aircraft [PART-NCC]

SUBPART A: GENERAL REQUIREMENTS

NCC.GEN.100 Competent authority

The competent authority shall be the authority designated by the Member State in which the operator has its principal place of business or is residing.

NCC.GEN.105 Crew responsibilities

- (a) The crew member shall be responsible for the proper execution of his/her duties that are:
 - (1) related to the safety of the aircraft and its occupants; and
 - (2) specified in the instructions and procedures in the operations manual.
- (b) During critical phases of flight or whenever deemed necessary by the pilot-in-command in the interest of safety, the crew member shall be seated at his/her assigned station and shall not perform any activities other than those required for the safe operation of the aircraft.
- (c) During flight, the flight crew member shall keep his/her safety belt fastened while at his/her station.
- (d) During flight, at least one qualified flight crew member shall remain at the controls of the aircraft at all times.
- (e) The crew member shall not undertake duties on an aircraft:
 - (1) if he/she knows or suspects that he/she is suffering from fatigue as referred to in 7.f of Annex IV to Regulation (EC) No 216/2008 or feels otherwise unfit, to the extent that the flight may be endangered; or
 - (2) when under the influence of psychoactive substances or alcohol or for other reasons as referred to in 7.g of Annex IV to Regulation (EC) No 216/2008.
- (f) The crew member who undertakes duties for more than one operator shall:
 - (1) maintain his/her individual records regarding flight and duty times and rest periods as referred to in Annex III (Part-ORO), Subpart FTL to Regulation (EU) No 965/2012; and
 - (2) provide each operator with the data needed to schedule activities in accordance with the applicable FTL requirements.
- (g) The crew member shall report to the pilot-in-command:
 - (1) any fault, failure, malfunction or defect, which he/she believes may affect the airworthiness or safe operation of the aircraft, including emergency systems; and

- (2) any incident that was endangering, or could endanger, the safety of the operation.

GM1 NCC.GEN.105(e)(2) Crew responsibilities

GENERAL

In accordance with 7.g. of Annex IV to Regulation (EC) No 216/2008¹ (essential requirements for air operations), a crew member must not perform duties on board an aircraft when under the influence of psychoactive substances or alcohol or when unfit due to injury, fatigue, medication, sickness or other similar causes. This should be understood as including the following:

- (a) effects of deep water diving and blood donation, and allowing for a certain time period between these activities and returning to flying; and
- (b) without prejudice to more restrictive national regulations, the consumption of alcohol while on duty or less than 8 hours prior to the commencement of duties, and commencing a flight duty period with a blood alcohol level in excess of 0.2 per thousand.

AMC1 NCC.GEN.105(g) Crew responsibilities

OCCURRENCE REPORTING

Whenever a crew member makes use of the applicable reporting systems, a copy of the report should be communicated to the pilot-in-command.

¹ Regulation (EC) No 216/2008 of the European Parliament and of the Council of 20 February 2008 on common rules in the field of civil aviation and establishing a European Aviation Safety Agency, and repealing Council Directive 91/670/EEC, Regulation (EC) No 1592/2002 and Directive 2004/36/EC (OJ L 79, 19.3.2008, p. 1). Regulation as last amended by Regulation (EC) No 1108/2009 of the European Parliament and of the Council of 21 October 2009 (OJ L 309, 24.11.2009, p. 51).

NCC.GEN.106 Pilot-in-command responsibilities and authority

- (a) The pilot-in-command shall be responsible for:
- (1) the safety of the aircraft and of all crew members, passengers and cargo on board during aircraft operations as referred to in 1.c of Annex IV to Regulation (EC) No 216/2008;
 - (2) the initiation, continuation, termination or diversion of a flight in the interest of safety;
 - (3) ensuring that all instructions, operational procedures and checklists are complied with in accordance with the operations manual and as referred to in 1.b of Annex IV to Regulation (EC) No 216/2008;
 - (4) only commencing a flight if he/she is satisfied that all operational limitations referred to in 2.a.3 of Annex IV to Regulation (EC) No 216/2008 are complied with, as follows:
 - (i) the aircraft is airworthy;
 - (ii) the aircraft is duly registered;
 - (iii) instruments and equipment required for the execution of that flight are installed in the aircraft and are operative, unless operation with inoperative equipment is permitted by the minimum equipment list (MEL) or equivalent document, as required in NCC.IDE.A.105 or NCC.IDE.H.105;
 - (iv) the mass of the aircraft and centre of gravity location are such that the flight can be conducted within the limits prescribed in the airworthiness documentation;
 - (v) all cabin baggage, hold luggage and cargo are properly loaded and secured;
 - (vi) the aircraft operating limitations as specified in the aircraft flight manual (AFM) will not be exceeded at any time during the flight;
 - (vii) each flight crew member holds a valid licence in accordance with Regulation (EU) No 1178/2011;
 - (viii) flight crew members are properly rated and meet competency and recency requirements; and
 - (ix) any navigational database required for performance-based navigation is suitable and current;
 - (5) not commencing a flight if any flight crew member is incapacitated from performing duties by any cause such as injury, sickness, fatigue or the effects of any psychoactive substance;
 - (6) not continuing a flight beyond the nearest weather-permissible aerodrome or operating site, when the capacity of any flight crew member to perform duties is significantly reduced from causes such as fatigue, sickness or lack of oxygen;
 - (7) deciding on acceptance of the aircraft with unserviceabilities in accordance with the configuration deviation list (CDL) or minimum equipment list (MEL), as applicable;
 - (8) recording utilisation data and all known or suspected defects in the aircraft at the termination of the flight, or series of flights, in the aircraft technical log or journey log for the aircraft; and
 - (9) ensuring that:
 - (i) flight recorders are not disabled or switched off during flight;
 - (ii) in the event of an occurrence other than an accident or a serious incident that shall be reported according to ORO.GEN.160(a), flight recorders' recordings are not intentionally erased; and

- (iii) in the event of an accident or a serious incident, or if preservation of recordings of flight recorders is directed by the investigating authority:
 - (A) flight recorders' recordings are not intentionally erased;
 - (B) flight recorders are deactivated immediately after the flight is completed; and
 - (C) precautionary measures to preserve the recordings of flight recorders are taken before leaving the flight crew compartment.
- (b) The pilot-in-command shall have the authority to refuse carriage of or disembark any person, baggage or cargo that may represent a potential hazard to the safety of the aircraft or its occupants.
- (c) The pilot-in-command shall, as soon as possible, report to the appropriate air traffic services (ATS) unit any hazardous weather or flight conditions encountered that are likely to affect the safety of other aircraft.
- (d) Notwithstanding the provision of (a)(6), in a multi-crew operation the pilot-in-command may continue a flight beyond the nearest weather-permissible aerodrome when adequate mitigating procedures are in place.
- (e) The pilot-in-command shall, in an emergency situation that requires immediate decision and action, take any action he/she considers necessary under the circumstances in accordance with 7.d of Annex IV to Regulation (EC) No 216/2008. In such cases he/she may deviate from rules, operational procedures and methods in the interest of safety.
- (f) The pilot-in-command shall submit a report of an act of unlawful interference without delay to the competent authority and shall inform the designated local authority.
- (g) The pilot-in-command shall notify the nearest appropriate authority by the quickest available means of any accident involving the aircraft that results in serious injury or death of any person or substantial damage to the aircraft or property.

AMC1 NCC.GEN.106 Pilot-in-command responsibilities and authority

FLIGHT PREPARATION FOR PBN OPERATIONS

- (a) The flight crew should ensure that RNAV 1, RNAV 2, RNP 1 RNP 2, and RNP APCH routes or procedures to be used for the intended flight, including for any alternate aerodromes, are selectable from the navigation database and are not prohibited by NOTAM.
- (b) The flight crew should take account of any NOTAMs or operator briefing material that could adversely affect the aircraft system operation along its flight plan including any alternate aerodromes.
- (c) When PBN relies on GNSS systems for which RAIM is required for integrity, its availability should be verified during the preflight planning. In the event of a predicted continuous loss of fault detection of more than five minutes, the flight planning should be revised to reflect the lack of full PBN capability for that period.
- (d) For RNP 4 operations with only GNSS sensors, a fault detection and exclusion (FDE) check should be performed. The maximum allowable time for which FDE capability is projected to be unavailable on any one event is 25 minutes. If predictions indicate that the maximum allowable FDE outage will be exceeded, the operation should be rescheduled to a time when FDE is available.
- (e) For RNAV 10 operations, the flight crew should take account of the RNAV 10 time limit declared for the inertial system, if applicable, considering also the effect of weather conditions that could

affect flight duration in RNAV 10 airspace. Where an extension to the time limit is permitted, the flight crew will need to ensure that en route radio facilities are serviceable before departure, and to apply radio updates in accordance with any AFM limitation.

AMC2 NCC.GEN.106 Pilot-in-command responsibilities and authority

DATABASE SUITABILITY

- (a) The flight crew should check that any navigational database required for PBN operations includes the routes and procedures required for the flight.

DATABASE CURRENCY

- (b) The database validity (current AIRAC cycle) should be checked before the flight.
- (c) Navigation databases should be current for the duration of the flight. If the AIRAC cycle is due to change during flight, the flight crew should follow procedures established by the operator to ensure the accuracy of navigation data, including the suitability of navigation facilities used to define the routes and procedures for the flight.
- (d) An expired database may only be used if the following conditions are satisfied:
 - (1) the operator has confirmed that the parts of the database which are intended to be used during the flight and any contingencies that are reasonable to expect are not changed in the current version;
 - (2) any NOTAMs associated with the navigational data are taken into account;
 - (3) maps and charts corresponding to those parts of the flight are current and have not been amended since the last cycle;
 - (4) any MEL limitations are observed; and
 - (5) the database has expired by no more than 28 days.

GM1 NCC.GEN.106 Pilot-in-command responsibilities and authority

GENERAL

In accordance with 1.c. of Annex IV to Regulation (EC) No 216/2008 (Essential Requirements for air operations), the pilot-in-command is responsible for the operation and safety of the aircraft and for the safety of all crew members, passengers and cargo on board. This would normally be from the time that he/she assumes responsibility for the aircraft and passengers prior to a flight until the passengers are deplaned and escorted out of the operational area of the aerodrome or operating site and he/she relinquishes responsibility for the aircraft at the end of a flight or series of flights. The pilot-in-command's responsibilities and authority should be understood as including at least the following:

- (a) the safety of all crew members, passengers and cargo on board, as soon as he/she arrives on board, until he/she leaves the aircraft at the end of the flight; and
- (b) the operation and safety of the aircraft:
 - (1) for aeroplanes, from the moment it is first ready to move for the purpose of taxiing prior to take-off, until the moment it comes to rest at the end of the flight and the engine(s) used as primary propulsion unit(s) is/are shut down; or
 - (2) for helicopters, from the moment the engine(s) are started until the helicopter comes to rest at the end of the flight with the engine(s) shut down and the rotor blades stopped.

GM1 NCC.GEN.106(a)(9) Pilot-in-command responsibilities and authority

IDENTIFICATION OF THE SEVERITY OF AN OCCURRENCE BY THE PILOT-IN-COMMAND

The definitions of an accident and a serious incident as well as examples thereof can be found in Regulation (EU) No 996/2010 of the European Parliament and of the Council.

GM1 NCC.GEN.106(b) Pilot-in-command responsibilities and authority

AUTHORITY TO REFUSE CARRIAGE OR DISEMBARK

This may include:

- (a) passengers who have special needs that cannot be provided on the aircraft; or
- (b) persons that appear to be under the influence of alcohol or drugs.

AMC1 NCC.GEN.106(c) Pilot-in-command responsibilities and authority

REPORTING OF HAZARDOUS FLIGHT CONDITIONS

- (a) These reports should include any detail which may be pertinent to the safety of other aircraft.
- (b) Such reports should be made whenever any of the following conditions are encountered or observed:
 - (1) severe turbulence;
 - (2) severe icing;
 - (3) severe mountain wave;
 - (4) thunderstorms, with or without hail, that are obscured, embedded, widespread or in squall lines;
 - (5) heavy dust storm or heavy sandstorm;
 - (6) volcanic ash cloud; and
 - (7) unusual and/or increasing volcanic activity or a volcanic eruption.
- (c) When other meteorological conditions not listed above, e.g. wind shear, are encountered that, in the opinion of the pilot-in-command, may affect the safety or the efficiency of other aircraft operations, the pilot-in-command should advise the appropriate air traffic services (ATS) unit as soon as practicable.

AMC1 NCC.GEN.106(d) Pilot-in-command responsibilities and authority

MITIGATING MEASURES — FATIGUE

The use of additional crew members and/or controlled rest during flight as described in GM1 NCC.GEN.106(d) may be considered as appropriate fatigue mitigating measures.

GM1 NCC.GEN.106(d) Pilot-in-command responsibilities and authority

MITIGATING MEASURES — FATIGUE — CONTROLLED REST IN THE FLIGHT CREW COMPARTMENT

- (a) This Guidance Material (GM) addresses controlled rest taken by the minimum certified flight crew. It is not related to planned in-flight rest by members of an augmented crew.

- (b) Although flight crew members should stay alert at all times during flight, unexpected fatigue can occur as a result of sleep disturbance and circadian disruption. To cater for this unexpected fatigue, and to regain a high level of alertness, a controlled rest procedure in the flight crew compartment, organised by the pilot-in-command, may be used, if workload permits. 'Controlled rest' means a period of time 'off task' that may include actual sleep. The use of controlled rest has been shown to significantly increase the levels of alertness during the later phases of flight, particularly after the top of descent, and is considered to be good use of crew resource management (CRM) principles. Controlled rest should be used in conjunction with other on board fatigue management countermeasures such as physical exercise, bright flight crew compartment illumination at appropriate times, balanced eating and drinking and intellectual activity.
- (c) Controlled rest taken in this way should not be considered to be part of a rest period for the purposes of calculating flight time limitations, nor used to justify any duty period extension. Controlled rest may be used to manage both sudden unexpected fatigue and fatigue that is expected to become more severe during higher workload periods later in the flight. Controlled rest is not related to fatigue management, which is planned before flight.
- (d) Controlled rest periods should be agreed according to individual needs and the accepted principles of CRM; where the involvement of the cabin crew is required, consideration should be given to their workload.
- (e) When applying controlled rest procedures, the pilot-in-command should ensure that:
- (1) the other flight crew member(s) is(are) adequately briefed to carry out the duties of the resting flight crew member;
 - (2) one flight crew member is fully able to exercise control of the aircraft at all times; and
 - (3) any system intervention that would normally require a cross-check according to multi-crew principles is avoided until the resting flight crew member resumes his/her duties.
- (f) Controlled rest procedures should satisfy the following criteria:
- (1) only one flight crew member at a time should take rest at his/her station; the harness should be used and the seat positioned to minimise unintentional interference with the controls;
 - (2) the rest period should be no longer than 45 minutes (in order to limit any actual sleep to approximately 30 minutes) so as to limit deep sleep and associated long recovery time (sleep inertia);
 - (3) after this 45-minute period, there should be a recovery period of 20 minutes during which sole control of the aircraft should not be entrusted to the flight crew member taking controlled rest;
 - (4) in the case of two-crew operations, means should be established to ensure that the non-resting flight crew member remains alert. This may include:
 - (i) appropriate alarm systems;
 - (ii) on board systems to monitor flight crew activity; and
 - (iii) where cabin crew are on board the aircraft, frequent cabin crew checks. In this case, the pilot-in-command should inform the cabin crew member of the intention of the flight crew member to take controlled rest, and of the time of the end of that rest; frequent contact should be established between the non-resting flight crew member and the cabin crew by communication means, and the cabin crew should check that the resting flight crew member is alert at the end of the period;

- (5) there should be a minimum of 20 minutes between two sequential controlled rest periods in order to overcome the effects of sleep inertia and allow for adequate briefing;
- (6) if necessary, a flight crew member may take more than one rest period, if time permits, on longer sectors, subject to the restrictions above; and
- (7) controlled rest periods should terminate at least 30 minutes before the top of descent.

AMC1 NCC.GEN.106 (e) Pilot-in-command responsibilities and authority

VIOLATION REPORTING

If required by the State in which the incident occurs, the pilot-in-command should submit a report on any such violation to the appropriate authority of such State; in that event, the pilot-in-command should also submit a copy of it to the competent authority. Such reports should be submitted as soon as possible and normally within 10 days.

NCC.GEN.110 Compliance with laws, regulations and procedures

- (a) The pilot-in-command shall comply with the laws, regulations and procedures of those States where operations are conducted.
- (b) The pilot-in-command shall be familiar with the laws, regulations and procedures, pertinent to the performance of his/her duties, prescribed for the areas to be traversed, the aerodromes or operating sites to be used and the related air navigation facilities as referred to in 1.a of Annex IV to Regulation (EC) No 216/2008.

NCC.GEN.115 Common language

The operator shall ensure that all crew members can communicate with each other in a common language.

NCC.GEN.119 Taxiing of aircraft

The operator shall establish procedures for taxiing to ensure safe operation and to enhance runway safety.

AMC1 NCC.GEN.119 Taxiing of aircraft

PROCEDURES FOR TAXIING

Procedures for taxiing should include at least the following:

- (a) application of the sterile flight crew compartment procedures;
- (b) use of standard radio-telephony (RTF) phraseology;
- (c) use of lights;
- (d) measures to enhance the situational awareness of the minimum required flight crew members. The following list of typical items should be adapted by the operator to take into account its operational environment:
 - (1) each flight crew member should have the necessary aerodrome layout charts available;
 - (2) the pilot taxiing the aircraft should announce in advance his/her intentions to the pilot monitoring;
 - (3) all taxi clearances should be heard, and should be understood by each flight crew member;
 - (4) all taxi clearances should be cross-checked against the aerodrome chart and aerodrome surface markings, signs, and lights;
 - (5) an aircraft taxiing on the manoeuvring area should stop and hold at all lighted stop bars, and may proceed further when an explicit clearance to enter or cross the runway has been issued by the aerodrome control tower, and when the stop bar lights are switched off;
 - (6) if the pilot taxiing the aircraft is unsure of his/her position, he/she should stop the aircraft and contact air traffic control;
 - (7) the pilot monitoring should monitor the taxi progress and adherence to the clearances, and should assist the pilot taxiing;
 - (8) any action which may disturb the flight crew from the taxi activity should be avoided or done with the parking brake set (e.g. announcements by public address);
- (e) subparagraphs (d)(2) and (d)(7) are not applicable to single-pilot operations.

NCC.GEN.120 Taxiing of aeroplanes

The operator shall ensure that an aeroplane is only taxied on the movement area of an aerodrome if the person at the controls:

- (a) is an appropriately qualified pilot; or
- (b) has been designated by the operator and:
 - (1) is trained to taxi the aeroplane;
 - (2) is trained to use the radio telephone, if radio communications are required;
 - (3) has received instruction in respect of aerodrome layout, routes, signs, marking, lights, air traffic control (ATC) signals and instructions, phraseology and procedures; and
 - (4) is able to conform to the operational standards required for safe aeroplane movement at the aerodrome.

GM1 NCC.GEN.120 Taxiing of aeroplanes

SAFETY-CRITICAL ACTIVITY

- (a) Taxiing should be treated as a safety-critical activity due to the risks related to the movement of the aeroplane and the potential for a catastrophic event on the ground.
- (b) Taxiing is a high-workload phase of flight that requires the full attention of the flight crew.

GM1 NCC.GEN.120(b)(4) Taxiing of aeroplanes

SKILLS AND KNOWLEDGE

The person designated by the operator to taxi an aeroplane should possess the following skills and knowledge:

- (a) Positioning of the aeroplane to ensure safety when starting engine;
- (b) Getting ATIS reports and taxi clearance, where applicable;
- (c) Interpretation of airfield markings/lights/signals/indicators;
- (d) Interpretation of marshalling signals, where applicable;
- (e) Identification of suitable parking area;
- (f) Maintaining lookout and right-of-way rules and complying with ATC or marshalling instructions when applicable;
- (g) Avoidance of adverse effect of propeller slipstream or jet wash on other aeroplanes, aerodrome facilities and personnel;
- (h) Inspection of taxi path when surface conditions are obscured;
- (i) Communication with others when controlling an aeroplane on the ground;
- (j) Interpretation of operational instructions;
- (k) Reporting of any problem that may occur while taxiing an aeroplane; and
- (l) Adapting the taxi speed in accordance with prevailing aerodrome, traffic, surface and weather conditions.

NCC.GEN.125 Rotor engagement — helicopters

A helicopter rotor shall only be turned under power for the purpose of flight with a qualified pilot at the controls.

GM1 NCC.GEN.125 Rotor engagement

INTENT OF THE RULE

- (a) The following two situations where it is allowed to turn the rotor under power should be distinguished:
- (1) for the purpose of flight, as described in the Implementing Rule;
 - (2) for maintenance purposes.
- (b) Rotor engagement for the purpose of flight: it should be noted that the pilot should not leave the control when the rotors are turning. For example, the pilot is not allowed to get out of the aircraft in order to welcome passengers and adjust their seat belts with the rotors turning.
- (c) Rotor engagement for the purpose of maintenance: the Implementing Rule, however, should not prevent ground runs being conducted by qualified personnel other than pilots for maintenance purposes.

The following conditions should be applied:

- (1) The operator should ensure that the qualification of personnel, other than pilots, who are authorised to conduct maintenance runs, is described in the appropriate manual.
- (2) Ground runs should not include taxiing the helicopter.
- (3) There should be no passengers on board.
- (4) Maintenance runs should not include collective increase or autopilot engagement (risk of ground resonance).

NCC.GEN.130 Portable electronic devices

The operator shall not permit any person to use a portable electronic device (PED) on board an aircraft that could adversely affect the performance of the aircraft's systems and equipment.

AMC1 NCC.GEN.130 Portable electronic devices

TECHNICAL PREREQUISITES FOR THE USE OF PEDS

(a) Scope

This AMC describes the technical prerequisites under which any kind of portable electronic device (PED) may be used on board the aircraft without adversely affecting the performance of the aircraft's systems and equipment.

(b) Prerequisites concerning the aircraft configuration

- (1) Before an operator may permit the use of any kind of PED on-board, it should ensure that PEDs have no impact on the safe operation of the aircraft. The operator should demonstrate that PEDs do not interfere with on-board electronic systems and equipment, especially with the aircraft's navigation and communication systems.
- (2) The assessment of PED tolerance may be tailored to the different aircraft zones for which the use of PEDs is considered, i.e. may address separately:
 - (i) the passenger compartment;
 - (ii) the flight crew compartment; and
 - (iii) areas not accessible during the flight.

(c) Scenarios for permitting the use of PEDs

- (1) Possible scenarios, under which the operator may permit the use of PEDs, should be as documented in Table 1. The scenarios in Table 1 are listed in a descending order with the least permitting scenario at the bottom.
- (2) Restrictions arising from the corresponding aircraft certification, as documented in the aircraft flight manual (AFM) or equivalent document(s), should stay in force. They may be linked to different aircraft zones, or to particular transmitting technologies covered.
- (3) For Scenarios Nos. 3 to 8 in Table 1 the use of C-PEDs and cargo tracking devices may be further expanded, when the EMI assessment has demonstrated that there is no impact on safety as follows:
 - (i) for C-PEDs by using the method described in (d)(2); and
 - (ii) for cargo tracking devices by using the method described in (d)(3).

Table 1 – Scenarios for permitting the use of PEDs by the operator

No.	Technical condition	Non-intentional transmitters	T-PEDs
1	The aircraft is certified as T-PED tolerant, i.e. it has been demonstrated during the aircraft certification process that front door and back door coupling have no impact on the safe operation of the aircraft	All phases of flight	All phases of flight

No.	Technical condition	Non-intentional transmitters	T-PEDs
2	A complete electromagnetic interference (EMI) assessment for all technologies, using the method described in (d)(1), has been performed and has demonstrated the T-PED tolerance	All phases of flight	All phases of flight
3	The aircraft is certified for the use of T-PEDs using particular technologies (e.g. WLAN or mobile phone)	All phases of flight	All phases of flight, restricted to those particular technologies
4	The EMI assessment, using the method described in (d)(1), has demonstrated that: (a) the front door coupling has no impact on safety; and (b) the back door coupling has no impact on safety when using particular technologies (e.g. WLAN or mobile phone)	All phases of flight	All phases of flight, restricted to those particular technologies
5	The EMI assessment, using the method described in (d)(1)(i), has demonstrated that the front door coupling has no impact on safety caused by non-intentional transmitters	All phases of flight	Not permitted
6	The EMI assessment, using the method described in (d)(1)(ii), has demonstrated that the back door coupling has no impact on safety when using particular technologies (e.g. WLAN or mobile phone)	All phases of flight - except low visibility approach operation	All phases of flight - except low visibility approach operation, restricted to those particular technologies
7	An EMI assessment has not been performed	All phases of flight - except low visibility approach operation	Not permitted
8	Notwithstanding Scenarios Nos. 3 to 7	(a) before taxi-out; (b) during taxi-in after the end of landing roll; and (c) the pilot-in-command may permit the use during prolonged departure delays, provided that sufficient time is available to check the passenger compartment before the flight proceeds	

(d) Demonstration of electromagnetic compatibility

(1) EMI assessment at aircraft level

The means to demonstrate that the radio frequency (RF) emissions (intentional or non-intentional) are tolerated by aircraft systems should be as follows:

- (i) to address front door coupling susceptibility for any kind of PEDs:
 - (A) RTCA, 'Guidance on allowing transmitting portable, electronic devices (T-PEDs) on aircraft', DO-294C (or later revisions), Appendix 5C; or
 - (B) RTCA, 'Aircraft design and certification for portable electronic device (PED) tolerance', DO-307 (including Change 1 or later revisions), Section 4; and
 - (ii) to address back door coupling susceptibility for T-PEDs:
 - (A) EUROCAE, 'Guidance for the use of portable electronic devices (PEDs) on board aircraft', ED-130 (or later revisions), Annex 6;
 - (B) RTCA DO-294C (or later revisions), Appendix 6D; or
 - (C) RTCA DO-307 (including Change 1 or later revisions), Section 3.
- (2) Alternative EMI assessment of C-PEDs
- (i) For front door coupling:
 - (A) C-PEDs should comply with the levels as defined by:
 - (a) EUROCAE/RTCA, 'Environmental conditions and test procedures for airborne equipment', ED-14D/DO-160D (or later revisions), Section 21, Category M, for operation in the passenger compartment and the flight crew compartment; and
 - (b) EUROCAE ED-14E/RTCA DO-160E (or later revisions), Section 21, Category H, for operation in areas not accessible during the flight.
 - (B) If the C-PEDs are electronic flight bags used in the flight crew compartment, an alternative compliance method described in EASA, 'General acceptable means of compliance for airworthiness of products, part and appliances', AMC-20, AMC 20-25 ('Airworthiness and operational considerations for electronic flight bags'), may be used.
 - (ii) For back door coupling the EMI assessment described in (1)(ii) should be performed.
- (3) Alternative EMI assessment of cargo tracking devices

In case a transmitting function is automatically deactivated in a cargo tracking device (being a T-PED), the unit should be qualified for safe operation on board the aircraft. One of the following methods should be considered acceptable as evidence for safe operation:

- (i) A type-specific safety assessment, including failure mode and effects analysis, has been performed at aircraft level. The main purpose of the assessment should be to determine the worst hazards and to demonstrate an adequate design assurance level of the relevant hardware and software components of the cargo tracking device.
- (ii) The high intensity radiated field (HIRF) certification of the aircraft has been performed, i.e. the aircraft type has been certified after 1987 and meets the appropriate special condition. In such a case, the operator should observe the following:
 - (A) The tracking device:
 - (a) features an automated and prolonged radio suspension in flight using multiple modes of redundancy; and

- (b) has been verified in the aircraft environment to ensure deactivation of the transmitting function in flight.
 - (B) The transmissions of the tracking device are limited per design to short periods of time (less than 1 second per 1 000 seconds) and cannot be continuous.
 - (C) The tracking devices should comply with the levels as defined by EUROCAE ED-14E/RTCA DO-160E (or later revisions), Section 21, Category H.
 - (D) In order to provide assurance on the tracking device design and production, the following documents are retained as part of the evaluation package:
 - (a) operational description, technical specifications, product label and images of the tracking device and any peripheral attachments;
 - (b) failure mode and effects analysis report of the tracking device and any peripheral attachments;
 - (c) declaration of stringent design and production controls in place during the tracking device manufacturing;
 - (d) declaration of conformity and technical documentation showing compliance to the European Norms (EN), regulating the transmitter characteristic of the tracking device or its transmission module; and
 - (e) an EMI assessment report documenting the emission levels.
 - (iii) The tracking device interference levels during transmission are below those considered acceptable for the specific aircraft environment.
- (e) Operational conditions of C-PEDS and cargo tracking devices

The operator should ensure that C-PEDs and cargo tracking devices are maintained in good and safe condition, having in mind that:

 - (1) damage may modify their emissions characteristics; and
 - (2) damage to the battery may create a fire hazard.
- (f) Batteries in C-PEDs and cargo tracking devices

Lithium-type batteries in C-PEDs and cargo tracking devices should meet:

 - (1) United Nations (UN) Transportation Regulations, 'Recommendations on the transport of dangerous goods - manual of tests and criteria', UN ST/SG/AC.10/11; and
 - (2) one of the following standards:
 - (i) Underwriters Laboratory, 'Lithium batteries', UL 1642;
 - (ii) Underwriters Laboratory, 'Household and commercial batteries', UL 2054;
 - (iii) Underwriters Laboratory, 'Information technology equipment – safety', UL 60950-1;
 - (iv) International Electrotechnical Commission (IEC), 'Secondary cells and batteries containing alkaline or other non-acid electrolytes - safety requirements for portable sealed secondary cells, and for batteries made from them, for use in portable applications', IEC 62133;
 - (v) RTCA, 'Minimum operational performance standards for rechargeable lithium battery systems', DO-311. RTCA DO-311 may be used to address concerns regarding overcharging, over-discharging, and the flammability of cell components. The standard is intended to test permanently installed equipment; however, these tests

are applicable and sufficient to test electronic flight bags rechargeable lithium-type batteries; or

- (vi) European Technical Standard Order (ETSO), 'Non-rechargeable lithium cells and batteries', ETSO C142a.

AMC2 NCC.GEN.130 Portable electronic devices

PROCEDURES FOR THE USE OF PEDS

(a) Scope

This AMC describes the procedures under which any kind of portable electronic device (PED) may be used on board the aircraft without adversely affecting the performance of the aircraft's systems and equipment. This AMC addresses the operation of PEDs in the different aircraft zones — passenger compartment, flight compartment, and areas inaccessible during the flight.

(b) Prerequisites

Before permitting the use of any kind of PEDs the operator should ensure compliance with (c) of AMC1 NCC.GEN.130.

(c) Hazard identification and risk assessment

The operator should identify the safety hazards and manage the associated risks following the management system implemented in accordance with ORO.GEN.200. The risk assessment should include hazards associated with:

- (1) PEDs in different aircraft zones;
- (2) PED use during various phases of flight;
- (3) PED use during turbulence;
- (4) improperly stowed PEDs;
- (5) impeded or slowed evacuations;
- (6) passenger non-compliance, e.g. not deactivating transmitting functions, not switching off PEDs or not stowing PEDs properly;
- (7) disruptive passengers; and
- (8) battery fire.

(d) Use of PEDs in the passenger compartment

(1) Procedures and training

If an operator permits passengers to use PEDs on board its aircraft, procedures should be in place to control their use. These procedures should include provisions for passenger briefing, passenger handling and for the stowage of PEDs. The operator should ensure that all crew members and ground personnel are trained to enforce possible restrictions concerning the use of PEDs, in line with these procedures.

(2) Provisions for use

- (i) The use of PEDs in the passenger compartment may be granted under the responsibility of the operator, i.e. the operator decides which PED may be used during which phases of the flight.
- (ii) Notwithstanding (b), medical equipment necessary to support physiological functions may be used at all times and does not need to be switched-off.

- (3) Stowage, passenger information and passenger briefing of PEDs
- (i) In accordance with NCC.OP.135 the operator should establish procedures concerning the stowage of PEDs. The operator should:
 - (A) identify the phases of flight in which PEDs are to be stowed; and
 - (B) determine suitable stowage locations, taking into account the PEDs' size and weight.
 - (ii) The operator should provide general information on the use of PEDs to the passengers before the flight. This information should specify at least:
 - (A) which PEDs can be used during which phases of the flight;
 - (B) when and where PEDs are to be stowed; and
 - (C) that the instructions of the crew are to be followed at all times.
 - (iii) The use of PEDs should be part of the passenger briefings. The operator should remind passengers to pay attention and to avoid distraction during such briefings.

(4) In-seat electrical power supplies

Where in-seat electrical power supplies are available for passenger use, the following should apply:

- (i) information giving safety instructions should be provided to the passengers;
 - (ii) PEDs should be disconnected from any in-seat electrical power supply during taxiing, take-off, approach, landing, and during abnormal or emergency conditions; and
 - (iii) flight crew and cabin crew should be aware of the proper means to switch-off in-seat power supplies used for PEDs.
- (5) Operator's safety measures during boarding and any phase of flight
- (i) Appropriate coordination between flight crew and cabin crew should be established to deal with interference or other safety problems associated with PEDs.
 - (ii) Suspect equipment should be switched off.
 - (iii) Particular attention should be given to passenger misuse of equipment.
 - (iv) Thermal runaways of batteries, in particular lithium batteries, and potential resulting fire, should be handled properly.
 - (v) The pilot-in-command may, for any reason and during any phase of flight, require deactivation and stowage of PEDs.
 - (vi) When the operator restricts the use of PEDs, consideration should be given to handle special requests to operate a T-PED during any phase of the flight for specific reasons (e.g. for security measures).

(6) Reporting

Occurrences of suspected or confirmed interference should be reported to the competent authority. Where possible, to assist follow-up and technical investigation, reports should describe the suspected device, identify the brand name and model number, its location in the aircraft at the time of the occurrence, interference symptoms, the device user's contact details and the results of actions taken by the crew.

(e) Use of PEDs in the flight crew compartment

In the flight crew compartment the operator may permit the use of PEDs, e.g. to assist the flight crew in their duties, when procedures are in place to ensure the following:

- (1) The conditions for the use of PEDs in-flight are specified in the operations manual.
- (2) The PEDs do not pose a loose item risk or other hazard.
- (3) These provisions should not preclude use of a T-PED (specifically a mobile phone) by the flight crew to deal with an emergency. However, reliance should not be predicated on a T-PED for this purpose.

(f) PEDs not accessible during the flight

PEDs should be switched off, when not accessible for deactivation during flight. This should apply especially to PEDs contained in baggage or transported as part of the cargo. The operator may permit deviation for PEDs for which safe operation has been demonstrated in accordance with AMC1 NCC.GEN.130. Other precautions, such as transporting in shielded metal boxes, may also be used to mitigate associated risks.

GM1 NCC.GEN.130 Portable electronic devices

DEFINITIONS

(a) Definition and categories of PEDs

PEDs are any kind of electronic device, typically but not limited to consumer electronics, brought on board the aircraft by crew members, passengers, or as part of the cargo and that are not included in the approved aircraft configuration. All equipment that is able to consume electrical energy falls under this definition. The electrical energy can be provided from internal sources as batteries (chargeable or non-rechargeable) or the devices may also be connected to specific aircraft power sources.

PEDs include the following two categories:

- (1) Non-intentional transmitters can non-intentionally radiate RF transmissions, sometimes referred to as spurious emissions. This category includes, but is not limited to, calculators, cameras, radio receivers, audio and video players, electronic games and toys; when these devices are not equipped with a transmitting function.
- (2) Intentional transmitters radiate RF transmissions on specific frequencies as part of their intended function. In addition, they may radiate non-intentional transmissions like any PED. The term 'transmitting PED' (T-PED) is used to identify the transmitting capability of the PED. Intentional transmitters are transmitting devices such as RF-based remote control equipment, which may include some toys, two-way radios (sometimes referred to as private mobile radio), mobile phones of any type, satellite phones, computers with mobile phone data connection, wireless local area network (WLAN) or Bluetooth capability. After deactivation of the transmitting capability, e.g. by activating the so-called 'flight mode' or 'flight safety mode', the T-PED remains a PED having non-intentional emissions.

(b) Controlled PEDs (C-PEDs)

A controlled PED (C-PED) is a PED subject to administrative control by the operator using it. This will include, inter alia, tracking the allocation of the devices to specific aircraft or persons and ensuring that no unauthorised changes are made to the hardware, software or databases. C-PEDs can be assigned to the category of non-intentional transmitters or T-PEDs.

(c) Cargo tracking device

A cargo tracking device is a PED attached to or included in airfreight (e.g. in or on containers, pallets, parcels or baggage). Cargo tracking devices can be assigned to the category of non-intentional transmitters or T-PEDs. If the device is a T-PED, it complies with the European Norms (EN) for transmissions.

(d) Definition of the switched-off status

Many PEDs are not completely disconnected from the internal power source when switched off. The switching function may leave some remaining functionality, e.g. data storage, timer, clock, etc. These devices can be considered switched off when in the deactivated status. The same applies for devices having no transmitting capability and are operated by coin cells without further deactivation capability, e.g. wrist watches.

(e) Electromagnetic interference (EMI)

The two classes of EMI to be addressed can be described as follows:

- (1) Front door coupling is the possible disturbance to an aircraft system as received by the antenna of the system and mainly in the frequency band used by the system. Any PED internal oscillation has the potential to radiate low level signals in the aviation frequency bands. Through this disturbance especially the instrument landing system (ILS) and the VHF omni range (VOR) navigation system may indicate erroneous information.
- (2) Back door coupling is the possible disturbance of aircraft systems by electromagnetic fields generated by transmitters at a level which could exceed on short distance (i.e. within the aircraft) the electromagnetic field level used for the aircraft system certification. This disturbance may then lead to system malfunction.

GM2 NCC.GEN.130 Portable electronic devices

CREW REST COMPARTMENT, NAVIGATION, TEST ENTITIES AND FIRE CAUSED BY PEDS

- (a) When the aircraft is equipped with a crew rest compartment, it is considered being part of the passenger compartment.
- (b) Front door coupling may influence the VOR navigation system. Therefore, the flight crew monitors other navigation sensors to detect potential disturbances by PEDs, especially during low visibility departure operation based on VOR guidance.
- (c) Specific equipment, knowledge and experience are required, when the industry standards for evaluating technical prerequisites for the use of PEDs are applied. In order to ensure conformity with the industry standards, the operator is encouraged to cooperate with an appropriately qualified and experienced entity, as necessary. For this entity an aviation background is not required, but is considered to be beneficial.
- (d) Guidance to follow in case of fire caused by PEDs is provided by the International Civil Aviation Organisation, 'Emergency response guidance for aircraft incidents involving dangerous goods', ICAO Doc 9481-AN/928.

GM3 NCC.GEN.130 Portable electronic devices

CARGO TRACKING DEVICES EVALUATION

(a) Safety assessment

Further guidance on performing a safety assessment can be found in:

- (1) EASA, 'Certification specifications and acceptable means of compliance for large aeroplanes', CS-25, Book 2, AMC-Subpart F, AMC 25.1309;
- (2) EUROCAE/SAE, 'Guidelines for development of civil aircraft and systems', ED-79/ARP 4754 (or later revisions); and
- (3) SAE, 'Guidelines and methods for conducting the safety assessment process on civil airborne systems and equipment', ARP 4761 (or later revisions).

(b) HIRF certification

The type certificate data sheet (TCDS), available on the EASA website for each aircraft model having EASA certification, lists whether the HIRF certification has been performed through a special condition. The operator may contact the type certification holder to gain the necessary information.

(c) Failure mode and effects analysis

Further guidance on performing a failure mode and effects analysis can be found in:

- (1) SAE ARP 4761 (or later revisions); and
- (2) U.S. Department of Defense, 'Procedures for performing a failure mode, effects and criticality analysis', Military Standard MIL-STD-1629A (or later revisions).

NCC.GEN.135 Information on emergency and survival equipment carried

The operator shall at all times have available for immediate communication to rescue coordination centres (RCCs) lists containing information on the emergency and survival equipment carried on board.

AMC1 NCC.GEN.135 Information on emergency and survival equipment carried

CONTENT OF INFORMATION

The information, compiled in a list, should include, as applicable:

- (a) the number, colour and type of life-rafts and pyrotechnics;
- (b) details of emergency medical supplies and water supplies; and
- (c) the type and frequencies of the emergency portable radio equipment.

NCC.GEN.140 Documents, manuals and information to be carried

- (a) The following documents, manuals and information shall be carried on each flight as originals or copies unless otherwise specified:
- (1) the AFM, or equivalent document(s);
 - (2) the original certificate of registration;
 - (3) the original certificate of airworthiness (CofA);
 - (4) the noise certificate;
 - (5) the declaration as specified in Annex III (Part-ORO), ORO.DEC.100, to Regulation (EU) No 965/2012;
 - (6) the list of specific approvals, if applicable;
 - (7) the aircraft radio licence, if applicable;
 - (8) the third party liability insurance certificate(s);
 - (9) the journey log, or equivalent, for the aircraft;
 - (10) details of the filed ATS flight plan, if applicable;
 - (11) current and suitable aeronautical charts for the route of the proposed flight and all routes along which it is reasonable to expect that the flight may be diverted;
 - (12) procedures and visual signals information for use by intercepting and intercepted aircraft;
 - (13) information concerning search and rescue services for the area of the intended flight;
 - (14) the current parts of the operations manual that are relevant to the duties of the crew members, which shall be easily accessible to the crew members;
 - (15) the MEL or CDL;
 - (16) appropriate notices to airmen (NOTAMs) and aeronautical information service (AIS) briefing documentation;
 - (17) appropriate meteorological information;
 - (18) cargo and/or passenger manifests, if applicable; and
 - (19) any other documentation that may be pertinent to the flight or is required by the States concerned with the flight.
- (b) In case of loss or theft of documents specified in (a)(2) to (a)(8), the operation may continue until the flight reaches its destination or a place where replacement documents can be provided.

AMC1 NCC.GEN.140 Documents, manuals and information to be carried

GENERAL

The documents, manuals and information may be available in a form other than on printed paper. An electronic storage medium is acceptable if accessibility, usability and reliability can be assured.

AMC1 NCC.GEN.140(a)(3) Documents, manuals and information to be carried

CERTIFICATE OF AIRWORTHINESS

The certificate of airworthiness should be a normal certificate of airworthiness, a restricted certificate of airworthiness or a permit to fly issued in accordance with the applicable airworthiness requirements.

AMC1 NCC.GEN.140(a)(11) Documents, manuals and information to be carried

CURRENT AND SUITABLE AERONAUTICAL CHARTS

- (a) The aeronautical charts carried should contain data appropriate to the applicable air traffic regulations, rules of the air, flight altitudes, area/route and nature of the operation. Due consideration should be given to carriage of textual and graphic representations of:
- (1) aeronautical data including, as appropriate for the nature of the operation:
 - (i) airspace structure;
 - (ii) significant points, navigation aids (navaids) and air traffic services (ATS) routes;
 - (iii) navigation and communication frequencies;
 - (iv) prohibited, restricted and danger areas; and
 - (v) sites of other relevant activities that may hazard the flight; and
 - (2) topographical data, including terrain and obstacle data.
- (b) A combination of different charts and textual data may be used to provide adequate and current data.
- (c) The aeronautical data should be appropriate for the current aeronautical information regulation and control (AIRAC) cycle.
- (d) The topographical data should be reasonably recent, having regard to the nature of the planned operation.

AMC1 NCC.GEN.140(a)(12) Documents, manuals and information to be carried

PROCEDURES AND VISUAL SIGNALS FOR USE BY INTERCEPTING AND INTERCEPTED AIRCRAFT

The procedures and the visual signals information for use by intercepting and intercepted aircraft should reflect those contained in the International Civil Aviation Organisation's (ICAO) Annex 2. This may be part of the operations manual.

GM1 NCC.GEN.140(a)(1) Documents, manuals and information to be carried

AFM OR EQUIVALENT DOCUMENT

'Aircraft flight manual (AFM), or equivalent document' means the flight manual for the aircraft or other documents containing information required for the operation of the aircraft within the terms of its certificate of airworthiness, unless these data are available in the parts of the operations manual carried on board.

GM1 NCC.GEN.140(a)(9) Documents, manuals and information to be carried

JOURNEY LOG OR EQUIVALENT

'Journey log or equivalent' means in this context that the required information may be recorded in documentation other than a log book, such as the operational flight plan or the aircraft technical log.

GM1 NCC.GEN.140(a)(13) Documents, manuals and information to be carried

SEARCH AND RESCUE INFORMATION

This information is usually found in the State's aeronautical information publication.

GM1 NCC.GEN.140(a)(19) Documents, manuals and information to be carried

DOCUMENTS THAT MAY BE PERTINENT TO THE FLIGHT

Any other documents that may be pertinent to the flight or required by the States concerned with the flight may include, for example, forms to comply with reporting requirements.

STATES CONCERNED WITH THE FLIGHT

The States concerned are those of origin, transit, overflight and destination of the flight.

NCC.GEN.145 Handling of flight recorder recordings: Preservation, production, protection and use

- (a) Following an accident, a serious incident or an occurrence identified by the investigating authority, the operator of an aircraft shall preserve the original recorded data for a period of 60 days or until otherwise directed by the investigating authority.
- (b) The operator shall conduct operational checks and evaluations of flight data recorder (FDR) recordings, cockpit voice recorder (CVR) recordings and data link recordings to ensure the continued serviceability of the recorders.
- (c) The operator shall save the recordings for the period of operating time of the FDR as required by NCC.IDE.A.165 or NCC.IDE.H.165, except that, for the purpose of testing and maintaining the FDR, up to 1 hour of the oldest recorded material at the time of testing may be erased.
- (d) The operator shall keep and maintain up-to-date documentation that presents the necessary information to convert FDR raw data into parameters expressed in engineering units.
- (e) The operator shall make available any flight recorder recording that has been preserved, if so determined by the competent authority.
- (f) Without prejudice to Regulation (EU) No 996/2010:
 - (1) Except for ensuring the CVR serviceability, CVR recordings shall not be disclosed or used unless:
 - (i) a procedure related to the handling of CVR recordings and of their transcript is in place;
 - (ii) all crew members and maintenance personnel concerned have given their prior consent; and
 - (iii) they are used only for maintaining or improving safety.
 - (1a) When a CVR recording is inspected for ensuring the CVR serviceability, the operator shall ensure the privacy of the CVR recording and the CVR recording shall not be disclosed or used for other purposes than ensuring the CVR serviceability.
 - (2) FDR recordings or data link recordings shall only be used for purposes other than for the investigation of an accident or an incident which is subject to mandatory reporting, if such records are:
 - (i) used by the operator for airworthiness or maintenance purposes only;
 - (ii) de-identified; or
 - (iii) disclosed under secure procedures.

GM1 NCC.GEN.145(a) Handling of flight recorder recordings: preservation, production, protection and use**REMOVAL OF RECORDERS IN CASE OF AN INVESTIGATION**

The need for removal of the recorders from the aircraft is determined by the investigating authority with due regard to the seriousness of an occurrence and the circumstances, including the impact on the operation.

AMC1 NCC.GEN.145(a) Handling of flight recorder recordings: preservation, production, protection and use

PRESERVATION OF RECORDED DATA FOR INVESTIGATION

- (a) The operator should establish procedures to ensure that flight recorder recordings are preserved for the investigating authority.
- (b) These procedures should include:
 - (1) instructions for flight crew members to deactivate the flight recorders immediately after completion of the flight and inform relevant personnel that the recording of the flight recorders should be preserved. These instructions should be readily available on board; and
 - (2) instructions to prevent inadvertent reactivation, test, repair or reinstallation of the flight recorders by operator personnel or during maintenance or ground handling activities performed by third parties.

AMC1 NCC.GEN.145(b) Handling of flight recorder recordings: preservation, production, protection and use

INSPECTIONS AND CHECKS OF RECORDINGS

Whenever a flight recorder is required to be carried:

- (a) the operator should perform an inspection of the FDR recording and the CVR recording every year unless one or more of the following applies:
 - (1) If the flight recorder records on magnetic wire or uses frequency modulation technology, the time interval between two inspections of the recording should not exceed three months.
 - (2) If the flight recorder is solid-state and the flight recorder system is fitted with continuous monitoring for proper operation, the time interval between two inspections of the recording may be up to two years.
 - (3) In the case of an aircraft equipped with two solid-state flight data and cockpit voice combination recorders, where
 - (i) the flight recorder systems are fitted with continuous monitoring for proper operation, and
 - (ii) the flight recorders share the same flight data acquisition,a comprehensive inspection of the recording needs only to be performed for one flight recorder position. The inspection of the recordings should be performed alternately so that each flight recorder position is inspected at time intervals not exceeding four years.
 - (4) Where all of the following conditions are met, the inspection of FDR recording is not needed:
 - (i) the aircraft flight data are collected in the frame of a flight data monitoring (FDM) programme;
 - (ii) the data acquisition of mandatory flight parameters is the same for the FDR and for the recorder used for the FDM programme;
 - (iii) an inspection similar to the inspection of the FDR recording and covering all mandatory flight parameters is conducted on the FDM data at time intervals not exceeding two years; and

- (iv) the FDR is solid-state and the FDR system is fitted with continuous monitoring for proper operation.
- (b) the operator should perform every five years an inspection of the data link recording.
- (c) when installed, the aural or visual means for preflight checking the flight recorders for proper operation should be used every day. When no such means is available for a flight recorder, the operator should perform an operational check of this flight recorder at time intervals not exceeding seven calendar days of operation.
- (d) the operator should check every five years, or in accordance with the recommendations of the sensor manufacturer, that the parameters dedicated to the FDR and not monitored by other means are being recorded within the calibration tolerances and that there is no discrepancy in the engineering conversion routines for these parameters.

GM1 NCC.GEN.145(b) Handling of flight recorder recordings: preservation, production, protection and use

INSPECTION OF THE FLIGHT RECORDERS RECORDING

- (a) The inspection of the FDR recording usually consists of the following:
 - (1) Making a copy of the complete recording file.
 - (2) Converting the recording to parameters expressed in engineering units in accordance with the documentation required to be held.
 - (3) Examining a whole flight in engineering units to evaluate the validity of all mandatory parameters - this could reveal defects or noise in the measuring and processing chains and indicate necessary maintenance actions. The following should be considered:
 - (i) when applicable, each parameter should be expressed in engineering units and checked for different values of its operational range - for this purpose, some parameters may need to be inspected at different flight phases; and
 - (ii) if the parameter is delivered by a digital data bus and the same data are utilised for the operation of the aircraft, then a reasonableness check may be sufficient; otherwise a correlation check may need to be performed:
 - (A) a reasonableness check is understood in this context as a subjective, qualitative evaluation, requiring technical judgement, of the recordings from a complete flight; and
 - (B) a correlation check is understood in this context as the process of comparing data recorded by the flight data recorder against the corresponding data derived from flight instruments, indicators or the expected values obtained during specified portion(s) of a flight profile or during ground checks that are conducted for that purpose.
 - (4) Retaining the most recent copy of the complete recording file and the corresponding recording inspection report that includes references to the documentation required to be held.
- (b) When performing the CVR recording inspection, precautions need to be taken to comply with NCC.GEN.145(f)(1a). The inspection of the CVR recording usually consists of:
 - (1) checking that the CVR operates correctly for the nominal duration of the recording;

- (2) examining, where practicable, a sample of in-flight recording of the CVR for evidence that the signal is acceptable on each channel; and
 - (3) preparing and retaining an inspection report.
- (c) The inspection of the DLR recording usually consists of:
- (1) Checking the consistency of the data link recording with other recordings for example, during a designated flight, the flight crew speaks out a few data link messages sent and received. After the flight, the data link recording and the CVR recording are compared for consistency.
 - (2) Retaining the most recent copy of the complete recording and the corresponding inspection report.

GM2 NCC.GEN.145(b) Handling of flight recorder recordings: preservation, production, protection and use

MONITORING AND CHECKING THE PROPER OPERATION OF FLIGHT RECORDERS – EXPLANATION OF TERMS

For the understanding of the terms used in AMC1 NCC.GEN.145(b):

- (a) ‘operational check of the flight recorder’ means a check of the flight recorder for proper operation. It is not a check of the quality of the recording and, therefore, it is not equivalent to an inspection of the recording. This check can be carried out by the flight crew or through a maintenance task.
- (b) ‘aural or visual means for preflight checking the flight recorders for proper operation’ means an aural or visual means for the flight crew to check before the flight the results of an automatically or manually initiated test of the flight recorders for proper operation. Such a means provides for an operational check that can be performed by the flight crew.
- (c) ‘flight recorder system’ means the flight recorder, its dedicated sensors and transducers, as well as its dedicated acquisition and processing equipment.
- (d) ‘continuous monitoring for proper operation’ means for a flight recorder system, a combination of system monitors and/or built-in test functions which operates continuously in order to detect the following:
 - (1) loss of electrical power to the flight recorder system;
 - (2) failure of the equipment performing acquisition and processing;
 - (3) failure of the recording medium and/or drive mechanism; and
 - (4) failure of the recorder to store the data in the recording medium as shown by checks of the recorded data including, as reasonably practicable for the storage medium concerned, correct correspondence with the input data.

However, detections by the continuous monitoring for proper operation do not need to be automatically reported to the flight crew compartment.

GM3 NCC.GEN.145(b) Handling of flight recorder recordings: preservation, production, protection and use

CVR AUDIO QUALITY

Examples of CVR audio quality issues and possible causes thereof may be found in the document of the French Bureau d'Enquêtes et d'Analyses, titled 'Study on detection of audio anomalies on CVR recordings' and dated September 2015².

AMC1 NCC.GEN.145(f)(1) Handling of flight recorder recordings: preservation, production, protection and use

USE OF CVR RECORDINGS FOR MAINTAINING OR IMPROVING SAFETY

- (a) The procedure related to the handling of cockpit voice recorder (CVR) recordings should be written in a document which should be signed by all parties (aircraft operator, crew members, maintenance personnel if applicable). This procedure should, as a minimum, define:
- (1) the method to obtain the consent of all crew members and maintenance personnel concerned;
 - (2) an access and security policy that restricts access to CVR recordings and identified CVR transcripts to specifically authorised persons identified by their position;
 - (3) a retention policy and accountability, including the measures to be taken to ensure the security of the CVR recordings and CVR transcripts and their protection from misuse. The retention policy should specify the period of time after which CVR recordings and identified CVR transcripts are destroyed; and
 - (4) a description of the uses made of CVR recordings and of their transcripts.
- (b) Each time a CVR recording file is read out under the conditions defined by NCC.GEN.145(f)(1):
- (1) parts of the CVR recording file that contain information with a privacy content should be deleted to the extent possible, and it should not be permitted that the detail of information with a privacy content is transcribed; and
 - (2) the operator should retain, and when requested, provide to the competent authority:
 - (i) information on the use made (or the intended use) of the CVR recording; and
 - (ii) evidence that the persons concerned consented to the use made (or the intended use) of the CVR recording file.
- (c) The person who fulfils the role of a safety manager should also be responsible for the protection and use of the CVR recordings and the CVR transcripts.
- (d) In case a third party is involved in the use of CVR recordings, contractual agreements with this third party should, when applicable, cover the aspects enumerated in (a) and (b).

² <http://www.bea.aero/en/bea/la-technique/guidance.on.detection.of.audio.anomalies.on.CVR.recordings.pdf>

GM1 NCC.GEN.145(f)(1) Handling of flight recorder recordings: preservation, production, protection and use

USE OF CVR RECORDINGS FOR MAINTAINING OR IMPROVING SAFETY

- (a) The CVR is primarily a tool for the investigation of accidents and serious incidents by investigating authorities. Misuse of CVR recordings is a breach of the right to privacy and it works against an effective safety culture inside the operator.
- (b) Therefore, the use of a CVR recording, when for purposes other than CVR serviceability or those laid down by Regulation (EU) No 996/2010, should be subject to the free prior consent of the persons concerned, and framed by a procedure that is endorsed by all parties and that protects the privacy of crew members and (if applicable) maintenance staff.

AMC1 NCC.GEN.145(f)(1a) Handling of flight recorder recordings: preservation, production, protection and use

CVR RECORDING INSPECTION FOR ENSURING SERVICEABILITY

- (a) When an inspection of the CVR recording is performed for ensuring audio quality and intelligibility of recorded communications:
 - (1) the privacy of the CVR recording should be ensured (e.g. by locating the equipment in a separated area and/or using headsets);
 - (2) access to the CVR replay equipment should be restricted to specifically authorised persons;
 - (3) provision should be made for the secure storage of the CVR recording medium, the CVR recording files and copies thereof;
 - (4) the CVR recording files and copies thereof should be destroyed not earlier than two months and not later than one year after completion of the CVR recording inspection, except that audio samples may be retained for enhancing the CVR recording inspection (e.g. for comparing audio quality); and
 - (5) only the accountable manager of the operator, and when identified to comply with ORO.GEN.200, the person fulfilling the role of safety manager, should be entitled to request a copy of the CVR recording file.
- (b) The conditions enumerated in (a) should also be complied with if the inspection of the CVR recording is subcontracted to a third party. The contractual agreements with the third party should explicitly cover these aspects.

NCC.GEN.150 Transport of dangerous goods

- (a) The transport of dangerous goods by air shall be conducted in accordance with Annex 18 to the Chicago Convention as last amended and amplified by the *Technical Instructions for the Safe Transport of Dangerous Goods by Air* (ICAO Doc 9284-AN/905), including its supplements and any other addenda or corrigenda.
- (b) Dangerous goods shall only be transported by the operator approved in accordance with Annex V (Part-SPA), Subpart G, to Regulation (EU) No 965/2012 except when:
 - (1) they are not subject to the Technical Instructions in accordance with Part 1 of those Instructions; or
 - (2) they are carried by passengers or crew members, or are in baggage, in accordance with Part 8 of the Technical Instructions.
- (c) The operator shall establish procedures to ensure that all reasonable measures are taken to prevent dangerous goods from being carried on board inadvertently.
- (d) The operator shall provide personnel with the necessary information enabling them to carry out their responsibilities, as required by the Technical Instructions.
- (e) The operator shall, in accordance with the Technical Instructions, report without delay to the competent authority and the appropriate authority of the State of occurrence in the event of any dangerous goods accidents or incidents.
- (f) The operator shall ensure that passengers are provided with information about dangerous goods in accordance with the Technical Instructions.
- (g) The operator shall ensure that notices giving information about the transport of dangerous goods are provided at acceptance points for cargo as required by the Technical Instructions.

AMC1 NCC.GEN.150(e) Transport of dangerous goods**DANGEROUS GOODS ACCIDENT AND INCIDENT REPORTING**

- (a) Any type of dangerous goods accident or incident, or the finding of:
 - (1) undeclared or misdeclared dangerous goods in cargo;
 - (2) forbidden dangerous goods in mail; or
 - (3) forbidden dangerous goods in passenger or crew baggage, or on the person of a passenger or a crew membershould be reported. For this purpose, the Technical Instructions consider that reporting of undeclared and misdeclared dangerous goods found in cargo also applies to items of operators' stores that are classified as dangerous goods.
- (b) The first report should be dispatched within 72 hours of the event. It may be sent by any means, including e-mail, telephone or fax. This report should include the details that are known at that time, under the headings identified in (c). If necessary, a subsequent report should be made as soon as possible giving all the details that were not known at the time the first report was sent. If a report has been made verbally, written confirmation should be sent as soon as possible.
- (c) The first and any subsequent report should be as precise as possible and contain the following data, where relevant:
 - (1) date of the incident or accident or the finding of undeclared or misdeclared dangerous goods;

- (2) location and date of flight;
 - (3) description of the goods and the reference number of the air waybill, pouch, baggage tag, ticket, etc.;
 - (4) proper shipping name (including the technical name, if appropriate) and United Nations (UN)/identification (ID) number, when known;
 - (5) class or division and any subsidiary risk;
 - (6) type of packaging, and the packaging specification marking on it;
 - (7) quantity;
 - (8) name and address of the passenger, etc.;
 - (9) any other relevant details;
 - (10) suspected cause of the incident or accident;
 - (11) action taken;
 - (12) any other reporting action taken; and
 - (13) name, title, address and telephone number of the person making the report.
- (d) Copies of relevant documents and any photographs taken should be attached to the report.
- (e) A dangerous goods accident or incident may also constitute an aircraft accident, serious incident or incident. The criteria for reporting both types of occurrence should be met.
- (f) The following dangerous goods reporting form should be used, but other forms, including electronic transfer of data, may be used provided that at least the minimum information of this AMC is supplied:

DANGEROUS GOODS OCCURRENCE REPORT		DGOR No:
1. Operator:	2. Date of Occurrence:	3. Local time of occurrence:
4. Flight date:		
5. Departure aerodrome:	6. Destination aerodrome:	
7. Aircraft type:	8. Aircraft registration:	
9. Location of occurrence:	10. Origin of the goods:	
11. Description of the occurrence, including details of injury, damage, etc. (if necessary continue on the reverse of this form):		

12. Proper shipping name (including the technical name):			13. UN/ID No (when known):
14. Class/Division (when known):	15. Subsidiary risk(s):	16. Packing group:	17. Category (Class 7 only):
18. Type of packaging:	19. Packaging specification marking:	20. No of packages:	21. Quantity (or transport index, if applicable):
22. Name and address of passenger, etc.:			
23. Other relevant information (including suspected cause, any action taken):			
24. Name and title of person making report:		25. Telephone No:	
26. Company:		27. Reporters ref:	
28. Address:		29. Signature:	
		30. Date:	

Description of the occurrence (continuation)
--

Notes for completion of the form:

1. A dangerous goods accident is as defined in Annex I. For this purpose serious injury is as defined in Regulation (EU) No 996/2010 of the European Parliament and of the Council³.
2. The initial report should be dispatched unless exceptional circumstances prevent this. This occurrence report form, duly completed, should be sent as soon as possible, even if all the information is not available.
3. Copies of all relevant documents and any photographs should be attached to this report.
4. Any further information, or any information not included in the initial report, should be sent as soon as possible to the authorities identified in NCC.GEN.150(e).
5. Providing it is safe to do so, all dangerous goods, packagings, documents, etc. relating to the occurrence should be retained until after the initial report has been sent to the authorities identified in NCC.GEN.150(e), and they have indicated whether or not these should continue to be retained.

GM1 NCC.GEN.150 Transport of dangerous goods

GENERAL

- (a) The requirement to transport dangerous goods by air in accordance with the Technical Instructions is irrespective of whether:
 - (1) the flight is wholly or partly within or wholly outside the territory of a State; or
 - (2) an approval to carry dangerous goods in accordance with Annex V (Part-SPA), Subpart G is held.
- (b) The Technical Instructions provide that in certain circumstances dangerous goods, which are normally forbidden on an aircraft, may be carried. These circumstances include cases of extreme urgency or when other forms of transport are inappropriate or when full compliance with the prescribed requirements is contrary to the public interest. In these circumstances all the States concerned may grant exemptions from the provisions of the Technical Instructions provided that an overall level of safety that is at least equivalent to that provided by the Technical Instructions is achieved. Although exemptions are most likely to be granted for the carriage of dangerous goods that are not permitted in normal circumstances, they may also be granted in other circumstances,

³ OJ L 295, 12.11.2010, p. 35.

such as when the packaging to be used is not provided for by the appropriate packing method or the quantity in the packaging is greater than that permitted. The Technical Instructions also make provision for some dangerous goods to be carried when an approval has been granted only by the State of Origin and the competent authority.

- (c) When an exemption is required, the States concerned are those of origin, transit, overflight and destination of the consignment and that of the operator. For the State of overflight, if none of the criteria for granting an exemption are relevant, an exemption may be granted based solely on whether it is believed that an equivalent level of safety in air transport has been achieved.
- (d) The Technical Instructions provide that exemptions and approvals are granted by the ‘appropriate national authority’, which is intended to be the authority responsible for the particular aspect against which the exemption or approval is being sought. The operator should ensure that all relevant conditions on an exemption or approval are met.
- (e) The exemption or approval referred to in (b) to (d) is in addition to the approval required by Annex V (Part SPA), Subpart G.

SUBPART B: OPERATIONAL PROCEDURES

NCC.OP.100 Use of aerodromes and operating sites

The operator shall only use aerodromes and operating sites that are adequate for the type of aircraft and operation concerned.

AMC1 NCC.OP.100 Use of aerodromes and operating sites

USE OF OPERATING SITES

- (a) The pilot-in-command should have available from a pre-survey or other publication, for each operating site to be used, diagrams or ground and aerial photographs, depiction (pictorial) and description of:
- (1) the overall dimensions of the operating site;
 - (2) location and height of relevant obstacles to approach and take-off profiles and in the manoeuvring area;
 - (3) approach and take-off flight paths;
 - (4) surface condition (blowing dust/snow/sand);
 - (5) provision of control of third parties on the ground (if applicable);
 - (6) lighting, if applicable;
 - (7) procedure for activating the operating site in accordance with national regulations, if applicable;
 - (8) other useful information, for example details of the appropriate ATS agency and frequency; and
 - (9) site suitability with reference to available aircraft performance.
- (b) Where the operator specifically permits operation from sites that are not pre-surveyed, the pilot-in-command should make, from the air, a judgement on the suitability of a site. At least (a)(1) to (a)(6) inclusive and (a)(9) should be considered.

GM1 NCC.OP.100 Use of aerodromes and operating sites

PUBLICATIONS

'Other publication' mentioned in AMC1 NCC.OP.100 refers to publication means, such as:

- (a) civil as well as military aeronautical information publication;
- (b) visual flight rules (VFR) guides;
- (c) commercially available aeronautical publications; and
- (d) non-commercially available publications.

NCC.OP.105 Specification of isolated aerodromes — aeroplanes

For the selection of alternate aerodromes and the fuel policy, the operator shall consider an aerodrome as an isolated aerodrome if the flying time to the nearest adequate destination alternate aerodrome is more than:

- (a) for aeroplanes with reciprocating engines, 60 minutes; or
- (b) for aeroplanes with turbine engines, 90 minutes.

NCC.OP.110 Aerodrome operating minima — general

- (a) For instrument flight rules (IFR) flights the operator shall establish aerodrome operating minima for each departure, destination and alternate aerodrome to be used. Such minima shall:
 - (1) not be lower than those established by the State in which the aerodrome is located, except when specifically approved by that State; and
 - (2) when undertaking low visibility operations, be approved by the competent authority in accordance with Annex V (Part SPA), Subpart E to Regulation (EU) No 965/2012.
- (b) When establishing aerodrome operating minima, the operator shall take the following into account:
 - (1) the type, performance and handling characteristics of the aircraft;
 - (2) the composition, competence and experience of the flight crew;
 - (3) the dimensions and characteristics of the runways and final approach and take-off areas (FATOs) that may be selected for use;
 - (4) the adequacy and performance of the available visual and non-visual ground aids;
 - (5) the equipment available on the aircraft for the purpose of navigation and/or control of the flight path, during the take-off, the approach, the flare, the landing, the rollout and the missed approach;
 - (6) the obstacles in the approach, the missed approach and the climb-out areas necessary for the execution of contingency procedures;
 - (7) the obstacle clearance altitude/height for the instrument approach procedures;
 - (8) the means to determine and report meteorological conditions; and
 - (9) the flight technique to be used during the final approach.
- (c) The minima for a specific type of approach and landing procedure shall only be used if all the following conditions are met:
 - (1) the ground equipment required for the intended procedure is operative;
 - (2) the aircraft systems required for the type of approach are operative;
 - (3) the required aircraft performance criteria are met; and
 - (4) the crew is qualified appropriately.

AMC1 NCC.OP.110 Aerodrome operating minima — general

COMMERCIALY AVAILABLE INFORMATION

An acceptable method of specifying aerodrome operating minima is through the use of commercially available information.

AMC2 NCC.OP.110 Aerodrome operating minima — general

GENERAL

- (a) The aerodrome operating minima should not be lower than the values given in NCC.OP.111 or AMC3 NCC.OP.110 (c).
- (b) Whenever practical approaches should be flown as stabilised approaches (SAPs). Different procedures may be used for a particular approach to a particular runway.
- (c) Whenever practical, non-precision approaches should be flown using the continuous descent final approach (CDFA) technique. Different procedures may be used for a particular approach to a particular runway.
- (d) For approaches not flown using the CDFA technique: when calculating the minima in accordance with NCC.OP.111, the applicable minimum runway visual range (RVR) should be increased by 200 m for Category A and B aeroplanes and by 400 m for Category C and D aeroplanes, provided the resulting RVR/converted meteorological visibility (CMV) value does not exceed 5 000 m. SAP or CDFA should be used as soon as facilities are improved to allow these techniques.

AMC3 NCC.OP.110 Aerodrome operating minima — general

TAKE-OFF OPERATIONS

- (a) General:
 - (1) Take-off minima should be expressed as visibility (VIS) or RVR limits, taking into account all relevant factors for each aerodrome planned to be used and aircraft characteristics. Where there is a specific need to see and avoid obstacles on departure and/or for a forced landing, additional conditions, e.g. ceiling, should be specified.
 - (2) The pilot-in-command should not commence take-off unless the weather conditions at the aerodrome of departure are equal to or better than applicable minima for landing at that aerodrome, unless a weather-permissible take-off alternate aerodrome is available.
 - (3) When the reported meteorological visibility is below that required for take-off and RVR is not reported, a take-off should only be commenced if the pilot-in-command can determine that the visibility along the take-off runway/area is equal to or better than the required minimum.
 - (4) When no reported meteorological visibility or RVR is available, a take-off should only be commenced if the pilot-in-command can determine that the RVR/VIS along the take-off runway/area is equal to or better than the required minimum.
- (b) Visual reference:
 - (1) The take-off minima should be selected to ensure sufficient guidance to control the aircraft in the event of both a rejected take-off in adverse circumstances and a continued take-off after failure of the critical engine.

- (2) For night operations, ground lights should be available to illuminate the runway/final approach and take-off area (FATO) and any obstacles.
- (c) Required RVR/visibility:
- (1) Aeroplanes:
- (i) For aeroplanes, the take-off minima specified by the operator should be expressed as RVR/VIS values not lower than those specified in Table 1.A.
 - (ii) When reported RVR or meteorological visibility is not available, the pilot-in-command should not commence take-off unless he/she can determine that the actual conditions satisfy the applicable take-off minima.
- (2) Helicopters:
- (i) For helicopters having a mass where it is possible to reject the take-off and land on the FATO in case of the critical engine failure being recognised at or before the take-off decision point (TDP), the operator should specify an RVR/VIS as take-off minima in accordance with Table 1.H.
 - (ii) For all other cases, the pilot-in-command should operate to take-off minima of 800 m RVR/VIS and remain clear of cloud during the take-off manoeuvre until reaching the performance capabilities of (c)(2)(i).
 - (iii) Table 5 for converting reported meteorological visibility to RVR should not be used for calculating take-off minima.

**Table 1.A: Take-off — aeroplanes (without low visibility take-off (LVTO) approval)
RVR/VIS**

Facilities	RVR/VIS (m)*
Day only: Nil**	500
Day: at least runway edge lights or runway centreline markings Night: at least runway edge lights or runway centreline lights and runway end lights	400

*: The reported RVR/VIS value representative of the initial part of the take-off run can be replaced by pilot assessment.

** : The pilot is able to continuously identify the take-off surface and maintain directional control.

**Table 1.H: Take-off — helicopters (without LVTO approval)
RVR/Visibility**

Onshore aerodromes with instrument flight rules (IFR) departure procedures	RVR/VIS (m)
No light and no markings (day only)	400 or the rejected take-off distance, whichever is the greater
No markings (night)	800
Runway edge/FATO light and centreline marking	400
Runway edge/FATO light, centreline marking and relevant RVR information	400
Offshore helideck *	
Two-pilot operations	400
Single-pilot operations	500

*: The take-off flight path to be free of obstacles.

AMC4 NCC.OP.110 Aerodrome operating minima — general

CRITERIA FOR ESTABLISHING RVR/CMV

- (a) In order to qualify for the lowest allowable values of RVR/CMV specified in Table 4.A, the instrument approach should meet at least the following facility requirements and associated conditions:
- (1) Instrument approaches with designated vertical profile up to and including 4.5° for Category A and B aeroplanes, or 3.77° for Category C and D aeroplanes, where the facilities are:
 - (i) instrument landing system (ILS)/microwave landing system (MLS)/GBAS landing system (GLS)/precision approach radar (PAR); or
 - (ii) approach procedure with vertical guidance (APV); and
 where the final approach track is offset by not more than 15° for Category A and B aeroplanes or by not more than 5° for Category C and D aeroplanes.
 - (2) Instrument approach operations flown using the CDFA technique with a nominal vertical profile, up to and including 4.5° for Category A and B aeroplanes, or 3.77° for Category C and D aeroplanes, where the facilities are non-directional beacon (NDB), NDB/distance measuring equipment (DME), VHF omnidirectional radio range (VOR), VOR/DME, localiser (LOC), LOC/DME, VHF direction finder (VDF), surveillance radar approach (SRA) or global navigation satellite system (GNSS)/lateral navigation (LNAV), with a final approach segment of at least 3 NM, which also fulfil the following criteria:
 - (i) the final approach track is offset by not more than 15° for Category A and B aeroplanes or by not more than 5° for Category C and D aeroplanes;

- (ii) the final approach fix (FAF) or another appropriate fix where descent is initiated is available, or distance to threshold (THR) is available by flight management system (FMS)/area navigation (NDB/DME) or DME; and
 - (iii) the missed approach point (MAPt) is determined by timing, the distance from FAF to THR is ≤ 8 NM.
- (3) Instrument approaches where the facilities are NDB, NDB/DME, VOR, VOR/DME, LOC, LOC/DME, VDF, SRA or GNSS/LNAV, not fulfilling the criteria in (a)(2), or with a minimum descent height (MDH) $\geq 1\ 200$ ft.
- (b) The missed approach operation, after an approach operation has been flown using the CDFA technique, should be executed when reaching the decision height/altitude (DH/A) or the MAPt, whichever occurs first. The lateral part of the missed approach procedure should be flown via the MAPt unless otherwise stated on the approach chart.

AMC5 NCC.OP.110 Aerodrome operating minima – general

DETERMINATION OF RVR/CMV/VIS MINIMA FOR NPA, APV, CAT I – AEROPLANES

- (a) The minimum RVR/CMV/VIS should be the highest of the values specified in Table 3 and Table 4.A but not greater than the maximum values specified in Table 4.A, where applicable.
- (b) The values in Table 3 should be derived from the formula below:
- $$\text{required RVR/VIS (m)} = [(\text{DH/MDH (ft)} \times 0.3048) / \tan\alpha] - \text{length of approach lights (m)}$$
- where α is the calculation angle, being a default value of 3.00° increasing in steps of 0.10° for each line in Table 3 up to 3.77° and then remaining constant.
- (c) If the approach is flown with a level flight segment at or above MDA/H, 200 m should be added for Category A and B aeroplanes and 400 m for Category C and D aeroplanes to the minimum RVR/CMV/VIS value resulting from the application of Table 3 and Table 4.A.
- (d) An RVR of less than 750 m as indicated in Table 3 may be used:
- (1) for CAT I operations to runways with full approach lighting system (FALS), runway touchdown zone lights (RTZL) and runway centreline lights (RCLL);
 - (2) for CAT I operations to runways without RTZL and RCLL when using an approved head-up guidance landing system (HUDLS), or equivalent approved system, or when conducting a coupled approach or flight-director-flown approach to a DH. The ILS should not be published as a restricted facility; and
 - (3) for APV operations to runways with FALS, RTZL and RCLL when using an approved head-up display (HUD).
- (e) Lower values than those specified in Table 3 may be used for HUDLS and auto-land operations if approved in accordance with Annex V (Part SPA), Subpart E.
- (f) The visual aids should comprise standard runway day markings and approach and runway lights as specified in Table 2. The competent authority may approve that RVR values relevant to a basic approach lighting system (BALS) are used on runways where the approach lights are restricted in length below 210 m due to terrain or water, but where at least one cross-bar is available.
- (g) For night operations or for any operation where credit for runway and approach lights is required, the lights should be on and serviceable, except as provided for in Table 6.
- (h) For single-pilot operations, the minimum RVR/VIS should be calculated in accordance with the following additional criteria:

- (1) an RVR of less than 800 m as indicated in Table 3 may be used for CAT I approaches provided any of the following is used at least down to the applicable DH:
 - (i) a suitable autopilot, coupled to an ILS, MLS or GLS that is not published as restricted; or
 - (ii) an approved HUDLS, including, where appropriate, enhanced vision system (EVS), or equivalent approved system;
- (2) where RTZL and/or RCLL are not available, the minimum RVR/CMV should not be less than 600 m; and
- (3) an RVR of less than 800 m as indicated in Table 3 may be used for APV operations to runways with FALS, RTZL and RCLL when using an approved HUDLS, or equivalent approved system, or when conducting a coupled approach to a DH equal to or greater than 250 ft.

Table 2: Approach lighting systems

Class of lighting facility	Length, configuration and intensity of approach lights
FALS	CAT I lighting system (HIALS \geq 720 m) distance coded centreline, Barrette centreline
IALS	Simple approach lighting system (HIALS 420 – 719 m) single source, Barrette
BALS	Any other approach lighting system (HIALS, MIALS or ALS 210 – 419 m)
NALS	Any other approach lighting system (HIALS, MIALS or ALS < 210 m) or no approach lights

Note: HIALS: high intensity approach lighting system;
 MIALS: medium intensity approach lighting system;
 ALS: approach lighting system.

Table 3: RVR/CMV vs. DH/MDH

DH or MDH			Class of lighting facility			
			FALS	IALS	BALS	NALS
			See (d), (e), (h) above for RVR < 750/800 m			
ft			RVR/CMV (m)			
200	-	210	550	750	1 000	1 200
211	-	220	550	800	1 000	1 200
221	-	230	550	800	1 000	1 200
231	-	240	550	800	1 000	1 200

DH or MDH			Class of lighting facility			
			FALS	IALS	BALS	NALS
			See (d), (e), (h) above for RVR < 750/800 m			
ft			RVR/CMV (m)			
241	-	250	550	800	1 000	1 300
251	-	260	600	800	1 100	1 300
261	-	280	600	900	1 100	1 300
281	-	300	650	900	1 200	1 400
301	-	320	700	1 000	1 200	1 400
321	-	340	800	1 100	1 300	1 500
341	-	360	900	1 200	1 400	1 600
361	-	380	1 000	1 300	1 500	1 700
381	-	400	1 100	1 400	1 600	1 800
401	-	420	1 200	1 500	1 700	1 900
421	-	440	1 300	1 600	1 800	2 000
441	-	460	1 400	1 700	1 900	2 100
461	-	480	1 500	1 800	2 000	2 200
481		500	1 500	1 800	2 100	2 300
501	-	520	1 600	1 900	2 100	2 400
521	-	540	1 700	2 000	2 200	2 400
541	-	560	1 800	2 100	2 300	2 500
561	-	580	1 900	2 200	2 400	2 600
581	-	600	2 000	2 300	2 500	2 700
601	-	620	2 100	2 400	2 600	2 800
621	-	640	2 200	2 500	2 700	2 900
641	-	660	2 300	2 600	2 800	3 000

DH or MDH			Class of lighting facility			
			FALS	IALS	BALS	NALS
			See (d), (e), (h) above for RVR < 750/800 m			
ft			RVR/CMV (m)			
661	-	680	2 400	2 700	2 900	3 100
681	-	700	2 500	2 800	3 000	3 200
701	-	720	2 600	2 900	3 100	3 300
721	-	740	2 700	3 000	3 200	3 400
741	-	760	2 700	3 000	3 300	3 500
761	-	800	2 900	3 200	3 400	3 600
801	-	850	3 100	3 400	3 600	3 800
851	-	900	3 300	3 600	3 800	4 000
901	-	950	3 600	3 900	4 100	4 300
951	-	1 000	3 800	4 100	4 300	4 500
1 001	-	1 100	4 100	4 400	4 600	4 900
1 101	-	1 200	4 600	4 900	5 000	5 000
1 201 and above			5 000	5 000	5 000	5 000

Table 4.A: CAT I, APV, NPA - aeroplanes**Minimum and maximum applicable RVR/CMV (lower and upper cut-off limits)**

Facility/conditions	RVR/CMV (m)	Aeroplane category			
		A	B	C	D
ILS, MLS, GLS, PAR, GNSS/SBAS, GNSS/VNAV	Min	According to Table 3			
	Max	1 500	1 500	2 400	2 400
NDB, NDB/DME, VOR, VOR/DME, LOC, LOC/DME, VDF, SRA, GNSS/LNAV with a procedure that fulfils the criteria in AMC4 NCC.OP.110 (a)(2).	Min	750	750	750	750
	Max	1 500	1 500	2 400	2 400
For NDB, NDB/DME, VOR, VOR/DME, LOC, LOC/DME, VDF, SRA, GNSS/LNAV: — not fulfilling the criteria in AMC4 NCC.OP.110 (a)(2)., or — with a DH or MDH \geq 1 200 ft	Min	1 000	1 000	1 200	1 200
	Max	According to Table 3 if flown using the CDFA technique, otherwise an add-on of 200/400 m applies to the values in Table 3 but not to result in a value exceeding 5 000 m.			

AMC6 NCC.OP.110 Aerodrome operating minima — general

DETERMINATION OF RVR/CMV/VIS MINIMA FOR NPA, CAT I — HELICOPTERS

- (a) For non-precision approach (NPA) operations the minima specified in Table 4.1.H should apply:
- (1) where the missed approach point is within $\frac{1}{2}$ NM of the landing threshold, the approach minima specified for FALS may be used regardless of the length of approach lights available. However, FATO/runway edge lights, threshold lights, end lights and FATO/runway markings are still required;
 - (2) for night operations, ground lights should be available to illuminate the FATO/runway and any obstacles; and
 - (3) for single-pilot operations, the minimum RVR is 800 m or the minima in Table 4.2.H, whichever is higher.
- (b) For CAT I operations, the minima specified in Table 4.2.H should apply:
- (1) for night operations, ground light should be available to illuminate the FATO/runway and any obstacles;
 - (2) for single-pilot operations, the minimum RVR/VIS should be calculated in accordance with the following additional criteria:
 - (i) an RVR of less than 800 m should not be used except when using a suitable autopilot coupled to an ILS, MLS or GLS, in which case normal minima apply; and

- (ii) the DH applied should not be less than 1.25 times the minimum use height for the autopilot.

Table 4.1.H : Onshore NPA minima

MDH (ft) *	Facilities vs. RVR/CMV (m) **, ***			
	FALS	IALS	BALS	NALS
250 – 299	600	800	1 000	1 000
300 – 449	800	1 000	1 000	1 000
450 and above	1 000	1 000	1 000	1 000

*: The MDH refers to the initial calculation of MDH. When selecting the associated RVR, there is no need to take account of a rounding up to the nearest 10 ft, which may be done for operational purposes, e.g. conversion to MDA.

** : The tables are only applicable to conventional approaches with a nominal descent slope of not greater than 4°. Greater descent slopes will usually require that visual glide slope guidance (e.g. precision path approach indicator (PAPI)) is also visible at the MDH.

***: FALS comprise FATO/runway markings, 720 m or more of high intensity/medium intensity (HI/MI) approach lights, FATO/runway edge lights, threshold lights and FATO/runway end lights. Lights to be on.

IALS comprise FATO/runway markings, 420 – 719 m of HI/MI approach lights, FATO/runway edge lights, threshold lights and FATO/runway end lights. Lights to be on.

BALS comprise FATO/runway markings, < 420 m of HI/MI approach lights, any length of low intensity (LI) approach lights, FATO/runway edge lights, threshold lights and FATO/runway end lights. Lights to be on.

NALS comprise FATO/runway markings, FATO/runway edge lights, threshold lights, FATO/runway end lights or no lights at all.

Table 4.2.H: Onshore CAT I minima

DH (ft) *	Facilities vs. RVR/CMV (m) **, ***			
	FALS	IALS	BALS	NALS
200	500	600	700	1 000
201 – 250	550	650	750	1 000
251 – 300	600	700	800	1 000
301 and above	750	800	900	1 000

*: The DH refers to the initial calculation of DH. When selecting the associated RVR, there is no need to take account of a rounding up to the nearest 10 ft, which may be done for operational purposes, e.g. conversion to DA.

** : The table is applicable to conventional approaches with a glide slope up to and including 4°.

***: FALS comprise FATO/runway markings, 720 m or more of HI/MI approach lights, FATO/runway edge lights, threshold lights and FATO/runway end lights. Lights to be on.

IALS comprise FATO/runway markings, 420 – 719 m of HI/MI approach lights, FATO/runway edge lights, threshold lights and FATO/runway end lights. Lights to be on.

BALS comprise FATO/runway markings, < 420 m of HI/MI approach lights, any length of LI approach lights, FATO/runway edge lights, threshold lights and FATO/runway end lights. Lights to be on.

NALS comprise FATO/runway markings, FATO/runway edge lights, threshold lights, FATO/runway end lights or no lights at all.

AMC7 NCC.OP.110 Aerodrome operating minima — general

VISUAL APPROACH OPERATIONS

For a visual approach operation the RVR should not be less than 800 m.

AMC8 NCC.OP.110 Aerodrome operating minima — general

CONVERSION OF REPORTED METEOROLOGICAL VISIBILITY TO RVR/CMV

- (a) A conversion from meteorological visibility to RVR/CMV should not be used:
- (1) when reported RVR is available;
 - (2) for calculating take-off minima; and
 - (3) for other RVR minima less than 800 m.
- (b) If the RVR is reported as being above the maximum value assessed by the aerodrome operator, e.g. 'RVR more than 1 500 m', it should not be considered as a reported value for (a)(1).
- (c) When converting meteorological visibility to RVR in circumstances other than those in (a), the conversion factors specified in Table 5 should be used.

Table 5 : Conversion of reported meteorological visibility to RVR/CMV

Light elements in operation	RVR/CMV = reported meteorological visibility x	
	Day	Night
HI approach and runway lights	1.5	2.0
Any type of light installation other than above	1.0	1.5
No lights	1.0	not applicable

AMC9 NCC.OP.110 Aerodrome operating minima — general

EFFECT ON LANDING MINIMA OF TEMPORARILY FAILED OR DOWNGRADED GROUND EQUIPMENT

- (a) General

These instructions are intended for both pre-flight and in-flight use. It is, however, not expected that the pilot-in-command would consult such instructions after passing 1 000 ft above the aerodrome. If failures of ground aids are announced at such a late stage, the approach could be continued at the pilot-in-command's discretion. If failures are announced before such a late stage in the approach, their effect on the approach should be considered as described in Table 6 and, if considered necessary, the approach should be abandoned.

(b) Conditions applicable to Table 6:

- (1) multiple failures of runway/FATO lights other than indicated in Table 6 should not be acceptable;
- (2) deficiencies of approach and runway/FATO lights are treated separately; and
- (3) failures other than ILS, MLS affect RVR only and not DH.

Table 6 : Failed or downgraded equipment — effect on landing minima

Failed or downgraded equipment	Effect on landing minima	
	CAT I	APV, NPA
ILS/MLS standby transmitter	No effect	
Outer marker	No effect if replaced by height check at 1 000 ft	APV — not applicable
		NPA with FAF: no effect unless used as FAF
		If the FAF cannot be identified (e.g. no method available for timing of descent), non-precision operations cannot be conducted
Middle marker	No effect	No effect unless used as MAPt
RVR Assessment Systems	No effect	
Approach lights	Minima as for NALS	
Approach lights except the last 210 m	Minima as for BALS	
Approach lights except the last 420 m	Minima as for IALS	
Standby power for approach lights	No effect	
Edge lights, threshold lights and runway end lights	Day — no effect Night — not allowed	

Failed or downgraded equipment	Effect on landing minima	
	CAT I	APV, NPA
Centreline lights	No effect if flight director (F/D), HUDLS or auto-land; otherwise RVR 750 m	No effect
Centreline lights spacing increased to 30 m	No effect	
Touchdown zone lights	No effect if F/D, HUDLS or auto-land; otherwise RVR 750 m	No effect
Taxiway lighting system	No effect	

GM1 NCC.OP.110 Aerodrome operating minima — general

AIRCRAFT CATEGORIES

- (a) Aircraft categories should be based on the indicated airspeed at threshold (V_{AT}), which is equal to the stalling speed (V_{SO}) multiplied by 1.3 or where published 1-g (gravity) stall speed (V_{S1g}) multiplied by 1.23 in the landing configuration at the maximum certified landing mass. If both V_{SO} and V_{S1g} are available, the higher resulting V_{AT} should be used.
- (b) The aircraft categories specified in the following table should be used.

Table 1: Aircraft categories corresponding to V_{AT} values

Aircraft category	V_{AT}
A	Less than 91 kt
B	from 91 to 120 kt
C	from 121 to 140 kt
D	from 141 to 165 kt
E	from 166 to 210 kt

GM2 NCC.OP.110 Aerodrome operating minima — general

CONTINUOUS DESCENT FINAL APPROACH (CDFA) — AEROPLANES

- (a) Introduction

- (1) Controlled flight into terrain (CFIT) is a major hazard in aviation. Most CFIT accidents occur in the final approach segment of non-precision approaches; the use of stabilised-approach criteria on a continuous descent with a constant, predetermined vertical path is seen as a major improvement in safety during the conduct of such approaches. Operators should ensure that the following techniques are adopted as widely as possible, for all approaches.
 - (2) The elimination of level flight segments at MDA close to the ground during approaches, and the avoidance of major changes in attitude and power/thrust close to the runway that can destabilise approaches, are seen as ways to reduce operational risks significantly.
 - (3) The term CDFA has been selected to cover a flight technique for any type of NPA operation.
 - (4) The advantages of CDFA are as follows:
 - (i) the technique enhances safe approach operations by the utilisation of standard operating practices;
 - (ii) the technique is similar to that used when flying an ILS approach, including when executing the missed approach and the associated missed approach procedure manoeuvre;
 - (iii) the aeroplane attitude may enable better acquisition of visual cues;
 - (iv) the technique may reduce pilot workload;
 - (v) the approach profile is fuel-efficient;
 - (vi) the approach profile affords reduced noise levels;
 - (vii) the technique affords procedural integration with APV operations; and
 - (viii) when used and the approach is flown in a stabilised manner, CDFA is the safest approach technique for all NPA operations.
- (b) CDFA
- (1) Continuous descent final approach is defined in Annex I to the Regulation on Air Operations.
 - (2) An approach is only suitable for application of a CDFA technique when it is flown along a nominal vertical profile; a nominal vertical profile is not forming part of the approach procedure design, but can be flown as a continuous descent. The nominal vertical profile information may be published or displayed on the approach chart to the pilot by depicting the nominal slope or range/distance vs. height. Approaches with a nominal vertical profile are considered to be:
 - (i) NDB, NDB/DME (non-directional beacon/distance measuring equipment);
 - (ii) VOR (VHF omnidirectional radio range), VOR/DME;
 - (iii) LOC (localiser), LOC/DME;
 - (iv) VDF (VHF direction finder), SRA (surveillance radar approach); or
 - (v) GNSS/LNAV (global navigation satellite system/lateral navigation);
 - (3) Stabilised approach (SAp) is defined in Annex I to the Regulation on Air Operations.
 - (i) The control of the descent path is not the only consideration when using the CDFA technique. Control of the aeroplane's configuration and energy is also vital to the safe conduct of an approach.
 - (ii) The control of the flight path, described above as one of the requirements for conducting an SAp, should not be confused with the path requirements for using the

CDFA technique. The predetermined path requirements for conducting an SAp are established by the operator and published in the operations manual part B.

- (iii) The predetermined approach slope requirements for applying the CDFA technique are established by the following:
 - (A) the published 'nominal' slope information when the approach has a nominal vertical profile; and
 - (B) the designated final approach segment minimum of 3 NM, and maximum, when using timing techniques, of 8 NM.
- (iv) An SAp will never have any level segment of flight at DA/H or MDA/H, as applicable. This enhances safety by mandating a prompt missed approach procedure manoeuvre at DA/H or MDA/H.
- (v) An approach using the CDFA technique will always be flown as an SAp, since this is a requirement for applying CDFA. However, an SAp does not have to be flown using the CDFA technique, for example a visual approach.

GM3 NCC.OP.110 Aerodrome operating minima — general

TAKE-OFF MINIMA — HELICOPTERS

To ensure sufficient control of the helicopter in IMC, the speed, before entering in IMC, should be above the minimum authorised speed in IMC, V_{mini} . This is a limitation in the AFM. Therefore, the lowest speed before entering in IMC is the highest of V_{toss} (take-off safety speed) and V_{mini} .

As example, V_{toss} is 45 kt and V_{mini} 60 kt. In that case, the take-off minima have to include the distance to accelerate to 60 kt. The take-off distance should be increased accordingly.

NCC.OP.111 Aerodrome operating minima — NPA, APV, CAT I operations

- (a) The decision height (DH) to be used for a non-precision approach (NPA) flown with the continuous descent final approach (CDFA) technique, approach procedure with vertical guidance (APV) or category I (CAT I) operation shall not be lower than the highest of:
- (1) the minimum height to which the approach aid can be used without the required visual reference;
 - (2) the obstacle clearance height (OCH) for the category of aircraft;
 - (3) the published approach procedure DH where applicable;
 - (4) the system minimum specified in Table 1; or
 - (5) the minimum DH specified in the AFM or equivalent document, if stated.
- (b) The minimum descent height (MDH) for an NPA operation flown without the CDFA technique shall not be lower than the highest of:
- (1) the OCH for the category of aircraft;
 - (2) the system minimum specified in Table 1; or
 - (3) the minimum MDH specified in the AFM, if stated.

Table 1**System minima**

Facility	Lowest DH/MDH (ft)
Instrument landing system (ILS)	200
Global navigation satellite system (GNSS)/Satellite-based augmentation system (SBAS) (Lateral precision with vertical guidance approach (LPV))	200
GNSS (Lateral Navigation (LNAV))	250
GNSS/Baro-vertical navigation (VNAV) (LNAV/VNAV)	250
Localiser (LOC) with or without distance measuring equipment (DME)	250
Surveillance radar approach (SRA) (terminating at ½ NM)	250
SRA (terminating at 1 NM)	300
SRA (terminating at 2 NM or more)	350
VHF omnidirectional radio range (VOR)	300
VOR/DME	250
Non-directional beacon (NDB)	350
NDB/DME	300
VHF direction finder (VDF)	350

AMC1 NCC.OP.111 Aerodrome operating minima — NPA, APV, CAT I operations

NPA FLOWN WITH THE CDFA TECHNIQUE

The DA/DH used should take into account any add-on to the published minima as identified by the operator's management system and specified in the operations manual (aerodrome operating minima).

NCC.OP.112 Aerodrome operating minima — circling operations with aeroplanes

- (a) The MDH for a circling operation with aeroplanes shall not be lower than the highest of:
- (1) the published circling OCH for the aeroplane category;
 - (2) the minimum circling height derived from Table 1; or
 - (3) the DH/MDH of the preceding instrument approach procedure.
- (b) The minimum visibility for a circling operation with aeroplanes shall be the highest of:
- (1) the circling visibility for the aeroplane category, if published;
 - (2) the minimum visibility derived from Table 2; or
 - (3) the runway visual range/converted meteorological visibility (RVR/CMV) of the preceding instrument approach procedure.

Table 1**MDH and minimum visibility for circling vs. aeroplane category**

	Aeroplane category			
	A	B	C	D
MDH (ft)	400	500	600	700
Minimum meteorological visibility (m)	1500	1600	2400	3600

GM1 NCC.OP.112 Aerodrome operating minima — circling operations with aeroplanes

SUPPLEMENTAL INFORMATION

- (a) The purpose of this Guidance Material is to provide operators with supplemental information regarding the application of aerodrome operating minima in relation to circling approaches.
- (b) Conduct of flight — general:
- (1) the MDH and obstacle clearance height (OCH) included in the procedure are referenced to aerodrome elevation;
 - (2) the MDA is referenced to mean sea level;
 - (3) for these procedures, the applicable visibility is the meteorological visibility; and
 - (4) operators should provide tabular guidance of the relationship between height above threshold and the in-flight visibility required to obtain and sustain visual contact during the circling manoeuvre.
- (c) Instrument approach followed by visual manoeuvring (circling) without prescribed tracks:
- (1) When the aeroplane is on the initial instrument approach, before visual reference is stabilised, but not below MDA/H — the aeroplane should follow the corresponding instrument approach procedure until the appropriate instrument MAPt is reached.
 - (2) At the beginning of the level flight phase at or above the MDA/H, the instrument approach track determined by the radio navigation aids, RNAV, RNP, ILS, MLS or GLS should be maintained until the pilot:

- (i) estimates that, in all probability, visual contact with the runway of intended landing or the runway environment will be maintained during the entire circling procedure;
 - (ii) estimates that the aeroplane is within the circling area before commencing circling; and
 - (iii) is able to determine the aeroplane's position in relation to the runway of intended landing with the aid of the appropriate external references.
 - (3) When reaching the published instrument MAPt and the conditions stipulated in (c)(2) are unable to be established by the pilot, a missed approach should be carried out in accordance with that instrument approach procedure.
 - (4) After the aeroplane has left the track of the initial instrument approach, the flight phase outbound from the runway should be limited to an appropriate distance, which is required to align the aeroplane onto the final approach. Such manoeuvres should be conducted to enable the aeroplane:
 - (i) to attain a controlled and stable descent path to the intended landing runway; and
 - (ii) to remain within the circling area and in a such way that visual contact with the runway of intended landing or runway environment is maintained at all times.
 - (5) Flight manoeuvres should be carried out at an altitude/height that is not less than the circling MDA/H.
 - (6) Descent below MDA/H should not be initiated until the threshold of the runway to be used has been appropriately identified. The aeroplane should be in a position to continue with a normal rate of descent and land within the touchdown zone.
- (d) Instrument approach followed by a visual manoeuvring (circling) with prescribed track.
- (1) The aeroplane should remain on the initial instrument approach procedure until one of the following is reached:
 - (i) the prescribed divergence point to commence circling on the prescribed track; or
 - (ii) the MAPt.
 - (2) The aeroplane should be established on the instrument approach track determined by the radio navigation aids, RNAV, RNP, ILS, MLS or GLS in level flight at or above the MDA/H at or by the circling manoeuvre divergence point.
 - (3) If the divergence point is reached before the required visual reference is acquired, a missed approach should be initiated not later than the MAPt and completed in accordance with the initial instrument approach procedure.
 - (4) When commencing the prescribed circling manoeuvre at the published divergence point, the subsequent manoeuvres should be conducted to comply with the published routing and published heights/altitudes.
 - (5) Unless otherwise specified, once the aeroplane is established on the prescribed track(s), the published visual reference does not need to be maintained unless:
 - (i) required by the State of the aerodrome; or
 - (ii) the circling MAPt (if published) is reached.
 - (6) If the prescribed circling manoeuvre has a published MAPt and the required visual reference has not been obtained by that point, a missed approach should be executed in accordance with (e)(2) and (e)(3).

- (7) Subsequent further descent below MDA/H should only commence when the required visual reference has been obtained.
 - (8) Unless otherwise specified in the procedure, final descent should not be commenced from MDA/H until the threshold of the intended landing runway has been identified and the aeroplane is in a position to continue with a normal rate of descent to land within the touchdown zone.
- (e) Missed approach
- (1) Missed approach during the instrument procedure prior to circling:
 - (i) if the missed approach procedure is required to be flown when the aeroplane is positioned on the instrument approach track defined by radio navigation aids; RNAV, RNP, ILS, MLS or GLS, and before commencing the circling manoeuvre, the published missed approach for the instrument approach should be followed; or
 - (ii) if the instrument approach procedure is carried out with the aid of an ILS, MLS or a stabilised approach (SAP), the MAPt associated with an ILS or MLS procedure without glide path (GP-out procedure) or the SAP, where applicable, should be used.
 - (2) If a prescribed missed approach is published for the circling manoeuvre, this overrides the manoeuvres prescribed below.
 - (3) If visual reference is lost while circling to land after the aeroplane has departed from the initial instrument approach track, the missed approach specified for that particular instrument approach should be followed. It is expected that the pilot will make an initial climbing turn toward the intended landing runway to a position overhead of the aerodrome where the pilot will establish the aeroplane in a climb on the instrument missed approach segment.
 - (4) The aeroplane should not leave the visual manoeuvring (circling) area, which is obstacle protected, unless:
 - (i) established on the appropriate missed approach procedure; or
 - (ii) at minimum sector altitude (MSA).
 - (5) All turns should be made in the same direction and the aeroplane should remain within the circling protected area while climbing either:
 - (i) to the altitude assigned to any published circling missed approach manoeuvre if applicable;
 - (ii) to the altitude assigned to the missed approach of the initial instrument approach;
 - (iii) to the MSA;
 - (iv) to the minimum holding altitude (MHA) applicable for transition to a holding facility or fix, or continue to climb to an MSA; or
 - (v) as directed by ATS.

When the missed approach procedure is commenced on the 'downwind' leg of the circling manoeuvre, an 'S' turn may be undertaken to align the aeroplane on the initial instrument approach missed approach path, provided the aeroplane remains within the protected circling area.

The pilot-in-command should be responsible for ensuring adequate terrain clearance during the above-stipulated manoeuvres, particularly during the execution of a missed approach initiated by ATS.

-
- (6) Because the circling manoeuvre may be accomplished in more than one direction, different patterns will be required to establish the aeroplane on the prescribed missed approach course depending on its position at the time visual reference is lost. In particular, all turns are to be in the prescribed direction if this is restricted, e.g. to the west/east (left or right hand) to remain within the protected circling area.
 - (7) If a missed approach procedure is published for a particular runway onto which the aeroplane is conducting a circling approach and the aeroplane has commenced a manoeuvre to align with the runway, the missed approach for this direction may be accomplished. The ATS unit should be informed of the intention to fly the published missed approach procedure for that particular runway.
 - (8) The pilot-in-command should advise ATS when any missed approach procedure has been commenced, the height/altitude the aeroplane is climbing to and the position the aeroplane is proceeding towards and/or heading the aeroplane is established on.

NCC.OP.113 Aerodrome operating minima — onshore circling operations with helicopters

The MDH for an onshore circling operation with helicopters shall not be lower than 250 ft and the meteorological visibility not less than 800 m.

NCC.OP.115 Departure and approach procedures

- (a) The pilot-in-command shall use the departure and approach procedures established by the State of the aerodrome, if such procedures have been published for the runway or FATO to be used.
- (b) Notwithstanding (a), the pilot-in-command shall only accept an ATC clearance to deviate from a published procedure:
 - (1) provided that obstacle clearance criteria are observed and full account is taken of the operating conditions; or
 - (2) when being radar-vectorred by an ATC unit.
- (c) In any case, the final approach segment shall be flown visually or in accordance with the published approach procedures.

NCC.OP.116 Performance-based navigation — aeroplanes and helicopters

The operator shall ensure that, when PBN is required for the route or procedure to be flown:

- (a) the relevant PBN specification is stated in the AFM or other document that has been approved by the certifying authority as part of an airworthiness assessment or is based on such approval; and
- (b) the aircraft is operated in conformance with the relevant navigation specification and limitations in the AFM or other document mentioned above.

AMC1 NCC.OP.116 Performance-based navigation — aeroplanes and helicopters**PBN OPERATIONS**

For operations where a navigation specification for performance-based navigation (PBN) has been prescribed and no specific approval is required in accordance with SPA.PBN.100, the operator should:

- (a) establish operating procedures specifying:
 - (1) normal, abnormal and contingency procedures;
 - (2) electronic navigation database management; and
 - (3) relevant entries in the minimum equipment list (MEL);
- (b) specify the flight crew qualification and proficiency constraints and ensure that the training programme for relevant personnel is consistent with the intended operation; and
- (c) ensure continued airworthiness of the area navigation system.

AMC2 NCC.OP.116 Performance-based navigation — aeroplanes and helicopters**MONITORING AND VERIFICATION**

- (a) Preflight and general considerations
 - (1) At navigation system initialisation, the flight crew should confirm that the navigation database is current and verify that the aircraft position has been entered correctly, if required.

- (2) The active flight plan, if applicable, should be checked by comparing the charts or other applicable documents with navigation equipment and displays. This includes confirmation of the departing runway and the waypoint sequence, reasonableness of track angles and distances, any altitude or speed constraints, and, where possible, which waypoints are fly-by and which are fly-over. Where relevant, the RF leg arc radii should be confirmed.
 - (3) The flight crew should check that the navigation aids critical to the operation of the intended PBN procedure are available.
 - (4) The flight crew should confirm the navigation aids that should be excluded from the operation, if any.
 - (5) An arrival, approach or departure procedure should not be used if the validity of the procedure in the navigation database has expired.
 - (6) The flight crew should verify that the navigation systems required for the intended operation are operational.
- (b) Departure
- (1) Prior to commencing a take-off on a PBN procedure, the flight crew should check that the indicated aircraft position is consistent with the actual aircraft position at the start of the take-off roll (aeroplanes) or lift-off (helicopters).
 - (2) Where GNSS is used, the signal should be acquired before the take-off roll (aeroplanes) or lift-off (helicopters) commences.
 - (3) Unless automatic updating of the actual departure point is provided, the flight crew should ensure initialisation on the runway or FATO by means of a manual runway threshold or intersection update, as applicable. This is to preclude any inappropriate or inadvertent position shift after take-off.
- (c) Arrival and approach
- (1) The flight crew should verify that the navigation system is operating correctly and the correct arrival procedure and runway (including any applicable transition) are entered and properly depicted.
 - (2) Any published altitude and speed constraints should be observed.
 - (3) The flight crew should check approach procedures (including alternate aerodromes if needed) as extracted by the system (e.g. CDU flight plan page) or presented graphically on the moving map, in order to confirm the correct loading and the reasonableness of the procedure content.
 - (4) Prior to commencing the approach operation (before the IAF), the flight crew should verify the correctness of the loaded procedure by comparison with the appropriate approach charts. This check should include:
 - (i) the waypoint sequence;
 - (ii) reasonableness of the tracks and distances of the approach legs and the accuracy of the inbound course; and
 - (iii) the vertical path angle, if applicable.
- (d) Altimetry settings for RNP APCH operations using Baro VNAV
- (1) Barometric settings

- (i) The flight crew should set and confirm the correct altimeter setting and check that the two altimeters provide altitude values that do not differ more than 100 ft at the most at or before the FAF.
- (ii) The flight crew should fly the procedure with:
 - (A) a current local altimeter setting source available — a remote or regional altimeter setting source should not be used; and
 - (B) the QNH/QFE, as appropriate, set on the aircraft's altimeters.
- (2) Temperature compensation
 - (i) For RNP APCH operations to LNAV/VNAV minima using Baro VNAV:
 - (A) the flight crew should not commence the approach when the aerodrome temperature is outside the promulgated aerodrome temperature limits for the procedure unless the area navigation system is equipped with approved temperature compensation for the final approach;
 - (B) when the temperature is within promulgated limits, the flight crew should not make compensation to the altitude at the FAF and DA/H;
 - (C) since only the final approach segment is protected by the promulgated aerodrome temperature limits, the flight crew should consider the effect of temperature on terrain and obstacle clearance in other phases of flight.
 - (ii) For RNP APCH operations to LNAV minima, the flight crew should consider the effect of temperature on terrain and obstacle clearance in all phases of flight, in particular on any step-down fix.
- (e) Sensor and lateral navigation accuracy selection
 - (1) For multi-sensor systems, the flight crew should verify, prior to approach, that the GNSS sensor is used for position computation.
 - (2) Flight crew of aircraft with RNP input selection capability should confirm that the indicated RNP value is appropriate for the PBN operation.

AMC3 NCC.OP.116 Performance-based navigation — aeroplanes and helicopters

MANAGEMENT OF THE NAVIGATION DATABASE

- (a) For RNAV 1, RNAV 2, RNP 1, RNP 2, and RNP APCH, the flight crew should neither insert nor modify waypoints by manual entry into a procedure (departure, arrival or approach) that has been retrieved from the database. User-defined data may be entered and used for waypoint altitude/speed constraints on a procedure where said constraints are not included in the navigation database coding.
- (b) For RNP 4 operations, the flight crew should not modify waypoints that have been retrieved from the database. User-defined data (e.g. for flex-track routes) may be entered and used.
- (c) The lateral and vertical definition of the flight path between the FAF and the missed approach point (MAPt) retrieved from the database should not be revised by the flight crew.

AMC4 NCC.OP.116 Performance-based navigation — aeroplanes and helicopters

DISPLAYS AND AUTOMATION

- (a) For RNAV 1, RNP 1, and RNP APCH operations, the flight crew should use a lateral deviation indicator, and where available, flight director and/or autopilot in lateral navigation mode.
- (b) The appropriate displays should be selected so that the following information can be monitored:
 - (1) the computed desired path;
 - (2) aircraft position relative to the lateral path (cross-track deviation) for FTE monitoring;
 - (3) aircraft position relative to the vertical path (for a 3D operation).
- (c) The flight crew of an aircraft with a lateral deviation indicator (e.g. CDI) should ensure that lateral deviation indicator scaling (full-scale deflection) is suitable for the navigation accuracy associated with the various segments of the procedure.
- (d) The flight crew should maintain procedure centrelines unless authorised to deviate by ATC or demanded by emergency conditions.
- (e) Cross-track error/deviation (the difference between the area-navigation-system-computed path and the aircraft-computed position) should normally be limited to $\pm \frac{1}{2}$ time the RNAV/RNP value associated with the procedure. Brief deviations from this standard (e.g. overshoots or undershoots during and immediately after turns) up to a maximum of 1 time the RNAV/RNP value should be allowable.
- (f) For a 3D approach operation, the flight crew should use a vertical deviation indicator and, where required by AFM limitations, a flight director or autopilot in vertical navigation mode.
- (g) Deviations below the vertical path should not exceed 75 ft at any time, or half-scale deflection where angular deviation is indicated, and not more than 75 ft above the vertical profile, or half-scale deflection where angular deviation is indicated, at or below 1 000 ft above aerodrome level. The flight crew should execute a missed approach if the vertical deviation exceeds this criterion, unless the flight crew has in sight the visual references required to continue the approach.

AMC5 NCC.OP.116 Performance-based navigation — aeroplanes and helicopters

VECTORIZING AND POSITIONING

- (a) ATC tactical interventions in the terminal area may include radar headings, 'direct to' clearances which bypass the initial legs of an approach procedure, interceptions of an initial or intermediate segments of an approach procedure or the insertion of additional waypoints loaded from the database.
- (b) In complying with ATC instructions, the flight crew should be aware of the implications for the navigation system.
- (c) 'Direct to' clearances may be accepted to the IF provided that it is clear to the flight crew that the aircraft will be established on the final approach track at least 2 NM before the FAF.
- (d) 'Direct to' clearance to the FAF should not be acceptable. Modifying the procedure to intercept the final approach track prior to the FAF should be acceptable for radar-vector arrivals or otherwise only with ATC approval.
- (e) The final approach trajectory should be intercepted no later than the FAF in order for the aircraft to be correctly established on the final approach track before starting the descent (to ensure terrain and obstacle clearance).

- (f) 'Direct to' clearances to a fix that immediately precede an RF leg should not be permitted.
- (g) For parallel offset operations en route in RNP 4 and A-RNP, transitions to and from the offset track should maintain an intercept angle of no more than 45° unless specified otherwise by ATC.

AMC6 NCC.OP.116 Performance-based navigation — aeroplanes and helicopters

ALERTING AND ABORT

- (a) Unless the flight crew has sufficient visual reference to continue the approach operation to a safe landing, an RNP APCH operation should be discontinued if:
 - (1) navigation system failure is annunciated (e.g. warning flag);
 - (2) lateral or vertical deviations exceed the tolerances;
 - (3) loss of the on-board monitoring and alerting system.
- (b) Discontinuing the approach operation may not be necessary for a multi-sensor navigation system that includes demonstrated RNP capability without GNSS in accordance with the AFM.
- (c) Where vertical guidance is lost while the aircraft is still above 1 000 ft AGL, the flight crew may decide to continue the approach to LNAV minima, when supported by the navigation system.

AMC7 NCC.OP.116 Performance-based navigation — aeroplanes and helicopters

CONTINGENCY PROCEDURES

- (a) The flight crew should make the necessary preparation to revert to a conventional arrival procedure where appropriate. The following conditions should be considered:
 - (1) failure of the navigation system components including navigation sensors, and a failure effecting flight technical error (e.g. failures of the flight director or autopilot);
 - (2) multiple system failures affecting aircraft performance;
 - (3) coasting on inertial sensors beyond a specified time limit; and
 - (4) RAIM (or equivalent) alert or loss of integrity function.
- (b) In the event of loss of PBN capability, the flight crew should invoke contingency procedures and navigate using an alternative means of navigation.
- (c) The flight crew should notify ATC of any problem with PBN capability.
- (d) In the event of communication failure, the flight crew should continue with the operation in accordance with published lost communication procedures.

AMC8 NCC.OP.116 Performance-based navigation — aeroplanes and helicopters

RNAV 10

- (a) Operating procedures and routes should take account of the RNAV 10 time limit declared for the inertial system, if applicable, considering also the effect of weather conditions that could affect flight duration in RNAV 10 airspace.
- (b) The operator may extend RNAV 10 inertial navigation time by position updating. The operator should calculate, using statistically-based typical wind scenarios for each planned route, points at which updates can be made, and the points at which further updates will not be possible.

GM1 NCC.OP.116 Performance-based navigation — aeroplanes and helicopters

DESCRIPTION

- (a) For both, RNP X and RNAV X designations, the 'X' (where stated) refers to the lateral navigation accuracy (total system error) in NM, which is expected to be achieved at least 95 % of the flight time by the population of aircraft operating within the airspace, route or procedure. For RNP APCH and A-RNP, the lateral navigation accuracy depends on the segment.
- (b) PBN may be required on notified routes, for notified procedures and in notified airspace.

RNAV 10

- (c) For purposes of consistency with the PBN concept, this Regulation is using the designation 'RNAV 10' because this specification does not include on-board performance monitoring and alerting.
- (d) However, it should be noted that many routes still use the designation 'RNP 10' instead of 'RNAV 10'. 'RNP 10' was used as designation before the publication of the fourth edition of ICAO Doc 9613 in 2013. The terms 'RNP 10' and 'RNAV 10' should be considered equivalent.

NCC.OP.120 Noise abatement procedures

The operator shall develop operating procedures taking into account the need to minimise the effect of aircraft noise while ensuring that safety has priority over noise abatement.

AMC1 NCC.OP.120 Noise abatement procedures

NADP DESIGN

- (a) For each aeroplane type two departure procedures should be defined, in accordance with ICAO Doc. 8168 (Procedures for Air Navigation Services, 'PANS-OPS'), Volume I:
 - (1) noise abatement departure procedure one (NADP 1), designed to meet the close-in noise abatement objective; and
 - (2) noise abatement departure procedure two (NADP 2), designed to meet the distant noise abatement objective.
- (b) For each type of NADP (1 and 2), a single climb profile should be specified for use at all aerodromes, which is associated with a single sequence of actions. The NADP 1 and NADP 2 profiles may be identical.

GM1 NCC.OP.120 Noise abatement procedures

TERMINOLOGY

- (a) 'Climb profile' means in this context the vertical path of the NADP as it results from the pilot's actions (engine power reduction, acceleration, slats/flaps retraction).
- (b) 'Sequence of actions' means the order in which these pilot's actions are done and their timing.

GENERAL

- (c) The rule addresses only the vertical profile of the departure procedure. Lateral track has to comply with the standard instrument departure (SID).

EXAMPLE

- (d) For a given aeroplane type, when establishing the distant NADP, the operator should choose either to reduce power first and then accelerate, or to accelerate first and then wait until slats/flaps are retracted before reducing power. The two methods constitute two different sequences of actions.
- (e) For an aeroplane type, each of the two departure climb profiles may be defined by one sequence of actions (one for close-in, one for distant) and two above aerodrome level (AAL) altitudes/heights. These are:
 - (1) the altitude of the first pilot's action (generally power reduction with or without acceleration). This altitude should not be less than 800 ft AAL; or
 - (2) the altitude of the end of the noise abatement procedure. This altitude should usually not be more than 3 000 ft AAL.

These two altitudes may be runway specific when the aeroplane flight management system (FMS) has the relevant function that permits the crew to change thrust reduction and/or acceleration altitude/height. If the aeroplane is not FMS equipped or the FMS is not fitted with the relevant function, two fixed heights should be defined and used for each of the two NADPs.

NCC.OP.125 Minimum obstacle clearance altitudes — IFR flights

- (a) The operator shall specify a method to establish minimum flight altitudes that provide the required terrain clearance for all route segments to be flown in IFR.
- (b) The pilot-in-command shall establish minimum flight altitudes for each flight based on this method. The minimum flight altitudes shall not be lower than that published by the State overflown.

AMC1 NCC.OP.125 Minimum obstacle clearance altitudes — IFR flights

GENERAL

Commercially available information specifying minimum obstacle clearance altitudes may be used.

NCC.OP.130 Fuel and oil supply — aeroplanes

- (a) The pilot-in-command shall only commence a flight if the aeroplane carries sufficient fuel and oil for the following:
- (1) for visual flight rules (VFR) flights:
 - (i) by day, to fly to the aerodrome of intended landing and thereafter to fly for at least 30 minutes at normal cruising altitude; or
 - (ii) by night, to fly to the aerodrome of intended landing and thereafter to fly for at least 45 minutes at normal cruising altitude;
 - (2) for IFR flights:
 - (i) when no destination alternate is required, to fly to the aerodrome of intended landing, and thereafter to fly for at least 45 minutes at normal cruising altitude; or
 - (ii) when a destination alternate is required, to fly to the aerodrome of intended landing, to an alternate aerodrome and thereafter to fly for at least 45 minutes at normal cruising altitude.
- (b) In computing the fuel required including to provide for contingency, the following shall be taken into consideration:
- (1) forecast meteorological conditions;
 - (2) anticipated ATC routings and traffic delays;
 - (3) procedures for loss of pressurisation or failure of one engine while en-route, where applicable; and
 - (4) any other condition that may delay the landing of the aeroplane or increase fuel and/or oil consumption.
- (c) Nothing shall preclude amendment of a flight plan in-flight, in order to re-plan the flight to another destination, provided that all requirements can be complied with from the point where the flight is re-planned.

NCC.OP.131 Fuel and oil supply — helicopters

- (a) The pilot-in-command shall only commence a flight if the helicopter carries sufficient fuel and oil for the following:
- (1) for VFR flights, to fly to the aerodrome/operating site of intended landing and thereafter to fly for at least 20 minutes at best-range-speed; and
 - (2) for IFR flights:
 - (i) when no alternate is required or no weather-permissible alternate aerodrome is available, to fly to the aerodrome/operating site of intended landing, and thereafter to fly for 30 minutes at holding speed at 450 m (1 500 ft) above the destination aerodrome/operating site under standard temperature conditions and approach and land; or
 - (ii) when an alternate is required, to fly to and execute an approach and a missed approach at the aerodrome/operating site of intended landing, and thereafter:
 - (A) to fly to the specified alternate; and

- (B) to fly for 30 minutes at holding speed at 450 m (1 500 ft) above the alternate aerodrome/operating site under standard temperature conditions and approach and land.
- (b) In computing the fuel required including to provide for contingency, the following shall be taken into consideration:
- (1) forecast meteorological conditions;
 - (2) anticipated ATC routings and traffic delays;
 - (3) procedures for loss of pressurisation or failure of one engine while en-route, where applicable; and
 - (4) any other condition that may delay the landing of the aircraft or increase fuel and/or oil consumption.
- (c) Nothing shall preclude amendment of a flight plan in-flight, in order to re-plan the flight to another destination, provided that all requirements can be complied with from the point where the flight is re-planned.

NCC.OP.135 Stowage of baggage and cargo

The operator shall establish procedures to ensure that:

- (a) only hand baggage that can be adequately and securely stowed is taken into the passenger compartment; and
- (b) all baggage and cargo on board that might cause injury or damage, or obstruct aisles and exits if displaced, is stowed so as to prevent movement.

NCC.OP.140 Passenger briefing

The pilot-in-command shall ensure that:

- (a) prior to take-off passengers have been made familiar with the location and use of the following:
 - (1) seat belts;
 - (2) emergency exits; and
 - (3) passenger emergency briefing cards;and if applicable:
 - (4) life-jackets;
 - (5) oxygen dispensing equipment;
 - (6) life-rafts; and
 - (7) other emergency equipment provided for individual passenger use;and
- (b) in an emergency during flight, passengers are instructed in such emergency action as may be appropriate to the circumstances.

AMC1 NCC.OP.140 Passenger briefing

TRAINING PROGRAMME

- (a) The operator may replace the briefing/demonstration with a passenger training programme covering all safety and emergency procedures for a given type of aircraft.
- (b) Only passengers who have been trained according to this programme and have flown on the aircraft type within the last 90 days may be carried on board without receiving a briefing/demonstration.

NCC.OP.145 Flight preparation

- (a) Before commencing a flight, the pilot-in-command shall ascertain by every reasonable means available that the space-based facilities, ground and/or water facilities, including communication facilities and navigation aids available and directly required on such flight, for the safe operation of the aircraft, are adequate for the type of operation under which the flight is to be conducted.
- (b) Before commencing a flight, the pilot-in-command shall be familiar with all available meteorological information appropriate to the intended flight. Preparation for a flight away from the vicinity of the place of departure, and for every flight under IFR, shall include:
 - (1) a study of available current weather reports and forecasts; and
 - (2) the planning of an alternative course of action to provide for the eventuality that the flight cannot be completed as planned, because of weather conditions.

GM1 NCC.OP.145(b) Flight preparation

OPERATIONAL FLIGHT PLAN

- (a) Dependent on the length and complexity of the planned flight, an operational flight plan may be completed based on considerations of aircraft performance, other operating limitations and relevant expected conditions on the route to be followed and at the aerodromes/operating sites concerned.
- (b) The operational flight plan used and the entries made during flight may contain the following items:
 - (1) aircraft registration;
 - (2) aircraft type and variant;
 - (3) date of flight;
 - (4) flight identification;
 - (5) names of flight crew members;
 - (6) duty assignment of flight crew members;
 - (7) place of departure;
 - (8) time of departure (actual off-block time, take-off time);
 - (9) place of arrival (planned and actual);
 - (10) time of arrival (actual landing and on-block time);
 - (11) type of operation (VFR, ferry flight, etc.);
 - (12) route and route segments with checkpoints/waypoints, distances, time and tracks;
 - (13) planned cruising speed and flying times between check-points/waypoints (estimated and actual times overhead);
 - (14) safe altitudes and minimum levels;
 - (15) planned altitudes and flight levels;
 - (16) fuel calculations (records of in-flight fuel checks);
 - (17) fuel on board when starting engines;
 - (18) alternate(s) for destination and, where applicable, take-off and en-route;

- (19) initial ATS flight plan clearance and subsequent reclearance;
- (20) in-flight replanning calculations; and
- (21) relevant meteorological information.

NCC.OP.150 Take-off alternate aerodromes — aeroplanes

- (a) For IFR flights, the pilot-in-command shall specify at least one weather-permissible take-off alternate aerodrome in the flight plan if the weather conditions at the aerodrome of departure are at or below the applicable aerodrome operating minima or it would not be possible to return to the aerodrome of departure for other reasons.
- (b) The take-off alternate aerodrome shall be located within the following distance from the aerodrome of departure:
 - (1) for aeroplanes having two engines, not more than a distance equivalent to a flight time of 1 hour at the single-engine cruise speed in still air standard conditions; and
 - (2) for aeroplanes having three or more engines, not more than a distance equivalent to a flight time of 2 hours at the one-engine-inoperative (OEI) cruise speed according to the AFM in still air standard conditions.
- (c) For an aerodrome to be selected as a take-off alternate aerodrome the available information shall indicate that, at the estimated time of use, the conditions will be at or above the aerodrome operating minima for that operation.

NCC.OP.151 Destination alternate aerodromes — aeroplanes

For IFR flights, the pilot-in-command shall specify at least one weather-permissible destination alternate aerodrome in the flight plan, unless:

- (a) the available current meteorological information indicates that, for the period from 1 hour before until 1 hour after the estimated time of arrival, or from the actual time of departure to 1 hour after the estimated time of arrival, whichever is the shorter period, the approach and landing may be made under visual meteorological conditions (VMC); or
- (b) the place of intended landing is isolated and:
 - (1) an instrument approach procedure is prescribed for the aerodrome of intended landing; and
 - (2) available current meteorological information indicates that the following meteorological conditions will exist from 2 hours before to 2 hours after the estimated time of arrival:
 - (i) a cloud base of at least 300 m (1 000 ft) above the minimum associated with the instrument approach procedure; and
 - (ii) visibility of at least 5,5 km or of 4 km more than the minimum associated with the procedure.

NCC.OP.152 Destination alternate aerodromes — helicopters

For IFR flights, the pilot-in-command shall specify at least one weather-permissible destination alternate in the flight plan, unless:

- (a) an instrument approach procedure is prescribed for the aerodrome of intended landing and the available current meteorological information indicates that the following meteorological conditions will exist from 2 hours before to 2 hours after the estimated time of arrival, or from the actual time of departure to 2 hours after the estimated time of arrival, whichever is the shorter period:
 - (1) a cloud base of at least 120 m (400 ft) above the minimum associated with the instrument approach procedure; and

- (2) visibility of at least 1500 m more than the minimum associated with the procedure; or
- (b) the place of intended landing is isolated and:
- (1) an instrument approach procedure is prescribed for the aerodrome of intended landing;
 - (2) available current meteorological information indicates that the following meteorological conditions will exist from 2 hours before to 2 hours after the estimated time of arrival:
 - (i) the cloud base is at least 120 m (400 ft) above the minimum associated with the instrument approach procedure;
 - (ii) visibility is at least 1 500 m more than the minimum associated with the procedure; and
 - (3) a point of no return (PNR) is determined in case of an offshore destination.

Grey text shall be applicable until 01 July 2018, then deleted.

AMC1 NCC.OP.152 Destination alternate aerodromes — helicopters

OFFSHORE ALTERNATE AERODROMES

- (a) Weather-permissible offshore alternate aerodromes may be selected and specified subject to the following:
- (1) the offshore alternate aerodrome should only be used after passing a point of no return (PNR). Prior to a PNR, onshore alternate aerodromes should be used;
 - (2) mechanical reliability of critical control systems and critical components should be considered and taken into account when determining the suitability of the alternate aerodrome;
 - (3) one-engine-inoperative (OEI) performance capability should be attainable prior to arrival at the alternate;
 - (4) to the extent possible, deck availability should be guaranteed; and
 - (5) weather information should be reliable and accurate.
- (b) Offshore alternate aerodromes should not be used when it is possible to carry enough fuel to have an onshore alternate aerodrome. Offshore alternate aerodromes should not be used in a hostile environment.
- (c) The landing technique specified in the AFM following control system failure may preclude the nomination of certain helidecks as alternate aerodromes.

This AMC is applicable until 01 July 2018, then deleted.

NCC.OP.153 Destination aerodromes — instrument approach operations

The pilot-in-command shall ensure that sufficient means are available to navigate and land at the destination aerodrome or at any destination alternate aerodrome in the case of loss of capability for the intended approach and landing operation.

AMC1 NCC.OP.153 Destination aerodromes — instrument approach operations

PBN OPERATIONS

The pilot-in-command should only select an aerodrome as a destination alternate aerodrome if an instrument approach procedure that does not rely on GNSS is available either at that aerodrome or at the destination aerodrome.

GM1 NCC.OP.153 Destination aerodromes — instrument approach operations

INTENT OF AMC1

- (a) The limitation applies only to destination alternate aerodromes for flights when a destination alternate aerodrome is required. A take-off or en route alternate aerodrome with instrument approach procedures relying on GNSS may be planned without restrictions. A destination aerodrome with all instrument approach procedures relying solely on GNSS may be used without a destination alternate aerodrome if the conditions for a flight without a destination alternate aerodrome are met.
- (b) The term 'available' means that the procedure can be used in the planning stage and complies with planning minima requirements.

NCC.OP.155 Refuelling with passengers embarking, on board or disembarking

- (a) The aircraft shall not be refuelled with aviation gasoline (AVGAS) or wide-cut type fuel or a mixture of these types of fuel, when passengers are embarking, on board or disembarking.
- (b) For all other types of fuel, necessary precautions shall be taken and the aircraft shall be properly manned by qualified personnel ready to initiate and direct an evacuation of the aircraft by the most practical and expeditious means available.

AMC1 NCC.OP.155 Refuelling with passengers embarking, on board or disembarking

OPERATIONAL PROCEDURES — GENERAL

- (a) If passengers are on board when refuelling with:
 - (1) other than aviation gasoline (AVGAS); or
 - (2) wide-cut type fuel; or
 - (3) a mixture of these types of fuel,ground servicing activities and work inside the aeroplane, such as catering and cleaning, should be conducted in such a manner that they do not create a hazard and allow emergency evacuation to take place through those aisles and exits intended for emergency evacuation.
- (b) The deployment of integral aircraft stairs or the opening of emergency exits as a prerequisite to refuelling is not necessarily required.

OPERATIONAL PROCEDURES — AEROPLANES

- (c) Operational procedures should specify that at least the following precautions are taken:
 - (1) one qualified person should remain at a specified location during fuelling operations with passengers on board. This qualified person should be capable of handling emergency procedures concerning fire protection and fire-fighting, handling communications and initiating and directing an evacuation;
 - (2) two-way communication should be established and should remain available by the aeroplane's inter-communication system or other suitable means between the ground crew supervising the refuelling and the qualified personnel on board the aeroplane; the involved personnel should remain within easy reach of the system of communication;
 - (3) crew members, personnel and passengers should be warned that refuelling will take place;
 - (4) 'fasten seat belts' signs should be off;
 - (5) 'no smoking' signs should be on, together with interior lighting to enable emergency exits to be identified;
 - (6) passengers should be instructed to unfasten their seat belts and refrain from smoking;
 - (7) the minimum required number of cabin crew should be on board and be prepared for an immediate emergency evacuation;
 - (8) if the presence of fuel vapour is detected inside the aeroplane, or any other hazard arises during refuelling, fuelling should be stopped immediately;
 - (9) the ground area beneath the exits intended for emergency evacuation and slide deployment areas, if applicable, should be kept clear at doors where stairs are not in position for use in the event of evacuation; and

- (10) provision should be made for a safe and rapid evacuation.

OPERATIONAL PROCEDURES — HELICOPTERS

- (d) Operational procedures should specify that at least the following precautions are taken:
- (1) door(s) on the refuelling side of the helicopter remain closed;
 - (2) door(s) on the non-refuelling side of the helicopter remain open, weather permitting;
 - (3) fire fighting facilities of the appropriate scale be positioned so as to be immediately available in the event of a fire;
 - (4) sufficient personnel should be immediately available to move passengers clear of the helicopter in the event of a fire;
 - (5) sufficient qualified personnel be on board and be prepared for an immediate emergency evacuation;
 - (6) if the presence of fuel vapour is detected inside the helicopter, or any other hazard arises during refuelling, fuelling should be stopped immediately;
 - (7) the ground area beneath the exits intended for emergency evacuation be kept clear; and
 - (8) provision should be made for a safe and rapid evacuation.

GM1 NCC.OP.155 Refuelling with passengers embarking, on board or disembarking

AIRCRAFT REFUELLING PROVISIONS AND GUIDANCE ON SAFE REFUELLING PRACTICES

Provisions concerning aircraft refuelling are contained in Volume I (Aerodrome Design and Operations) of ICAO Annex 14 (Aerodromes), and guidance on safe refuelling practices is contained in Parts 1 and 8 of the ICAO Airport Services Manual (Doc 9137).

NCC.OP.160 Use of headset

- (a) Each flight crew member required to be on duty in the flight crew compartment shall wear a headset with boom microphone or equivalent. The headset shall be used as the primary device for voice communications with ATS:
- (1) when on the ground:
 - (i) when receiving the ATC departure clearance via voice communication; and
 - (ii) when engines are running;
 - (2) when in flight:
 - (i) below transition altitude; or
 - (ii) 10 000 ft, whichever is higher;and
 - (3) whenever deemed necessary by the pilot in command.
- (b) In the conditions of (a), the boom microphone or equivalent shall be in a position that permits its use for two-way radio communications.

NCC.OP.165 Carriage of passengers

The operator shall establish procedures to ensure that:

- (a) passengers are seated where, in the event that an emergency evacuation is required, they are able to assist and not hinder evacuation of the aircraft;
- (b) prior to and during taxiing, take-off and landing, and whenever deemed necessary in the interest of safety by the pilot-in-command, each passenger on board occupies a seat or berth and has his/her safety belt or restraint device properly secured; and
- (c) multiple occupancy is only allowed on specified aircraft seats occupied by one adult and one infant properly secured by a supplementary loop belt or other restraint device.

AMC1 NCC.OP.165 Carriage of passengers**SEATS THAT PERMIT DIRECT ACCESS TO EMERGENCY EXITS**

Passengers who occupy seats that permit direct access to emergency exits should appear to be reasonably fit, strong and able to assist the rapid evacuation of the aircraft in an emergency after an appropriate briefing by the crew.

GM1 NCC.OP.165 Carriage of passengers**MEANING OF DIRECT ACCESS**

‘Direct access’ means a seat from which a passenger can proceed directly to the exit without entering an aisle or passing around an obstruction.

NCC.OP.170 Securing of passenger compartment and galley(s)

The pilot-in-command shall ensure that:

- (a) before taxiing, take-off and landing, all exits and escape paths are unobstructed; and
- (b) before take-off and landing, and whenever deemed necessary in the interest of safety, all equipment and baggage are properly secured.

NCC.OP.175 Smoking on board

The pilot-in-command shall not allow smoking on board:

- (a) whenever considered necessary in the interest of safety;
- (b) during refuelling of the aircraft;
- (c) while the aircraft is on the surface unless the operator has determined procedures to mitigate the risks during ground operations;
- (d) outside designated smoking areas, in the aisle(s) and lavatory(ies);
- (e) in cargo compartments and/or other areas where cargo is carried that is not stored in flame-resistant containers or covered by flame-resistant canvas; and
- (f) in those areas of the passenger compartments where oxygen is being supplied.

NCC.OP.180 Meteorological conditions

- (a) The pilot-in-command shall only commence or continue a VFR flight if the latest available meteorological information indicates that the weather conditions along the route and at the intended destination at the estimated time of use will be at or above the applicable VFR operating minima.
- (b) The pilot-in-command shall only commence or continue an IFR flight towards the planned destination aerodrome if the latest available meteorological information indicates that, at the estimated time of arrival, the weather conditions at the destination or at least one destination alternate aerodrome are at or above the applicable aerodrome operating minima.
- (c) If a flight contains VFR and IFR segments, the meteorological information referred to in (a) and (b) shall be applicable as far as relevant.

AMC1 NCC.OP.180 Meteorological conditions**EVALUATION OF METEOROLOGICAL CONDITIONS**

Pilots should carefully evaluate the available meteorological information relevant to the proposed flight, such as applicable surface observations, winds and temperatures aloft, terminal and area forecasts, air meteorological information reports (AIRMETs), significant meteorological information (SIGMET) and pilot reports. The ultimate decision whether, when, and where to make the flight rests with the pilot-in-command. Pilots should continue to re-evaluate changing weather conditions.

GM1 NCC.OP.180 Meteorological conditions**CONTINUATION OF A FLIGHT**

In the case of in-flight re-planning, continuation of a flight refers to the point from which a revised flight plan applies.

NCC.OP.185 Ice and other contaminants — ground procedures

- (a) The operator shall establish procedures to be followed when ground de-icing and anti-icing and related inspections of the aircraft are necessary to allow the safe operation of the aircraft.
- (b) The pilot-in-command shall only commence take-off if the aircraft is clear of any deposit that might adversely affect the performance or controllability of the aircraft, except as permitted under the procedures referred to in (a) and in accordance with the AFM.

GM1 NCC.OP.185 Ice and other contaminants — ground procedures

TERMINOLOGY

Terms used in the context of de-icing/anti-icing have the meaning defined in the following subparagraphs.

- (a) 'Anti-icing fluid' includes, but is not limited to, the following:
 - (1) Type I fluid if heated to min 60 °C at the nozzle;
 - (2) mixture of water and Type I fluid if heated to min 60 °C at the nozzle;
 - (3) Type II fluid;
 - (4) mixture of water and Type II fluid;
 - (5) Type III fluid;
 - (6) mixture of water and Type III fluid;
 - (7) Type IV fluid;
 - (8) mixture of water and Type IV fluid.

On uncontaminated aircraft surfaces Type II, III and IV anti-icing fluids are normally applied unheated.

- (b) 'Clear ice': a coating of ice, generally clear and smooth, but with some air pockets. It forms on exposed objects, the temperatures of which are at, below or slightly above the freezing temperature, by the freezing of super-cooled drizzle, droplets or raindrops.
- (c) 'Conditions conducive to aircraft icing on the ground' (e.g. freezing fog, freezing precipitation, frost, rain or high humidity (on cold soaked wings), snow or mixed rain and snow).
- (d) 'Contamination', in this context, is understood as being all forms of frozen or semi-frozen moisture, such as frost, snow, slush or ice.
- (e) 'Contamination check': a check of aircraft for contamination to establish the need for de-icing.
- (f) 'De-icing fluid': such fluid includes, but is not limited to, the following:
 - (1) heated water;
 - (2) Type I fluid;
 - (3) mixture of water and Type I fluid;
 - (4) Type II fluid;
 - (5) mixture of water and Type II fluid;
 - (6) Type III fluid;
 - (7) mixture of water and Type III fluid;

- (8) Type IV fluid;
- (9) mixture of water and Type IV fluid.

De-icing fluid is normally applied heated to ensure maximum efficiency.

- (g) ‘De-icing/anti-icing’: this is the combination of de-icing and anti-icing performed in either one or two steps.
- (h) ‘Ground ice detection system (GIDS)’: system used during aircraft ground operations to inform the personnel involved in the operation and/or the flight crew about the presence of frost, ice, snow or slush on the aircraft surfaces.
- (i) ‘Lowest operational use temperature (LOUT)’: the lowest temperature at which a fluid has been tested and certified as acceptable in accordance with the appropriate aerodynamic acceptance test whilst still maintaining a freezing point buffer of not less than:
 - (1) 10 °C for a Type I de-icing/anti-icing fluid; or
 - (2) 7 °C for Type II, III or IV de-icing/anti-icing fluids.
- (j) ‘Post-treatment check’: an external check of the aircraft after de-icing and/or anti-icing treatment accomplished from suitably elevated observation points (e.g. from the de-icing/anti-icing equipment itself or other elevated equipment) to ensure that the aircraft is free from any frost, ice, snow or slush.
- (k) ‘Pre-take-off check’: an assessment normally performed by the flight crew, to validate the applied hold-over time (HoT).
- (l) ‘Pre-take-off contamination check’: a check of the treated surfaces for contamination, performed when the HoT has been exceeded or if any doubt exists regarding the continued effectiveness of the applied anti-icing treatment. It is normally accomplished externally, just before commencement of the take-off run.

ANTI-ICING CODES

- (m) The following are examples of anti-icing codes:
 - (1) ‘Type I’ at (start time) — to be used if anti-icing treatment has been performed with a Type I fluid;
 - (2) ‘Type II/100’ at (start time) — to be used if anti-icing treatment has been performed with undiluted Type II fluid;
 - (3) ‘Type II/75’ at (start time) — to be used if anti-icing treatment has been performed with a mixture of 75 % Type II fluid and 25 % water; and
 - (4) ‘Type IV/50’ at (start time) — to be used if anti-icing treatment has been performed with a mixture of 50 % Type IV fluid and 50 % water.
- (n) When a two-step de-icing/anti-icing operation has been carried out, the anti-icing code should be determined by the second step fluid. Fluid brand names may be included, if desired.

GM2 NCC.OP.185 Ice and other contaminants — ground procedures

DE-ICING/ANTI-ICING — PROCEDURES

- (a) De-icing and/or anti-icing procedures should take into account manufacturer's recommendations, including those that are type-specific, and should cover:
- (1) contamination checks, including detection of clear ice and under-wing frost; limits on the thickness/area of contamination published in the AFM or other manufacturers' documentation should be followed;
 - (2) procedures to be followed if de-icing and/or anti-icing procedures are interrupted or unsuccessful;
 - (3) post-treatment checks;
 - (4) pre-take-off checks;
 - (5) pre-take-off contamination checks;
 - (6) the recording of any incidents relating to de-icing and/or anti-icing; and
 - (7) the responsibilities of all personnel involved in de-icing and/or anti-icing.
- (b) The operator's procedures should ensure the following:
- (1) When aircraft surfaces are contaminated by ice, frost, slush or snow, they are de-iced prior to take-off, according to the prevailing conditions. Removal of contaminants may be performed with mechanical tools, fluids (including hot water), infrared heat or forced air, taking account of aircraft type-specific provisions.
 - (2) Account is taken of the wing skin temperature versus outside air temperature (OAT), as this may affect:
 - (i) the need to carry out aircraft de-icing and/or anti-icing; and/or
 - (ii) the performance of the de-icing/anti-icing fluids.
 - (3) When freezing precipitation occurs or there is a risk of freezing precipitation occurring that would contaminate the surfaces at the time of take-off, aircraft surfaces should be anti-iced. If both de-icing and anti-icing are required, the procedure may be performed in a one or two-step process, depending upon weather conditions, available equipment, available fluids and the desired hold-over time (HoT). One-step de-icing/anti-icing means that de-icing and anti-icing are carried out at the same time, using a mixture of de-icing/anti-icing fluid and water. Two-step de-icing/anti-icing means that de-icing and anti-icing are carried out in two separate steps. The aircraft is first de-iced using heated water only or a heated mixture of de-icing/anti-icing fluid and water. After completion of the de-icing operation a layer of a mixture of de-icing/anti-icing fluid and water, or of de-icing/anti-icing fluid only, is sprayed over the aircraft surfaces. The second step will be applied before the first-step fluid freezes, typically within three minutes and, if necessary, area by area.
 - (4) When an aircraft is anti-iced and a longer HoT is needed/desired, the use of a less diluted Type II or Type IV fluid should be considered.
 - (5) All restrictions relative to OAT and fluid application (including, but not necessarily limited to, temperature and pressure) published by the fluid manufacturer and/or aircraft manufacturer, are followed and procedures, limitations and recommendations to prevent the formation of fluid residues are followed.
 - (6) During conditions conducive to aircraft icing on the ground or after de-icing and/or anti-icing, an aircraft is not dispatched for departure unless it has been given a contamination

check or a post-treatment check by a trained and qualified person. This check should cover all treated surfaces of the aircraft and be performed from points offering sufficient accessibility to these parts. To ensure that there is no clear ice on suspect areas, it may be necessary to make a physical check (e.g. tactile).

- (7) The required entry is made in the technical log.
 - (8) The pilot-in-command continually monitors the environmental situation after the performed treatment. Prior to take-off he/she performs a pre-take-off check, which is an assessment of whether the applied HoT is still appropriate. This pre-take-off check includes, but is not limited to, factors such as precipitation, wind and OAT.
 - (9) If any doubt exists as to whether a deposit may adversely affect the aircraft's performance and/or controllability characteristics, the pilot-in-command should arrange for a pre-take-off contamination check to be performed in order to verify that the aircraft's surfaces are free of contamination. Special methods and/or equipment may be necessary to perform this check, especially at night time or in extremely adverse weather conditions. If this check cannot be performed just before take-off, re-treatment should be applied.
 - (10) When retreatment is necessary, any residue of the previous treatment should be removed and a completely new de-icing/anti-icing treatment should be applied.
 - (11) When a ground ice detection system (GIDS) is used to perform an aircraft surfaces check prior to and/or after a treatment, the use of GIDS by suitably trained personnel should be part of the procedure.
- (c) Special operational considerations
- (1) When using thickened de-icing/anti-icing fluids, the operator should consider a two-step de-icing/anti-icing procedure, the first step preferably with hot water and/or un-thickened fluids.
 - (2) The use of de-icing/anti-icing fluids should be in accordance with the aircraft manufacturer's documentation. This is particularly important for thickened fluids to assure sufficient flow-off during take-off.
 - (3) The operator should comply with any type-specific operational requirement(s), such as an aircraft mass decrease and/or a take-off speed increase associated with a fluid application.
 - (4) The operator should take into account any flight handling procedures (stick force, rotation speed and rate, take-off speed, aircraft attitude, etc.) laid down by the aircraft manufacturer when associated with a fluid application.
 - (5) The limitations or handling procedures resulting from (c)(3) and/or (c)(4) should be part of the flight crew pre-take-off briefing.
- (d) Communications
- (1) Before aircraft treatment. When the aircraft is to be treated with the flight crew on board, the flight and personnel involved in the operation should confirm the fluid to be used, the extent of treatment required and any aircraft type-specific procedure(s) to be used. Any other information needed to apply the HoT tables should be exchanged.
 - (2) Anti-icing code. The operator's procedures should include an anti-icing code, which indicates the treatment the aircraft has received. This code provides the flight crew with the minimum details necessary to estimate an HoT and confirms that the aircraft is free of contamination.

- (3) After treatment. Before reconfiguring or moving the aircraft, the flight crew should receive a confirmation from the personnel involved in the operation that all de-icing and/or anti-icing operations are complete and that all personnel and equipment are clear of the aircraft.
- (e) Hold-over protection
- The operator should publish in the operations manual, when required, the HoTs in the form of a table or a diagram, to account for the various types of ground icing conditions and the different types and concentrations of fluids used. However, the times of protection shown in these tables are to be used as guidelines only and are normally used in conjunction with the pre-take-off check.
- (f) Training
- The operator's initial and recurrent de-icing and/or anti-icing training programmes (including communication training) for flight crew and those of its personnel involved in the operation who are involved in de-icing and/or anti-icing should include additional training if any of the following is introduced:
- (1) a new method, procedure and/or technique;
 - (2) a new type of fluid and/or equipment; or
 - (3) a new type of aircraft.
- (g) Contracting
- When the operator contracts training on de-icing/anti-icing, the operator should ensure that the contractor complies with the operator's training/qualification procedures, together with any specific procedures in respect of:
- (1) de-icing and/or anti-icing methods and procedures;
 - (2) fluids to be used, including precautions for storage and preparation for use;
 - (3) specific aircraft requirements (e.g. no-spray areas, propeller/engine de-icing, auxiliary power unit (APU) operation etc.); and
 - (4) checking and communications procedures.
- (h) Special maintenance considerations
- (1) General
- The operator should take proper account of the possible side effects of fluid use. Such effects may include, but are not necessarily limited to, dried and/or re-hydrated residues, corrosion and the removal of lubricants.
- (2) Special considerations regarding residues of dried fluids
- The operator should establish procedures to prevent or detect and remove residues of dried fluid. If necessary, the operator should establish appropriate inspection intervals based on the recommendations of the airframe manufacturers and/or the operator's own experience:
- (i) Dried fluid residues
- Dried fluid residues could occur when surfaces have been treated and the aircraft has not subsequently been flown and has not been subject to precipitation. The fluid may then have dried on the surfaces.
- (ii) Re-hydrated fluid residues

Repetitive application of thickened de-icing/anti-icing fluids may lead to the subsequent formation/build-up of a dried residue in aerodynamically quiet areas, such as cavities and gaps. This residue may re-hydrate if exposed to high humidity conditions, precipitation, washing, etc., and increase to many times its original size/volume. This residue will freeze if exposed to conditions at or below 0 °C. This may cause moving parts, such as elevators, ailerons, and flap actuating mechanisms to stiffen or jam in-flight. Re-hydrated residues may also form on exterior surfaces, which can reduce lift, increase drag and stall speed. Re-hydrated residues may also collect inside control surface structures and cause clogging of drain holes or imbalances to flight controls. Residues may also collect in hidden areas, such as around flight control hinges, pulleys, grommets, on cables and in gaps.

- (iii) Operators are strongly recommended to obtain information about the fluid dry-out and re-hydration characteristics from the fluid manufacturers and to select products with optimised characteristics.
- (iv) Additional information should be obtained from fluid manufacturers for handling, storage, application and testing of their products.

GM3 NCC.OP.185 Ice and other contaminants — ground procedures

DE-ICING/ANTI-ICING — BACKGROUND INFORMATION

Further guidance material on this issue is given in the ICAO *Manual of Aircraft Ground De-icing/Anti-icing Operations* (Doc 9640) (hereinafter referred to as the *ICAO Manual of Aircraft Ground De-icing/Anti-icing Operations*).

(a) General

- (1) Any deposit of frost, ice, snow or slush on the external surfaces of an aircraft may drastically affect its flying qualities because of reduced aerodynamic lift, increased drag, modified stability and control characteristics. Furthermore, freezing deposits may cause moving parts, such as elevators, ailerons, flap actuating mechanism, etc., to jam and create a potentially hazardous condition. Propeller/engine/APU/systems performance may deteriorate due to the presence of frozen contaminants on blades, intakes and components. Also, engine operation may be seriously affected by the ingestion of snow or ice, thereby causing engine stall or compressor damage. In addition, ice/frost may form on certain external surfaces (e.g. wing upper and lower surfaces, etc.) due to the effects of cold fuel/structures, even in ambient temperatures well above 0 °C.
- (2) Procedures established by the operator for de-icing and/or anti-icing are intended to ensure that the aircraft is clear of contamination so that degradation of aerodynamic characteristics or mechanical interference will not occur and, following anti-icing, to maintain the airframe in that condition during the appropriate HoT.
- (3) Under certain meteorological conditions, de-icing and/or anti-icing procedures may be ineffective in providing sufficient protection for continued operations. Examples of these conditions are freezing rain, ice pellets and hail, heavy snow, high wind velocity, fast dropping OAT or any time when freezing precipitation with high water content is present. No HoT guidelines exist for these conditions.
- (4) Material for establishing operational procedures can be found, for example, in:
 - (i) ICAO Annex 3, Meteorological Service for International Air Navigation;
 - (ii) ICAO Manual of Aircraft Ground De-icing/Anti-icing Operations;

- (iii) International Organization for Standardization (ISO) 11075 Aircraft — De-icing/anti-icing fluids — ISO type I;
- (iv) ISO 11076 Aircraft — De-icing/anti-icing methods with fluids;
- (v) ISO 11077 Aerospace — Self-propelled de-icing/anti-icing vehicles — Functional requirements;
- (vi) ISO 11078 Aircraft — De-icing/anti-icing fluids — ISO types II, III and IV;
- (vii) Association of European Airlines (AEA) ‘Recommendations for de-icing/anti-icing of aircraft on the ground’;
- (viii) AEA ‘Training recommendations and background information for de-icing/anti-icing of aircraft on the ground’;
- (ix) EUROCAE ED-104A Minimum Operational Performance Specification for Ground Ice Detection Systems;
- (x) Society of Automotive Engineers (SAE) AS5681 Minimum Operational Performance Specification for Remote On-Ground Ice Detection Systems;
- (xi) SAE ARP4737 Aircraft — De-icing/anti-icing methods;
- (xii) SAE AMS1424 De-icing/anti-Icing Fluid, Aircraft, SAE Type I;
- (xiii) SAE AMS1428 Fluid, Aircraft De-icing/anti-icing, Non-Newtonian, (Pseudoplastic), SAE Types II, III, and IV;
- (xiv) SAE ARP1971 Aircraft De-icing Vehicle — Self-Propelled, Large and Small Capacity;
- (xv) SAE ARP5149 Training Programme Guidelines for De-icing/anti-icing of Aircraft on Ground; and
- (xvi) SAE ARP5646 Quality Program Guidelines for De-icing/anti-icing of Aircraft on the Ground.

(b) Fluids

- (1) Type I fluid: Due to its properties, Type I fluid forms a thin, liquid-wetting film on surfaces to which it is applied which, under certain weather conditions, gives a very limited HoT. With this type of fluid, increasing the concentration of fluid in the fluid/water mix does not provide any extension in HoT.
- (2) Type II and Type IV fluids contain thickeners that enable the fluid to form a thicker liquid-wetting film on surfaces to which it is applied. Generally, this fluid provides a longer HoT than Type I fluids in similar conditions. With this type of fluid, the HoT can be extended by increasing the ratio of fluid in the fluid/water mix.
- (3) Type III fluid is a thickened fluid especially intended for use on aircraft with low rotation speeds.
- (4) Fluids used for de-icing and/or anti-icing should be acceptable to the operator and the aircraft manufacturer. These fluids normally conform to specifications such as SAE AMS1424, SAE AMS1428 or equivalent. Use of non-conforming fluids is not recommended due to their characteristics being unknown. The anti-icing and aerodynamic properties of thickened fluids may be seriously degraded by, for example, inappropriate storage, treatment, application, application equipment and age.

(c) Hold-over protection

- (1) Hold-over protection is achieved by a layer of anti-icing fluid remaining on and protecting aircraft surfaces for a period of time. With a one-step de-icing/anti-icing procedure, the HoT begins at the commencement of de-icing/anti-icing. With a two-step procedure, the HoT begins at the commencement of the second (anti-icing) step. The hold-over protection runs out:
 - (i) at the commencement of the take-off roll (due to aerodynamic shedding of fluid); or
 - (ii) when frozen deposits start to form or accumulate on treated aircraft surfaces, thereby indicating the loss of effectiveness of the fluid.
- (2) The duration of hold-over protection may vary depending on the influence of factors other than those specified in the HoT tables. Guidance should be provided by the operator to take account of such factors, which may include:
 - (i) atmospheric conditions, e.g. exact type and rate of precipitation, wind direction and velocity, relative humidity and solar radiation; and
 - (ii) the aircraft and its surroundings, such as aircraft component inclination angle, contour and surface roughness, surface temperature, operation in close proximity to other aircraft (jet or propeller blast) and ground equipment and structures.
- (3) HoTs are not meant to imply that flight is safe in the prevailing conditions if the specified HoT has not been exceeded. Certain meteorological conditions, such as freezing drizzle or freezing rain, may be beyond the certification envelope of the aircraft.
- (4) References to usable HoT tables may be found in the AEA 'Recommendations for de-icing/anti-icing of aircraft on the ground'.

NCC.OP.190 Ice and other contaminants — flight procedures

- (a) The operator shall establish procedures for flights in expected or actual icing conditions.
- (b) The pilot-in-command shall only commence a flight or intentionally fly into expected or actual icing conditions if the aircraft is certified and equipped to cope with such conditions as referred to in 2.a.5 of Annex IV to Regulation (EC) No 216/2008.
- (c) If icing exceeds the intensity of icing for which the aircraft is certified or if an aircraft not certified for flight in known icing conditions encounters icing, the pilot-in-command shall exit the icing conditions without delay, by a change of level and/or route, and if necessary by declaring an emergency to ATC.

AMC1 NCC.OP.190 Ice and other contaminants — flight procedures

FLIGHT IN EXPECTED OR ACTUAL ICING CONDITIONS

- (a) The procedures to be established by the operator should take account of the design, the equipment, the configuration of the aircraft and the necessary training. For these reasons, different aircraft types operated by the same company may require the development of different procedures. In every case, the relevant limitations are those that are defined in the AFM and other documents produced by the manufacturer.
- (b) The operator should ensure that the procedures take account of the following:
 - (1) the equipment and instruments that should be serviceable for flight in icing conditions;
 - (2) the limitations on flight in icing conditions for each phase of flight. These limitations may be imposed by the aircraft's de-icing or anti-icing equipment or the necessary performance corrections that have to be made;
 - (3) the criteria the flight crew should use to assess the effect of icing on the performance and/or controllability of the aircraft;
 - (4) the means by which the flight crew detects, by visual cues or the use of the aircraft's ice detection system, that the flight is entering icing conditions; and
 - (5) the action to be taken by the flight crew in a deteriorating situation (which may develop rapidly) resulting in an adverse effect on the performance and/or controllability of the aircraft, due to:
 - (i) the failure of the aircraft's anti-icing or de-icing equipment to control a build-up of ice; and/or
 - (ii) ice build-up on unprotected areas.
- (c) Training for dispatch and flight in expected or actual icing conditions. The content of the operations manual should reflect the training, both conversion and recurrent, that flight crew, cabin crew and all other relevant operational personnel require in order to comply with the procedures for dispatch and flight in icing conditions:
 - (1) For the flight crew, the training should include:
 - (i) instruction on how to recognise, from weather reports or forecasts that are available before flight commences or during flight, the risks of encountering icing conditions along the planned route and on how to modify, as necessary, the departure and in-flight routes or profiles;
 - (ii) instruction on the operational and performance limitations or margins;

- (iii) the use of in-flight ice detection, anti-icing and de-icing systems in both normal and abnormal operation; and
 - (iv) instruction on the differing intensities and forms of ice accretion and the consequent action which should be taken.
- (2) For the cabin crew, the training should include:
- (i) awareness of the conditions likely to produce surface contamination; and
 - (ii) the need to inform the flight crew of significant ice accretion.

NCC.OP.195 Take-off conditions

Before commencing take-off, the pilot-in-command shall be satisfied that:

- (a) according to the information available, the weather at the aerodrome or operating site and the condition of the runway or FATO intended to be used would not prevent a safe take-off and departure; and
- (b) applicable aerodrome operating minima will be complied with.

NCC.OP.200 Simulated situations in flight

- (a) The pilot-in-command shall, when carrying passengers or cargo, not simulate:
 - (1) situations that require the application of abnormal or emergency procedures; or
 - (2) flight in instrument meteorological conditions (IMC).
- (b) Notwithstanding (a), when training flights are conducted by an approved training organisation, such situations may be simulated with student pilots on-board.

NCC.OP.205 In-flight fuel management

- (a) The operator shall establish a procedure to ensure that in-flight fuel checks and fuel management are performed.
- (b) The pilot-in-command shall check at regular intervals that the amount of usable fuel remaining in flight is not less than the fuel required to proceed to a weather-permissible aerodrome or operating site and the planned reserve fuel as required by NCC.OP.130 or NCC.OP.131.

NCC.OP.210 Use of supplemental oxygen

The pilot-in-command shall ensure that he/she and flight crew members engaged in performing duties essential to the safe operation of an aircraft in flight use supplemental oxygen continuously whenever the cabin altitude exceeds 10 000 ft for a period of more than 30 minutes and whenever the cabin altitude exceeds 13 000 ft.

NCC.OP.215 Ground proximity detection

When undue proximity to the ground is detected by a flight crew member or by a ground proximity warning system, the pilot flying shall take corrective action immediately in order to establish safe flight conditions.

GM1 NCC.OP.215 Ground proximity detection

GUIDANCE MATERIAL FOR TERRAIN AWARENESS WARNING SYSTEM (TAWS) FLIGHT CREW TRAINING PROGRAMMES

- (a) Introduction
 - (1) This GM contains performance-based training objectives for TAWS flight crew training.
 - (2) The training objectives cover five areas: theory of operation; pre-flight operations; general in-flight operations; response to TAWS cautions; response to TAWS warnings.
 - (3) The term 'TAWS' in this GM means a ground proximity warning system (GPWS) enhanced by a forward-looking terrain avoidance function. Alerts include both cautions and warnings.

- (4) The content of this GM is intended to assist operators who are producing training programmes. The information it contains has not been tailored to any specific aircraft or TAWS equipment, but highlights features that are typically available where such systems are installed. It is the responsibility of the individual operator to determine the applicability of the content of this Guidance Material to each aircraft and TAWS equipment installed and their operation. Operators should refer to the AFM and/or aircraft/flight crew operating manual (A/FCOM), or similar documents, for information applicable to specific configurations. If there should be any conflict between the content of this Guidance Material and that published in the other documents described above, then the information contained in the AFM or A/FCOM will take precedence.
- (b) Scope
- (1) The scope of this GM is designed to identify training objectives in the areas of: academic training; manoeuvre training; initial evaluation; recurrent qualification. Under each of these four areas, the training material has been separated into those items that are considered essential training items and those that are considered to be desirable. In each area, objectives and acceptable performance criteria are defined.
- (2) No attempt is made to define how the training programme should be implemented. Instead, objectives are established to define the knowledge that a pilot operating a TAWS is expected to possess and the performance expected from a pilot who has completed TAWS training. However, the guidelines do indicate those areas in which the pilot receiving the training should demonstrate his/her understanding, or performance, using a real time interactive training device, i.e. a flight simulator. Where appropriate, notes are included within the performance criteria that amplify or clarify the material addressed by the training objective.
- (c) Performance-based training objectives
- (1) TAWS academic training
- (i) This training is typically conducted in a classroom environment. The knowledge demonstrations specified in this section may be completed through the successful completion of written tests or by providing correct responses to non-real-time computer-based training (CBT) questions.
- (ii) Theory of operation. The pilot should demonstrate an understanding of TAWS operation and the criteria used for issuing cautions and warnings. This training should address system operation. Objective: to demonstrate knowledge of how a TAWS functions. Criteria: the pilot should demonstrate an understanding of the following functions:
- (A) Surveillance
- (a) The GPWS computer processes data supplied from an air data computer, a radio altimeter, an instrument landing system (ILS)/microwave landing system (MLS)/multi-mode (MM) receiver, a roll attitude sensor, and actual position of the surfaces and of the landing gear.
- (b) The forward-looking terrain avoidance function utilises an accurate source of known aircraft position, such as that which may be provided by a flight management system (FMS) or global positioning system (GPS), or an electronic terrain database. The source and scope of the terrain, obstacle and airport data, and features such as the terrain

- clearance floor, the runway picker, and geometric altitude (where provided), should all be described.
- (c) Displays required to deliver TAWS outputs include a loudspeaker for voice announcements, visual alerts (typically amber and red lights) and a terrain awareness display (that may be combined with other displays). In addition, means should be provided for indicating the status of the TAWS and any partial or total failures that may occur.
- (B) Terrain avoidance. Outputs from the TAWS computer provide visual and audio synthetic voice cautions and warnings to alert the flight crew about potential conflicts with terrain and obstacles.
- (C) Alert thresholds. Objective: to demonstrate knowledge of the criteria for issuing cautions and warnings. Criteria: the pilot should be able to demonstrate an understanding of the methodology used by a TAWS to issue cautions and alerts and the general criteria for the issuance of these alerts, including:
- (a) basic GPWS alerting modes specified in the ICAO standard:
 - Mode 1: excessive sink rate;
 - Mode 2: excessive terrain closure rate;
 - Mode 3: descent after take-off or missed approach;
 - Mode 4: unsafe proximity to terrain; and
 - Mode 5: descent below ILS glide slope (caution only);
 - (b) an additional, optional alert mode:
 - Mode 6: radio altitude call-out (information only); and
 - (c) TAWS cautions and warnings that alert the flight crew to obstacles and terrain ahead of the aircraft in line with or adjacent to its projected flight path (forward-looking terrain avoidance (FLTA) and premature descent alert (PDA) functions).
- (D) TAWS limitations. Objective: to verify that the pilot is aware of the limitations of TAWS. Criteria: the pilot should demonstrate knowledge and an understanding of TAWS limitations identified by the manufacturer for the equipment model installed, such as:
- (a) navigation should not be predicated on the use of the terrain display;
 - (b) unless geometric altitude data is provided, use of predictive TAWS functions is prohibited when altimeter subscale settings display 'QFE' (atmospheric pressure at aerodrome elevation/runway threshold);
 - (c) nuisance alerts can be issued if the aerodrome of intended landing is not included in the TAWS airport database;
 - (d) in cold weather operations, corrective procedures should be implemented by the pilot unless the TAWS has in-built compensation, such as geometric altitude data;
 - (e) loss of input data to the TAWS computer could result in partial or total loss of functionality. Where means exist to inform the flight crew that

- functionality has been degraded, this should be known and the consequences understood;
- (f) radio signals not associated with the intended flight profile (e.g. ILS glide path transmissions from an adjacent runway) may cause false alerts;
 - (g) inaccurate or low accuracy aircraft position data could lead to false or non-annunciation of terrain or obstacles ahead of the aircraft; and
 - (h) minimum equipment list (MEL) restrictions should be applied in the event of the TAWS becoming partially or completely unserviceable. (It should be noted that basic GPWS has no forward-looking capability.)
- (E) TAWS inhibits. Objective: to verify that the pilot is aware of the conditions under which certain functions of a TAWS are inhibited. Criteria: the pilot should demonstrate knowledge and an understanding of the various TAWS inhibits, including the following means of:
- (a) silencing voice alerts;
 - (b) inhibiting ILS glide path signals (as may be required when executing an ILS back beam approach);
 - (c) inhibiting flap position sensors (as may be required when executing an approach with the flaps not in a normal position for landing);
 - (d) inhibiting the FLTA and PDA functions; and
 - (e) selecting or deselecting the display of terrain information, together with appropriate annunciation of the status of each selection.
- (2) Operating procedures. The pilot should demonstrate the knowledge required to operate TAWS avionics and to interpret the information presented by a TAWS. This training should address the following topics:
- (i) Use of controls. Objective: to verify that the pilot can properly operate all TAWS controls and inhibits. Criteria: the pilot should demonstrate the proper use of controls, including the following means by which:
 - (A) before flight, any equipment self-test functions can be initiated;
 - (B) TAWS information can be selected for display; and
 - (C) all TAWS inhibits can be operated and what the consequent annunciations mean with regard to loss of functionality.
 - (ii) Display interpretation. Objective: to verify that the pilot understands the meaning of all information that can be annunciated or displayed by a TAWS. Criteria: the pilot should demonstrate the ability to properly interpret information annunciated or displayed by a TAWS, including the following:
 - (A) knowledge of all visual and aural indications that may be seen or heard;
 - (B) response required on receipt of a caution;
 - (C) response required on receipt of a warning; and
 - (D) response required on receipt of a notification that partial or total failure of the TAWS has occurred (including annunciation that the present aircraft position is of low accuracy).

- (iii) Use of basic GPWS or use of the FLTA function only. Objective: to verify that the pilot understands what functionality will remain following loss of the GPWS or of the FLTA function. Criteria: the pilot should demonstrate knowledge of how to recognise the following:
 - (A) un-commanded loss of the GPWS function, or how to isolate this function and how to recognise the level of the remaining controlled flight into terrain (CFIT) protection (essentially, this is the FLTA function); and
 - (B) un-commanded loss of the FLTA function, or how to isolate this function and how to recognise the level of the remaining CFIT protection (essentially, this is the basic GPWS).
 - (iv) Crew coordination. Objective: to verify that the pilot adequately briefs other flight crew members on how TAWS alerts will be handled. Criteria: the pilot should demonstrate that the pre-flight briefing addresses procedures that will be used in preparation for responding to TAWS cautions and warnings, including the following:
 - (A) the action to be taken, and by whom, in the event that a TAWS caution and/or warning is issued; and
 - (B) how multi-function displays will be used to depict TAWS information at take-off, in the cruise and for the descent, approach, landing (and any missed approach). This will be in accordance with procedures specified by the operator, who will recognise that it may be more desirable that other data is displayed at certain phases of flight and that the terrain display has an automatic 'pop-up' mode in the event that an alert is issued.
 - (v) Reporting rules. Objective: to verify that the pilot is aware of the rules for reporting alerts to the controller and other authorities. Criteria: the pilot should demonstrate knowledge of the following:
 - (A) when, following recovery from a TAWS alert or caution, a transmission of information should be made to the appropriate ATC unit; and
 - (B) the type of written report that is required, how it is to be compiled and whether any cross-reference should be made in the aircraft technical log and/or voyage report (in accordance with procedures specified by the operator), following a flight in which the aircraft flight path has been modified in response to a TAWS alert, or if any part of the equipment appears not to have functioned correctly.
 - (vi) Alert thresholds. Objective: to demonstrate knowledge of the criteria for issuing cautions and warnings. Criteria: the pilot should be able to demonstrate an understanding of the methodology used by a TAWS to issue cautions and warnings and the general criteria for the issuance of these alerts, including awareness of the following:
 - (A) modes associated with basic GPWS, including the input data associated with each; and
 - (B) visual and aural annunciations that can be issued by TAWS and how to identify which are cautions and which are warnings.
- (3) TAWS manoeuvre training. The pilot should demonstrate the knowledge required to respond correctly to TAWS cautions and warnings. This training should address the following topics:

- (i) Response to cautions:
 - (A) Objective: to verify that the pilot properly interprets and responds to cautions. Criteria: the pilot should demonstrate an understanding of the need, without delay:
 - (a) to initiate action required to correct the condition that has caused the TAWS to issue the caution and to be prepared to respond to a warning, if this should follow; and
 - (b) if a warning does not follow the caution, to notify the controller of the new position, heading and/or altitude/flight level of the aircraft, and what the pilot-in-command intends to do next.
 - (B) The correct response to a caution might require the pilot to:
 - (a) reduce a rate of descent and/or to initiate a climb;
 - (b) regain an ILS glide path from below, or to inhibit a glide path signal if an ILS is not being flown;
 - (c) select more flap, or to inhibit a flap sensor if the landing is being conducted with the intent that the normal flap setting will not be used;
 - (d) select gear down; and/or
 - (e) initiate a turn away from the terrain or obstacle ahead and towards an area free of such obstructions if a forward-looking terrain display indicates that this would be a good solution and the entire manoeuvre can be carried out in clear visual conditions.
- (ii) Response to warnings. Objective: to verify that the pilot properly interprets and responds to warnings. Criteria: the pilot should demonstrate an understanding of the following:
 - (A) The need, without delay, to initiate a climb in the manner specified by the operator.
 - (B) The need, without delay, to maintain the climb until visual verification can be made that the aircraft will clear the terrain or obstacle ahead or until above the appropriate sector safe altitude (if certain about the location of the aircraft with respect to terrain) even if the TAWS warning stops. If, subsequently, the aircraft climbs up through the sector safe altitude, but the visibility does not allow the flight crew to confirm that the terrain hazard has ended, checks should be made to verify the location of the aircraft and to confirm that the altimeter subscale settings are correct.
 - (C) When workload permits, that the flight crew should notify the air traffic controller of the new position and altitude/flight level and what the pilot-in-command intends to do next.
 - (D) That the manner in which the climb is made should reflect the type of aircraft and the method specified by the aircraft manufacturer (which should be reflected in the operations manual) for performing the escape manoeuvre. Essential aspects will include the need for an increase in pitch attitude, selection of maximum thrust, confirmation that external sources of drag (e.g. spoilers/speed brakes) are retracted and respect of the stick shaker or other indication of eroded stall margin.

- (E) That TAWS warnings should never be ignored. However, the pilot's response may be limited to that which is appropriate for a caution, only if:
 - (a) the aircraft is being operated by day in clear, visual conditions; and
 - (b) it is immediately clear to the pilot that the aircraft is in no danger in respect of its configuration, proximity to terrain or current flight path.
- (4) TAWS initial evaluation:
 - (i) The flight crew member's understanding of the academic training items should be assessed by means of a written test.
 - (ii) The flight crew member's understanding of the manoeuvre training items should be assessed in a flight simulation training device (FSTD) equipped with TAWS visual and aural displays and inhibit selectors similar in appearance and operation to those in the aircraft that the pilot will fly. The results should be assessed by a flight simulation training instructor, synthetic flight examiner, type rating instructor or type rating examiner.
 - (iii) The range of scenarios should be designed to give confidence that proper and timely responses to TAWS cautions and warnings will result in the aircraft avoiding a CFIT accident. To achieve this objective, the pilot should demonstrate taking the correct action to prevent a caution developing into a warning and, separately, the escape manoeuvre needed in response to a warning. These demonstrations should take place when the external visibility is zero, though there is much to be learnt if, initially, the training is given in 'mountainous' or 'hilly' terrain with clear visibility. This training should comprise a sequence of scenarios, rather than be included in line orientated flight training (LOFT).
 - (iv) A record should be made, after the pilot has demonstrated competence, of the scenarios that were practised.
- (5) TAWS recurrent training:
 - (i) TAWS recurrent training ensures that pilots maintain the appropriate TAWS knowledge and skills. In particular, it reminds pilots of the need to act promptly in response to cautions and warnings and of the unusual attitude associated with flying the escape manoeuvre.
 - (ii) An essential item of recurrent training is the discussion of any significant issues and operational concerns that have been identified by the operator. Recurrent training should also address changes to TAWS logic, parameters or procedures and to any unique TAWS characteristics of which pilots should be aware.
- (6) Reporting procedures:
 - (i) Verbal reports. Verbal reports should be made promptly to the appropriate ATC unit:
 - (A) whenever any manoeuvre has caused the aircraft to deviate from an air traffic clearance;
 - (B) when, following a manoeuvre that has caused the aircraft to deviate from an air traffic clearance, the aircraft has returned to a flight path that complies with the clearance; and/or
 - (C) when an air traffic control unit issues instructions that, if followed, would cause the pilot to manoeuvre the aircraft towards terrain or obstacle or it

would appear from the display that a potential CFIT occurrence is likely to result.

- (ii) Written reports. Written reports should be submitted in accordance with the operator's occurrence reporting scheme and they also should be recorded in the aircraft technical log:
 - (A) whenever the aircraft flight path has been modified in response to a TAWS alert (false, nuisance or genuine);
 - (B) whenever a TAWS alert has been issued and is believed to have been false; and/or
 - (C) if it is believed that a TAWS alert should have been issued, but was not.
- (iii) Within this GM, and with regard to reports:
 - (A) the term 'false' means that the TAWS issued an alert that could not possibly be justified by the position of the aircraft in respect to terrain and it is probable that a fault or failure in the system (equipment and/or input data) was the cause;
 - (B) the term 'nuisance' means that the TAWS issued an alert that was appropriate, but was not needed because the flight crew could determine by independent means that the flight path was, at that time, safe;
 - (C) the term 'genuine' means that the TAWS issued an alert that was both appropriate and necessary;
 - (D) the report terms described in (c)(6)(iii) are only meant to be assessed after the occurrence is over, to facilitate subsequent analysis, the adequacy of the equipment and the programmes it contains. The intention is not for the flight crew to attempt to classify an alert into any of these three categories when visual and/or aural cautions or warnings are annunciated.

NCC.OP.220 Airborne collision avoidance system (ACAS)

The operator shall establish operational procedures and training programs when ACAS is installed and serviceable so that the flight crew is appropriately trained in the avoidance of collisions and competent in the use of ACAS II equipment.

GM1 NCC.OP.220 Airborne collision avoidance system (ACAS)

GENERAL

- (a) The ACAS operational procedures and training programmes established by the operator should take into account this Guidance Material. It incorporates advice contained in:
 - (1) ICAO Annex 10, Volume IV;
 - (2) ICAO PANS-OPS, Volume 1;
 - (3) ICAO PANS-ATM; and
 - (4) ICAO guidance material 'ACAS Performance-Based Training Objectives' (published under Attachment E of State Letter AN 7/1.3.7.2-97/77).
- (b) Additional guidance material on ACAS may be referred to, including information available from such sources as EUROCONTROL.

ACAS FLIGHT CREW TRAINING

- (c) During the implementation of ACAS, several operational issues were identified that had been attributed to deficiencies in flight crew training programmes. As a result, the issue of flight crew training has been discussed within the ICAO, which has developed guidelines for operators to use when designing training programmes.
- (d) This Guidance Material contains performance-based training objectives for ACAS II flight crew training. Information contained here related to traffic advisories (TAs) is also applicable to ACAS I and ACAS II users. The training objectives cover five areas: theory of operation; pre-flight operations; general in-flight operations; response to TAs; and response to resolution advisories (RAs).
- (e) The information provided is valid for version 7 and 7.1 (ACAS II). Where differences arise, these are identified.
- (f) The performance-based training objectives are further divided into the areas of: academic training; manoeuvre training; initial evaluation and recurrent qualification. Under each of these four areas, the training material has been separated into those items which are considered essential training items and those which are considered desirable. In each area, objectives and acceptable performance criteria are defined.
- (g) ACAS academic training
 - (1) This training is typically conducted in a classroom environment. The knowledge demonstrations specified in this section may be completed through the successful completion of written tests or through providing correct responses to non-real-time computer-based training (CBT) questions.
 - (2) Essential items
 - (i) Theory of operation. The flight crew member should demonstrate an understanding of ACAS II operation and the criteria used for issuing TAs and RAs. This training should address the following topics:

(A) System operation

Objective: to demonstrate knowledge of how ACAS functions.

Criteria: the flight crew member should demonstrate an understanding of the following functions:

(a) Surveillance

- (1) ACAS interrogates other transponder-equipped aircraft within a nominal range of 14 NM.
- (2) ACAS surveillance range can be reduced in geographic areas with a large number of ground interrogators and/or ACAS II-equipped aircraft.
- (3) If the operator's ACAS implementation provides for the use of the Mode S extended squitter, the normal surveillance range may be increased beyond the nominal 14 NM. However, this information is not used for collision avoidance purposes.

(b) Collision avoidance

- (1) TAs can be issued against any transponder-equipped aircraft that responds to the ICAO Mode C interrogations, even if the aircraft does not have altitude reporting capability.
- (2) RAs can be issued only against aircraft that are reporting altitude and in the vertical plane only.
- (3) RAs issued against an ACAS-equipped intruder are coordinated to ensure complementary RAs are issued.
- (4) Failure to respond to an RA deprives own aircraft of the collision protection provided by own ACAS.
- (5) Additionally, in ACAS-ACAS encounters, failure to respond to an RA also restricts the choices available to the other aircraft's ACAS and thus renders the other aircraft's ACAS less effective than if own aircraft were not ACAS equipped.

(B) Advisory thresholds

Objective: to demonstrate knowledge of the criteria for issuing TAs and RAs.

Criteria: the flight crew member should demonstrate an understanding of the methodology used by ACAS to issue TAs and RAs and the general criteria for the issuance of these advisories, including the following:

- (a) ACAS advisories are based on time to closest point of approach (CPA) rather than distance. The time should be short and vertical separation should be small, or projected to be small, before an advisory can be issued. The separation standards provided by ATS are different from the miss distances against which ACAS issues alerts.
- (b) Thresholds for issuing a TA or an RA vary with altitude. The thresholds are larger at higher altitudes.
- (c) A TA occurs from 15 to 48 seconds and an RA from 15 to 35 seconds before the projected CPA.

- (d) RAs are chosen to provide the desired vertical miss distance at CPA. As a result, RAs can instruct a climb or descent through the intruder aircraft's altitude.

(C) ACAS limitations

Objective: to verify that the flight crew member is aware of the limitations of ACAS.

Criteria: the flight crew member should demonstrate knowledge and understanding of ACAS limitations, including the following:

- (a) ACAS will neither track nor display non-transponder-equipped aircraft, nor aircraft not responding to ACAS Mode C interrogations.
- (b) ACAS will automatically fail if the input from the aircraft's barometric altimeter, radio altimeter or transponder is lost.
 - (1) In some installations, the loss of information from other on board systems such as an inertial reference system (IRS) or attitude heading reference system (AHRS) may result in an ACAS failure. Individual operators should ensure that their flight crews are aware of the types of failure which will result in an ACAS failure.
 - (2) ACAS may react in an improper manner when false altitude information is provided to own ACAS or transmitted by another aircraft. Individual operators should ensure that their flight crew are aware of the types of unsafe conditions which can arise. Flight crew members should ensure that when they are advised, if their own aircraft is transmitting false altitude reports, an alternative altitude reporting source is selected, or altitude reporting is switched off.
- (c) Some aeroplanes within 380 ft above ground level (AGL) (nominal value) are deemed to be 'on ground' and will not be displayed. If ACAS is able to determine an aircraft below this altitude is airborne, it will be displayed.
- (d) ACAS may not display all proximate transponder-equipped aircraft in areas of high density traffic.
- (e) The bearing displayed by ACAS is not sufficiently accurate to support the initiation of horizontal manoeuvres based solely on the traffic display.
- (f) ACAS will neither track nor display intruders with a vertical speed in excess of 10 000 ft/min. In addition, the design implementation may result in some short-term errors in the tracked vertical speed of an intruder during periods of high vertical acceleration by the intruder.
- (g) Ground proximity warning systems/ground collision avoidance systems (GPWSs/GCASs) warnings and wind shear warnings take precedence over ACAS advisories. When either a GPWS/GCAS or wind shear warning is active, ACAS aural annunciations will be inhibited and ACAS will automatically switch to the 'TA only' mode of operation.

(D) ACAS inhibits

Objective: to verify that the flight crew member is aware of the conditions under which certain functions of ACAS are inhibited.

Criteria: the flight crew member should demonstrate knowledge and understanding of the various ACAS inhibits, including the following:

- (a) 'Increase Descent' RAs are inhibited below 1 450 ft AGL.
- (b) 'Descend' RAs are inhibited below 1 100 ft AGL.
- (c) All RAs are inhibited below 1 000 ft AGL.
- (d) All TA aural annunciations are inhibited below 500 ft AGL.
- (e) Altitude and configuration under which 'Climb' and 'Increase Climb' RAs are inhibited. ACAS can still issue 'Climb' and 'Increase Climb' RAs when operating at the aeroplane's certified ceiling. (In some aircraft types, 'Climb' or 'Increase Climb' RAs are never inhibited.)

(ii) Operating procedures

The flight crew member should demonstrate the knowledge required to operate the ACAS avionics and interpret the information presented by ACAS. This training should address the following:

(A) Use of controls

Objective: to verify that the pilot can properly operate all ACAS and display controls.

Criteria: demonstrate the proper use of controls, including the following:

- (a) Aircraft configuration required to initiate a self-test.
- (b) Steps required to initiate a self-test.
- (c) Recognising when the self-test was successful and when it was unsuccessful. When the self-test is unsuccessful, recognising the reason for the failure and, if possible, correcting the problem.
- (d) Recommended usage of range selection. Low ranges are used in the terminal area and the higher display ranges are used in the en-route environment and in the transition between the terminal and en-route environment.
- (e) Recognising that the configuration of the display does not affect the ACAS surveillance volume.
- (f) Selection of lower ranges when an advisory is issued, to increase display resolution.
- (g) Proper configuration to display the appropriate ACAS information without eliminating the display of other needed information.
- (h) If available, recommended usage of the above/below mode selector. The above mode should be used during climb and the below mode should be used during descent.
- (i) If available, proper selection of the display of absolute or relative altitude and the limitations of using this display if a barometric correction is not provided to ACAS.

(B) Display interpretation

Objective: to verify that the flight crew member understands the meaning of all information that can be displayed by ACAS. The wide variety of display

implementations require the tailoring of some criteria. When the training programme is developed, these criteria should be expanded to cover details for the operator's specific display implementation.

Criteria: the flight crew member should demonstrate the ability to properly interpret information displayed by ACAS, including the following:

- (a) Other traffic, i.e. traffic within the selected display range that is not proximate traffic, or causing a TA or RA to be issued.
- (b) Proximate traffic, i.e. traffic that is within 6 NM and $\pm 1\,200$ ft.
- (c) Non-altitude reporting traffic.
- (d) No bearing TAs and RAs.
- (e) Off-scale TAs and RAs: the selected range should be changed to ensure that all available information on the intruder is displayed.
- (f) TAs: the minimum available display range that allows the traffic to be displayed should be selected, to provide the maximum display resolution.
- (g) RAs (traffic display): the minimum available display range of the traffic display that allows the traffic to be displayed should be selected, to provide the maximum display resolution.
- (h) RAs (RA display): flight crew members should demonstrate knowledge of the meaning of the red and green areas or the meaning of pitch or flight path angle cues displayed on the RA display. Flight crew members should also demonstrate an understanding of the RA display limitations, i.e. if a vertical speed tape is used and the range of the tape is less than 2 500 ft/min, an increase rate RA cannot be properly displayed.
- (i) If appropriate, awareness that navigation displays oriented on 'Track-Up' may require a flight crew member to make a mental adjustment for drift angle when assessing the bearing of proximate traffic.

(C) Use of the TA only mode

Objective: to verify that a flight crew member understands the appropriate times to select the TA only mode of operation and the limitations associated with using this mode.

Criteria: the flight crew member should demonstrate the following:

- (a) Knowledge of the operator's guidance for the use of TA only.
- (b) Reasons for using this mode. If TA only is not selected when an airport is conducting simultaneous operations from parallel runways separated by less than 1 200 ft, and to some intersecting runways, RAs can be expected. If, for any reason, TA only is not selected and an RA is received in these situations, the response should comply with the operator's approved procedures.
- (c) All TA aural annunciations are inhibited below 500 ft AGL. As a result, TAs issued below 500 ft AGL may not be noticed unless the TA display is included in the routine instrument scan.

(D) Crew coordination

Objective: to verify that the flight crew member understands how ACAS advisories will be handled.

Criteria: the flight crew member should demonstrate knowledge of the crew procedures that should be used when responding to TAs and RAs, including the following:

- (a) task sharing between the pilot flying and the pilot monitoring;
- (b) expected call-outs; and
- (c) communications with ATC.

(E) Phraseology rules

Objective: to verify that the flight crew member is aware of the rules for reporting RAs to the controller.

Criteria: the flight crew member should demonstrate the following:

- (a) the use of the phraseology contained in ICAO PANS-OPS;
- (b) an understanding of the procedures contained in ICAO PANS-ATM and ICAO Annex 2; and
- (c) the understanding that verbal reports should be made promptly to the appropriate ATC unit:
 - (1) whenever any manoeuvre has caused the aeroplane to deviate from an air traffic clearance;
 - (2) when, subsequent to a manoeuvre that has caused the aeroplane to deviate from an air traffic clearance, the aeroplane has returned to a flight path that complies with the clearance; and/or
 - (3) when air traffic issue instructions that, if followed, would cause the crew to manoeuvre the aircraft contrary to an RA with which they are complying.

(F) Reporting rules

Objective: to verify that the flight crew member is aware of the rules for reporting RAs to the operator.

Criteria: the flight crew member should demonstrate knowledge of where information can be obtained regarding the need for making written reports to various States when an RA is issued. Various States have different reporting rules and the material available to the flight crew member should be tailored to the operator's operating environment. This responsibility is satisfied by the flight crew member reporting to the operator according to the applicable reporting rules.

(3) Non-essential items: advisory thresholds

Objective: to demonstrate knowledge of the criteria for issuing TAs and RAs.

Criteria: the flight crew member should demonstrate an understanding of the methodology used by ACAS to issue TAs and RAs and the general criteria for the issuance of these advisories, including the following:

- (i) The minimum and maximum altitudes below/above which TAs will not be issued.

- (ii) When the vertical separation at CPA is projected to be less than the ACAS-desired separation, a corrective RA that requires a change to the existing vertical speed will be issued. This separation varies from 300 ft at low altitude to a maximum of 700 ft at high altitude.
 - (iii) When the vertical separation at CPA is projected to be just outside the ACAS-desired separation, a preventive RA that does not require a change to the existing vertical speed will be issued. This separation varies from 600 to 800 ft.
 - (iv) RA fixed range thresholds vary between 0.2 and 1.1 NM.
- (h) ACAS manoeuvre training
- (1) Demonstration of the flight crew member's ability to use ACAS displayed information to properly respond to TAs and RAs should be carried out in a full flight simulator equipped with an ACAS display and controls similar in appearance and operation to those in the aircraft. If a full flight simulator is utilised, crew resource management (CRM) should be practised during this training.
 - (2) Alternatively, the required demonstrations can be carried out by means of an interactive CBT with an ACAS display and controls similar in appearance and operation to those in the aircraft. This interactive CBT should depict scenarios in which real-time responses should be made. The flight crew member should be informed whether or not the responses made were correct. If the response was incorrect or inappropriate, the CBT should show what the correct response should be.
 - (3) The scenarios included in the manoeuvre training should include: corrective RAs; initial preventive RAs; maintain rate RAs; altitude crossing RAs; increase rate RAs; RA reversals; weakening RAs; and multi-aircraft encounters. The consequences of failure to respond correctly should be demonstrated by reference to actual incidents such as those publicised in EUROCONTROL ACAS II Bulletins (available on the EUROCONTROL website).
- (i) TA responses
- Objective: to verify that the pilot properly interprets and responds to TAs.
- Criteria: the pilot should demonstrate the following:
- (A) Proper division of responsibilities between the pilot flying and the pilot monitoring. The pilot flying should fly the aircraft using any type-specific procedures and be prepared to respond to any RA that might follow. For aircraft without an RA pitch display, the pilot flying should consider the likely magnitude of an appropriate pitch change. The pilot monitoring should provide updates on the traffic location shown on the ACAS display, using this information to help visually acquire the intruder.
 - (B) Proper interpretation of the displayed information. Flight crew members should confirm that the aircraft they have visually acquired is that which has caused the TA to be issued. Use should be made of all information shown on the display, note being taken of the bearing and range of the intruder (amber circle), whether it is above or below (data tag), and its vertical speed direction (trend arrow).
 - (C) Other available information should be used to assist in visual acquisition, including ATC 'party-line' information, traffic flow in use, etc.
 - (D) Because of the limitations described, the pilot flying should not manoeuvre the aircraft based solely on the information shown on the ACAS display. No

attempt should be made to adjust the current flight path in anticipation of what an RA would advise, except that if own aircraft is approaching its cleared level at a high vertical rate with a TA present, vertical rate should be reduced to less than 1 500 ft/min.

- (E) When visual acquisition is attained, and as long as no RA is received, normal right of way rules should be used to maintain or attain safe separation. No unnecessary manoeuvres should be initiated. The limitations of making manoeuvres based solely on visual acquisition, especially at high altitude or at night, or without a definite horizon should be demonstrated as being understood.

(ii) RA responses

Objective: to verify that the pilot properly interprets and responds to RAs.

Criteria: the pilot should demonstrate the following:

- (A) Proper response to the RA, even if it is in conflict with an ATC instruction and even if the pilot believes that there is no threat present.
- (B) Proper task sharing between the pilot flying and the pilot monitoring. The pilot flying should respond to a corrective RA with appropriate control inputs. The pilot monitoring should monitor the response to the RA and should provide updates on the traffic location by checking the traffic display. Proper CRM should be used.
- (C) Proper interpretation of the displayed information. The pilot should recognise the intruder causing the RA to be issued (red square on display). The pilot should respond appropriately.
- (D) For corrective RAs, the response should be initiated in the proper direction within 5 seconds of the RA being displayed. The change in vertical speed should be accomplished with an acceleration of approximately $\frac{1}{4}$ g (gravitational acceleration of 9.81 m/sec^2).
- (E) Recognition of the initially displayed RA being modified. Response to the modified RA should be properly accomplished, as follows:
 - (a) For increase rate RAs, the vertical speed change should be started within $2\frac{1}{2}$ seconds of the RA being displayed. The change in vertical speed should be accomplished with an acceleration of approximately $\frac{1}{3}$ g.
 - (b) For RA reversals, the vertical speed reversal should be started within $2\frac{1}{2}$ seconds of the RA being displayed. The change in vertical speed should be accomplished with an acceleration of approximately $\frac{1}{3}$ g.
 - (c) For RA weakenings, the vertical speed should be modified to initiate a return towards the original clearance.
 - (d) An acceleration of approximately $\frac{1}{4}$ g will be achieved if the change in pitch attitude corresponding to a change in vertical speed of 1 500 ft/min is accomplished in approximately 5 seconds, and of $\frac{1}{3}$ g if the change is accomplished in approximately 3 seconds. The change in pitch attitude required to establish a rate of climb or descent of 1 500 ft/min from level flight will be approximately 6° when the true

airspeed (TAS) is 150 kt, 4° at 250 kt, and 2° at 500 kt. (These angles are derived from the formula: 1 000 divided by TAS.).

- (F) Recognition of altitude crossing encounters and the proper response to these RAs.
 - (G) For preventive RAs, the vertical speed needle or pitch attitude indication should remain outside the red area on the RA display.
 - (H) For maintain rate RAs, the vertical speed should not be reduced. Pilots should recognise that a maintain rate RA may result in crossing through the intruder's altitude.
 - (I) When the RA weakens, or when the green 'fly to' indicator changes position, the pilot should initiate a return towards the original clearance, and when 'clear of conflict' is annunciated, the pilot should complete the return to the original clearance.
 - (J) The controller should be informed of the RA as soon as time and workload permit, using the standard phraseology.
 - (K) When possible, an ATC clearance should be complied with while responding to an RA. For example, if the aircraft can level at the assigned altitude while responding to RA (an 'adjust vertical speed' RA (version 7) or 'level off' (version 7.1)), it should be done; the horizontal (turn) element of an ATC instruction should be followed.
 - (L) Knowledge of the ACAS multi-aircraft logic and its limitations, and that ACAS can optimise separations from two aircraft by climbing or descending towards one of them. For example, ACAS only considers intruders that it considers to be a threat when selecting an RA. As such, it is possible for ACAS to issue an RA against one intruder that results in a manoeuvre towards another intruder that is not classified as a threat. If the second intruder becomes a threat, the RA will be modified to provide separation from that intruder.
- (i) ACAS initial evaluation
- (1) The flight crew member's understanding of the academic training items should be assessed by means of a written test or interactive CBT that records correct and incorrect responses to phrased questions.
 - (2) The flight crew member's understanding of the manoeuvre training items should be assessed in a full flight simulator equipped with an ACAS display and controls similar in appearance and operation to those in the aircraft the flight crew member will fly, and the results assessed by a qualified instructor, inspector, or check airman. The range of scenarios should include: corrective RAs; initial preventive RAs; maintain rate RAs; altitude crossing RAs; increase rate RAs; RA reversals; weakening RAs; and multi-threat encounters. The scenarios should also include demonstrations of the consequences of not responding to RAs, slow or late responses, and manoeuvring opposite to the direction called for by the displayed RA.
 - (3) Alternatively, exposure to these scenarios can be conducted by means of an interactive CBT with an ACAS display and controls similar in appearance and operation to those in the aircraft the pilot will fly. This interactive CBT should depict scenarios in which real-time responses should be made and a record made of whether or not each response was correct.

(j) ACAS recurrent training

- (1) ACAS recurrent training ensures that flight crew members maintain the appropriate ACAS knowledge and skills. ACAS recurrent training should be integrated into and/or conducted in conjunction with other established recurrent training programmes. An essential item of recurrent training is the discussion of any significant issues and operational concerns that have been identified by the operator. Recurrent training should also address changes to ACAS logic, parameters or procedures and to any unique ACAS characteristics which flight crew members should be made aware of.
- (2) It is recommended that operator's recurrent training programmes using full flight simulators include encounters with conflicting traffic when these simulators are equipped with ACAS. The full range of likely scenarios may be spread over a 2 year period. If a full flight simulator, as described above, is not available, use should be made of an interactive CBT that is capable of presenting scenarios to which pilot responses should be made in real-time.

NCC.OP.225 Approach and landing conditions

Before commencing an approach to land, the pilot-in-command shall be satisfied that, according to the information available, the weather at the aerodrome or the operating site and the condition of the runway or FATO intended to be used would not prevent a safe approach, landing or missed approach.

AMC1 NCC.OP.225 Approach and landing conditions**LANDING DISTANCE/FATO SUITABILITY**

The in-flight determination of the landing distance/FATO suitability should be based on the latest available meteorological report.

NCC.OP.230 Commencement and continuation of approach

- (a) The pilot-in-command may commence an instrument approach regardless of the reported runway visual range/visibility (RVR/VIS).
- (b) If the reported RVR/VIS is less than the applicable minimum the approach shall not be continued:
 - (1) below 1 000 ft above the aerodrome; or
 - (2) into the final approach segment in the case where the decision altitude/height (DA/H) or minimum descent altitude/height (MDA/H) is more than 1 000 ft above the aerodrome.
- (c) Where the RVR is not available, RVR values may be derived by converting the reported visibility.
- (d) If, after passing 1 000 ft above the aerodrome, the reported RVR/VIS falls below the applicable minimum, the approach may be continued to DA/H or MDA/H.
- (e) The approach may be continued below DA/H or MDA/H and the landing may be completed provided that the visual reference adequate for the type of approach operation and for the intended runway is established at the DA/H or MDA/H and is maintained.
- (f) The touchdown zone RVR shall always be controlling.

AMC1 NCC.OP.230 Commencement and continuation of approach

VISUAL REFERENCES FOR INSTRUMENT APPROACH OPERATIONS

- (a) NPA, APV and CAT I operations

At DH or MDH, at least one of the visual references specified below should be distinctly visible and identifiable to the pilot:

 - (1) elements of the approach lighting system;
 - (2) the threshold;
 - (3) the threshold markings;
 - (4) the threshold lights;
 - (5) the threshold identification lights;
 - (6) the visual glide slope indicator;
 - (7) the touchdown zone or touchdown zone markings;
 - (8) the touchdown zone lights;
 - (9) FATO/runway edge lights; or
 - (10) other visual references specified in the operations manual.
- (b) Lower than standard category I (LTS CAT I) operations

At DH, the visual references specified below should be distinctly visible and identifiable to the pilot:

 - (1) a segment of at least three consecutive lights, being the centreline of the approach lights, or touchdown zone lights, or runway centreline lights, or runway edge lights, or a combination of these; and
 - (2) this visual reference should include a lateral element of the ground pattern, such as an approach light crossbar or the landing threshold or a barrette of the touchdown zone light unless the operation is conducted utilising an approved HUDLS usable to at least 150 ft.

(c) CAT II or OTS CAT II operations

At DH, the visual references specified below should be distinctly visible and identifiable to the pilot:

- (1) a segment of at least three consecutive lights, being the centreline of the approach lights, or touchdown zone lights, or runway centreline lights, or runway edge lights, or a combination of these; and
- (2) this visual reference should include a lateral element of the ground pattern, such as an approach light crossbar or the landing threshold or a barrette of the touchdown zone light unless the operation is conducted utilising an approved HUDLS to touchdown.

(d) CAT III operations

- (1) For CAT IIIA operations and for CAT IIIB operations conducted either with fail-passive flight control systems or with the use of an approved HUDLS: at DH, a segment of at least three consecutive lights, being the centreline of the approach lights, or touchdown zone lights, or runway centreline lights, or runway edge lights, or a combination of these is attained and can be maintained by the pilot.
- (2) For CAT IIIB operations conducted either with fail-operational flight control systems or with a fail-operational hybrid landing system using a DH: at DH, at least one centreline light is attained and can be maintained by the pilot.
- (3) For CAT IIIB operations with no DH there is no requirement for visual reference with the runway prior to touchdown.

(e) Approach operations utilising EVS – CAT I operations

- (1) At DH or MDH, the following visual references should be displayed and identifiable to the pilot on the EVS:
 - (i) elements of the approach light; or
 - (ii) the runway threshold, identified by at least one of the following:
 - (A) the beginning of the runway landing surface,
 - (B) the threshold lights, the threshold identification lights; or
 - (C) the touchdown zone, identified by at least one of the following: the runway touchdown zone landing surface, the touchdown zone lights, the touchdown zone markings or the runway lights.
- (2) At 100 ft above runway threshold elevation at least one of the visual references specified below should be distinctly visible and identifiable to the pilot without reliance on the EVS:
 - (i) the lights or markings of the threshold; or
 - (ii) the lights or markings of the touchdown zone.

(f) Approach operations utilising EVS – APV and NPA operations flown with the CDFA technique

- (1) At DH/MDH, visual references should be displayed and identifiable to the pilot on the EVS image as specified under (a).
- (2) At 200 ft above runway threshold elevation, at least one of the visual references specified under (a) should be distinctly visible and identifiable to the pilot without reliance on the EVS.

SUBPART C: AIRCRAFT PERFORMANCE AND OPERATING LIMITATIONS

NCC.POL.100 Operating limitations — all aircraft

- (a) During any phase of operation, the loading, the mass and the centre of gravity (CG) position of the aircraft shall comply with any limitation specified in the AFM, or the operations manual, if more restrictive.
- (b) Placards, listings, instrument markings, or combinations thereof, containing those operating limitations prescribed by the AFM for visual presentation, shall be displayed in the aircraft.

NCC.POL.105 Mass and balance, loading

- (a) The operator shall establish the mass and the CG of any aircraft by actual weighing prior to initial entry into service. The accumulated effects of modifications and repairs on the mass and balance shall be accounted for and properly documented. Aircraft shall be reweighed if the effect of modifications on the mass and balance is not accurately known.
- (b) The weighing shall be accomplished by the manufacturer of the aircraft or by an approved maintenance organisation.
- (c) The operator shall determine the mass of all operating items and crew members included in the aircraft dry operating mass by actual weighing, including any crew baggage, or by using standard masses. The influence of their position on the aircraft's CG shall be determined. When using standard masses the following mass values for crew members shall be used to determine the dry operating mass:
 - (1) 85 kg, including hand baggage, for flight crew/technical crew members; and
 - (2) 75 kg for cabin crew members.
- (d) The operator shall establish procedures to enable the pilot-in-command to determine the mass of the traffic load, including any ballast, by:
 - (1) actual weighing;
 - (2) determining the mass of the traffic load in accordance with standard passenger and baggage masses; or
 - (3) calculating passenger mass on the basis of a statement by, or on behalf of, each passenger and adding to it a predetermined mass to account for hand baggage and clothing, when the number of passenger seats available on the aircraft is:
 - (i) less than 10 for aeroplanes; or
 - (ii) less than six for helicopters.
- (e) When using standard masses the following mass values shall be used:
 - (1) for passengers, those in Tables 1 and 2, where hand baggage and the mass of any infant carried by an adult on one passenger seat are included:

Table 1

Standard masses for passengers — aircraft with a total number of passenger seats of 20 or more

Passenger seats	20 and more		30 and more
	Male	Female	All adult
Adults	88 kg	70 kg	84 kg
Children	35 kg	35 kg	35 kg

Table 2

Standard masses for passengers — aircraft with a total number of passenger seats of 19 or less

Passenger seats	1 – 5	6 – 9	10 – 19
Male	104 kg	96 kg	92 kg
Female	86 kg	78 kg	74 kg
Children	35 kg	35 kg	35 kg

- (2) for baggage:
- (i) for aeroplanes, when the total number of passenger seats available on the aeroplane is 20 or more, standard mass values for checked baggage in Table 3;

Table 3

Standard masses for baggage — aeroplanes with a total number of passenger seats of 20 or more

Type of flight	Baggage standard mass
Domestic	11 kg
Within the European region	13 kg
Intercontinental	15 kg
All other	13 kg

- (ii) for helicopters, when the total number of passenger seats available on the helicopters is 20 or more, the standard mass value for checked baggage of 13 kg.
- (f) For aircraft with 19 passenger seats or less, the actual mass of checked baggage shall be determined:
 - (1) by weighing; or
 - (2) by calculation on the basis of a statement by, or on behalf of, each passenger. Where this is impractical, a minimum standard mass of 13 kg shall be used.
- (g) The operator shall establish procedures to enable the pilot-in-command to determine the mass of the fuel load by using the actual density or, if not known, the density calculated in accordance with a method specified in the operations manual.
- (h) The pilot-in-command shall ensure that the loading of:
 - (1) the aircraft is performed under the supervision of qualified personnel; and
 - (2) traffic load is consistent with the data used for the calculation of the aircraft mass and balance.
- (i) The operator shall establish procedures to enable the pilot-in-command to comply with additional structural limits such as the floor strength limitations, the maximum load per running metre, the maximum mass per cargo compartment and the maximum seating limit.
- (j) The operator shall specify, in the operations manual, the principles and methods involved in the loading and in the mass and balance system that meet the requirements contained in (a) to (i). This system shall cover all types of intended operations.

AMC1 NCC.POL.105(a) Mass and balance, loading

CENTRE OF GRAVITY LIMITS — OPERATIONAL CG ENVELOPE AND IN-FLIGHT CG

In the Certificate Limitations section of the AFM, forward and aft CG limits are specified. These limits ensure that the certification stability and control criteria are met throughout the whole flight and allow the proper trim setting for take-off. The operator should ensure that these limits are respected by:

- (a) Defining and applying operational margins to the certified CG envelope in order to compensate for the following deviations and errors:
 - (1) Deviations of actual CG at empty or operating mass from published values due, for example, to weighing errors, unaccounted modifications and/or equipment variations.
 - (2) Deviations in fuel distribution in tanks from the applicable schedule.
 - (3) Deviations in the distribution of baggage and cargo in the various compartments as compared with the assumed load distribution as well as inaccuracies in the actual mass of baggage and cargo.
 - (4) Deviations in actual passenger seating from the seating distribution assumed when preparing the mass and balance documentation. Large CG errors may occur when 'free seating', i.e. freedom of passengers to select any seat when entering the aircraft, is permitted. Although in most cases reasonably even longitudinal passenger seating can be expected, there is a risk of an extreme forward or aft seat selection causing very large and unacceptable CG errors, assuming that the balance calculation is done on the basis of an assumed even distribution. The largest errors may occur at a load factor of approximately 50 % if all passengers are seated in either the forward or aft half of the cabin. Statistical

analysis indicates that the risk of such extreme seating adversely affecting the CG is greatest on small aircraft.

- (5) Deviations of the actual CG of cargo and passenger load within individual cargo compartments or cabin sections from the normally assumed mid position.
 - (6) Deviations of the CG caused by gear and flap positions and by application of the prescribed fuel usage procedure, unless already covered by the certified limits.
 - (7) Deviations caused by in-flight movement of cabin crew, galley equipment and passengers.
- (b) Defining and applying operational procedures in order to:
- (1) ensure an even distribution of passengers in the cabin;
 - (2) take into account any significant CG travel during flight caused by passenger/crew movement; and
 - (3) take into account any significant CG travel during flight caused by fuel consumption/transfer.

AMC1 NCC.POL.105(b) Mass and balance, loading

WEIGHING OF AN AIRCRAFT

- (a) New aircraft that have been weighed at the factory may be placed into operation without reweighing if the mass and balance records have been adjusted for alterations or modifications to the aircraft. Aircraft transferred from one EU operator to another EU operator do not have to be weighed prior to use by the receiving operator, unless the mass and balance cannot be accurately established by calculation.
- (b) The mass and centre of gravity (CG) position of an aircraft should be revised whenever the cumulative changes to the dry operating mass exceed $\pm 0.5\%$ of the maximum landing mass or for aeroplanes the cumulative change in CG position exceeds 0.5% of the mean aerodynamic chord. This should be done either by weighing the aircraft or by calculation.
- (c) When weighing an aircraft, normal precautions should be taken, which are consistent with good practices such as:
 - (1) checking for completeness of the aircraft and equipment;
 - (2) determining that fluids are properly accounted for;
 - (3) ensuring that the aircraft is clean; and
 - (4) ensuring that weighing is accomplished in an enclosed building.
- (d) Any equipment used for weighing should be properly calibrated, zeroed and used in accordance with the manufacturer's instructions. Each scale should be calibrated either by the manufacturer, by a civil department of weights and measures or by an appropriately authorised organisation within 2 years or within a time period defined by the manufacturer of the weighing equipment, whichever is less. The equipment should enable the mass of the aircraft to be established accurately. One single accuracy criterion for weighing equipment cannot be given. However, the weighing accuracy is considered satisfactory if the accuracy criteria in Table 1 are met by the individual scales/cells of the weighing equipment used:

Table 1: Accuracy criteria for weighing equipment

For a scale/cell load	An accuracy of
below 2 000 kg	$\pm 1 \%$
from 2 000 kg to 20 000 kg	$\pm 20 \text{ kg}$
above 20 000 kg	$\pm 0.1 \%$

AMC1 NCC.POL.105(c) Mass and balance, loading

DRY OPERATING MASS

- (a) The dry operating mass should include:
- (1) crew and crew baggage;
 - (2) catering and removable passenger service equipment; and
 - (3) tank water and lavatory chemicals.
- (b) The operator should correct the dry operating mass to account for any additional crew baggage. The position of this additional baggage should be accounted for when establishing the centre of gravity of the aircraft.
- (c) The operator should establish a procedure in the operations manual to determine when to select actual or standard masses for crew members.
- (d) When determining the actual mass by weighing, crew members' personal belongings and hand baggage should be included. Such weighing should be conducted immediately prior to boarding the aircraft.

AMC1 NCC.POL.105(d) Mass and balance, loading

MASS VALUES FOR PASSENGERS AND BAGGAGE

- (a) The predetermined mass for hand baggage and clothing should be established by the operator on the basis of studies relevant to its particular operation. In any case, it should not be less than:
- (1) 4 kg for clothing; and
 - (2) 6 kg for hand baggage.
- The passengers' stated mass and the mass of passengers' clothing and hand baggage should be checked prior to boarding and adjusted, if necessary. The operator should establish a procedure in the operations manual when to select actual or standard masses and the procedure to be followed when using verbal statements.
- (b) When determining the actual mass by weighing, passengers' personal belongings and hand baggage should be included. Such weighing should be conducted immediately prior to boarding the aircraft.
- (c) When determining the mass of passengers by using standard mass values, provided in Tables 1 and 2 of NCC.POL.105(e), infants occupying separate passenger seats should be considered as children for the purpose of this AMC. When the total number of passenger seats available on an aircraft is 20 or more, the standard masses for males and females in Table 1 of NCC.POL.105(e)

should be used. As an alternative, in cases where the total number of passenger seats available is 30 or more, the 'All Adult' mass values in Table 1 of NCC.POL.105(e) may be used.

On aeroplane flights with 19 passenger seats or less and all helicopter flights where no hand baggage is carried in the cabin or where hand baggage is accounted for separately, 6 kg may be deducted from male and female masses in Table 2 of NCC.POL.105(e). Articles such as an overcoat, an umbrella, a small handbag or purse, reading material or a small camera are not considered as hand baggage.

For helicopter operations in which a survival suit is provided to passengers, 3 kg should be added to the passenger mass value.

(d) Mass values for baggage.

The mass of checked baggage should be checked prior to loading and increased, if necessary.

(e) On any flight identified as carrying a significant number of passengers whose masses, including hand baggage, are expected to significantly deviate from the standard passenger mass, the operator should determine the actual mass of such passengers by weighing or by adding an adequate mass increment.

(f) If standard mass values for checked baggage are used and a significant number of passengers' checked baggage is expected to significantly deviate from the standard baggage mass, the operator should determine the actual mass of such baggage by weighing or by adding an adequate mass increment.

GM1 NCC.POL.105(d) Mass and balance, loading

ADJUSTMENT OF STANDARD MASSES

When standard mass values are used, item (e) of AMC1 NCC.POL.105(d) states that the operator should identify and adjust the passenger and checked baggage masses in cases where significant numbers of passengers or quantities of baggage are suspected of significantly deviating from the standard values. Therefore, the operations manual should contain instructions to ensure that:

- (a) check-in, operations and loading personnel as well as cabin and flight crew report or take appropriate action when a flight is identified as carrying a significant number of passengers whose masses, including hand baggage, are expected to significantly deviate from the standard passenger mass, and/or groups of passengers carrying exceptionally heavy baggage; and
- (b) on small aircraft, where the risks of overload and/or CG errors are the greatest, pilots pay special attention to the load and its distribution and make proper adjustments.

GM1 NCC.POL.105(e) Mass and balance, loading

TYPE OF FLIGHTS

- (a) For the purpose of Table 3 of NCC.POL.105(e):
 - (1) domestic flight means a flight with origin and destination within the borders of one State.
 - (2) flights within the European region means flights, other than domestic flights, whose origin and destination are within the area specified in item (b).
 - (3) Intercontinental flight means flights beyond the European region with origin and destination in different continents.
- (b) Flights within the European region are flights conducted within the following area:

- N7200 E04500
- N4000 E04500
- N3500 E03700
- N3000 E03700
- N3000 W00600
- N2700 W00900
- N2700 W03000
- N6700 W03000
- N7200 W01000
- N7200 E04500

as depicted in Figure 1: European region.

Figure 1: European region

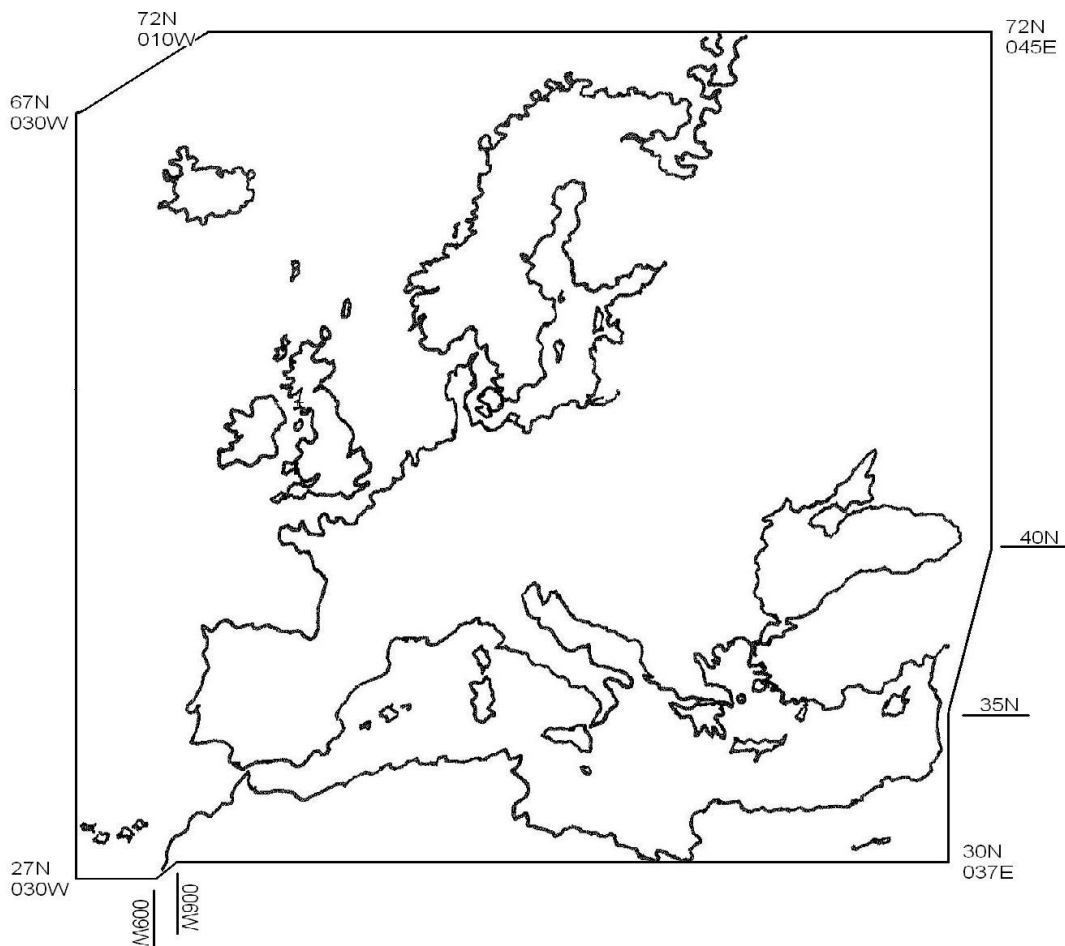

GM1 NCC.POL.105(g) Mass and balance, loading

FUEL DENSITY

- (a) If the actual fuel density is not known, the operator may use standard fuel density values for determining the mass of the fuel load. Such standard values should be based on current fuel density measurements for the airports or areas concerned.

(b) Typical fuel density values are:

(1)	Gasoline (reciprocating engine fuel) –	0.71
(2)	JET A1 (Jet fuel JP 1) –	0.79
(3)	JET B (Jet fuel JP 4) –	0.76
(4)	Oil –	0.88

NCC.POL.110 Mass and balance data and documentation

- (a) The operator shall establish mass and balance data and produce mass and balance documentation prior to each flight specifying the load and its distribution in such a way that the mass and balance limits of the aircraft are not exceeded. The mass and balance documentation shall contain the following information:
- (1) aircraft registration and type;
 - (2) flight identification, number and date, as applicable;
 - (3) name of the pilot-in-command;
 - (4) name of the person who prepared the document;
 - (5) dry operating mass and the corresponding CG of the aircraft;
 - (6) mass of the fuel at take-off and the mass of trip fuel;
 - (7) mass of consumables other than fuel, if applicable;
 - (8) load components including passengers, baggage, freight and ballast;
 - (9) take-off mass, landing mass and zero fuel mass;
 - (10) applicable aircraft CG positions; and
 - (11) the limiting mass and CG values.
- (b) Where mass and balance data and documentation are generated by a computerised mass and balance system, the operator shall verify the integrity of the output data.
- (c) When the loading of the aircraft is not supervised by the pilot-in-command, the person supervising the loading of the aircraft shall confirm by hand signature or equivalent that the load and its distribution are in accordance with the mass and balance documentation established by the pilot-in-command. The pilot-in-command shall indicate his/her acceptance by hand signature or equivalent.
- (d) The operator shall specify procedures for last minute changes to the load to ensure that:
- (1) any last minute change after the completion of the mass and balance documentation is entered in the flight planning documents containing the mass and balance documentation;
 - (2) the maximum last minute change allowed in passenger numbers or hold load is specified; and
 - (3) new mass and balance documentation is prepared if this maximum number is exceeded.

AMC1 NCC.POL.110(a) Mass and balance data and documentation**CONTENTS**

The mass and balance documentation should include advice to the pilot-in-command whenever a non-standard method has been used for determining the mass of the load.

AMC2 NCC.POL.110(b) Mass and balance data and documentation**INTEGRITY**

The operator should verify the integrity of mass and balance data and documentation generated by a computerised mass and balance system, at intervals not exceeding 6 months. The operator should

establish a system to check that amendments of its input data are incorporated properly in the system and that the system is operating correctly on a continuous basis.

AMC1 NCC.POL.110(c) Mass and balance data and documentation

SIGNATURE OR EQUIVALENT

Where a signature by hand is impracticable or it is desirable to arrange the equivalent verification by electronic means, the following conditions should be applied in order to make an electronic signature the equivalent of a conventional hand-written signature:

- (a) electronic 'signing' by entering a personal identification number (PIN) code with appropriate security, etc.;
- (b) entering the PIN code generates a print-out of the individual's name and professional capacity on the relevant document(s) in such a way that it is evident, to anyone having a need for that information, who has signed the document;
- (c) the computer system logs information to indicate when and where each PIN code has been entered;
- (d) the use of the PIN code is, from a legal and responsibility point of view, considered to be fully equivalent to signature by hand;
- (e) the requirements for record keeping remain unchanged; and
- (f) all personnel concerned are made aware of the conditions associated with electronic signature and this is documented.

AMC2 NCC.POL.110(c) Mass and balance data and documentation

MASS AND BALANCE DOCUMENTATION SENT VIA DATA LINK

Whenever the mass and balance documentation is sent to the aircraft via data link, a copy of the final mass and balance documentation as accepted by the pilot-in-command should be available on the ground.

GM1 NCC.POL.110(b) Mass and balance data and documentation

ON-BOARD INTEGRATED MASS AND BALANCE COMPUTER SYSTEM

An on-board integrated mass and balance computer system may be an aircraft installed system capable of receiving input data either from other aircraft systems or from a mass and balance system on the ground, in order to generate mass and balance data as an output.

GM2 NCC.POL.110(b) Mass and balance data and documentation

STAND-ALONE COMPUTERISED MASS AND BALANCE SYSTEM

A stand-alone computerised mass and balance system may be a computer, either as part of an electronic flight bag (EFB) system or solely dedicated to mass and balance purposes, requiring input from the user, in order to generate mass and balance data as an output.

NCC.POL.111 Mass and balance data and documentation — alleviations

Notwithstanding NCC.POL.110 (a)(5), the CG position may not need to be on the mass and balance documentation, if the load distribution is in accordance with a pre-calculated balance table or if it can be shown that for the planned operations a correct balance can be ensured, whatever the real load is.

NCC.POL.115 Performance — general

The pilot-in-command shall only operate the aircraft if the performance is adequate to comply with the applicable rules of the air and any other restrictions applicable to the flight, the airspace or the aerodromes or operating sites used, taking into account the charting accuracy of any charts and maps used.

NCC.POL.120 Take-off mass limitations — aeroplanes

The operator shall ensure that:

- (a) the mass of the aeroplane at the start of take-off shall not exceed the mass limitations:
 - (1) at take-off as required in NCC.POL.125;
 - (2) en-route with one engine inoperative (OEI) as required in NCC.POL.130; and
 - (3) at landing as required in NCC.POL.135;allowing for expected reductions in mass as the flight proceeds and for fuel jettisoning;
- (b) the mass at the start of take-off shall never exceed the maximum take-off mass specified in the AFM for the pressure altitude appropriate to the elevation of the aerodrome or operating site, and if used as a parameter to determine the maximum take-off mass, any other local atmospheric condition; and
- (c) the estimated mass for the expected time of landing at the aerodrome or operating site of intended landing and at any destination alternate aerodrome shall never exceed the maximum landing mass specified in the AFM for the pressure altitude appropriate to the elevation of those aerodromes or operating sites, and if used as a parameter to determine the maximum landing mass, any other local atmospheric condition.

NCC.POL.125 Take-off — aeroplanes

- (a) When determining the maximum take-off mass, the pilot-in-command shall take the following into account:
 - (1) the calculated take-off distance shall not exceed the take-off distance available with a clearway distance not exceeding half of the take-off run available;
 - (2) the calculated take-off run shall not exceed the take-off run available;
 - (3) a single value of V_1 shall be used for the rejected and continued take-off, where a V_1 is specified in the AFM; and
 - (4) on a wet or contaminated runway, the take-off mass shall not exceed that permitted for a take-off on a dry runway under the same conditions.
- (b) Except for an aeroplane equipped with turboprop engines and a maximum take-off mass at or below 5 700 kg, in the event of an engine failure during take-off, the pilot-in-command shall ensure that the aeroplane is able:

- (1) to discontinue the take-off and stop within the accelerate-stop distance available or the runway available; or
- (2) to continue the take-off and clear all obstacles along the flight path by an adequate margin until the aeroplane is in a position to comply with NCC.POL.130.

AMC1 NCC.POL.125 Take-off — aeroplanes

TAKE-OFF MASS

The following should be considered for determining the maximum take-off mass:

- (a) the pressure altitude at the aerodrome;
- (b) the ambient temperature at the aerodrome;
- (c) the runway surface condition and the type of runway surface;
- (d) the runway slope in the direction of take-off;
- (e) not more than 50 % of the reported head-wind component or not less than 150 % of the reported tailwind component; and
- (f) the loss, if any, of runway length due to alignment of the aeroplane prior to take-off.

AMC2 NCC.POL.125 Take-off — aeroplanes

CONTAMINATED RUNWAY PERFORMANCE DATA

Wet and contaminated runway performance data, if made available by the manufacturer, should be taken into account. If such data is not made available, the operator should account for wet and contaminated runway conditions by using the best information available.

AMC3 NCC.POL.125 Take-off — aeroplanes

ADEQUATE MARGIN

The adequate margin should be defined in the operations manual.

GM1 NCC.POL.125 Take-off — aeroplanes

RUNWAY SURFACE CONDITION

Operation on runways contaminated with water, slush, snow or ice implies uncertainties with regard to runway friction and contaminant drag and therefore to the achievable performance and control of the aeroplane during take-off or landing, since the actual conditions may not completely match the assumptions on which the performance information is based. In the case of a contaminated runway, the first option for the pilot-in-command is to wait until the runway is cleared. If this is impracticable, he/she may consider a take-off or landing, provided that he/she has applied the applicable performance adjustments, and any further safety measures he/she considers justified under the prevailing conditions. The excess runway length available including the criticality of the overrun area should also be considered.

GM2 NCC.POL.125 Take-off — aeroplanes

ADEQUATE MARGIN

‘An adequate margin’ is illustrated by the appropriate examples included in Attachment C to ICAO Annex 6, Part I.

NCC.POL.130 En-route — one engine inoperative — aeroplanes

The pilot-in-command shall ensure that in the event of an engine becoming inoperative at any point along the route, a multi-engined aeroplane shall be able to continue the flight to an adequate aerodrome or operating site without flying below the minimum obstacle clearance altitude at any point.

NCC.POL.135 Landing — aeroplanes

The pilot-in-command shall ensure that at any aerodrome or operating site, after clearing all obstacles in the approach path by a safe margin, the aeroplane shall be able to land and stop, or a seaplane to come to a satisfactorily low speed, within the landing distance available. Allowance shall be made for expected variations in the approach and landing techniques, if such allowance has not been made in the scheduling of performance data.

AMC1 NCC.POL.135 Landing — aeroplanes

GENERAL

The following should be considered to ensure that an aeroplane is able to land and stop, or a seaplane to come to a satisfactorily low speed, within the landing distance available:

- (a) the pressure altitude at the aerodrome;
- (b) the runway surface condition and the type of runway surface;
- (c) the runway slope in the direction of landing;
- (d) not more than 50 % of the reported head-wind component or not less than 150 % of the reported tailwind component; and
- (e) use of the most favourable runway, in still air;
- (f) use of the runway most likely to be assigned considering the probable wind speed and direction and the ground handling characteristics of the aeroplane, and considering other conditions such as landing aids and terrain.

AMC2 NCC.POL.135 Landing — aeroplanes

ALLOWANCES

The allowances should be stated in the operations manual.

SUBPART D: INSTRUMENTS, DATA AND EQUIPMENT

SECTION 1 Aeroplanes

NCC.IDE.A.100 Instruments and equipment — general

- (a) Instruments and equipment required by this Subpart shall be approved in accordance with the applicable airworthiness requirements if they are:
- (1) used by the flight crew to control the flight path;
 - (2) used to comply with NCC.IDE.A.245;
 - (3) used to comply with NCC.IDE.A.250; or
 - (4) installed in the aeroplane.
- (b) The following items, when required by this Subpart, do not need an equipment approval:
- (1) spare fuses;
 - (2) independent portable lights;
 - (3) an accurate time piece;
 - (4) chart holder;
 - (5) first-aid kits;
 - (6) survival and signalling equipment;
 - (7) sea anchor and equipment for mooring; and
 - (8) child restraint device.
- (c) Instruments and equipment not required by this Subpart as well as any other equipment which is not required by other applicable Annexes, but is carried on a flight, shall comply with the following:
- (1) the information provided by these instruments, equipment or accessories shall not be used by the flight crew to comply with Annex I to Regulation (EC) No 216/2008 or NCC.IDE.A.245 and NCC.IDE.A.250; and
 - (2) the instruments and equipment shall not affect the airworthiness of the aeroplane, even in the case of failures or malfunction.
- (d) Instruments and equipment shall be readily operable or accessible from the station where the flight crew member that needs to use it is seated.
- (e) Those instruments that are used by a flight crew member shall be so arranged as to permit the flight crew member to see the indications readily from his/her station, with the minimum practicable deviation from the position and line of vision which he/she normally assumes when looking forward along the flight path.
- (f) All required emergency equipment shall be easily accessible for immediate use.

GM1 NCC.IDE.A.100(a) Instruments and equipment — general

APPLICABLE AIRWORTHINESS REQUIREMENTS

The applicable airworthiness requirements for approval of instruments and equipment required by this Part are the following:

- (a) Regulation (EC) 748/2012⁴ for:
 - (1) aeroplanes registered in the EU; and
 - (2) aeroplanes registered outside the EU but manufactured or designed by an EU organisation.
- (b) Airworthiness requirements of the state of registry for aeroplanes registered, designed and manufactured outside the EU.

GM1 NCC.IDE.A.100(b)&(c) Instruments and equipment — general

INSTRUMENTS AND EQUIPMENT THAT DO NOT NEED TO BE APPROVED

- (a) The provision of this paragraph does not exempt the item of equipment from complying with the applicable airworthiness requirements if the instrument or equipment is installed in the aeroplane. In this case, the installation should be approved as required in the applicable airworthiness requirements and should comply with the applicable Certification Specifications.
- (b) The functionality of non-installed instruments and equipment required by this Part that do not need an equipment approval should be checked against recognised industry standards appropriate for the intended purpose. The operator is responsible for ensuring the maintenance of these instruments and equipment.
- (c) The failure of additional non-installed instruments or equipment not required by this Part or by the applicable airworthiness requirements or any applicable airspace requirements should not adversely affect the airworthiness and/or the safe operation of the aircraft. Examples are the following:
 - (1) instruments supplying additional flight information (e.g. stand-alone global positioning system (GPS));
 - (2) mission dedicated equipment (e.g. radios); and
 - (3) non-installed passenger entertainment equipment.

GM1 NCC.IDE.A.100(d) Instruments and equipment — general

POSITIONING OF INSTRUMENTS

This requirement implies that whenever a single instrument is required in an aeroplane operated in a multi-crew environment, the instrument needs to be visible from each flight crew station.

⁴ Commission Regulation (EU) No 748/2012 of 3 August 2012 laying down implementing rules for the airworthiness and environmental certification of aircraft and related products, parts and appliances, as well as for the certification of design and production organisations (OJ L 224, 21.8.2012, p. 1).

NCC.IDE.A.105 Minimum equipment for flight

A flight shall not be commenced when any of the aeroplane's instruments, items of equipment, or functions, required for the intended flight are inoperative or missing, unless:

- (a) the aeroplane is operated in accordance with the operator's minimum equipment list (MEL);
- (b) the operator is approved by the competent authority to operate the aeroplane within the constraints of the master minimum equipment list (MMEL); or
- (c) the aeroplane is subject to a permit to fly issued in accordance with the applicable airworthiness requirements.

NCC.IDE.A.110 Spare electrical fuses

Aeroplanes shall be equipped with spare electrical fuses, of the ratings required for complete circuit protection, for replacement of those fuses that are allowed to be replaced in flight.

GM1 NCC.IDE.A.110 Spare electrical fuses**FUSES**

A spare electrical fuse means a replaceable fuse in the flight crew compartment, not an automatic circuit breaker or circuit breakers in the electric compartments.

NCC.IDE.A.115 Operating lights

Aeroplanes operated at night shall be equipped with:

- (a) an anti-collision light system;
- (b) navigation/position lights;
- (c) a landing light;
- (d) lighting supplied from the aeroplane's electrical system to provide adequate illumination for all instruments and equipment essential to the safe operation of the aeroplane;
- (e) lighting supplied from the aeroplane's electrical system to provide illumination in all passenger compartments;
- (f) an independent portable light for each crew member station; and
- (g) lights to conform with the International Regulations for Preventing Collisions at Sea if the aeroplane is operated as a seaplane.

NCC.IDE.A.120 Operations under VFR — flight and navigational instruments and associated equipment

- (a) Aeroplanes operated under VFR by day shall be equipped with a means of measuring and displaying the following:
 - (1) magnetic-heading;
 - (2) time in hours, minutes and seconds;
 - (3) pressure altitude;
 - (4) indicated airspeed;
 - (5) slip; and
 - (6) Mach number whenever speed limitations are expressed in terms of Mach number.
- (b) Aeroplanes operated under visual meteorological conditions (VMC) over water and out of sight of the land, or under VMC at night, or in conditions where the aeroplane cannot be maintained in a desired flight path without reference to one or more additional instruments, shall be, in addition to (a), equipped with:
 - (1) a means of measuring and displaying the following:
 - (i) turn and slip;
 - (ii) attitude;
 - (iii) vertical speed; and
 - (iv) stabilised heading;
 - (2) a means of indicating when the supply of power to the gyroscopic instruments is not adequate; and
 - (3) a means of preventing malfunction of the airspeed indicating system required in (a)(4) due to condensation or icing.
- (c) Whenever two pilots are required for the operation, aeroplanes shall be equipped with an additional separate means of displaying the following:
 - (1) pressure altitude;

- (2) indicated airspeed;
- (3) slip, or turn and slip, as applicable;
- (4) attitude, if applicable;
- (5) vertical speed, if applicable;
- (6) stabilised heading, if applicable; and
- (7) Mach number whenever speed limitations are expressed in terms of Mach number, if applicable.

AMC1 NCC.IDE.A.120&NCC.IDE.A.125 Operations under VFR & operations under IFR — flight and navigational instruments and associated equipment

INTEGRATED INSTRUMENTS

- (a) Individual equipment requirements may be met by combinations of instruments, by integrated flight systems or by a combination of parameters on electronic displays. The information so available to each required pilot should not be less than that required in the applicable operational requirements, and the equivalent safety of the installation should be approved during type certification of the aeroplane for the intended type of operation.
- (b) The means of measuring and indicating turn and slip, aeroplane attitude and stabilised aeroplane heading may be met by combinations of instruments or by integrated flight director systems, provided that the safeguards against total failure, inherent in the three separate instruments, are retained.

AMC2 NCC.IDE.A.120 Operations under VFR — flight and navigational instruments and associated equipment

LOCAL FLIGHTS

For flights that do not exceed 60 minutes' duration, that take off and land at the same aerodrome and that remain within 50 NM of that aerodrome, an equivalent means of complying with NCC.IDE.A.120 (a)(5) & (b)(1)(i) may be:

- (a) a turn and slip indicator;
- (b) a turn coordinator; or
- (c) both an attitude indicator and a slip indicator.

AMC1 NCC.IDE.A.120(a)(1)&NCC.IDE.A.125(a)(1) Operations under VFR & operations under IFR — flight and navigational instruments and associated equipment

MEANS OF MEASURING AND DISPLAYING MAGNETIC HEADING

The means of measuring and displaying magnetic heading should be a magnetic compass or equivalent.

AMC1 NCC.IDE.A.120(a)(2)&NCC.IDE.A.125(a)(2) Operations under VFR & operations under IFR — flight and navigational instruments and associated equipment

MEANS OF MEASURING AND DISPLAYING THE TIME

An acceptable means of compliance is a clock displaying hours, minutes and seconds, with a sweep-second pointer or digital presentation.

AMC1 NCC.IDE.A.120(a)(3)&NCC.IDE.A.125(a)(3) Operations under VFR & operations under IFR — flight and navigational instruments and associated equipment

CALIBRATION OF THE MEANS FOR MEASURING AND DISPLAYING PRESSURE ALTITUDE

The instrument measuring and displaying pressure altitude should be of a sensitive type calibrated in feet (ft), with a sub-scale setting, calibrated in hectopascals/millibars, adjustable for any barometric pressure likely to be set during flight.

NCC.IDE.A.125 Operations under IFR — flight and navigational instruments and associated equipment

Aeroplanes operated under IFR shall be equipped with:

- (a) a means of measuring and displaying the following:
 - (1) magnetic heading;
 - (2) time in hours, minutes and seconds;
 - (3) pressure altitude;
 - (4) indicated airspeed;
 - (5) vertical speed;
 - (6) turn and slip;
 - (7) attitude;
 - (8) stabilised heading;
 - (9) outside air temperature; and
 - (10) Mach number whenever speed limitations are expressed in terms of Mach number;
- (b) a means of indicating when the supply of power to the gyroscopic instruments is not adequate;
- (c) whenever two pilots are required for the operation, an additional separate means of displaying for the second pilot:
 - (1) pressure altitude;
 - (2) indicated airspeed;
 - (3) vertical speed;
 - (4) turn and slip;
 - (5) attitude;
 - (6) stabilised heading; and
 - (7) Mach number whenever speed limitations are expressed in terms of Mach number, if applicable;
- (d) a means of preventing malfunction of the airspeed indicating systems required in (a)(4) and (c)(2) due to condensation or icing;
- (e) an alternate source of static pressure;
- (f) a chart holder in an easily readable position that can be illuminated for night operations;
- (g) a second independent means of measuring and displaying altitude; and
- (h) an emergency power supply, independent of the main electrical generating system, for the purpose of operating and illuminating an attitude indicating system for a minimum period of 30 minutes. The emergency power supply shall be automatically operative after the total failure of the main electrical generating system and clear indication shall be given on the instrument that the attitude indicator is being operated by emergency power.

AMC2 NCC.IDE.A.125(a)(3) Operations under IFR — flight and navigational instruments and associated equipment**ALTIMETERS — IFR OR NIGHT OPERATIONS**

Except for unpressurised aeroplanes operating below 10 000 ft, the altimeters of aeroplanes operating under IFR or at night should have counter drum-pointer or equivalent presentation.

AMC1 NCC.IDE.A.120(a)(4)&NCC.IDE.A.125(a)(4) Operations under VFR & operations under IFR — flight and navigational instruments and associated equipment**CALIBRATION OF THE INSTRUMENT INDICATING AIRSPEED**

The instrument indicating airspeed should be calibrated in knots (kt).

AMC1 NCC.IDE.A.120(c)&NCC.IDE.A.125(c) Operations under VFR & operations under IFR — flight and navigational instruments and associated equipment**MULTI-PILOT OPERATIONS – DUPLICATE INSTRUMENTS**

Duplicate instruments include separate displays for each pilot and separate selectors or other associated equipment where appropriate.

AMC1 NCC.IDE.A.125(a)(9) Operations under IFR — flight and navigational instruments and associated equipment**MEANS OF DISPLAYING OUTSIDE AIR TEMPERATURE**

- (a) The means of displaying outside air temperature should be calibrated in degrees Celsius.
- (b) The means of displaying outside air temperature may be an air temperature indicator that provides indications that are convertible to outside air temperature.

AMC1 NCC.IDE.A.125(d) Operations under IFR — flight and navigational instruments and associated equipment**MEANS OF PREVENTING MALFUNCTION DUE TO CONDENSATION OR ICING**

The means of preventing malfunction due to either condensation or icing of the airspeed indicating system should be a heated pitot tube or equivalent.

AMC1 NCC.IDE.A.125(f) Operations under IFR — flight and navigational instruments and associated equipment**CHART HOLDER**

An acceptable means of compliance with the chart holder requirement is to display a pre-composed chart on an electronic flight bag (EFB).

NCC.IDE.A.130 Additional equipment for single-pilot operations under IFR

Aeroplanes operated under IFR with a single pilot shall be equipped with an autopilot with at least altitude hold and heading mode.

NCC.IDE.A.135 Terrain awareness warning system (TAWS)

Turbine-powered aeroplanes with a maximum certified take-off mass (MCTOM) of more than 5 700 kg or a maximum operational passenger seating configuration (MOPSC) of more than nine shall be equipped with a TAWS that meets the requirements for:

- (a) class A equipment, as specified in an acceptable standard, in the case of aeroplanes for which the individual certificate of airworthiness (CofA) was first issued after 1 January 2011; or
- (b) class B equipment, as specified in an acceptable standard, in the case of aeroplanes for which the individual CofA was first issued on or before 1 January 2011.

AMC1 NCC.IDE.A.135 Terrain awareness warning system (TAWS)**EXCESSIVE DOWNWARDS GLIDESLOPE DEVIATION WARNING FOR CLASS A TAWS**

The requirement for a Class A TAWS to provide a warning to the flight crew for excessive downwards glideslope deviation should apply to all final approach glideslopes with angular vertical navigation (VNAV) guidance, whether provided by the instrument landing system (ILS), microwave landing system (MLS), satellite-based augmentation system approach procedure with vertical guidance (SBAS APV (localiser performance with vertical guidance approach LPV)), ground-based augmentation system (GBAS (GPS landing system, GLS)) or any other systems providing similar guidance. The same requirement should not apply to systems providing vertical guidance based on barometric VNAV.

GM1 NCC.IDE.A.135 Terrain awareness warning system (TAWS)**ACCEPTABLE STANDARD FOR TAWS**

An acceptable standard for Class A and Class B TAWS may be the applicable European technical standards order (ETSO) issued by the Agency or equivalent.

NCC.IDE.A.140 Airborne collision avoidance system (ACAS)

Unless otherwise provided for by Regulation (EU) No 1332/2011, turbine-powered aeroplanes with an MCTOM of more than 5700 kg or an MOPSC of more than 19 shall be equipped with ACAS II.

NCC.IDE.A.145 Airborne weather detecting equipment

The following aeroplanes shall be equipped with airborne weather detecting equipment when operated at night or in IMC in areas where thunderstorms or other potentially hazardous weather conditions, regarded as detectable with airborne weather detecting equipment, may be expected to exist along the route:

- (a) pressurised aeroplanes;
- (b) non-pressurised aeroplanes with an MCTOM of more than 5 700 kg; and
- (c) non-pressurised aeroplanes with an MOPSC of more than nine.

AMC1 NCC.IDE.A.145 Airborne weather detecting equipment**GENERAL**

The airborne weather detecting equipment should be an airborne weather radar, except for propeller-driven pressurised aeroplanes with an MCTOM not more than 5 700 kg and an MOPSC of not more than nine, for which other equipment capable of detecting thunderstorms and other potentially hazardous weather conditions, regarded as detectable with airborne weather radar equipment, are also acceptable.

NCC.IDE.A.150 Additional equipment for operations in icing conditions at night

- (a) Aeroplanes operated in expected or actual icing conditions at night shall be equipped with a means to illuminate or detect the formation of ice.
- (b) The means to illuminate the formation of ice shall not cause glare or reflection that would handicap flight crew members in the performance of their duties.

NCC.IDE.A.155 Flight crew interphone system

Aeroplanes operated by more than one flight crew member shall be equipped with a flight crew interphone system, including headsets and microphones for use by all flight crew members.

AMC1 NCC.IDE.A.155 Flight crew interphone system

TYPE OF FLIGHT CREW INTERPHONE

The flight crew interphone system should not be of a handheld type.

NCC.IDE.A.160 Cockpit voice recorder

- (a) The following aeroplanes shall be equipped with a CVR:
- (1) aeroplanes with an MCTOM of more than 27 000 kg and first issued with an individual CofA on or after 1 January 2016; and
 - (2) aeroplanes with an MCTOM of more than 2 250 kg:
 - (i) certified for operation with a minimum crew of at least two pilots;
 - (ii) equipped with turbojet engine(s) or more than one turboprop engine; and
 - (iii) for which a type certificate is first issued on or after 1 January 2016.
- (b) The CVR shall be capable of retaining data recorded during at least:
- (1) the preceding 25 hours for aeroplanes with an MCTOM of more than 27 000 kg and first issued with an individual CofA on or after 1 January 2021; or
 - (2) the preceding 2 hours in all other cases.
- (c) The CVR shall record with reference to a timescale:
- (1) voice communications transmitted from or received in the flight crew compartment by radio;
 - (2) flight crew members' voice communications using the interphone system and the public address system, if installed;
 - (3) the aural environment of the flight crew compartment, including, without interruption, the audio signals received from each boom and mask microphone in use; and
 - (4) voice or audio signals identifying navigation or approach aids introduced into a headset or speaker.
- (d) The CVR shall start automatically to record prior to the aeroplane moving under its own power and shall continue to record until the termination of the flight when the aeroplane is no longer capable of moving under its own power.
- (e) In addition to (d), depending on the availability of electrical power, the CVR shall start to record as early as possible during the cockpit checks prior to engine start at the beginning of the flight until the cockpit checks immediately following engine shutdown at the end of the flight.
- (f) If the CVR is not deployable, it shall have a device to assist in locating it under water. By 1 January 2020 at the latest, this device shall have a minimum underwater transmission time of 90 days. If the CVR is deployable, it shall have an automatic emergency locator transmitter.

AMC1 NCC.IDE.A.160 Cockpit voice recorder

GENERAL

- (a) The operational performance requirements for cockpit voice recorders (CVRs) should be those laid down in the European Organisation for Civil Aviation Equipment (EUROCAE) Document ED-112 (Minimum Operational Performance Specification for Crash Protected Airborne Recorder Systems), dated March 2003, including Amendments n°1 and 2, or any later equivalent standard produced by EUROCAE.
- (b) The operational performance requirements for equipment dedicated to the CVR should be those laid down in the European Organisation for Civil Aviation Equipment (EUROCAE) Document ED-56A (Minimum Operational Performance Requirements For Cockpit Voice Recorder Systems) dated

December 1993, or EUROCAE Document ED-112 (Minimum Operational Performance Specification for Crash Protected Airborne Recorder Systems) dated March 2003, including Amendments No°1 and No°2, or any later equivalent standard produced by EUROCAE.

NCC.IDE.A.165 Flight data recorder

- (a) Aeroplanes with an MCTOM of more than 5 700 kg and first issued with an individual CofA on or after 1 January 2016 shall be equipped with an FDR that uses a digital method of recording and storing data and for which a method of readily retrieving that data from the storage medium is available.
- (b) The FDR shall record the parameters required to determine accurately the aeroplane flight path, speed, attitude, engine power, configuration and operation and be capable of retaining data recorded during at least the preceding 25 hours.
- (c) Data shall be obtained from aeroplane sources that enable accurate correlation with information displayed to the flight crew.
- (d) The FDR shall start automatically to record the data prior to the aeroplane being capable of moving under its own power and shall stop automatically after the aeroplane is incapable of moving under its own power.
- (e) If the FDR is not deployable, it shall have a device to assist in locating it under water. By 1 January 2020 at the latest, this device shall have a minimum underwater transmission time of 90 days. If the FDR is deployable, it shall have an automatic emergency locator transmitter.

AMC1 NCC.IDE.A.165 Flight data recorder**OPERATIONAL PERFORMANCE REQUIREMENTS FOR AEROPLANES FIRST ISSUED WITH AN INDIVIDUAL CofA ON OR AFTER 1 JANUARY 2016 AND BEFORE 1 JANUARY 2023**

- (a) The operational performance requirements for flight data recorders (FDRs) should be those laid down in EUROCAE Document ED-112 (Minimum Operational Performance Specification for Crash Protected Airborne Recorder Systems) dated March 2003, including amendments n°1 and n°2, or any later equivalent standard produced by EUROCAE.
- (b) The flight data recorder should record, with reference to a timescale, the list of parameters in Table 1 and Table 2, as applicable.
- (c) The parameters to be recorded should meet the performance specifications (designated ranges, sampling intervals, accuracy limits and minimum resolution in read-out) as defined in the relevant tables of EUROCAE Document ED-112, dated March 2003, including amendments n°1 and 2, or any later equivalent standard produced by EUROCAE.

Table 1: All Aeroplanes

No*	Parameter
1a	Time; or
1b	Relative time count
1c	Global navigation satellite system (GNSS) time synchronisation
2	Pressure altitude
3	Indicated airspeed; or calibrated airspeed
4	Heading (primary flight crew reference) - when true or magnetic heading can be selected, the primary heading reference, a discrete indicating selection, should be recorded

No*	Parameter
5	Normal acceleration
6	Pitch attitude
7	Roll attitude
8	Manual radio transmission keying and CVR/FDR synchronisation reference.
9	Engine thrust/power:
9a	Parameters required to determine propulsive thrust/power on each engine
9b	Flight crew compartment thrust/power lever position (for aeroplanes with non-mechanically linked flight crew compartment — engine controls)
14	Total or outside air temperature
16	Longitudinal acceleration (body axis)
17	Lateral acceleration
18	Primary flight control surface and/or primary flight control pilot input (for aeroplanes with control systems in which movement of a control surface will back drive the pilot's control, 'or' applies. For aeroplanes with control systems in which movement of a control surface will not back drive the pilot's control, 'and' applies. For multiple or split surfaces, a suitable combination of inputs is acceptable instead of recording each surface separately. For aeroplanes that have a flight control break-away capability that allows either pilot to operate the controls independently, record both inputs):
18a	Pitch axis
18b	Roll axis
18c	Yaw axis
19	Pitch trim surface position
23	Marker beacon passage
24	Warnings — in addition to the master warning each 'red' warning (including smoke warnings from other compartments) should be recorded when the warning condition cannot be determined from other parameters or from the CVR
25	Each navigation receiver frequency selection
27	Air—ground status. Air—ground status (and a sensor of each landing gear if installed)

* The number in the left hand column reflects the serial number depicted in EUROCAE ED-112.

Table 2: Aeroplanes for which the data source for the parameter is either used by aeroplane systems or is available on the instrument panel for use by the flight crew to operate the aeroplane

No*	Parameter
10	Flaps
10a	Trailing edge flap position
10b	Flight crew compartment control selection
11	Slats
11a	Leading edge flap (slat) position
11b	Flight crew compartment control selection
12	Thrust reverse status
13	Ground spoiler and speed brake:
13a	Ground spoiler position
13b	Ground spoiler selection
13c	Speed brake position
13d	Speed brake selection
15	Autopilot, autothrottle, automatic flight control system (AFCS) mode and engagement status
20	Radio altitude. For auto-land/Category III operations, each radio altimeter should be recorded.
21	Vertical deviation — (the approach aid in use should be recorded. For auto-land/CAT III operations, each system should be recorded.):
21a	ILS/GPS/GLS glide path
21b	MLS elevation
21c	Integrated approach navigation (IAN)/integrated area navigation (IRNAV), vertical deviation
22	Horizontal deviation — (the approach aid in use should be recorded. For auto-land/CAT III operations, each system should be recorded. It is acceptable to arrange them so that at least one is recorded every second):
22a	ILS/GPS/GLS localiser
22b	MLS azimuth
22c	GNSS approach path/IRNAV lateral deviation
26	Distance measuring equipment (DME) 1 and 2 distances:
26a	Distance to runway threshold (GLS)

No*	Parameter
26b	Distance to missed approach - Point (IRNAV/IAN)
28	Ground proximity warning system (GPWS)/TAWS/ground collision avoidance system (GCAS) status:
28a	Selection of terrain display mode, including pop-up display status
28b	Terrain alerts, including cautions and warnings and advisories
28c	On/off switch position
29	Angle of attack
30	Low pressure warning (each system):
30a	Hydraulic pressure
30b	Pneumatic pressure
31	Ground speed
32	Landing gear:
32a	Landing gear position
32b	Gear selector position
33	Navigation data:
33a	Drift angle
33b	Wind speed
33c	Wind direction
33d	Latitude
33e	Longitude
33f	GNSS augmentation in use
34	Brakes:
34a	Left and right brake pressure
34b	Left and right brake pedal position
35	Additional engine parameters (if not already recorded in parameter 9 of Table 1 of AMC1 NCC.IDE.A.165 and if the aeroplane is equipped with a suitable data source):
35a	Engine pressure ratio (EPR)
35b	N ₁
35c	Indicated vibration level
35d	N ₂

No*	Parameter
35e	Exhaust gas temperature (EGT)
35f	Fuel flow
35g	Fuel cut-off lever position
35h	N ₃
36	Traffic alert and collision avoidance system (TCAS)/ACAS — a suitable combination of discrettes should be recorded to determine the status of the system:
36a	Combined control
36b	Vertical control
36c	Up advisory
36d	Down advisory
36e	Sensitivity level
37	Wind shear warning
38	Selected barometric setting:
38a	Pilot
38b	Co-pilot
39	Selected altitude (all pilot selectable modes of operation) — to be recorded for the aeroplane where the parameter is displayed electronically
40	Selected speed (all pilot selectable modes of operation) — to be recorded for the aeroplane where the parameter is displayed electronically
41	Selected Mach (all pilot selectable modes of operation) — to be recorded for the aeroplane where the parameter is displayed electronically
42	Selected vertical speed (all pilot selectable modes of operation) — to be recorded for the aeroplane where the parameter is displayed electronically
43	Selected heading (all pilot selectable modes of operation) — to be recorded for the aeroplane where the parameter is displayed electronically
44	Selected flight path (All pilot selectable modes of operation) - to be recorded for the aeroplane where the parameter is displayed electronically:
44a	Course/desired track (DSTRK)
44b	Path angle
44c	Coordinates of final approach path (IRNAV/IAN)
45	Selected decision height - to be recorded for the aeroplane where the parameter is displayed electronically

No*	Parameter
46	Electronic flight instrument system (EFIS) display format:
46a	Pilot
46b	Co-pilot
47	Multi-function/engine/alerts display format
48	AC electrical bus status — each bus
49	DC electrical bus status — each bus
50	Engine bleed valve position
51	Auxiliary power unit (APU) bleed valve position
52	Computer failure (all critical flight and engine control systems)
53	Engine thrust command
54	Engine thrust target
55	Computed centre of gravity (CG)
56	Fuel quantity in CG trim tank
57	Head-up display in use
58	Para visual display on
59	Operational stall protection, stick shaker and pusher activation
60	Primary navigation system reference:
60a	GNSS
60b	Inertial navigational system (INS)
60c	VHF omnidirectional radio range (VOR)/DME
60d	MLS
60e	Loran C
60f	ILS
61	Ice detection
62	Engine warning — each engine vibration
63	Engine warning — each engine over temperature
64	Engine warning — each engine oil pressure low

No*	Parameter
65	Engine warning — each engine over speed
66	Yaw trim surface position
67	Roll trim surface position
68	Yaw or sideslip angle
69	De-icing and/or anti-icing systems selection
70	Hydraulic pressure — each system
71	Loss of cabin pressure
72	Trim control input position in the flight crew compartment, pitch — when mechanical means for control inputs are not available, displayed trim position or trim command should be recorded
73	Trim control input position in the flight crew compartment, roll — when mechanical means for control inputs are not available, displayed trim position or trim command should be recorded
74	Trim control input position in the flight crew compartment, yaw — when mechanical means for control inputs are not available, displayed trim position or trim command should be recorded
75	All flight control input forces (for fly-by-wire flight control systems, where control surface position is a function of the displacement of the control input device only, it is not necessary to record this parameter):
75a	Control wheel
75b	Control column
75c	Rudder pedal
76	Event marker
77	Date
78	Actual navigation performance (ANP) or estimate of position error (EPE) or estimate of position uncertainty (EPU)

* The number in the left hand column reflects the serial number depicted in EUROCAE ED-112.

AMC2 NCC.IDE.A.165 Flight data recorder**OPERATIONAL PERFORMANCE REQUIREMENTS FOR AEROPLANES FIRST ISSUED WITH AN INDIVIDUAL CofA ON OR AFTER 1 JANUARY 2023**

- (a) The operational performance requirements for flight data recorders (FDRs) should be those laid down in EUROCAE Document 112A (Minimum Operational Performance Specification for Crash Protected Airborne Recorder Systems) dated September 2013, or any later equivalent standard produced by EUROCAE.
- (b) The FDR should, with reference to a timescale, record:
- (1) the list of parameters in Table 1 below;
 - (2) the additional parameters listed in Table 2 below, when the information data source for the parameter is used by aeroplane systems or is available on the instrument panel for use by the flight crew to operate the aeroplane; and
 - (3) any dedicated parameters related to novel or unique design or operational characteristics of the aeroplane as determined by the Agency.
- (c) The parameters to be recorded should meet the performance specifications (range, sampling intervals, accuracy limits and resolution in read-out) as defined in the relevant tables of EUROCAE Document 112A, or any later equivalent standard produced by EUROCAE.

Table 1: FDR — All aeroplanes

No*	Parameter
1a	Time; or
1b	Relative time count
1c	Global navigation satellite system (GNSS) time synchronisation
2	Pressure altitude (including altitude values displayed on each flight crew member's primary flight display)
3	Indicated airspeed or calibrated airspeed (including values of indicated airspeed or calibrated airspeed displayed on each flight crew member's primary flight display)
4	Heading (primary flight crew reference) — when true or magnetic heading can be selected, the primary heading reference, a discrete indicating selection should be recorded.
5	Normal acceleration
6	Pitch attitude — pitch attitude values displayed on each flight crew member's primary flight display should be recorded, unless the aeroplane is type certified before 1 January 2023 and recording the values displayed at the captain position or the first officer position would require extensive modification.
7	Roll attitude — roll attitude values displayed on each flight crew member's primary flight display should be recorded, unless the aeroplane is type certified before 1 January 2023 and recording the values displayed at the captain position or the first officer position would require extensive modification.

No*	Parameter
8	Manual radio transmission keying and CVR/FDR synchronisation reference
9	Engine thrust/power:
9a	Parameters required to determine propulsive thrust/power on each engine, in both normal and reverse thrust
9b	Flight crew compartment thrust/power lever position (for aeroplanes with non-mechanically linked engine controls in the flight crew compartment)
14	Total or outside air temperature
16	Longitudinal acceleration (body axis)
17	Lateral acceleration
18	Primary flight control surface and/or primary flight control pilot input (For aeroplanes with control systems in which the movement of a control surface will back drive the pilot's control, 'or' applies. For aeroplanes with control systems in which the movement of a control surface will not back drive the pilot's control, 'and' applies. For multiple or split surfaces, a suitable combination of inputs is acceptable in lieu of recording each surface separately. For aeroplanes that have a flight control break-away capability that allows either pilot to operate the controls independently, record both inputs):
18a	Pitch axis
18b	Roll axis
18c	Yaw axis
19	Pitch trim surface position
23	Marker beacon passage
24	Warnings — in addition to the master warning, each 'red' warning that cannot be determined from other parameters or from the CVR and each smoke warning from other compartments should be recorded.
25	Each navigation receiver frequency selection
27	Air-ground status. Air-ground status and a sensor of each landing gear if installed

* The number in the left-hand column reflects the serial number depicted in EUROCAE 112A.

Table 2: FDR — Aeroplanes for which the data source for the parameter is either used by the aeroplane systems or is available on the instrument panel for use by the flight crew to operate the aeroplane

No*	Parameter
10	Flaps:
10a	Trailing edge flap position
10b	Flight crew compartment control selection
11	Slats:
11a	Leading edge flap (slat) position
11b	Flight crew compartment control selection
12	Thrust reverse status
13	Ground spoiler and speed brake:
13a	Ground spoiler position
13b	Ground spoiler selection
13c	Speed brake position
13d	Speed brake selection
15	Autopilot, autothrottle and automatic flight control system (AFCS): mode and engagement status (showing which systems are engaged and which primary modes are controlling the flight path and speed of the aircraft)
20	Radio altitude. For auto-land/category III operations, each radio altimeter should be recorded.
21	Vertical deviation — the approach aid in use should be recorded. For auto-land/category III operations, each system should be recorded:
21a	ILS/GPS/GLS glide path
21b	MLS elevation
21c	Integrated approach navigation (IAN) /Integrated Area Navigation, vertical deviation
22	Horizontal deviation — the approach aid in use should be recorded. For auto-land/category III operations, each system should be recorded:
22a	ILS/GPS/GLS localiser
22b	MLS azimuth
22c	GNSS approach path/IRNAV lateral deviation
26	Distance measuring equipment (DME) 1 and 2 distances:
26a	Distance to runway threshold (GLS)
26b	Distance to missed approach point (IRNAV/IAN)
28	Ground proximity warning system (GPWS)/terrain awareness warning system (TAWS)/ground

No*	Parameter
28a	collision avoidance system (GCAS) status — a suitable combination of discrettes unless recorder capacity is limited in which case a single discrete for all modes is acceptable: Selection of terrain display mode, including pop-up display status
28b	Terrain alerts, including cautions and warnings and advisories
28c	On/off switch position
29	Angle of attack
30	Low pressure warning (each system):
30a	Hydraulic pressure
30b	Pneumatic pressure
31	Ground speed
32	Landing gear:
32a	Landing gear position
32b	Gear selector position
33	Navigation data:
33a	Drift angle
33b	Wind speed
33c	Wind direction
33d	Latitude
33e	Longitude
33f	GNSS augmentation in use
34	Brakes:
34a	Left and right brake pressure
34b	Left and right brake pedal position
35	Additional engine parameters (if not already recorded in parameter 9 of Table 1, and if the aeroplane is equipped with a suitable data source):
35a	Engine pressure ratio (EPR)
35b	N1
35c	Indicated vibration level
35d	N2
35e	Exhaust gas temperature (EGT)
35f	Fuel flow
35g	Fuel cut-off lever position

No*	Parameter
35h	N3
35i	Engine fuel metering valve position (or equivalent parameter from the system that directly controls the flow of fuel into the engine) — for aeroplanes type certified before 1 January 2023, to be recorded only if this does not require extensive modification.
36	Traffic alert and collision avoidance system (TCAS)/airborne collision avoidance system (ACAS) — a suitable combination of discrettes should be recorded to determine the status of the system:
36a	Combined control
36b	Vertical control
36c	Up advisory
36d	Down advisory
36e	Sensitivity level
37	Wind shear warning
38	Selected barometric setting — to be recorded for the aeroplane where the parameter is displayed electronically:
38a	Pilot selected barometric setting
38b	Co-pilot selected barometric setting
39	Selected altitude (all pilot selectable modes of operation) — to be recorded for the aeroplane where the parameter is displayed electronically
40	Selected speed (all pilot selectable modes of operation) — to be recorded for the aeroplane where the parameter is displayed electronically
41	Selected Mach (all pilot selectable modes of operation) — to be recorded for the aeroplane where the parameter is displayed electronically
42	Selected vertical speed (all pilot selectable modes of operation) — to be recorded for the aeroplane where the parameter is displayed electronically
43	Selected heading (all pilot selectable modes of operation) — to be recorded for the aeroplane where the parameter is displayed electronically
44	Selected flight path (all pilot selectable modes of operation) — to be recorded for the aeroplane where the parameter is displayed electronically:
44a	Course/desired track (DSTRK)
44b	Path angle
44c	Coordinates of final approach path (IRNAV/IAN)
45	Selected decision height — to be recorded for the aeroplane where the parameter is displayed electronically

No*	Parameter
46 46a 46b	Electronic flight instrument system (EFIS) display format, showing the display system status: Pilot Co-pilot
47	Multi-function/engine/alerts display format, showing the display system status
48	Alternating current (AC) electrical bus status — each bus
49	Direct current (DC) electrical bus status — each bus
50	Engine bleed valve(s) position
51	Auxiliary power unit (APU) bleed valve(s) position
52	Computer failure — all critical flight and engine control systems
53	Engine thrust command
54	Engine thrust target
55	Computed centre of gravity (CG)
56	Fuel quantity in CG trim tank
57	Head-up display in use
58	Paravisual display on
59	Operational stall protection, stick shaker and pusher activation
60 60a 60b 60c 60d 60e 60f	Primary navigation system reference: GNSS Inertial navigational system (INS) VHF omnidirectional radio range (VOR)/distance measuring equipment (DME) MLS Loran C ILS
61	Ice detection
62	Engine warning — each engine vibration
63	Engine warning — each engine over temperature
64	Engine warning — each engine oil pressure low

No*	Parameter
65	Engine warning — each engine overspeed
66	Yaw trim surface position
67	Roll trim surface position
68	Yaw or sideslip angle
69	De-icing and/or anti-icing systems selection
70	Hydraulic pressure — each system
71	Loss of cabin pressure
72	Trim control input position in the flight crew compartment, pitch — when mechanical means for control inputs are not available, displayed trim position or trim command should be recorded.
73	Trim control input position in the flight crew compartment, roll — when mechanical means for control inputs are not available, displayed trim position or trim command should be recorded.
74	Trim control input position in the flight crew compartment, yaw — when mechanical means for control inputs are not available, displayed trim position or trim command should be recorded.
75	All flight control input forces (for fly-by-wire flight control systems, where control surface position is a function of the displacement of the control input device only, it is not necessary to record this parameter):
75a	Control wheel input forces
75b	Control column input forces
75c	Rudder pedal input forces
76	Event marker
77	Date
78	Actual navigation performance (ANP) or estimate of position error (EPE) or estimate of position uncertainty (EPU)
79	Cabin pressure altitude — for aeroplanes type certified before 1 January 2023, to be recorded only if this does not require extensive modification.
80	Aeroplane computed weight — for aeroplanes type certified before 1 January 2023, to be recorded only if this does not require extensive modification.
81	Flight director command:
81a	Left flight director pitch command — for aeroplanes type certified before 1 January 2023, to be recorded only if this does not require extensive modification.

No*	Parameter
81b	Left flight director roll command — for aeroplanes type certified before 1 January 2023, to be recorded only if this does not require extensive modification.
81c	Right flight director pitch command — for aeroplanes type certified before 1 January 2023, to be recorded only if this does not require extensive modification.
81d	Right flight director roll command — for aeroplanes type certified before 1 January 2023, to be recorded only if this does not require extensive modification.
82	Vertical speed — for aeroplanes type certified before 1 January 2023, to be recorded only if this does not require extensive modification.

* The number in the left-hand column reflects the serial number depicted in EUROCAE Document 112A.

NCC.IDE.A.170 Data link recording

- (a) Aeroplanes first issued with an individual CofA on or after 1 January 2016 that have the capability to operate data link communications and are required to be equipped with a CVR shall record on a recorder, where applicable:
- (1) data link communication messages related to ATS communications to and from the aeroplane, including messages applying to the following applications:
 - (i) data link initiation;
 - (ii) controller–pilot communication;
 - (iii) addressed surveillance;
 - (iv) flight information;
 - (v) as far as is practicable, given the architecture of the system, aircraft broadcast surveillance;
 - (vi) as far as is practicable, given the architecture of the system, aircraft operational control data; and
 - (vii) as far as is practicable, given the architecture of the system, graphics;
 - (2) information that enables correlation to any associated records related to data link communications and stored separately from the aeroplane; and
 - (3) information on the time and priority of data link communications messages, taking into account the system’s architecture.
- (b) The recorder shall use a digital method of recording and storing data and information and a method for readily retrieving that data. The recording method shall allow the data to match the data recorded on the ground.
- (c) The recorder shall be capable of retaining data recorded for at least the same duration as set out for CVRs in NCC.IDE.A.160.
- (d) If the recorder is not deployable, it shall have a device to assist in locating it under water. By 1 January 2020 at the latest, this device shall have a minimum underwater transmission time of 90 days. If the recorder is deployable, it shall have an automatic emergency locator transmitter.
- (e) The requirements applicable to the start and stop logic of the recorder are the same as the requirements applicable to the start and stop logic of the CVR contained in NCC.IDE.A.160(d) and (e).

AMC1 NCC.IDE.A.170 Data link recording

GENERAL

- (a) As a means of compliance with NCC.IDE.A.170 (a) the recorder on which the data link messages are recorded may be:
- (1) the CVR;
 - (2) the FDR;
 - (3) a combination recorder when NCC.IDE.A.175 is applicable; or
 - (4) a dedicated flight recorder. In that case, the operational performance requirements for this recorder should be those laid down in EUROCAE Document ED-112 (Minimum Operational Performance Specification for Crash Protected Airborne Recorder Systems), dated March

2003, including amendments No 1 and 2, or any later equivalent standard produced by EUROCAE.

- (b) As a means of compliance with NCC.IDE.A.170 (a)(2) the operator should enable correlation by providing information that allows an accident investigator to understand what data was provided to the aircraft and, when the provider identification is contained in the message, by which provider.
- (c) The timing information associated with the data link communications messages required to be recorded by NCC.IDE.A.170 (a)(3) should be capable of being determined from the airborne-based recordings. This timing information should include at least the following:
- (1) the time each message was generated;
 - (2) the time any message was available to be displayed by the flight crew;
 - (3) the time each message was actually displayed or recalled from a queue; and
 - (4) the time of each status change.
- (d) The message priority should be recorded when it is defined by the protocol of the data link communication message being recorded.
- (e) The expression ‘taking into account the system’s architecture’, in NCC.IDE.A.170 (a)(3), means that the recording of the specified information may be omitted if the existing source systems involved would require a major upgrade. The following should be considered:
- (1) the extent of the modification required;
 - (2) the down-time period; and
 - (3) equipment software development.
- (f) Data link communications messages that support the applications in Table 1 below should be recorded.
- (g) Further details on the recording requirements can be found in the recording requirement matrix in Appendix D.2 of EUROCAE Document ED-93 (Minimum Aviation System Performance Specification for CNS/ATM Recorder Systems), dated November 1998.

Table 1: Data link recording

Item No.	Application Type	Application Description	Required Recording Content
1	Data link initiation	This includes any application used to log on to, or initiate, a data link service. In future air navigation system (FANS)-1/A and air traffic navigation (ATN), these are ATS facilities notification (AFN) and context management (CM), respectively.	C
2	Controller/pilot communication	This includes any application used to exchange requests, clearances, instructions and reports between the flight crew and controllers on the ground. In FANS-1/A and ATN, this includes the controller pilot data link communications (CPDLC) application.	C

Item No.	Application Type	Application Description	Required Recording Content
		It also includes applications used for the exchange of oceanic clearances (OCL) and departure clearances (DCL), as well as data link delivery of taxi clearances.	
3	Addressed surveillance	This includes any surveillance application in which the ground sets up contracts for delivery of surveillance data. In FANS-1/A and ATN, this includes the automatic dependent surveillance-contract (ADS-C) application.	C, F2
4	Flight information	This includes any application used for delivery of flight information data to specific aeroplanes. This includes for example digital automatic terminal information service (D ATIS), data link operational terminal information service (D OTIS), digital weather information services (data link-meteorological aerodrome or aeronautical report (D-METAR) or terminal weather information for pilots (TWIP)), data link flight information service (D-FIS), and Notice to Airmen (electronic NOTAM) delivery.	C
5	Broadcast surveillance	This includes elementary and enhanced surveillance systems, as well as automatic dependent surveillance-broadcast (ADS-B) output data.	M*, F2
6	Aeronautical operational control (AOC) data	This includes any application transmitting or receiving data used for AOC purposes (in accordance with the ICAO definition of AOC). Such systems may also process aeronautical administrative communication (AAC) messages, but there is no requirement to record AAC messages	M*
7	Graphics	This includes any application receiving graphical data to be used for operational purposes (i.e. excluding applications that are receiving such things as updates to manuals).	M* F1

GM1 NCC.IDE.A.170 Data link recording

GENERAL

- (a) The letters and expressions in Table 1 of AMC1 NCC.IDE.A.170 have the following meaning:
- (1) C: complete contents recorded.
 - (2) M: information that enables correlation with any associated records stored separately from the aeroplane.
 - (3) *: applications that are to be recorded only as far as is practicable, given the architecture of the system.
 - (4) F1: graphics applications may be considered as AOC messages when they are part of a data link communications application service run on an individual basis by the operator itself in the framework of the operational control.
 - (5) F2: where parametric data sent by the aeroplane, such as Mode S, is reported within the message, it should be recorded unless data from the same source is recorded on the FDR.
- (b) The definitions of the applications type in Table 1 of AMC1 NCC.IDE.A.170 are described in Table 1 below.

Table 1: Definitions of the applications type

Item No.	Application Type	Messages	Comments
1	CM		CM is an ATN service
2	AFN		AFN is a FANS 1/A service
3	CPDLC		All implemented up and downlink messages to be recorded
4	ADS-C	ADS-C reports	All contract requests and reports recorded
		Position reports	Only used within FANS 1/A. Mainly used in oceanic and remote areas.
5	ADS-B	Surveillance data	Information that enables correlation with any associated records stored separately from the aeroplane.
6	D-FIS		D-FIS is an ATN service. All implemented up and downlink messages to be recorded
7	TWIP	TWIP messages	Terminal weather information for pilots
8	D-ATIS	ATIS messages	Refer to EUROCAE ED-89A, dated December 2003: Data Link Application System Document (DLASD) for the 'ATIS' data link service

Item No.	Application Type	Messages	Comments
9	OCL	OCL messages	Refer to EUROCAE ED-106A, dated March 2004: Data Link Application System Document (DLASD) for 'Oceanic Clearance' (OCL) data link service
10	DCL	DCL messages	Refer to EUROCAE ED-85A, dated December 2005: Data Link Application System Document (DLASD) for 'Departure Clearance' data link service
11	Graphics	Weather maps & other graphics	Graphics exchanged in the framework of procedures within the operational control, as specified in Part-ORO. Information that enables correlation with any associated records stored separately from the aeroplane.
12	AOC	Aeronautical operational control messages	Messages exchanged in the framework of procedures within the operational control, as specified in Part-ORO. Information that enables correlation with any associated records stored separately from the aeroplane. Definition in EUROCAE ED-112, dated March 2003.
13	Surveillance	Downlinked aircraft parameters (DAP)	As defined in ICAO Annex 10 Volume IV (Surveillance systems and ACAS).

AAC	aeronautical administrative communications
ADS-B	automatic dependent surveillance - broadcast
ADS-C	automatic dependent surveillance – contract
AFN	aircraft flight notification
AOC	aeronautical operational control
ATIS	automatic terminal information service
ATSC	air traffic service communication
CAP	controller access parameters
CPDLC	controller pilot data link communications
CM	configuration/context management
D-ATIS	digital ATIS
D-FIS	data link flight information service

D-METAR	data link meteorological airport report
DCL	departure clearance
FANS	Future Air Navigation System
FLIPCY	flight plan consistency
OCL	oceanic clearance
SAP	system access parameters
TWIP	terminal weather information for pilots

GM1 NCC.IDE.A.170(a) Data link recording

APPLICABILITY OF THE DATA LINK RECORDING REQUIREMENT

- (a) If it is certain that the aeroplane cannot use data link communication messages for ATS communications corresponding to any application designated by NCC.IDE.A.170(a)(1), then the data link recording requirement does not apply.
- (b) Examples where the aeroplane cannot use data link communication messages for ATS communications include but are not limited to the cases where:
 - (1) the aeroplane data link communication capability is disabled permanently and in a way that it cannot be enabled again during the flight;
 - (2) data link communications are not used to support air traffic service (ATS) in the area of operation of the aeroplane; and
 - (3) the aeroplane data link communication equipment cannot communicate with the equipment used by ATS in the area of operation of the aeroplane.

NCC.IDE.A.175 Flight data and cockpit voice combination recorder

Compliance with CVR requirements and FDR requirements may be achieved by:

- (a) one flight data and cockpit voice combination recorder if the aeroplane has to be equipped with a CVR or an FDR; or
- (b) two flight data and cockpit voice combination recorders if the aeroplane has to be equipped with a CVR and an FDR.

AMC1 NCC.IDE.A.175 Flight data and cockpit voice combination recorder

GENERAL

When two flight data and cockpit voice combination recorders are installed, one should be located near the flight crew compartment in order to minimise the risk of data loss due to a failure of the wiring that gathers data to the recorder. The other should be located at the rear section of the aeroplane in order to minimise the risk of data loss due to recorder damage in the case of a crash.

GM1 NCC.IDE.A.175 Flight data and cockpit voice combination recorder

GENERAL

- (a) A flight data and cockpit voice combination recorder is a flight recorder that records:
 - (1) all voice communications and the aural environment required by NCC.IDE.A.160; and
 - (2) all parameters required by NCC.IDE.A.165,with the same specifications required by NCC.IDE.A.160 and NCC.IDE.A.165.
- (b) In addition, a flight data and cockpit voice combination recorder may record data link communication messages and related information required by NCC.IDE.A.170.

NCC.IDE.A.180 Seats, seat safety belts, restraint systems and child restraint devices

- (a) Aeroplanes shall be equipped with:
- (1) a seat or berth for each person on board who is aged 24 months or more;
 - (2) a seat belt on each passenger seat and restraining belts for each berth;
 - (3) a child restraint device (CRD) for each person on board younger than 24 months;
 - (4) a seat belt with upper torso restraint system incorporating a device that will automatically restrain the occupant's torso in the event of rapid deceleration:
 - (i) on each flight crew seat and on any seat alongside a pilot's seat; and
 - (ii) on each observer's seat located in the flight crew compartment;and
 - (5) a seat belt with upper torso restraint system on the seats for the minimum required cabin crew, in the case of aeroplanes first issued with an individual CofA after 31 December 1980.
- (b) A seat belt with upper torso restraint system shall have:
- (1) a single point release;
 - (2) on the seats for the minimum required cabin crew, two shoulder straps and a seat belt that may be used independently; and
 - (3) on flight crew seats and on any seat alongside a pilot's seat:
 - (i) two shoulder straps and a seat belt that may be used independently; or
 - (ii) a diagonal shoulder strap and a seat belt that may be used independently for the following aeroplanes:
 - (A) aeroplanes with an MCTOM of less than 5 700 kg and with an MOPSC of less than nine that are compliant with the emergency landing dynamic conditions defined in the applicable certification specification;
 - (B) aeroplanes with an MCTOM of less than 5 700 kg and with an MOPSC of less than nine that are not compliant with the emergency landing dynamic conditions defined in the applicable certification specification and having an individual CofA first issued before 25 August 2016.

AMC1 NCC.IDE.A.180 Seats, seat safety belts, restraint systems and child restraint devices

CHILD RESTRAINT DEVICES (CRDS)

- (a) A CRD is considered to be acceptable if:
- (1) it is a 'supplementary loop' belt manufactured with the same techniques and the same materials as the approved safety belts; or
 - (2) it complies with (b).
- (b) Provided the CRD can be installed properly on the respective aircraft seat, the following CRDs are considered acceptable:
- (1) CRDs approved for use in aircraft by a competent authority on the basis of a technical standard and marked accordingly.
 - (2) CRDs approved for use in motor vehicles according to the UN standard ECE R 44, -03 or later series of amendments.

- (3) CRDs approved for use in motor vehicles and aircraft according to Canadian CMVSS 213/213.1.
 - (4) CRDs approved for use in motor vehicles and aircraft according to US FMVSS No 213 and manufactured to these standards on or after February 26, 1985. US approved CRDs manufactured after this date should bear the following labels in red letters:
 - (i) 'THIS CHILD RESTRAINT SYSTEM CONFORMS TO ALL APPLICABLE FEDERAL MOTOR VEHICLE SAFETY STANDARDS'; and
 - (ii) 'THIS RESTRAINT IS CERTIFIED FOR USE IN MOTOR VEHICLES AND AIRCRAFT';
 - (5) CRDs qualified for use in aircraft according to the German 'Qualification Procedure for Child Restraint Systems for Use in Aircraft' (TÜV Doc. TÜV/958-01/2001); and
 - (6) Devices approved for use in cars, manufactured and tested to standards equivalent to those listed above. The device should be marked with an associated qualification sign, which shows the name of the qualification organisation and a specific identification number, related to the associated qualification project. The qualifying organisation should be a competent and independent organisation that is acceptable to the competent authority.
- (c) Location
- (1) Forward facing CRDs may be installed on both forward and rearward facing passenger seats but only when fitted in the same direction as the passenger seat on which they are positioned. Rearward facing CRDs should only be installed on forward facing passenger seats. A CRD may not be installed within the radius of action of an airbag, unless it is obvious that the airbag is de-activated or it can be demonstrated that there is no negative impact from the airbag.
 - (2) An infant in a CRD should be located as near to a floor level exit as feasible.
 - (3) An infant in a CRD should not hinder evacuation for any passenger.
 - (4) An infant in a CRD should neither be located in the row (where rows are existing) leading to an emergency exit nor located in a row immediately forward or aft of an emergency exit. A window passenger seat is the preferred location. An aisle passenger seat or a cross aisle passenger seat that forms part of the evacuation route to exits is not recommended. Other locations may be acceptable provided the access of neighbour passengers to the nearest aisle is not obstructed by the CRD.
 - (5) In general, only one CRD per row segment is recommended. More than one CRD per row segment is allowed if the infants are from the same family or travelling group provided the infants are accompanied by a responsible adult sitting next to them.
 - (6) A row segment is the fraction of a row separated by two aisles or by one aisle and the aeroplane fuselage.
- (d) Installation
- (1) CRDs should only be installed on a suitable aircraft seat with the type of connecting device they are approved or qualified for. E.g., CRDs to be connected by a three point harness only (most rearward facing baby CRDs currently available) should not be attached to an aeroplane seat with a lap belt only; a CRD designed to be attached to a vehicle seat by means of rigid bar lower anchorages (ISO-FIX or US equivalent) only, should only be used on aeroplane seats that are equipped with such connecting devices and should not be attached by the aeroplane seat lap belt. The method of connecting should be the one shown in the manufacturer's instructions provided with each CRD.

- (2) All safety and installation instructions should be followed carefully by the responsible adult accompanying the infant. Crew members should prohibit the use of any inadequately installed CRD or not qualified seat.
 - (3) If a forward facing CRD with a rigid backrest is to be fastened by a lap belt, the restraint device should be fastened when the backrest of the passenger seat on which it rests is in a reclined position. Thereafter, the backrest is to be positioned upright. This procedure ensures better tightening of the CRD on the aircraft seat if the aircraft seat is reclinable.
 - (4) The buckle of the adult safety belt should be easily accessible for both opening and closing, and should be in line with the seat belt halves (not canted) after tightening.
 - (5) Forward facing restraint devices with an integral harness must not be installed such that the adult safety belt is secured over the infant.
- (e) Operation
- (1) Each CRD should remain secured to a passenger seat during all phases of flight, unless it is properly stowed when not in use.
 - (2) Where a CRD is adjustable in recline, it should be in an upright position for all occasions when passenger restraint devices are required.

AMC2 NCC.IDE.A.180 Seats, seat safety belts, restraint systems and child restraint devices

UPPER TORSO RESTRAINT SYSTEM

- (a) A restraint system including a seat belt, two shoulder straps and additional straps is deemed to be compliant with the requirement for restraint systems with two shoulder straps.
- (b) An upper torso restraint system which restrains permanently the torso of the occupant is deemed to be compliant with the requirement for an upper torso restraint system incorporating a device that will automatically restrain the occupant's torso in the event of rapid deceleration.
- (c) The use of the upper torso restraint independently from the use of the seat belt is intended as an option for the comfort of the occupant of the seat in those phases of flight where only the seat belt is required to be fastened. A restraint system including a seat belt and an upper torso restraint that both remain permanently fastened is also acceptable.

SEAT BELT

A seat belt with a diagonal shoulder strap (three anchorage points) is deemed to be compliant with the requirement for a seat belt (two anchorage points).

AMC3 NCC.IDE.A.180 Seats, seat safety belts, restraint systems and child restraint devices

SEATS FOR MINIMUM REQUIRED CABIN CREW

- (a) Seats for the minimum required cabin crew members should be located near required floor level emergency exits, except if the emergency evacuation of passengers would be enhanced by seating cabin crew members elsewhere. In this case, other locations are acceptable.
- (b) Such seats should be forward or rearward facing within 15° of the longitudinal axis of the aeroplane.

GM1 NCC.IDE.A.180 Seats, seat safety belts, restraint systems and child restraint devices

EMERGENCY LANDING DYNAMIC CONDITIONS

Emergency landing dynamic conditions are defined in 23.562 of CS-23 or equivalent and in 25.562 of CS-25 or equivalent.

NCC.IDE.A.185 Fasten seat belt and no smoking signs

Aeroplanes in which not all passenger seats are visible from the flight crew seat(s) shall be equipped with a means of indicating to all passengers and cabin crew when seat belts shall be fastened and when smoking is not allowed.

NCC.IDE.A.190 First-aid kit

- (a) Aeroplanes shall be equipped with first-aid kits in accordance with Table 1.

Table 1

Number of first-aid kits required

Number of passenger seats installed	Number of first-aid kits required
0 – 100	1
101 – 200	2
201 – 300	3
301 – 400	4
401 – 500	5
501 or more	6

- (b) First-aid kits shall be:
- (1) readily accessible for use; and
 - (2) kept up-to-date.

AMC1 NCC.IDE.A.190 First-aid kit

CONTENT OF FIRST-AID KITS

- (a) First-aid kits should be equipped with appropriate and sufficient medications and instrumentation. However, these kits should be amended by the operator according to the characteristics of the operation (scope of operation, flight duration, number and demographics of passengers, etc.).
- (b) The following should be included in the FAKs:
- (1) Equipment:
 - (i) bandages (assorted sizes);
 - (ii) burns dressings (unspecified);
 - (iii) wound dressings (large and small);
 - (iv) adhesive dressings (assorted sizes);
 - (v) adhesive tape;
 - (vi) adhesive wound closures;

- (vii) safety pins;
 - (viii) safety scissors;
 - (ix) antiseptic wound cleaner;
 - (x) disposable resuscitation aid;
 - (xi) disposable gloves;
 - (xii) tweezers: splinter; and
 - (xiii) thermometers (non-mercury).
- (2) Medications:
- (i) simple analgesic (may include liquid form);
 - (ii) antiemetic;
 - (iii) nasal decongestant;
 - (iv) gastrointestinal antacid, in the case of aeroplanes carrying more than nine passengers;
 - (v) anti-diarrhoeal medication, in the case of aeroplanes carrying more than nine passengers; and
 - (vi) antihistamine.
- (3) Other:
- (i) a list of contents in at least two languages (English and one other). This should include information on the effects and side effects of medications carried;
 - (ii) first-aid handbook, current edition;
 - (iii) medical incident report form; and
 - (iv) biohazard disposal bags.
- (4) An eye irrigator, although not required to be carried in the FAK, should, where possible, be available for use on the ground.

AMC2 NCC.IDE.A.190 First-aid kit

MAINTENANCE OF FIRST-AID KITS

To be kept up to date first-aid kits should be:

- (a) inspected periodically to confirm, to the extent possible, that contents are maintained in the condition necessary for their intended use;
- (b) replenished at regular intervals, in accordance with instructions contained on their labels, or as circumstances warrant; and
- (c) replenished after use in-flight at the first opportunity where replacement items are available.

NCC.IDE.A.195 Supplemental oxygen — pressurised aeroplanes

- (a) Pressurised aeroplanes operated at flight altitudes for which the oxygen supply is required in accordance with (b) shall be equipped with oxygen storage and dispensing apparatus capable of storing and dispensing the required oxygen supplies.
- (b) Pressurised aeroplanes operated above flight altitudes at which the pressure altitude in the passenger compartments is above 10 000 ft shall carry enough breathing oxygen to supply:
- (1) all crew members and:
 - (i) 100 % of the passengers for any period when the cabin pressure altitude exceeds 15 000 ft, but in no case less than 10 minutes' supply;
 - (ii) at least 30 % of the passengers, for any period when, in the event of loss of pressurisation and taking into account the circumstances of the flight, the pressure altitude in the passenger compartment will be between 14 000 ft and 15 000 ft; and
 - (iii) at least 10 % of the passengers for any period in excess of 30 minutes when the pressure altitude in the passenger compartment will be between 10 000 ft and 14 000 ft;
 - (2) all the occupants of the passenger compartment for no less than 10 minutes, in the case of aeroplanes operated at pressure altitudes above 25 000 ft, or operated below that altitude, but under conditions that will not allow them to descend safely to a pressure altitude of 13 000 ft within 4 minutes.
- (c) Pressurised aeroplanes operated at flight altitudes above 25 000 ft shall, in addition, be equipped with:
- (1) a device to provide a warning indication to the flight crew of any loss of pressurisation; and
 - (2) quick donning masks for flight crew members.

AMC1 NCC.IDE.A.195 Supplemental oxygen — pressurised aeroplanes**DETERMINATION OF OXYGEN**

- (a) In the determination of the amount of oxygen required for the routes to be flown, it is assumed that the aeroplane will descend in accordance with the emergency procedures specified in the operations manual, without exceeding its operating limitations, to a flight altitude that will allow the flight to be completed safely (i.e. flight altitudes ensuring adequate terrain clearance, navigational accuracy, hazardous weather avoidance, etc.).
- (b) The amount of oxygen should be determined on the basis of cabin pressure altitude and flight duration, and on the assumption that a cabin pressurisation failure will occur at the pressure altitude or point of flight that is most critical from the standpoint of oxygen need.
- (c) Following a cabin pressurisation failure, the cabin pressure altitude should be considered to be the same as the aeroplane pressure altitude, unless it can be demonstrated to the competent authority that no probable failure of the cabin or pressurisation system will result in a cabin pressure altitude equal to the aeroplane pressure altitude. Under these circumstances, the demonstrated maximum cabin pressure altitude may be used as a basis for determination of oxygen supply.

GM1 NCC.IDE.A.195(c)(2) Supplemental oxygen – pressurised aeroplanes

QUICK DONNING MASKS

A quick donning mask is a type of mask that:

- (a) can be placed on the face from its ready position, properly secured, sealed and supplying oxygen upon demand, with one hand and within 5 seconds and will thereafter remain in position, both hands being free;
- (b) can be donned without disturbing eye glasses and without delaying the flight crew member from proceeding with assigned emergency duties;
- (c) once donned, does not prevent immediate communication between the flight crew members and other crew members over the aircraft intercommunication system; and
- (d) does not inhibit radio communications.

NCC.IDE.A.200 Supplemental oxygen — non-pressurised aeroplanes

- (a) Non-pressurised aeroplanes operated at flight altitudes when the oxygen supply is required in accordance with (b) shall be equipped with oxygen storage and dispensing apparatus capable of storing and dispensing the required oxygen supplies.
- (b) Non-pressurised aeroplanes operated above flight altitudes at which the pressure altitude in the passenger compartments is above 10 000 ft shall carry enough breathing oxygen to supply:
 - (1) all crew members and at least 10 % of the passengers for any period in excess of 30 minutes when the pressure altitude in the passenger compartment will be between 10 000 ft and 13 000 ft; and
 - (2) all crew members and passengers for any period that the pressure altitude in the passenger compartments will be above 13 000 ft.

AMC1 NCC.IDE.A.200 Supplemental oxygen — non-pressurised aeroplanes

DETERMINATION OF OXYGEN

- (a) On routes where the oxygen is necessary to be carried for 10 % of the passengers for the flight time between 10 000 ft and 13 000 ft, the oxygen may be provided by:
 - (1) a plug-in or drop-out oxygen system with sufficient outlets and dispensing units uniformly distributed throughout the cabin so as to provide oxygen to each passenger at his/her own discretion when seated on his/her assigned seat; or
 - (2) portable bottles, when a cabin crew member is required for the flight.
- (b) The amount of supplemental oxygen for sustenance for a particular operation should be determined on the basis of flight altitudes and flight duration, consistent with the operating procedures, including emergency procedures, established for each operation and the routes to be flown, as specified in the operations manual.

NCC.IDE.A.205 Hand fire extinguishers

- (a) Aeroplanes shall be equipped with at least one hand fire extinguisher:
 - (1) in the flight crew compartment; and
 - (2) in each passenger compartment that is separate from the flight crew compartment, except if the compartment is readily accessible to the flight crew.
- (b) The type and quantity of extinguishing agent for the required fire extinguishers shall be suitable for the type of fire likely to occur in the compartment where the extinguisher is intended to be used and to minimise the hazard of toxic gas concentration in compartments occupied by persons.

AMC1 NCC.IDE.A.205 Hand fire extinguishers

NUMBER, LOCATION AND TYPE

- (a) The number and location of hand fire extinguishers should be such as to provide adequate availability for use, account being taken of the number and size of the passenger compartments, the need to minimise the hazard of toxic gas concentrations and the location of toilets, galleys, etc. These considerations may result in the number of fire extinguishers being greater than the minimum required.
- (b) There should be at least one hand fire extinguisher installed in the flight crew compartment and this should be suitable for fighting both flammable fluid and electrical equipment fires. Additional hand fire extinguishers may be required for the protection of other compartments accessible to the crew in flight. Dry chemical fire extinguishers should not be used in the flight crew compartment, or in any compartment not separated by a partition from the flight crew compartment, because of the adverse effect on vision during discharge and, if conductive, interference with electrical contacts by the chemical residues.
- (c) Where only one hand fire extinguisher is required in the passenger compartments, it should be located near the cabin crew member's station, where provided.
- (d) Where two or more hand fire extinguishers are required in the passenger compartments and their location is not otherwise dictated by consideration of (a), an extinguisher should be located near each end of the cabin with the remainder distributed throughout the cabin as evenly as is practicable.
- (e) Unless an extinguisher is clearly visible, its location should be indicated by a placard or sign. Appropriate symbols may also be used to supplement such a placard or sign.

NCC.IDE.A.206 Crash axe and crowbar

- (a) Aeroplanes with an MCTOM of more than 5 700 kg or with an MOPSC of more than nine shall be equipped with at least one crash axe or crowbar located in the flight crew compartment.
- (b) In the case of aeroplanes with an MOPSC of more than 200, an additional crash axe or crowbar shall be installed in or near the rearmost galley area.
- (c) Crash axes and crowbars located in the passenger compartment shall not be visible to passengers.

NCC.IDE.A.210 Marking of break-in points

If areas of the aeroplane's fuselage suitable for break-in by rescue crews in an emergency are marked, such areas shall be marked as shown in Figure 1.

Figure 1

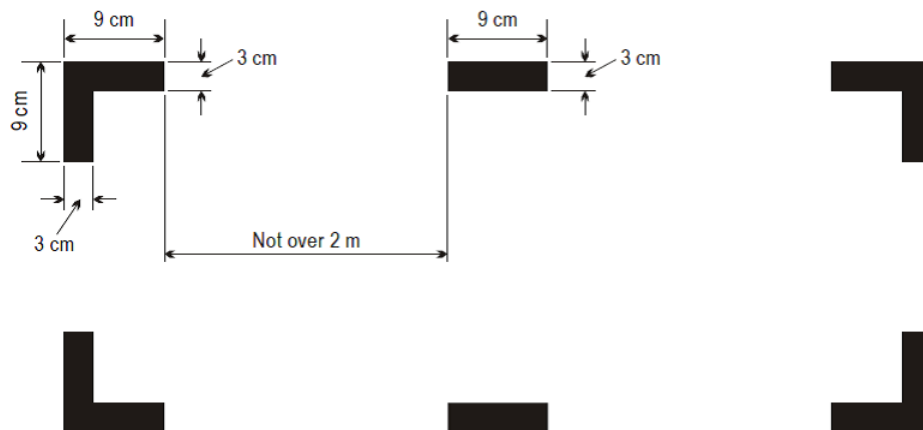
Marking of break-in points**AMC1 NCC.IDE.A.210 Marking of break-in points****MARKINGS – COLOUR AND CORNERS**

- (a) The colour of the markings should be red or yellow and, if necessary, should be outlined in white to contrast with the background.
- (b) If the corner markings are more than 2 m apart, intermediate lines 9 cm x 3 cm should be inserted so that there is no more than 2 m between adjacent markings.

NCC.IDE.A.215 Emergency locator transmitter (ELT)

- (a) Aeroplanes shall be equipped with:
- (1) an ELT of any type or an aircraft localisation means meeting the requirement of Annex IV (Part CAT), CAT.GEN.MPA.210, to Regulation (EU) No 965/2012, when first issued with an individual CofA on or before 1 July 2008;
 - (2) an automatic ELT or an aircraft localisation means meeting the requirement of Annex IV (Part CAT), CAT. GEN.MPA.210, to Regulation (EU) No 965/2012, when first issued with an individual CofA after 1 July 2008.
- (b) ELTs of any type shall be capable of transmitting simultaneously on 121,5 MHz and 406 MHz.

AMC1 NCC.IDE.A.215 Emergency locator transmitter (ELT)

ELT BATTERIES

Batteries used in the ELTs should be replaced (or recharged, if the battery is rechargeable) when the equipment has been in use for more than 1 cumulative hour, and also when 50 % of their useful life (or for rechargeable, 50 % of their useful life of charge), as established by the equipment manufacturer, has expired. The new expiry date for the replacement (or recharged) battery should be legibly marked on the outside of the equipment. The battery useful life (or useful life of charge) requirements of this paragraph do not apply to batteries (such as water-activated batteries) that are essentially unaffected during probable storage intervals.

AMC2 NCC.IDE.A.215 Emergency locator transmitter (ELT)

TYPES OF ELT AND GENERAL TECHNICAL SPECIFICATIONS

- (a) The ELT required by this provision should be one of the following:
- (1) Automatic fixed (ELT(AF)). An automatically activated ELT that is permanently attached to an aircraft and is designed to aid search and rescue (SAR) teams in locating the crash site.
 - (2) Automatic portable (ELT(AP)). An automatically activated ELT that is rigidly attached to an aircraft before a crash, but is readily removable from the aircraft after a crash. It functions as an ELT during the crash sequence. If the ELT does not employ an integral antenna, the aircraft-mounted antenna may be disconnected and an auxiliary antenna (stored on the ELT case) attached to the ELT. The ELT can be tethered to a survivor or a life-raft. This type of ELT is intended to aid SAR teams in locating the crash site or survivor(s).
 - (3) Automatic deployable (ELT(AD)). An ELT that is rigidly attached to the aircraft before the crash and that is automatically ejected, deployed and activated by an impact, and, in some cases, also by hydrostatic sensors. Manual deployment is also provided. This type of ELT should float in water and is intended to aid SAR teams in locating the crash site.
 - (4) Survival ELT (ELT(S)). An ELT that is removable from an aircraft, stowed so as to facilitate its ready use in an emergency and manually activated by a survivor. An ELT(S) may be activated manually or automatically (e.g. by water activation). It should be designed either to be tethered to a life-raft or a survivor.
- (b) To minimise the possibility of damage in the event of crash impact, the automatic ELT should be rigidly fixed to the aircraft structure, as far aft as is practicable, with its antenna and connections arranged so as to maximise the probability of the signal being transmitted after a crash.

- (c) Any ELT carried should operate in accordance with the relevant provisions of ICAO Annex 10, Volume III and should be registered with the national agency responsible for initiating search and rescue or other nominated agency.

NCC.IDE.A.220 Flight over water

- (a) The following aeroplanes shall be equipped with a life-jacket for each person on board or equivalent individual floatation device for each person on board younger than 24 months, stowed in a position that is readily accessible from the seat or berth of the person for whose use it is provided:
- (1) landplanes operated over water at a distance of more than 50 NM from land or taking off or landing at an aerodrome or operating site where, in the opinion of the pilot-in-command, the take-off or approach path is so disposed over water that there would be a likelihood of a ditching; and
 - (2) seaplanes operated over water.
- (b) Each life-jacket or equivalent individual floatation device shall be equipped with a means of electric illumination for the purpose of facilitating the location of persons.
- (c) Seaplanes operated over water shall be equipped with:
- (1) a sea anchor and other equipment necessary to facilitate mooring, anchoring or manoeuvring the aeroplane on water, appropriate to its size, weight and handling characteristics; and
 - (2) equipment for making the sound signals as prescribed in the International Regulations for Preventing Collisions at Sea, where applicable.
- (d) The pilot-in-command of an aeroplane operated at a distance away from land where an emergency landing is possible greater than that corresponding to 30 minutes at normal cruising speed or 50 NM, whichever is the lesser, shall determine the risks to survival of the occupants of the aeroplane in the event of a ditching, based on which he/she shall determine the carriage of:
- (1) equipment for making the distress signals;
 - (2) life-rafts in sufficient numbers to carry all persons on board, stowed so as to facilitate their ready use in emergency; and
 - (3) life-saving equipment to provide the means of sustaining life, as appropriate to the flight to be undertaken.

AMC1 NCC.IDE.A.220 Flight over water**ACCESSIBILITY OF LIFE-JACKETS**

The life-jacket should be accessible from the seat or berth of the person for whose use it is provided, with a safety belt or restraint system fastened.

ELECTRIC ILLUMINATION OF LIFE-JACKETS

The means of electric illumination should be a survivor locator light as defined in the applicable ETSO issued by the Agency or equivalent.

RISK ASSESSMENT

- (a) When conducting the risk assessment, the pilot-in-command should base his/her decision, as far as is practicable, on the Implementing Rules and AMCs applicable to the operation of the aeroplane.
- (b) The pilot-in-command should, for determining the risk, take the following operating environment and conditions into account:

- (1) sea state;
- (2) sea and air temperatures;
- (3) the distance from land suitable for making an emergency landing; and
- (4) the availability of search and rescue facilities.

AMC2 NCC.IDE.A.220 Flight over water

LIFE–RAFTS AND EQUIPMENT FOR MAKING DISTRESS SIGNALS

- (a) The following should be readily available with each life-raft:
 - (1) means for maintaining buoyancy;
 - (2) a sea anchor;
 - (3) life-lines and means of attaching one life-raft to another;
 - (4) paddles for life-rafts with a capacity of six or less;
 - (5) means of protecting the occupants from the elements;
 - (6) a water-resistant torch;
 - (7) signalling equipment to make the pyrotechnic distress signals described in ICAO Annex 2, Rules of the Air;
 - (8) 100 g of glucose tablets for each four, or fraction of four, persons that the life-raft is designed to carry;
 - (9) at least 2 litres of drinkable water provided in durable containers or means of making sea water drinkable or a combination of both; and
 - (10) first-aid equipment.
- (b) As far as practicable, items listed in (a) should be contained in a pack.

GM1 NCC.IDE.A.220 Flight over water

SEAT CUSHIONS

Seat cushions are not considered to be flotation devices.

NCC.IDE.A.230 Survival equipment

- (a) Aeroplanes operated over areas in which search and rescue would be especially difficult shall be equipped with:
- (1) signalling equipment to make the distress signals;
 - (2) at least one survival ELT(S); and
 - (3) additional survival equipment for the route to be flown taking account of the number of persons on board.
- (b) The additional survival equipment specified in (a)(3) does not need to be carried when the aeroplane:
- (1) remains within a distance from an area where search and rescue is not especially difficult corresponding to:
 - (i) 120 minutes at one-engine-inoperative (OEI) cruising speed for aeroplanes capable of continuing the flight to an aerodrome with the critical engine(s) becoming inoperative at any point along the route or planned diversion routes; or
 - (ii) 30 minutes at cruising speed for all other aeroplanes;or
 - (2) remains within a distance no greater than that corresponding to 90 minutes at cruising speed from an area suitable for making an emergency landing, for aeroplanes certified in accordance with the applicable airworthiness standard.

AMC1 NCC.IDE.A.230(a)(2) Survival equipment

SURVIVAL ELT

An ELT(AP) may be used to replace one required ELT(S) provided that it meets the ELT(S) requirements. A water-activated ELT(S) is not an ELT(AP).

AMC1 NCC.IDE.A.230(a)(3) Survival equipment

ADDITIONAL SURVIVAL EQUIPMENT

- (a) The following additional survival equipment should be carried when required:
- (1) 500 ml of water for each four, or fraction of four, persons on board;
 - (2) one knife;
 - (3) first-aid equipment; and
 - (4) one set of air/ground codes.
- (b) In addition, when polar conditions are expected, the following should be carried:
- (1) a means of melting snow;
 - (2) one snow shovel and one ice saw;
 - (3) sleeping bags for use by 1/3 of all persons on board and space blankets for the remainder or space blankets for all passengers on board; and
 - (4) one arctic/polar suit for each crew member carried.

- (c) If any item of equipment contained in the above list is already carried on board the aircraft in accordance with another requirement, there is no need for this to be duplicated.

AMC1 NCC.IDE.A.230(b)(2) Survival equipment

APPLICABLE AIRWORTHINESS STANDARD

The applicable airworthiness standard should be CS-25 or equivalent.

GM1 NCC.IDE.A.230 Survival equipment

SIGNALLING EQUIPMENT

The signalling equipment for making distress signals is described in ICAO Annex 2, Rules of the Air.

GM2 NCC.IDE.A.230 Survival equipment

AREAS IN WHICH SEARCH AND RESCUE WOULD BE ESPECIALLY DIFFICULT

The expression 'areas in which search and rescue would be especially difficult' should be interpreted, in this context, as meaning:

- (a) areas so designated by the competent authority responsible for managing search and rescue; or
- (b) areas that are largely uninhabited and where:
 - (1) the authority referred to in (a) has not published any information to confirm whether search and rescue would be or would not be especially difficult; and
 - (2) the authority referred to in (a) does not, as a matter of policy, designate areas as being especially difficult for search and rescue.

NCC.IDE.A.240 Headset

- (a) Aeroplanes shall be equipped with a headset with a boom microphone or equivalent for each flight crew member at their assigned station in the flight crew compartment.
- (b) Aeroplanes operated under IFR or at night shall be equipped with a transmit button on the manual pitch and roll control for each required flight crew member.

AMC1 NCC.IDE.A.240 Headset

GENERAL

- (a) A headset consists of a communication device that includes two earphones to receive and a microphone to transmit audio signals to the aeroplane's communication system. To comply with the minimum performance requirements, the earphones and microphone should match the communication system's characteristics and the flight crew compartment environment. The headset should be adequately adjustable in order to fit the flight crew's head. Headset boom microphones should be of the noise cancelling type.
- (b) If the intention is to utilise noise cancelling earphones, the operator should ensure that the earphones do not attenuate any aural warnings or sounds necessary for alerting the flight crew on matters related to the safe operation of the aeroplane.

GM1 NCC.IDE.A.240 Headset

GENERAL

The term 'headset' includes any aviation helmet incorporating headphones and microphone worn by a flight crew member.

NCC.IDE.A.245 Radio communication equipment

- (a) Aeroplanes operated under IFR or at night, or when required by the applicable airspace requirements, shall be equipped with radio communication equipment that, under normal radio propagating conditions, shall be capable of:
- (1) conducting two-way communication for aerodrome control purposes;
 - (2) receiving meteorological information at any time during flight;
 - (3) conducting two-way communication at any time during flight with those aeronautical stations and on those frequencies prescribed by the appropriate authority; and
 - (4) providing for communication on the aeronautical emergency frequency 121,5 MHz.
- (b) When more than one communication equipment unit is required, each shall be independent of the other or others to the extent that a failure in any one will not result in failure of any other.

GM1 NCC.IDE.A.245 Radio communication equipment**APPLICABLE AIRSPACE REQUIREMENTS**

For aeroplanes being operated under European air traffic control, the applicable airspace requirements include the Single European Sky legislation.

NCC.IDE.A.250 Navigation equipment

- (a) Aeroplanes shall be equipped with navigation equipment that will enable them to proceed in accordance with:
 - (1) the ATS flight plan, if applicable; and
 - (2) the applicable airspace requirements.
- (b) Aeroplanes shall have sufficient navigation equipment to ensure that, in the event of the failure of one item of equipment at any stage of the flight, the remaining equipment shall allow safe navigation in accordance with (a), or an appropriate contingency action, to be completed safely.
- (c) Aeroplanes operated on flights in which it is intended to land in IMC shall be equipped with suitable equipment capable of providing guidance to a point from which a visual landing can be performed. This equipment shall be capable of providing such guidance for each aerodrome at which it is intended to land in IMC and for any designated alternate aerodromes.
- (d) For PBN operations the aircraft shall meet the airworthiness certification requirements for the appropriate navigation specification.

GM1 NCC.IDE.A.250 Navigation equipment

AIRCRAFT ELIGIBILITY FOR PBN SPECIFICATION NOT REQUIRING SPECIFIC APPROVAL

- (a) The performance of the aircraft is usually stated in the AFM.
- (b) Where such a reference cannot be found in the AFM, other information provided by the aircraft manufacturer as TC holder, the STC holder or the design organisation having a privilege to approve minor changes may be considered.
- (c) The following documents are considered acceptable sources of information:
 - (1) AFM, supplements thereto, and documents directly referenced in the AFM;
 - (2) FCOM or similar document;
 - (3) Service Bulletin or Service Letter issued by the TC holder or STC holder;
 - (4) approved design data or data issued in support of a design change approval;
 - (5) any other formal document issued by the TC or STC holders stating compliance with PBN specifications, AMC, Advisory Circulars (AC) or similar documents issued by the State of Design; and
 - (6) written evidence obtained from the State of Design.
- (d) Equipment qualification data, in itself, is not sufficient to assess the PBN capabilities of the aircraft, since the latter depend on installation and integration.
- (e) As some PBN equipment and installations may have been certified prior to the publication of the PBN Manual and the adoption of its terminology for the navigation specifications, it is not always possible to find a clear statement of aircraft PBN capability in the AFM. However, aircraft eligibility for certain PBN specifications can rely on the aircraft performance certified for PBN procedures and routes prior to the publication of the PBN Manual.
- (f) Below, various references are listed which may be found in the AFM or other acceptable documents (see listing above) in order to consider the aircraft's eligibility for a specific PBN specification if the specific term is not used.
- (g) RNAV 5

-
- (1) If a statement of compliance with any of the following specifications or standards is found in the acceptable documentation as listed above, the aircraft is eligible for RNAV 5 operations.
- (i) B-RNAV;
 - (ii) RNAV 1;
 - (iii) RNP APCH;
 - (iv) RNP 4;
 - (v) A-RNP;
 - (vi) AMC 20-4;
 - (vii) JAA TEMPORARY GUIDANCE MATERIAL, LEAFLET NO. 2 (TGL 2);
 - (viii) JAA AMJ 20X2;
 - (ix) FAA AC 20-130A for en route operations;
 - (x) FAA AC 20-138 for en route operations; and
 - (xi) FAA AC 90-96.
- (h) RNAV 1/RNAV 2
- (1) If a statement of compliance with any of the following specifications or standards is found in the acceptable documentation as listed above, the aircraft is eligible for RNAV 1/RNAV 2 operations.
- (i) RNAV 1;
 - (ii) PRNAV;
 - (iii) US RNAV type A;
 - (iv) FAA AC 20-138 for the appropriate navigation specification;
 - (v) FAA AC 90-100A;
 - (vi) JAA TEMPORARY GUIDANCE MATERIAL, LEAFLET NO. 10 Rev1 (TGL 10); and
 - (vii) FAA AC 90-100.
- (2) However, if position determination is exclusively computed based on VOR-DME, the aircraft is not eligible for RNAV 1/RNAV 2 operations.
- (i) RNP 1/RNP 2 continental
- (1) If a statement of compliance with any of the following specifications or standards is found in the acceptable documentation as listed above, the aircraft is eligible for RNP 1/RNP 2 continental operations.
- (i) A-RNP;
 - (ii) FAA AC 20-138 for the appropriate navigation specification; and
 - (iii) FAA AC 90-105.
- (2) Alternatively, if a statement of compliance with any of the following specifications or standards is found in the acceptable documentation as listed above and position determination is primarily based on GNSS, the aircraft is eligible for RNP 1/RNP 2 continental operations.

However, in the cases mentioned in:

- (i) JAA TEMPORARY GUIDANCE MATERIAL, LEAFLET NO. 10 (TGL 10) (any revision); and
- (ii) FAA AC 90-100,

loss of GNSS implies loss of RNP 1/RNP 2 capability.

(j) RNP APCH — LNAV minima

- (1) If a statement of compliance with any of the following specifications or standards is found in the acceptable documentation as listed above, the aircraft is eligible for RNP APCH — LNAV operations.

- (i) A-RNP;
- (ii) AMC 20-27;
- (iii) AMC 20-28;
- (iv) FAA AC 20-138 for the appropriate navigation specification; and
- (v) FAA AC 90-105 for the appropriate navigation specification.

- (2) Alternatively, if a statement of compliance with RNP 0.3 GNSS approaches in accordance with any of the following specifications or standards is found in the acceptable documentation as listed above, the aircraft is eligible for RNP APCH — LNAV operations. Any limitation such as ‘within the US National Airspace’ may be ignored since RNP APCH procedures are assumed to meet the same ICAO criteria around the world.

- (i) JAA TEMPORARY GUIDANCE MATERIAL, LEAFLET NO. 3 (TGL 3);
- (ii) AMC 20-4;
- (iii) FAA AC 20-130A; and
- (iv) FAA AC 20-138.

(k) RNP APCH — LNAV/VNAV minima

- (1) If a statement of compliance with any of the following specifications or standards is found in the acceptable documentation as listed above, the aircraft is eligible for RNP APCH — LNAV/VNAV operations.

- (i) A-RNP;
- (ii) AMC 20-27 with Baro VNAV;
- (iii) AMC 20-28;
- (iv) FAA AC 20-138; and
- (v) FAA AC 90-105 for the appropriate navigation specification.

- (2) Alternatively, if a statement of compliance with FAA AC 20-129 is found in the acceptable documentation as listed above, and the aircraft complies with the requirements and limitations of EASA SIB 2014-045, the aircraft is eligible for RNP APCH — LNAV/VNAV operations. Any limitation such as ‘within the US National Airspace’ may be ignored since RNP APCH procedures are assumed to meet the same ICAO criteria around the world.

(l) RNP APCH — LPV minima

⁵ <http://ad.easa.europa.eu/ad/2014-04>

-
- (1) If a statement of compliance with any of the following specifications or standards is found in the acceptable documentation as listed above, the aircraft is eligible for RNP APCH — LPV operations.
 - (i) AMC 20-28;
 - (ii) FAA AC 20-138 for the appropriate navigation specification; and
 - (iii) FAA AC 90-107.
 - (2) For aircraft that have a TAWS Class A installed and do not provide Mode-5 protection on an LPV approach, the DH is limited to 250 ft.
- (m) RNAV 10
- (1) If a statement of compliance with any of the following specifications or standards is found in the acceptable documentation as listed above, the aircraft is eligible for RNAV 10 operations.
 - (i) RNP 10;
 - (ii) FAA AC 20-138 for the appropriate navigation specification;
 - (iii) AMC 20-12;
 - (iv) FAA Order 8400.12 (or later revision); and
 - (v) FAA AC 90-105.
- (n) RNP 4
- (1) If a statement of compliance with any of the following specifications or standards is found in the acceptable documentation as listed above, the aircraft is eligible for RNP 4 operations.
 - (i) FAA AC 20-138B or later, for the appropriate navigation specification;
 - (ii) FAA Order 8400.33; and
 - (iii) FAA AC 90-105 for the appropriate navigation specification.
- (o) RNP 2 oceanic
- (1) If a statement of compliance with FAA AC 90-105 for the appropriate navigation specification is found in the acceptable documentation as listed above, the aircraft is eligible for RNP 2 oceanic operations.
 - (2) If the aircraft has been assessed eligible for RNP 4, the aircraft is eligible for RNP 2 oceanic.
- (p) Special features
- (1) RF in terminal operations (used in RNP 1 and in the initial segment of the RNP APCH)
 - (i) If a statement of demonstrated capability to perform an RF leg, certified in accordance with any of the following specifications or standards, is found in the acceptable documentation as listed above, the aircraft is eligible for RF in terminal operations.
 - (A) AMC 20-26; and
 - (B) FAA AC 20-138B or later.
 - (ii) If there is a reference to RF and a reference to compliance with AC 90-105, then the aircraft is eligible for such operations.

- (q) Other considerations
- (1) In all cases, the limitations in the AFM need to be checked, in particular the use of AP or FD which can be required to reduce the FTE primarily for RNP APCH, RNAV 1, and RNP 1.
 - (2) Any limitation such as ‘within the US National Airspace’ may be ignored since RNP APCH procedures are assumed to meet the same ICAO criteria around the world.

GM2 NCC.IDE.A.250 Navigation equipment

GENERAL

- (a) The PBN specifications for which the aircraft complies with the relevant airworthiness criteria are set out in the AFM, together with any limitations to be observed.
- (b) Because functional and performance requirements are defined for each navigation specification, an aircraft approved for an RNP specification is not automatically approved for all RNAV specifications. Similarly, an aircraft approved for an RNP or RNAV specification having a stringent accuracy requirement (e.g. RNP 0.3 specification) is not automatically approved for a navigation specification having a less stringent accuracy requirement (e.g. RNP 4).

RNP 4

- (c) For RNP 4, at least two LRNSs, capable of navigating to RNP 4, and listed in the AFM, may be operational at the entry point of the RNP 4 airspace. If an item of equipment required for RNP 4 operations is unserviceable, then the flight crew may consider an alternate route or diversion for repairs. For multi-sensor systems, the AFM may permit entry if one GNSS sensor is lost after departure, provided one GNSS and one inertial sensor remain available.

NCC.IDE.A.255 Transponder

Aeroplanes shall be equipped with a pressure altitude reporting secondary surveillance radar (SSR) transponder and any other SSR transponder capability required for the route being flown.

AMC1 NCC.IDE.A.255 Transponder

SSR TRANSPONDER

- (a) The secondary surveillance radar (SSR) transponders of aeroplanes being operated under European air traffic control should comply with any applicable Single European Sky legislation.
- (b) If the Single European Sky legislation is not applicable, the SSR transponders should operate in accordance with the relevant provisions of Volume IV of ICAO Annex 10.

NCC.IDE.A.260 Electronic navigation data management

- Applicable until 01 January 2019, then replaced by the text below
- (a) The operator shall only use electronic navigation data products that support a navigation application meeting standards of integrity that are adequate for the intended use of the data.
 - (b) When the electronic navigation data products support a navigation application needed for an operation for which Annex V (Part-SPA) to Regulation (EU) No 965/2012 requires an approval, the operator shall demonstrate to the competent authority that the process applied and the delivered products meet standards of integrity that are adequate for the intended use of the data.
 - (c) The operator shall continuously monitor both the process and the products, either directly or by monitoring the compliance of third party providers.
 - (d) The operator shall ensure the timely distribution and insertion of current and unaltered electronic navigation data to all aeroplanes that require it.

NCC.IDE.A.260 Management of aeronautical databases

- Applicable from 01 January 2019. Will replace the text above.
- (a) Aeronautical databases used on certified aircraft system applications shall meet data quality requirements that are adequate for the intended use of the data.
 - (b) The operator shall ensure the timely distribution and insertion of current and unaltered aeronautical databases to all aircraft that require them.
 - (c) Notwithstanding any other occurrence reporting requirements as defined in Regulation (EU) No 376/2014, the operator shall report to the database provider instances of erroneous, inconsistent or missing data that might be reasonably expected to constitute a hazard to flight.

In such cases, the operator shall inform flight crew and other personnel concerned, and shall ensure that the affected data is not used.

AMC1 NCC.IDE.A.260 Electronic navigation data management

ELECTRONIC NAVIGATION DATA PRODUCTS

- (a) When the operator of a complex motor-powered aeroplane uses a navigation database that supports an airborne navigation application as a primary means of navigation, the navigation database supplier should hold a Type 2 letter of acceptance (LoA), or equivalent.
- (b) If this airborne navigation application is needed for an operation requiring a specific approval in accordance with Annex V (Part-SPA), the operator's procedures should be based upon the Type 2 LoA acceptance process.

GM1 NCC.IDE.A.260 Electronic navigation data management

LETTERS OF ACCEPTANCE AND STANDARDS FOR ELECTRONIC NAVIGATION DATA PRODUCTS

- (a) A Type 2 LoA is issued by the Agency in accordance with the Agency's Opinion No 01/2005 on The Acceptance of Navigation Database Suppliers (hereinafter referred to as the Agency's Opinion No 01/2005). The definitions of navigation database, navigation database supplier, data application integrator, Type 1 LoA and Type 2 LoA can be found in the Agency's Opinion No 01/2005.
- (b) Equivalent to a Type 2 LoA is the FAA Type 2 LoA, issued in accordance with the Federal Aviation Administration (FAA) Advisory Circular AC 20-153 or AC 20-153A, and the Transport Canada Civil Aviation (TCCA) 'Acknowledgement Letter of an Aeronautical Data Process', which uses the same basis.

- (c) EUROCAE ED-76/Radio Technical Commission for Aeronautics (RTCA) DO-200A Standards for Processing Aeronautical Data contains guidance relating to the processes which the supplier may follow.

SECTION 2
Helicopters**NCC.IDE.H.100 Instruments and equipment — general**

- (a) Instruments and equipment required by this Subpart shall be approved in accordance with the applicable airworthiness requirements if they are:
- (1) used by the flight crew to control the flight path;
 - (2) used to comply with NCC.IDE.H.245;
 - (3) used to comply with NCC.IDE.H.250; or
 - (4) installed in the helicopter.
- (b) The following items, when required by this Subpart, do not need an equipment approval:
- (1) independent portable light;
 - (2) an accurate time piece;
 - (3) chart holder;
 - (4) first-aid kit;
 - (5) survival and signalling equipment;
 - (6) sea anchor and equipment for mooring; and
 - (7) child restraint device.
- (c) Instruments and equipment not required by this Subpart as well as any other equipment which is not required by other applicable Annexes, but is carried on a flight, shall comply with the following:
- (1) the information provided by these instruments, equipment or accessories shall not be used by the flight crew to comply with Annex I to Regulation (EC) No 216/2008 or NCC.IDE.H.245 and NCC.IDE.H.250; and
 - (2) the instruments and equipment shall not affect the airworthiness of the helicopter, even in the case of failures or malfunction.
- (d) Instruments and equipment shall be readily operable or accessible from the station where the flight crew member that needs to use it is seated.
- (e) Those instruments that are used by a flight crew member shall be so arranged as to permit the flight crew member to see the indications readily from his/her station, with the minimum practicable deviation from the position and line of vision which he/she normally assumes when looking forward along the flight path.
- (f) All required emergency equipment shall be easily accessible for immediate use.

GM1 NCC.IDE.H.100(a) Instruments and equipment — general

APPLICABLE AIRWORTHINESS REQUIREMENTS

The applicable airworthiness requirements for approval of instruments and equipment required by this Part are the following:

- (a) Regulation (EC) 748/2012 for:
 - (1) helicopters registered in the EU; and
 - (2) helicopters registered outside the EU but manufactured or designed by an EU organisation.
- (b) Airworthiness requirements of the state of registry for helicopters registered, designed and manufactured outside the EU.

GM1 NCC.IDE.H.100(b)&(c) Instruments and equipment — general

INSTRUMENTS AND EQUIPMENT THAT DO NOT NEED TO BE APPROVED

- (a) The provision of this paragraph does not exempt the item of equipment from complying with the applicable airworthiness requirements if the instrument or equipment is installed in the helicopter. In this case, the installation should be approved as required in the applicable airworthiness requirements and should comply with the applicable Certification Specifications.
- (b) The functionality of non-installed instruments and equipment required by this Part that do not need an equipment approval should be checked against recognised industry standards appropriate for the intended purpose. The operator is responsible for ensuring the maintenance of these instruments and equipment.
- (c) The failure of additional non-installed instruments or equipment not required by this Part or by the applicable airworthiness requirements or any applicable airspace requirements should not adversely affect the airworthiness and/or the safe operation of the aircraft. Examples are the following:
 - (1) instruments supplying additional flight information (e.g. stand-alone global positioning system (GPS));
 - (2) some aerial work equipment (e.g. some mission dedicated radios, wire cutters); and
 - (3) non-installed passenger entertainment equipment.

GM1 NCC.IDE.H.100(d) Instruments and equipment — general

POSITIONING OF INSTRUMENTS

This requirement implies that whenever a single instrument is required in a helicopter operated in a multi-crew environment, the instrument needs to be visible from each flight crew station.

NCC.IDE.H.105 Minimum equipment for flight

A flight shall not be commenced when any of the helicopter's instruments, items of equipment or functions required for the intended flight are inoperative or missing, unless:

- (a) the helicopter is operated in accordance with the operator's minimum equipment list (MEL);
- (b) the operator is approved by the competent authority to operate the helicopter within the constraints of the master minimum equipment list (MMEL); or
- (c) the helicopter is subject to a permit to fly issued in accordance with the applicable airworthiness requirements.

NCC.IDE.H.115 Operating lights

Helicopters operated at night shall be equipped with:

- (a) an anti-collision light system;
- (b) navigation/position lights;
- (c) a landing light;
- (d) lighting supplied from the helicopter's electrical system to provide adequate illumination for all instruments and equipment essential to the safe operation of the helicopter;
- (e) lighting supplied from the helicopter's electrical system to provide illumination in all passenger compartments;
- (f) an independent portable light for each crew member station; and
- (g) lights to conform with the International Regulations for Preventing Collisions at Sea if the helicopter is amphibious.

AMC1 NCC.IDE.H.115 Operating lights**LANDING LIGHT**

The landing light should be trainable, at least in the vertical plane.

NCC.IDE.H.120 Operations under VFR — flight and navigational instruments and associated equipment

- (a) Helicopters operated under VFR by day shall be equipped with a means of measuring and displaying the following:
- (1) magnetic heading;
 - (2) time in hours, minutes and seconds;
 - (3) pressure altitude;
 - (4) indicated airspeed; and
 - (5) slip.
- (b) Helicopters operated under VMC over water and out of sight of the land, or under VMC at night, or when the visibility is less than 1 500 m, or in conditions where the helicopter cannot be maintained in a desired flight path without reference to one or more additional instruments, shall be equipped, in addition to (a), with:
- (1) a means of measuring and displaying the following:
 - (i) attitude;
 - (ii) vertical speed; and
 - (iii) stabilised heading;
 - (2) a means of indicating when the supply of power to the gyroscopic instruments is not adequate; and
 - (3) a means of preventing malfunction of the airspeed indicating system required in (a)(4) due to condensation or icing.
- (c) Whenever two pilots are required for the operation, helicopters shall be equipped with an additional separate means of displaying the following:
- (1) pressure altitude;
 - (2) indicated airspeed;
 - (3) slip;
 - (4) attitude, if applicable;
 - (5) vertical speed, if applicable; and
 - (6) stabilised heading, if applicable.

AMC1 NCC.IDE.H.120&NCC.IDE.H.125 Operations under VFR & operations under IFR — flight and navigational instruments and associated equipment**INTEGRATED INSTRUMENTS**

- (a) Individual equipment requirements may be met by combinations of instruments or by integrated flight systems or by a combination of parameters on electronic displays. The information so available to each required pilot should not be less than that required in the applicable operational requirements, and the equivalent safety of the installation should be approved during type certification of the helicopter for the intended type of operation.

- (b) The means of measuring and indicating slip, helicopter attitude and stabilised helicopter heading may be met by combinations of instruments or by integrated flight director systems, provided that the safeguards against total failure, inherent in the three separate instruments, are retained.

AMC1 NCC.IDE.H.120(a)(1)&NCC.IDE.H.125(a)(1) Operations under VFR & operations under IFR — flight and navigational instruments and associated equipment

MEANS OF MEASURING AND DISPLAYING MAGNETIC HEADING

The means of measuring and displaying magnetic heading should be a magnetic compass or equivalent.

AMC1 NCC.IDE.H.120(a)(2)&NCC.IDE.H.125(a)(2) Operations under VFR & operations under IFR — flight and navigational instruments and associated equipment

MEANS FOR MEASURING AND DISPLAYING THE TIME

An acceptable means of compliance is be a clock displaying hours, minutes and seconds, with a sweep-second pointer or digital presentation.

AMC1 NCC.IDE.H.120(a)(3)&NCC.IDE.H.125(a)(3) Operations under VFR & operations under IFR — flight and navigational instruments and associated equipment

CALIBRATION OF THE MEANS FOR MEASURING AND DISPLAYING PRESSURE ALTITUDE

The instrument measuring and displaying pressure altitude should be of a sensitive type calibrated in feet (ft), with a sub-scale setting, calibrated in hectopascals/millibars, adjustable for any barometric pressure likely to be set during flight.

AMC1 NCC.IDE.H.120(a)(4)&NCC.IDE.H.125(a)(4) Operations under VFR & operations under IFR — flight and navigational instruments and associated equipment

CALIBRATION OF THE INSTRUMENT INDICATING AIRSPEED

The instrument indicating airspeed should be calibrated in knots (kt).

AMC1 NCC.IDE.H.120(b)(1)(iii)&NCC.IDE.H.125(a)(8) Operations under VFR & operations under IFR — flight and navigational instruments and associated equipment

STABILISED HEADING

Stabilised heading should be achieved for VFR flights by a gyroscopic heading indicator, whereas for IFR flights this should be achieved through a magnetic gyroscopic heading indicator.

NCC.IDE.H.125 Operations under IFR — flight and navigational instruments and associated equipment

Helicopters operated under IFR shall be equipped with:

- (a) a means of measuring and displaying the following:
 - (1) magnetic heading;
 - (2) time in hours, minutes and seconds;
 - (3) pressure altitude;
 - (4) indicated airspeed;
 - (5) vertical speed;
 - (6) slip;
 - (7) attitude;
 - (8) stabilised heading; and
 - (9) outside air temperature;
- (b) a means of indicating when the supply of power to the gyroscopic instruments is not adequate;
- (c) whenever two pilots are required for the operation, an additional separate means of displaying the following:
 - (1) pressure altitude;
 - (2) indicated airspeed;
 - (3) vertical speed;
 - (4) slip;
 - (5) attitude; and
 - (6) stabilised heading;
- (d) a means of preventing malfunction of the airspeed indicating systems required in (a)(4) and (c)(2) due to condensation or icing;
- (e) an alternate source of static pressure;
- (f) a chart holder in an easily readable position that can be illuminated for night operations; and
- (g) an additional means of measuring and displaying attitude as a standby instrument.

AMC1 NCC.IDE.H.125(a)(9) Operations under IFR — flight and navigational instruments and associated equipment**OUTSIDE AIR TEMPERATURE**

- (a) The means of displaying outside air temperature should be calibrated in degrees Celsius.
- (b) The means of displaying outside air temperature may be an air temperature indicator that provides indications that are convertible to outside air temperature.

AMC1 NCC.IDE.H.120(c)&NCC.IDE.H.125(c) Operations under VFR & operations under IFR — flight and navigational instruments and associated equipment**MULTI-PILOT OPERATIONS — DUPLICATE INSTRUMENTS**

Duplicate instruments include separate displays for each pilot and separate selectors or other associated equipment where appropriate.

AMC1 NCC.IDE.H.125(d) Operations under VFR & operations under IFR — flight and navigational instruments and associated equipment**MEANS OF PREVENTING MALFUNCTION DUE TO CONDENSATION OR ICING**

The means of preventing malfunction due to either condensation or icing of the airspeed indicating system should be a heated pitot tube or equivalent.

AMC1 NCC.IDE.H.125(f) Operations under IFR — flight and navigational instruments and associated equipment**CHART HOLDER**

An acceptable means of compliance with the chart holder requirement is to display a pre-composed chart on an electronic flight bag (EFB).

NCC.IDE.H.130 Additional equipment for single-pilot operations under IFR

Helicopters operated under IFR with a single pilot shall be equipped with an autopilot with at least altitude hold and heading mode.

NCC.IDE.H.145 Airborne weather detecting equipment

Helicopters with an MOPSC of more than nine and operated under IFR or at night shall be equipped with airborne weather detecting equipment when current weather reports indicate that thunderstorms or other potentially hazardous weather conditions, regarded as detectable with airborne weather detecting equipment, may be expected to exist along the route to be flown.

AMC1 NCC.IDE.H.145 Airborne weather detecting equipment**GENERAL**

The airborne weather detecting equipment should be an airborne weather radar.

NCC.IDE.H.150 Additional equipment for operations in icing conditions at night

- (a) Helicopters operated in expected or actual icing conditions at night shall be equipped with a means to illuminate or detect the formation of ice.
- (b) The means to illuminate the formation of ice shall not cause glare or reflection that would handicap flight crew members in the performance of their duties.

NCC.IDE.H.155 Flight crew interphone system

Helicopters operated by more than one flight crew member shall be equipped with a flight crew interphone system, including headsets and microphones for use by all flight crew members.

AMC1 NCC.IDE.H.155 Flight crew interphone system

TYPE OF FLIGHT CREW INTERPHONE

The flight crew interphone system should not be of a handheld type.

NCC.IDE.H.160 Cockpit voice recorder

- (a) Helicopters with an MCTOM of more than 7 000 kg and first issued with an individual CofA on or after 1 January 2016 shall be equipped with a CVR.
- (b) The CVR shall be capable of retaining data recorded during at least the preceding 2 hours.
- (c) The CVR shall record with reference to a timescale:
 - (1) voice communications transmitted from or received in the flight crew compartment by radio;
 - (2) flight crew members' voice communications using the interphone system and the public address system, if installed;
 - (3) the aural environment of the cockpit, including, without interruption, the audio signals received from each crew microphone; and
 - (4) voice or audio signals identifying navigation or approach aids introduced into a headset or speaker.
- (d) The CVR shall start automatically to record prior to the helicopter moving under its own power and shall continue to record until the termination of the flight when the helicopter is no longer capable of moving under its own power.
- (e) In addition to (d), depending on the availability of electrical power, the CVR shall start to record as early as possible during the cockpit checks prior to engine start at the beginning of the flight until the cockpit checks immediately following engine shutdown at the end of the flight.
- (f) If the CVR is not deployable, it shall have a device to assist in locating it under water. By 1 January 2020 at the latest, this device shall have a minimum underwater transmission time of 90 days. If the CVR is deployable, it shall have an automatic emergency locator transmitter.

AMC1 NCC.IDE.H.160 Cockpit voice recorder

GENERAL

- (a) The operational performance requirements for cockpit voice recorders (CVRs) should be those laid down in EUROCAE Document ED-112 Minimum Operational Performance Specification for Crash Protected Airborne Recorder Systems, March 2003, including Amendments No°1 and No°2, or any later equivalent standard produced by EUROCAE.
- (b) The operational performance requirements for equipment dedicated to the CVR should be those laid down in the European Organisation for Civil Aviation Equipment (EUROCAE) Document ED-56A (Minimum Operational Performance Requirements For Cockpit Voice Recorder Systems) dated December 1993, or EUROCAE Document ED-112 (Minimum Operational Performance Specification for Crash Protected Airborne Recorder Systems) dated March 2003, including Amendments No°1 and No°2, or any later equivalent standard produced by EUROCAE.

NCC.IDE.H.165 Flight data recorder

- (a) Helicopters with an MCTOM of more than 3 175 kg and first issued with an individual CofA on or after 1 January 2016 shall be equipped with an FDR that uses a digital method of recording and storing data and for which a method of readily retrieving that data from the storage medium is available.
- (b) The FDR shall record the parameters required to determine accurately the helicopter flight path, speed, attitude, engine power, configuration and operation and be capable of retaining data recorded during at least the preceding 10 hours.
- (c) Data shall be obtained from helicopter sources that enable accurate correlation with information displayed to the flight crew.
- (d) The FDR shall start automatically to record the data prior to the helicopter being capable of moving under its own power and shall stop automatically after the helicopter is incapable of moving under its own power.
- (e) If the FDR is not deployable, it shall have a device to assist in locating it under water. By 1 January 2020 at the latest, this device shall have a minimum underwater transmission time of 90 days. If the FDR is deployable, it shall have an automatic emergency locator transmitter.

AMC1 NCC.IDE.H.165 Flight data recorder

OPERATIONAL PERFORMANCE REQUIREMENTS FOR HELICOPTERS HAVING AN MCTOM OF MORE THAN 3 175 KG AND FIRST ISSUED WITH AN INDIVIDUAL CofA ON OR AFTER 1 JANUARY 2016 AND BEFORE 1 JANUARY 2023

- (a) The operational performance requirements for flight data recorders (FDRs) should be those laid down in EUROCAE Document ED-112 (Minimum Operational Performance Specification for Crash Protected Airborne Recorder Systems) dated March 2003, including amendments n°1 and n°2, or any later equivalent standard produced by EUROCAE.
- (b) The FDR should record, with reference to a timescale, the list of parameters in Table 1 and Table 2, as applicable.
- (c) The parameters recorded by the FDR should meet, as far as practicable, the performance specifications (designated ranges, sampling intervals, accuracy limits and minimum resolution in read-out) defined in EUROCAE ED-112, including amendments n°1 and n°2, or any later equivalent standard produced by EUROCAE.
- (d) FDR systems for which some recorded parameters do not meet the performance specifications of EUROCAE Document ED-112 may be acceptable to the Agency.

Table 1: FDR parameters — All helicopters

No*	Parameter
1	Time or relative time count
2	Pressure altitude
3	Indicated airspeed
4	Heading

No*	Parameter
5	Normal acceleration
6	Pitch attitude
7	Roll attitude
8	Manual radio transmission keying CVR/FDR synchronisation reference
9	Power on each engine:
9a	Free power turbine speed (N_F)
9b	Engine torque
9c	Engine gas generator speed (N_G)
9d	Flight crew compartment power control position
9e	Other parameters to enable engine power to be determined
10	Rotor:
10a	Main rotor speed
10b	Rotor brake (if installed)
11	Primary flight controls — Pilot input and/or control output position (if applicable):
11a	Collective pitch
11b	Longitudinal cyclic pitch
11c	Lateral cyclic pitch
11d	Tail rotor pedal
11e	Controllable stabilator (if applicable)
11f	Hydraulic selection
12	Hydraulics low pressure (each system should be recorded.)
13	Outside air temperature
18	Yaw rate or yaw acceleration
20	Longitudinal acceleration (body axis)
21	Lateral acceleration
25	Marker beacon passage
26	Warnings — a discrete should be recorded for the master warning, gearbox low oil pressure and stability augmentation system as failure. Other ‘red’ warnings should be recorded where the warning condition cannot be determined from other parameters or from the cockpit voice recorder.

No*	Parameter
27	Each navigation receiver frequency selection
37	Engine control modes

* The number in the left hand column reflects the serial number depicted in EUROCAE ED-112.

Table 2: FDR parameters — Helicopters for which the data source for the parameter is either used by helicopter systems or is available on the instrument panel for use by the flight crew to operate the helicopter

No*	Parameter
14	AFCS mode and engagement status
15	Stability augmentation system engagement (each system should be recorded)
16	Main gear box oil pressure
17	Gear box oil temperature:
17a	Main gear box oil temperature
17b	Intermediate gear box oil temperature
17c	Tail rotor gear box oil temperature
19	Indicated sling load force (if signals readily available)
22	Radio altitude
23	Vertical deviation — the approach aid in use should be recorded:
23a	ILS glide path
23b	MLS elevation
23c	GNSS approach path
24	Horizontal deviation — the approach aid in use should be recorded:
24a	ILS localiser
24b	MLS azimuth
24c	GNSS approach path
28	DME 1 & 2 distances
29	Navigation data:
29a	Drift angle
29b	Wind speed
29c	Wind direction
29d	Latitude

No*	Parameter
29e	Longitude
29f	Ground speed
30	Landing gear or gear selector position
31	Engine exhaust gas temperature (T_4)
32	Turbine inlet temperature (TIT/ITT)
33	Fuel contents
34	Altitude rate (vertical speed) - only necessary when available from cockpit instruments
35	Ice detection
36	Helicopter health and usage monitor system (HUMS):
36a	Engine data
36b	Chip detector
36c	Track timing
36d	Exceedance discretets
36e	Broadband average engine vibration
38	Selected barometric setting — to be recorded for helicopters where the parameter is displayed electronically:
38a	Pilot
38b	Co-pilot
39	Selected altitude (all pilot selectable modes of operation) — to be recorded for the helicopters where the parameter is displayed electronically
40	Selected speed (all pilot selectable modes of operation) — to be recorded for the helicopters where the parameter is displayed electronically
41	Not used (selected Mach)
42	Selected vertical speed (all pilot selectable modes of operation) — to be recorded for the helicopters where the parameter is displayed electronically
43	Selected heading (all pilot selectable modes of operation) — to be recorded for the helicopters where the parameter is displayed electronically
44	Selected flight path (all pilot selectable modes of operation) — to be recorded for the helicopters where the parameter is displayed electronically
45	Selected decision height (all pilot selectable modes of operation) — to be recorded for the helicopters where the parameter is displayed electronically
46	EFIS display format

No*	Parameter
47	Multi-function/engine/alerts display format
48	Event marker

* The number in the left hand column reflects the serial number depicted in EUROCAE ED-112.

AMC2 NCC.IDE.H.165 Flight data recorder

OPERATIONAL PERFORMANCE REQUIREMENTS FOR HELICOPTERS HAVING AN MCTOM OF MORE THAN 3 175 KG AND FIRST ISSUED WITH AN INDIVIDUAL COFA ON OR AFTER 1 JANUARY 2023

- (a) The operational performance requirements for flight data recorders (FDRs) should be those laid down in EUROCAE Document 112A (Minimum Operational Performance Specification for Crash Protected Airborne Recorder Systems) dated September 2013, or any later equivalent standard produced by EUROCAE.
- (b) The FDR should, with reference to a timescale, record:
- (1) the list of parameters in Table 1 below;
 - (2) the additional parameters listed in Table 2 below, when the information data source for the parameter is used by helicopter systems or is available on the instrument panel for use by the flight crew to operate the helicopter; and
 - (3) any dedicated parameters related to novel or unique design or operational characteristics of the helicopter as determined by the Agency.
- (c) The parameters to be recorded should meet the performance specifications (range, sampling intervals, accuracy limits and resolution in read-out) as defined in the relevant tables of EUROCAE Document 112A, or any later equivalent standard produced by EUROCAE.

Table 1: FDR — All helicopters

No*	Parameter
1	Time or relative time count
2	Pressure altitude
3	Indicated airspeed or calibrated airspeed
4	Heading
5	Normal acceleration
6	Pitch attitude
7	Roll attitude
8	Manual radio transmission keying CVR/FDR synchronisation reference
9	Power on each engine:

No*	Parameter
9a	Free power turbine speed (N_F)
9b	Engine torque
9c	Engine gas generator speed (N_G)
9d	Flight crew compartment power control position
9e	Other parameters to enable engine power to be determined
10	Rotor:
10a	Main rotor speed
10b	Rotor brake (if installed)
11	Primary flight controls — pilot input or control output position if it is possible to derive either the control input or the control movement (one from the other) for all modes of operation and flight regimes. Otherwise, pilot input and control output position
11a	Collective pitch
11b	Longitudinal cyclic pitch
11c	Lateral cyclic pitch
11d	Tail rotor pedal
11e	Controllable stabilator (if applicable)
11f	Hydraulic selection
12	Hydraulics low pressure (each system should be recorded)
13	Outside air temperature
18	Yaw rate or yaw acceleration
20	Longitudinal acceleration (body axis)
21	Lateral acceleration
25	Marker beacon passage
26	Warnings — including master warning, gearbox low oil pressure and stability augmentation system failure, and other 'red' warnings where the warning condition cannot be determined from other parameters or from the cockpit voice recorder
27	Each navigation receiver frequency selection
37	Engine control modes

* The number in the left-hand column reflects the serial numbers depicted in EUROCAE Document 112A.

Table 2: Helicopters for which the data source for the parameter is either used by the helicopter systems or is available on the instrument panel for use by the flight crew to operate the helicopter

No*	Parameter
14	AFCS mode and engagement status (showing which systems are engaged and which primary modes are controlling the flight path)
15	Stability augmentation system engagement (each system should be recorded)
16	Main gear box oil pressure
17	Gear box oil temperature:
17a	Main gear box oil temperature
17b	Intermediate gear box oil temperature
17c	Tail rotor gear box oil temperature
19	Indicated sling load force (if signals readily available)
22	Radio altitude
23	Vertical deviation — the approach aid in use should be recorded:
23a	ILS glide path
23b	MLS elevation
23c	GNSS approach path
24	Horizontal deviation — the approach aid in use should be recorded:
24a	ILS localiser
24b	MLS azimuth
24c	GNSS approach path
28	DME 1 & 2 distances
29	Navigation data:
29a	Drift angle
29b	Wind speed
29c	Wind direction
29d	Latitude
29e	Longitude
29f	Ground speed
30	Landing gear or gear selector position
31	Engine exhaust gas temperature (T_4)

No*	Parameter
32	Turbine inlet temperature (TIT)/interstage turbine temperature (ITT)
33	Fuel contents
34	Altitude rate (vertical speed) — only necessary when available from cockpit instruments
35	Ice detection
36	Helicopter health and usage monitor system (HUMS):
36a	Engine data
36b	Chip detector
36c	Track timing
36d	Exceedance discretets
36e	Broadband average engine vibration
38	Selected barometric setting — to be recorded for helicopters where the parameter is displayed electronically:
38a	Pilot
38b	Co-pilot
39	Selected altitude (all pilot selectable modes of operation) — to be recorded for the helicopters where the parameter is displayed electronically.
40	Selected speed (all pilot selectable modes of operation) — to be recorded for the helicopters where the parameter is displayed electronically.
41	Selected Mach (all pilot selectable modes of operation) — to be recorded for the helicopters where the parameter is displayed electronically.
42	Selected vertical speed (all pilot selectable modes of operation) — to be recorded for the helicopters where the parameter is displayed electronically.
43	Selected heading (all pilot selectable modes of operation) — to be recorded for the helicopters where the parameter is displayed electronically.
44	Selected flight path (all pilot selectable modes of operation) — to be recorded for the helicopters where the parameter is displayed electronically.
45	Selected decision height (all pilot selectable modes of operation) — to be recorded for the helicopters where the parameter is displayed electronically.
46	EFIS display format (showing the display system status):
46a	Pilot
46b	First officer

No*	Parameter
47	Multi-function/engine/alerts display format (showing the display system status)
48	Event marker
49	Status of ground proximity warning system (GPWS)/terrain awareness warning system (TAWS)/ground collision avoidance system (GCAS):
49a	Selection of terrain display mode including pop-up display status — for helicopters type certified before 1 January 2023, to be recorded only if this does not require extensive modification.
49b	Terrain alerts, both cautions and warnings, and advisories — for helicopters type certified before 1 January 2023, to be recorded only if this does not require extensive modification
49c	On/off switch position — for helicopters type certified before 1 January 2023, to be recorded only if this does not require extensive modification
50	Traffic alert and collision avoidance system (TCAS)/airborne collision avoidance system (ACAS):
50a	Combined control — for helicopters type certified before 1 January 2023, to be recorded only if this does not require extensive modification.
50b	Vertical control — for helicopters type certified before 1 January 2023, to be recorded only if this does not require extensive modification.
50c	Up advisory — for helicopters type certified before 1 January 2023, to be recorded only if this does not require extensive modification.
50d	Down advisory — for helicopters type certified before 1 January 2023, to be recorded only if this does not require extensive modification.
50e	Sensitivity level — for helicopters type certified before 1 January 2023, to be recorded only if this does not require extensive modification.
51	Primary flight controls — pilot input forces:
51a	Collective pitch — for helicopters type certified before 1 January 2023, to be recorded only if this does not require extensive modification
51b	Longitudinal cyclic pitch — for helicopters type certified before 1 January 2023, to be recorded only if this does not require extensive modification.
51c	Lateral cyclic pitch — for helicopters type certified before 1 January 2023, to be recorded only if this does not require extensive modification.
51d	Tail rotor pedal — for helicopters type certified before 1 January 2023, to be recorded only if this does not require extensive modification.
52	Computed centre of gravity — for helicopters type certified before 1 January 2023, to be recorded only if this does not require extensive modification.
53	Helicopter computed weight — for helicopters type certified before 1 January 2023, to be recorded only if this does not require extensive modification.

* The number in the left-hand column reflects the serial numbers depicted in EUROCAE Document 112A.

NCC.IDE.H.170 Data link recording

- (a) Helicopters first issued with an individual CofA on or after 1 January 2016 that have the capability to operate data link communications and are required to be equipped with a CVR shall record on a recorder, where applicable:
- (1) data link communication messages related to ATS communications to and from the helicopter, including messages applying to the following applications:
 - (i) data link initiation;
 - (ii) controller–pilot communication;
 - (iii) addressed surveillance;
 - (iv) flight information;
 - (v) as far as is practicable, given the architecture of the system, aircraft broadcast surveillance;
 - (vi) as far as is practicable, given the architecture of the system, aircraft operational control data; and
 - (vii) as far as is practicable, given the architecture of the system, graphics;
 - (2) information that enables correlation to any associated records related to data link communications and stored separately from the helicopter; and
 - (3) information on the time and priority of data link communications messages, taking into account the system’s architecture.
- (b) The recorder shall use a digital method of recording and storing data and information and a method for readily retrieving that data. The recording method shall allow the data to match the data recorded on the ground.
- (c) The recorder shall be capable of retaining data recorded for at least the same duration as set out for CVRs in NCC.IDE.H.160.
- (d) If the recorder is not deployable, it shall have a device to assist in locating it under water. By 1 January 2020 at the latest, this device shall have a minimum underwater transmission time of 90 days. If the recorder is deployable, it shall have an automatic emergency locator transmitter.
- (e) The requirements applicable to the start and stop logic of the recorder are the same as the requirements applicable to the start and stop logic of the CVR contained in NCC.IDE.H.160(d) and (e).

AMC1 NCC.IDE.H.170 Data link recording

GENERAL

- (a) As a means of compliance with NCC.IDE.H.170, the recorder on which the data link messages are recorded should be:
- (1) the CVR;
 - (2) the FDR;
 - (3) a combination recorder when NCC.IDE.H.175 is applicable; or
 - (4) a dedicated flight recorder. In such a case, the operational performance requirements for this recorder should be those laid down in EUROCAE Document ED-112 (Minimum Operational Performance Specification for Crash Protected Airborne Recorder Systems),

dated March 2003, including amendments n°1 and n°2, or any later equivalent standard produced by EUROCAE.

- (b) As a means of compliance with NCC.IDE.H.170 (a)(2), the operator should enable correlation by providing information that allows an accident investigator to understand what data was provided to the aircraft and, when the provider identification is contained in the message, by which provider.
- (c) The timing information associated with the data link communications messages required to be recorded by NCC.IDE.H.170(a)(3) should be capable of being determined from the airborne-based recordings. This timing information should include at least the following:
- (1) the time each message was generated;
 - (2) the time any message was available to be displayed by the flight crew;
 - (3) the time each message was actually displayed or recalled from a queue; and
 - (4) the time of each status change.
- (d) The message priority should be recorded when it is defined by the protocol of the data link communication message being recorded.
- (e) The expression ‘taking into account the system’s architecture’, in NCC.IDE.H.170 (a)(3), means that the recording of the specified information may be omitted if the existing source systems involved would require a major upgrade. The following should be considered:
- (1) the extent of the modification required;
 - (2) the down-time period; and
 - (3) equipment software development.
- (f) Data link communications messages that support the applications in Table 1 should be recorded.
- (g) Further details on the recording requirements can be found in the recording requirement matrix in Appendix D.2 of EUROCAE Document ED-93 (Minimum Aviation System Performance Specification for CNS/ATM Recorder Systems), dated November 1998.

Table 1: Data link recording

Item No	Application Type	Application Description	Required Recording Content
1	Data link initiation	This includes any application used to log on to, or initiate, a data link service. In future air navigation system (FANS)-1/A and air traffic navigation (ATN), these are ATS facilities notification (AFN) and context management (CM), respectively.	C
2	Controller/pilot communication	This includes any application used to exchange requests, clearances, instructions and reports between the flight crew and controllers on the ground. In FANS-1/A and ATN, this includes the controller pilot data link communications (CPDLC) application. It also includes applications used for the exchange	C

Item No	Application Type	Application Description	Required Recording Content
		of oceanic clearances (OCL) and departure clearances (DCL), as well as data link delivery of taxi clearances.	
3	Addressed surveillance	This includes any surveillance application in which the ground sets up contracts for delivery of surveillance data. In FANS-1/A and ATN, this includes the automatic dependent surveillance-contract (ADS-C) application.	C, F2
4	Flight information	This includes any application used for delivery of flight information data to specific helicopters. This includes for example digital automatic terminal information service (D-ATIS), data link operational terminal information service (D-OTIS), digital weather information services (D-METAR or TWIP), data link-flight information service (D-FIS) and Notice to Airmen (electronic NOTAM) delivery.	C
5	Broadcast surveillance	This includes elementary and enhanced surveillance systems, as well as automatic dependent surveillance-broadcast (ADS-B) output data.	M*, F2
6	AOC data	This includes any application transmitting or receiving data used for AOC purposes (in accordance with the ICAO definition of AOC). Such systems may also process AAC messages, but there is no requirement to record AAC messages	M*
7	Graphics	This includes any application receiving graphical data to be used for operational purposes (i.e. excluding applications that are receiving such things as updates to manuals).	M* F1

GM1 NCC.IDE.H.170 Data link recording

GENERAL

- (a) The letters and expressions in Table 1 of AMC1 NCC.IDE.H.170 have the following meaning:
- (1) C: complete contents recorded.
 - (2) M: information that enables correlation with any associated records stored separately from the helicopter.

- (3) *: applications that are to be recorded only as far as is practicable, given the architecture of the system.
- (4) F1: graphics applications may be considered as AOC messages when they are part of a data link communications application service run on an individual basis by the operator itself in the framework of the operational control.
- (5) F2: where parametric data sent by the helicopter, such as Mode S, is reported within the message, it should be recorded unless data from the same source is recorded on the FDR.
- (b) The definitions of the applications type in Table 1 of AMC1 NCC.IDE.H.170 are described in Table 1 below.

Table 1: Definitions of the applications type

Item No	Application Type	Messages	Comments
1	CM		CM is an ATN service
2	AFN		AFN is a FANS 1/A service
3	CPDLC		All implemented up and downlink messages to be recorded
4	ADS-C	ADS-C reports	All contract requests and reports recorded
		Position reports	Only used within FANS 1/A. Mainly used in oceanic and remote areas.
5	ADS-B	Surveillance data	Information that enables correlation with any associated records stored separately from the helicopter.
6	D-FIS		D-FIS is an ATN service. All implemented up and downlink messages to be recorded
7	TWIP	TWIP messages	Terminal weather information for pilots
8	D ATIS	ATIS messages	Refer to EUROCAE ED-89A, dated December 2003: Data Link Application System Document (DLASD) for the 'ATIS' data link service
9	OCL	OCL messages	Refer to EUROCAE ED-106A, dated March 2004: Data Link Application System Document (DLASD) for 'Oceanic Clearance' (OCL) data link service
10	DCL	DCL messages	Refer to EUROCAE ED-85A, dated March 2003: Data Link Application System Document (DLASD) for 'Departure Clearance' data link service
11	Graphics	Weather maps & other graphics	Graphics exchanged in the framework of procedures within the operational control, as specified in Part-ORO.

Item No	Application Type	Messages	Comments
			Information that enables correlation with any associated records stored separately from the helicopter.
12	AOC	Aeronautical operational control messages	Messages exchanged in the framework of procedures within the operational control, as specified in Part-ORO. Information that enables correlation with any associated records stored separately from the helicopter. Definition in EUROCAE ED-112, dated March 2003.
13	Surveillance	Downlinked Aircraft Parameters (DAP)	As defined in ICAO Annex 10 Volume IV (Surveillance systems and ACAS).

AAC	aeronautical administrative communications
ADS-B	automatic dependent surveillance - broadcast
ADS-C	automatic dependent surveillance – contract
AFN	aircraft flight notification
AOC	aeronautical operational control
ATIS	automatic terminal information service
ATSC	air traffic service communication
CAP	controller access parameters
CPDLC	controller pilot data link communications
CM	configuration/context management
D-ATIS	digital ATIS
D-FIS	data link flight information service
D-METAR	data link meteorological airport report
DCL	departure clearance
FANS	Future Air Navigation System
FLIPCY	flight plan consistency
OCL	oceanic clearance
SAP	system access parameters
TWIP	terminal weather information for pilots

GM1 NCC.IDE.H.170(a) Data link recording

APPLICABILITY OF THE DATA LINK RECORDING REQUIREMENT

- (a) If it is certain that the helicopter cannot use data link communication messages for ATS communications corresponding to any application designated by NCC.IDE.H.170(a)(1), then the data link recording requirement does not apply.
- (b) Examples where the helicopter cannot use data link communication messages for ATS communications include but are not limited to the cases where:
 - (1) the helicopter data link communication capability is disabled permanently and in a way that it cannot be enabled again during the flight;
 - (2) data link communications are not used to support air traffic service (ATS) in the area of operation of the helicopter; and
 - (3) the helicopter data link communication equipment cannot communicate with the equipment used by ATS in the area of operation of the helicopter.

NCC.IDE.H.175 Flight data and cockpit voice combination recorder

Compliance with CVR and FDR requirements may be achieved by one flight data and cockpit voice combination recorder.

GM1 NCC.IDE.H.175 Flight data and cockpit voice combination recorder

COMBINATION RECORDERS

- (a) A flight data and cockpit voice combination recorder is a flight recorder that records:
 - (1) all voice communications and the aural environment required by NCC.IDE.H.160; and
 - (2) all parameters required by NCC.IDE.H.165,with the same specifications required by NCC.IDE.H.160 and NCC.IDE.H.165.
- (b) In addition, a flight data and cockpit voice combination recorder may record data link communication messages and related information required by the NCC.IDE.H.170.

NCC.IDE.H.180 Seats, seat safety belts, restraint systems and child restraint devices

- (a) Helicopters shall be equipped with:
- (1) a seat or berth for each person on board who is aged 24 months or more;
 - (2) a seat belt on each passenger seat and restraining belts for each berth;
 - (3) for helicopters first issued with an individual CofA after 31 December 2012, a seat belt with an upper torso restraint system for each passenger who is aged 24 months or more;
 - (4) a child restraint device (CRD) for each person on board younger than 24 months;
 - (5) a seat belt with upper torso restraint system incorporating a device that will automatically restrain the occupant's torso in the event of rapid deceleration on each flight crew seat; and
 - (6) a seat belt with upper torso restraint system on the seats for the minimum required cabin crew, in the case of helicopters first issued with an individual CofA after 31 December 1980.
- (b) A seat belt with upper torso restraint system shall:
- (1) have a single point release; and
 - (2) on flight crew seats, on any seat alongside a pilot's seat and on the seats for the minimum required cabin crew, include two shoulder straps and a seat belt that may be used independently.

AMC1 NCC.IDE.H.180 Seats, seat safety belts, restraint systems and child restraint devices

CHILD RESTRAINT DEVICES (CRDS)

- (a) A CRD is considered to be acceptable if:
- (1) it is a supplementary loop belt manufactured with the same techniques and the same materials of the approved safety belts; or
 - (2) it complies with (b).
- (b) Provided the CRD can be installed properly on the respective helicopter seat, the following CRDs are considered acceptable:
- (1) CRDs approved for use in aircraft by a competent authority on the basis of a technical standard and marked accordingly.
 - (2) CRDs approved for use in motor vehicles according to the UN standard ECE R 44, -03 or later series of amendments.
 - (3) CRDs approved for use in motor vehicles and aircraft according to Canadian CMVSS 213/213.1.
 - (4) CRDs approved for use in motor vehicles and aircraft according to US FMVSS No 213 and manufactured to these standards on or after February 26, 1985. US approved CRDs manufactured after this date should bear the following labels in red letters:
 - (i) 'THIS CHILD RESTRAINT SYSTEM CONFORMS TO ALL APPLICABLE FEDERAL MOTOR VEHICLE SAFETY STANDARDS'; and
 - (ii) 'THIS RESTRAINT IS CERTIFIED FOR USE IN MOTOR VEHICLES AND AIRCRAFT';
 - (5) CRDs qualified for use in aircraft according to the German 'Qualification Procedure for Child Restraint Systems for Use in Aircraft' (TÜV Doc.: TÜV/958-01/2001); and

- (6) Devices approved for use in cars, manufactured and tested to standards equivalent to those listed above. The device should be marked with an associated qualification sign, which shows the name of the qualification organisation and a specific identification number, related to the associated qualification project. The qualifying organisation should be a competent and independent organisation that is acceptable to the competent authority.
- (c) Location
- (1) Forward facing CRDs may be installed on both forward and rearward facing passenger seats but only when fitted in the same direction as the passenger seat on which they are positioned. Rearward facing CRDs should only be installed on forward facing passenger seats. A CRD may not be installed within the radius of action of an airbag, unless it is obvious that the airbag is de-activated or it can be demonstrated that there is no negative impact from the airbag.
 - (2) An infant in a CRD should be located as near to a floor level exit as feasible.
 - (3) An infant in a CRD should not hinder evacuation for any passenger.
 - (4) An infant in a CRD should neither be located in the row (where rows are existing) leading to an emergency exit nor located in a row immediately forward or aft of an emergency exit. A window passenger seat is the preferred location. An aisle passenger seat or a cross aisle passenger seat that forms part of the evacuation route to exits is not recommended. Other locations may be acceptable provided the access of neighbour passengers to the nearest aisle is not obstructed by the CRD.
 - (5) In general, only one CRD per row segment is recommended. More than one CRD per row segment is allowed if the infants are from the same family or travelling group provided the infants are accompanied by a responsible adult sitting next to them.
 - (6) A row segment is the fraction of a row separated by two aisles or by one aisle and the helicopter fuselage.
- (d) Installation
- (1) CRDs should only be installed on a suitable helicopter seat with the type of connecting device they are approved or qualified for. E.g., CRDs to be connected by a three point harness only (most rearward facing baby CRDs currently available) should not be attached to a helicopter seat with a lap belt only; a CRD designed to be attached to a vehicle seat by means of rigid bar lower anchorages (ISO-FIX or US equivalent) only, should only be used on helicopter seats that are equipped with such connecting devices and should not be attached by the helicopter seat lap belt. The method of connecting should be the one shown in the manufacturer's instructions provided with each CRD.
 - (2) All safety and installation instructions should be followed carefully by the responsible person accompanying the infant. Cabin crew should prohibit the use of any inadequately installed CRD or not qualified seat.
 - (3) If a forward facing CRD with a rigid backrest is to be fastened by a lap belt, the restraint device should be fastened when the backrest of the passenger seat on which it rests is in a reclined position. Thereafter, the backrest is to be positioned upright. This procedure ensures better tightening of the CRD on the aircraft seat if the aircraft seat is reclinable.
 - (4) The buckle of the adult safety belt should be easily accessible for both opening and closing, and should be in line with the seat belt halves (not canted) after tightening.
 - (5) Forward facing restraint devices with an integral harness should not be installed such that the adult safety belt is secured over the infant.

(e) Operation

- (1) Each CRD should remain secured to a passenger seat during all phases of flight, unless it is properly stowed when not in use.
- (2) Where a CRD is adjustable in recline, it should be in an upright position for all occasions when passenger restraint devices are required.

AMC2 NCC.IDE.H.180 Seats, seat safety belts, restraint systems and child restraint devices

UPPER TORSO RESTRAINT SYSTEM

An upper torso restraint system having three straps is deemed to be compliant with the requirement for restraint systems with two shoulder straps.

SAFETY BELT

A safety belt with a diagonal shoulder strap (three anchorage points) is deemed to be compliant with the requirement for safety belts (two anchorage points).

AMC3 NCC.IDE.H.180 Seats, seat safety belts, restraint systems and child restraint devices

SEATS FOR MINIMUM REQUIRED CABIN CREW

- (a) Seats for the minimum required cabin crew members should be located near required floor level emergency exits, except if the emergency evacuation of passengers would be enhanced by seating the cabin crew members elsewhere. In this case other locations are acceptable. This criterion should also apply if the number of required cabin crew members exceeds the number of floor level emergency exits.
- (b) Seats for cabin crew member(s) should be forward or rearward facing within 15° of the longitudinal axis of the helicopter.

NCC.IDE.H.185 Fasten seat belt and no smoking signs

Helicopters in which not all passenger seats are visible from the flight crew seat(s) shall be equipped with a means of indicating to all passengers and cabin crew when seat belts shall be fastened and when smoking is not allowed.

NCC.IDE.H.190 First-aid kit

- (a) Helicopters shall be equipped with at least one first-aid kit.
- (b) The first-aid kit(s) shall be:
 - (1) readily accessible for use; and
 - (2) kept up-to-date.

AMC1 NCC.IDE.H.190 First-aid kit

CONTENT OF FIRST-AID KIT

- (a) First-aid kits should be equipped with appropriate and sufficient medications and instrumentation. However, these kits should be amended by the operator according to the characteristics of the operation (scope of operation, flight duration, number and demographics of passengers, etc.).
- (b) The following should be included in the FAKs:
 - (1) Equipment:
 - (i) bandages (assorted sizes);
 - (ii) burns dressings (unspecified);
 - (iii) wound dressings (large and small);
 - (iv) adhesive dressings (assorted sizes);
 - (v) adhesive tape;
 - (vi) adhesive wound closures;
 - (vii) safety pins;
 - (viii) safety scissors;
 - (ix) antiseptic wound cleaner;
 - (x) disposable resuscitation aid;
 - (xi) disposable gloves;
 - (xii) tweezers: splinter; and
 - (xiii) thermometers (non-mercury).
 - (2) Medications:
 - (i) simple analgesic (may include liquid form);
 - (ii) antiemetic;
 - (iii) nasal decongestant;
 - (iv) gastrointestinal antacid, in the case of helicopters carrying more than nine passengers;

- (v) anti-diarrhoeal medication in the case of helicopters carrying more than nine passengers; and
 - (vi) antihistamine.
- (3) Other:
- (i) a list of contents in at least two languages (English and one other). This should include information on the effects and side effects of medications carried;
 - (ii) first-aid handbook;
 - (iii) medical incident report form; and
 - (iv) biohazard disposal bags.
- (4) An eye irrigator, although not required to be carried in the FAK, should, where possible, be available for use on the ground.

AMC2 NCC.IDE.H.190 First-aid kit

MAINTENANCE OF FIRST-AID KITS

To be kept up to date, first-aid kits should be:

- (a) inspected periodically to confirm, to the extent possible, that contents are maintained in the condition necessary for their intended use;
- (b) replenished at regular intervals, in accordance with instructions contained on their labels, or as circumstances warrant; and
- (c) replenished after use in-flight at the first opportunity where replacement items are available.

NCC.IDE.H.200 Supplemental oxygen — non-pressurised helicopters

- (a) Non-pressurised helicopters operated at flight altitudes when the oxygen supply is required in accordance with (b) shall be equipped with oxygen storage and dispensing apparatus capable of storing and dispensing the required oxygen supplies.
- (b) Non-pressurised helicopters operated above flight altitudes at which the pressure altitude in the passenger compartments is above 10 000 ft shall carry enough breathing oxygen to supply:
 - (1) all crew members and at least 10 % of the passengers for any period in excess of 30 minutes when the pressure altitude in the passenger compartment will be between 10 000 ft and 13 000 ft; and
 - (2) all crew members and passengers for any period that the pressure altitude in the passenger compartment will be above 13 000 ft.

AMC1 NCC.IDE.H.200 Supplemental oxygen — non-pressurised helicopters

DETERMINATION OF OXYGEN

The amount of supplemental oxygen required for a particular operation should be determined on the basis of flight altitudes and flight duration, consistent with the operating procedures, including emergency procedures, established for each operation and the routes to be flown as specified in the operations manual.

NCC.IDE.H.205 Hand fire extinguishers

- (a) Helicopters shall be equipped with at least one hand fire extinguisher:
 - (1) in the flight crew compartment; and
 - (2) in each passenger compartment that is separate from the flight crew compartment, except if the compartment is readily accessible to the flight crew.
- (b) The type and quantity of extinguishing agent for the required fire extinguishers shall be suitable for the type of fire likely to occur in the compartment where the extinguisher is intended to be used and to minimise the hazard of toxic gas concentration in compartments occupied by persons.

AMC1 NCC.IDE.H.205 Hand fire extinguishers

NUMBER, LOCATION AND TYPE

- (a) The number and location of hand fire extinguishers should be such as to provide adequate availability for use, account being taken of the number and size of the passenger compartments, the need to minimise the hazard of toxic gas concentrations and the location of toilets, galleys, etc. These considerations may result in the number of fire extinguishers being greater than the minimum required.
- (b) There should be at least one hand fire extinguisher installed in the flight crew compartment and this should be suitable for fighting both flammable fluid and electrical equipment fires. Additional hand fire extinguishers may be required for the protection of other compartments accessible to the crew in flight. Dry chemical fire extinguishers should not be used in the flight crew compartment, or in any compartment not separated by a partition from the flight crew compartment, because of the adverse effect on vision during discharge and, if conductive, interference with electrical contacts by the chemical residues.
- (c) Where only one hand fire extinguisher is required in the passenger compartments, it should be located near the cabin crew member's station, where provided.
- (d) Where two or more hand fire extinguishers are required in the passenger compartments and their location is not otherwise dictated by consideration of (a), an extinguisher should be located near each end of the cabin with the remainder distributed throughout the cabin as evenly as is practicable.
- (e) Unless an extinguisher is clearly visible, its location should be indicated by a placard or sign. Appropriate symbols may also be used to supplement such a placard or sign.

NCC.IDE.H.210 Marking of break-in points

If areas of the helicopter's fuselage suitable for break-in by rescue crews in an emergency are marked, such areas shall be marked as shown in Figure 1.

Figure 1

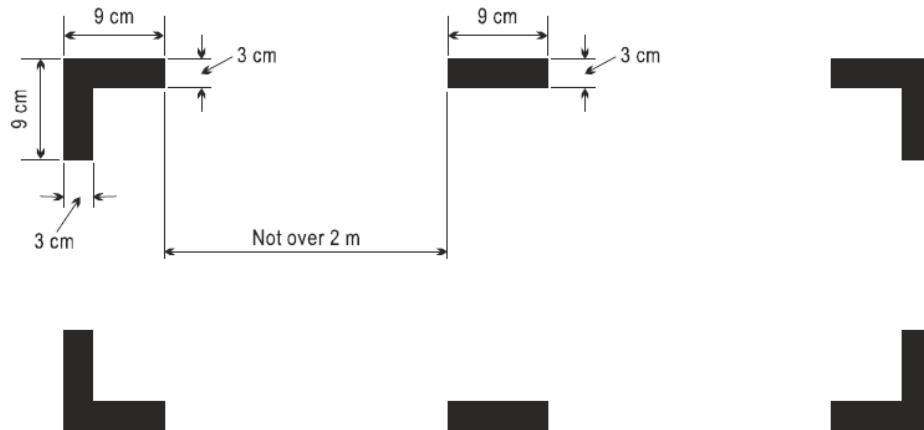
Marking of break-in points**AMC1 NCC.IDE.H.210 Marking of break-in points****MARKINGS – COLOUR AND CORNERS**

- (a) The colour of the markings should be red or yellow and, if necessary, should be outlined in white to contrast with the background.
- (b) If the corner markings are more than 2 m apart, intermediate lines 9 cm x 3 cm should be inserted so that there is no more than 2 m between adjacent markings.

NCC.IDE.H.215 Emergency locator transmitter (ELT)

- Grey text shall be applicable until 01 July 2018, then deleted
- (a) Helicopters shall be equipped with at least one automatic ELT.
 - (b) Helicopters operating on a flight over water in support of offshore operations in a hostile environment and at a distance from land corresponding to more than 10 minutes flying time at normal cruising speed, where in the case of the critical engine failure, the helicopter is able to sustain level flight, shall be equipped with an automatically deployable ELT (ELT(AD)).
 - (c) An ELT of any type shall be capable of transmitting simultaneously on 121,5 MHz and 406 MHz.

AMC1 NCC.IDE.H.215 Emergency locator transmitter (ELT)

ELT BATTERIES

Batteries used in the ELTs should be replaced (or recharged, if the battery is rechargeable) when the equipment has been in use for more than 1 cumulative hour, and also when 50% of their useful life (or for rechargeable, 50% of their useful life of charge), as established by the equipment manufacturer, has expired. The new expiry date for the replacement (or recharged) battery should be legibly marked on the outside of the equipment. The battery useful life (or useful life of charge) requirements of this paragraph do not apply to batteries (such as water-activated batteries) that are essentially unaffected during probable storage intervals.

AMC2 NCC.IDE.H.215 Emergency locator transmitter (ELT)

TYPES OF ELT AND GENERAL TECHNICAL SPECIFICATIONS

- (a) The ELT required by this provision should be one of the following:
 - (1) Automatic fixed (ELT(AF)). An automatically activated ELT that is permanently attached to an aircraft and is designed to aid SAR teams in locating the crash site.
 - (2) Automatic portable (ELT(AP)). An automatically activated ELT that is rigidly attached to an aircraft before a crash, but is readily removable from the aircraft after a crash. It functions as an ELT during the crash sequence. If the ELT does not employ an integral antenna, the aircraft-mounted antenna may be disconnected and an auxiliary antenna (stored on the ELT case) attached to the ELT. The ELT can be tethered to a survivor or a life-raft. This type of ELT is intended to aid SAR teams in locating the crash site or survivor(s).
 - (3) Automatic deployable (ELT(AD)). An ELT that is rigidly attached to the aircraft before the crash and that is automatically ejected, deployed and activated by an impact, and, in some cases, also by hydrostatic sensors. Manual deployment is also provided. This type of ELT should float in water and is intended to aid SAR teams in locating the crash site.
 - (4) Survival ELT (ELT(S)). An ELT that is removable from an aircraft, stowed so as to facilitate its ready use in an emergency, and manually activated by a survivor. An ELT(S) may be activated manually or automatically (e.g. by water activation). It should be designed either to be tethered to a life-raft or a survivor.
- (b) To minimise the possibility of damage in the event of crash impact, the automatic ELT should be rigidly fixed to the aircraft structure, as far aft as is practicable, with its antenna and connections arranged so as to maximise the probability of the signal being transmitted after a crash.
- (c) Any ELT carried should operate in accordance with the relevant provisions of ICAO Annex 10, Volume III and should be registered with the national agency responsible for initiating search and rescue or other nominated agency.

NCC.IDE.H.225 Life-jackets

- (a) Helicopters shall be equipped with a life-jacket for each person on board or equivalent individual floatation device for each person on board younger than 24 months, which shall be worn or stowed in a position that is readily accessible from the seat or berth of the person for whose use it is provided, when:
- (1) operated on a flight over water at a distance from land corresponding to more than 10 minutes flying time at normal cruising speed, where in the case of the critical engine failure, the helicopter is able to sustain level flight;
 - (2) operated on a flight over water beyond autorotational distance from the land, where in the case of critical engine failure, the helicopter is not able to sustain level flight; or
 - (3) taking off or landing at an aerodrome or operating site where the take-off or approach path is over water.
- (b) Each life-jacket or equivalent individual floatation device shall be equipped with a means of electric illumination for the purpose of facilitating the location of persons.

AMC1 NCC.IDE.H.225(a) Life-jackets

ACCESSIBILITY

The life-jacket should be accessible from the seat or berth of the person for whose use it is provided, with a safety belt or restraint system fastened.

AMC1 NCC.IDE.H.225(b) Life-jackets

ELECTRIC ILLUMINATION

The means of electric illumination should be a survivor locator light as defined in the applicable ETSO issued by the Agency or equivalent.

GM1 NCC.IDE.H.225 Life-jackets

SEAT CUSHIONS

Seat cushions are not considered to be flotation devices.

NCC.IDE.H.226 Crew survival suits

Each crew member shall wear a survival suit when:

- (a) operating on a flight over water in support of offshore operations, at a distance from land corresponding to more than 10 minutes flying time at normal cruising speed, where in the case of the critical engine failure, the helicopter is able to sustain level flight and when:
- (1) the weather report or forecasts available to the pilot-in-command indicate that the sea temperature will be less than plus 10 °C during the flight; or
 - (2) the estimated rescue time exceeds the estimated survival time;
- or
- (b) so determined by the pilot-in-command based on a risk assessment taking into account the following conditions:
- (1) flights over water beyond autorotational distance or safe forced landing distance from land, where in the case of the critical engine failure, the helicopter is not able to sustain level flight; and
 - (2) the weather report or forecasts available to the commander/pilot-in-command indicate that the sea temperature will be less than plus 10 °C during the flight.

Applicable until 01 July 2018, then replaced by the text below

NCC.IDE.H.226 Crew survival suits

Each crew member shall wear a survival suit when so determined by the pilot-in-command based on a risk assessment taking into account the following conditions:

- (a) flights over water beyond autorotational distance or safe forced landing distance from land, where in the case of a critical engine failure, the helicopter is not able to sustain level flight; and
- (b) the weather report or forecasts available to the commander/pilot-in-command indicate that the sea temperature will be less than plus 10 °C during the flight.

Applicable from 01 July 2018. Will replace the text above.

GM1 NCC.IDE.H.226 Crew survival suits**ESTIMATING SURVIVAL TIME**

- (a) Introduction
 - (1) A person accidentally immersed in cold seas (typically offshore Northern Europe) will have a better chance of survival if he/she is wearing an effective survival suit in addition to a life-jacket. By wearing the survival suit, he/she can slow down the rate which his/her body temperature falls and, consequently, protect himself/herself from the greater risk of drowning brought about by incapacitation due to hypothermia.
 - (2) The complete survival suit system — suit, life-jacket and clothes worn under the suit — should be able to keep the wearer alive long enough for the rescue services to find and recover him/her. In practice the limit is about 3 hours. If a group of persons in the water cannot be rescued within this time, they are likely to have become so scattered and separated that location will be extremely difficult, especially in the rough water typical of Northern European sea areas. If it is expected that in water protection could be required for periods greater than 3 hours, improvements should, rather, be sought in the search and rescue procedures than in the immersion suit protection.
- (b) Survival times

-
- (1) The aim should be to ensure that a person in the water can survive long enough to be rescued, i.e. the survival time should be greater than the likely rescue time. The factors affecting both times are shown in Figure 1. The figure emphasises that survival time is influenced by many factors, physical and human. Some of the factors are relevant to survival in cold water and some are relevant in water at any temperature.

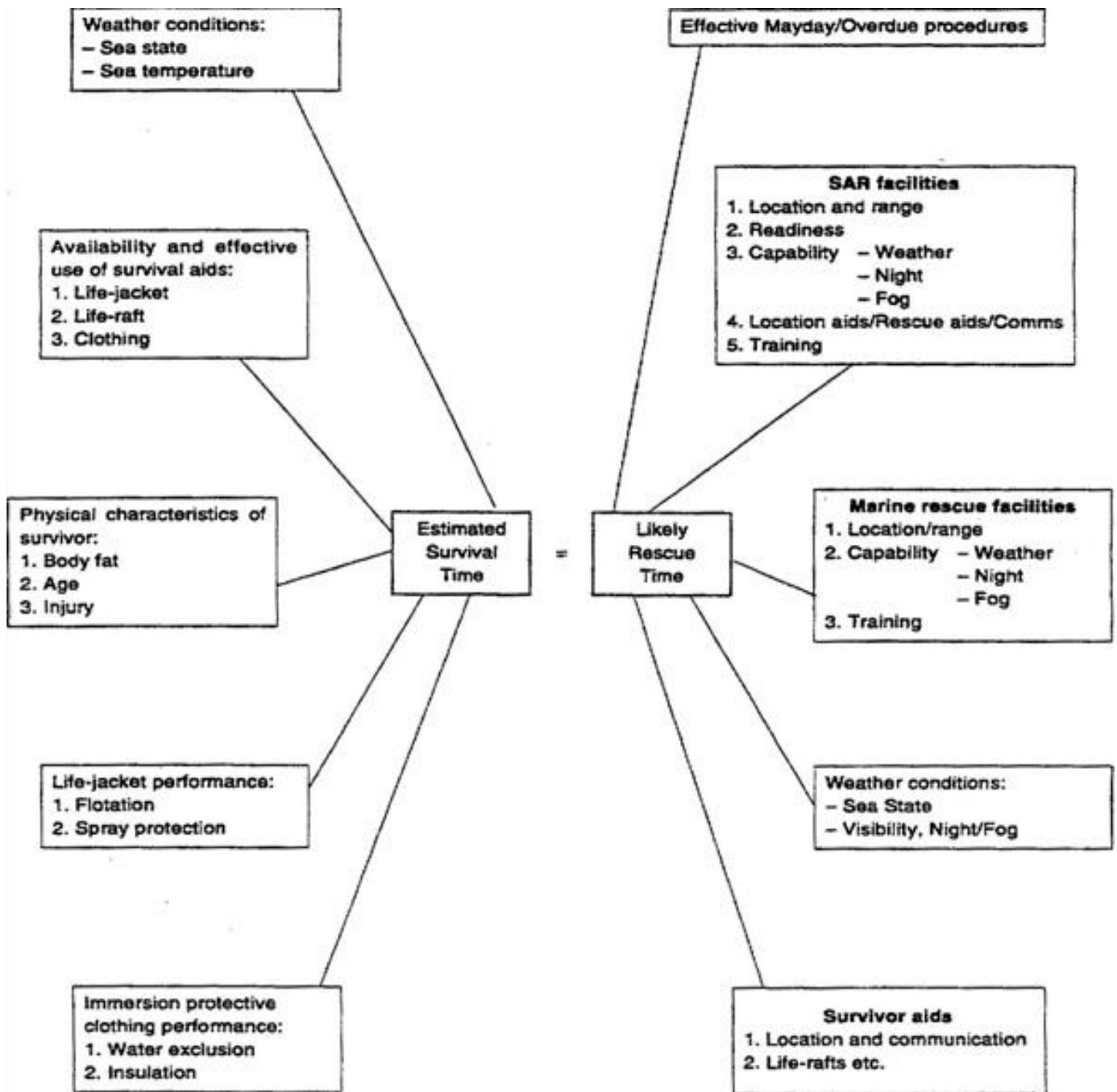

Figure 1: The survival equation

- (2) Broad estimates of likely survival times for the thin individual offshore are given in Table 1 below. As survival time is significantly affected by the prevailing weather conditions at the time of immersion, the Beaufort wind scale has been used as an indicator of these surface conditions.

Table 1: Timescale within which the most vulnerable individuals are likely to succumb to the prevailing conditions.

Clothing assembly	Beaufort wind force	Times within which the most vulnerable individuals are likely to drown	
		(water temp 5 °C)	(water temp 13 °C)
Working clothes (no immersion suit)	0 – 2	Within ¾ hour	Within 1 ¼ hours
	3 – 4	Within ½ hour	Within ½ hour
	5 and above	Significantly less than ½ hour	Significantly less than ½ hour
Immersion suit worn over working clothes (with leakage inside suit)	0 – 2	May well exceed 3 hours	May well exceed 3 hours
	3 – 4	Within 2 ¾ hours	May well exceed 3 hours
	5 and above	Significantly less than 2 ¾ hours. May well exceed 1 hour	May well exceed 3 hours

- (3) Consideration should also be given to escaping from the helicopter itself should it submerge or invert in the water. In this case, escape time is limited to the length of time the occupants can hold their breath. The breath holding time can be greatly reduced by the effect of cold shock. Cold shock is caused by the sudden drop in skin temperature on immersion, and is characterised by a gasp reflex and uncontrolled breathing. The urge to breath rapidly becomes overwhelming and, if still submerged, the individual will inhale water resulting in drowning. Delaying the onset of cold shock by wearing an immersion suit will extend the available escape time from a submerged helicopter.
- (4) The effects of water leakage and hydrostatic compression on the insulation quality of clothing are well recognised. In a nominally dry system the insulation is provided by still air trapped within the clothing fibres and between the layers of suit and clothes. It has been observed that many systems lose some of their insulating capacity either because the clothes under the 'waterproof' survival suit get wet to some extent or because of hydrostatic compression of the whole assembly. As a result of water leakage and compression, survival times will be shortened. The wearing of warm clothing under the suit is recommended.
- (5) Whatever type of survival suit and other clothing is provided, it should not be forgotten that significant heat loss can occur from the head.

NCC.IDE.H.227 Life-rafts, survival ELTs and survival equipment on extended overwater flights

Helicopters operated:

- (a) on a flight over water at a distance from land corresponding to more than 10 minutes flying time at normal cruising speed, where in the case of the critical engine failure, the helicopter is able to sustain level flight; or
- (b) on a flight over water at a distance corresponding to more than 3 minutes flying time at normal cruising speed, where in the case of the critical engine failure, the helicopter is not able to sustain level flight, and if so determined by the pilot-in-command by means of a risk assessment;

shall be equipped with:

- (1) in the case of a helicopter carrying less than 12 persons, at least one life-raft with a rated capacity of not less than the maximum number of persons on board, stowed so as to facilitate their ready use in emergency;
- (2) in the case of a helicopter carrying more than 11 persons, at least two life-rafts, stowed so as to facilitate their ready use in an emergency, sufficient together to accommodate all persons capable of being carried on board and, if one is lost the remaining life-raft(s) having the overload capacity sufficient to accommodate all persons on the helicopter;
- (3) at least one survival ELT (ELT(S)) for each required life-raft; and
- (4) life-saving equipment, including means of sustaining life, as appropriate to the flight to be undertaken.

AMC1 NCC.IDE.H.227 Life-rafts, survival ELTs and survival equipment on extended overwater flights**LIFE-RAFTS AND EQUIPMENT FOR MAKING DISTRESS SIGNALS**

- (a) Each required life-raft should conform to the following specifications:
 - (1) be of an approved design and stowed so as to facilitate their ready use in an emergency;
 - (2) be radar conspicuous to standard airborne radar equipment;
 - (3) when carrying more than one life-raft on board, at least 50 % of the rafts should be able to be deployed by the crew while seated at their normal station, where necessary by remote control; and
 - (4) life-rafts that are not deployable by remote control or by the crew should be of such weight as to permit handling by one person. 40 kg should be considered a maximum weight.
- (b) Each required life-raft should contain at least the following:
 - (1) one approved survivor locator light;
 - (2) one approved visual signalling device;
 - (3) one canopy (for use as a sail, sunshade or rain catcher) or other means to protect occupants from the elements;
 - (4) one radar reflector;
 - (5) one 20 m retaining line designed to hold the life-raft near the helicopter but to release it if the helicopter becomes totally submerged;
 - (6) one sea anchor; and

-
- (7) one survival kit, appropriately equipped for the route to be flown, which should contain at least the following:
- (i) one life-raft repair kit;
 - (ii) one bailing bucket;
 - (iii) one signalling mirror;
 - (iv) one police whistle;
 - (v) one buoyant raft knife;
 - (vi) one supplementary means of inflation;
 - (vii) sea sickness tablets;
 - (viii) one first-aid kit;
 - (ix) one portable means of illumination;
 - (x) 500 ml of pure water and one sea water desalting kit; and
 - (xi) one comprehensive illustrated survival booklet in an appropriate language.

NCC.IDE.H.230 Survival equipment

Helicopters operated over areas in which search and rescue would be especially difficult shall be equipped with:

- (a) signalling equipment to make distress signals;
- (b) at least one survival ELT (ELT(S)); and
- (c) additional survival equipment for the route to be flown taking account of the number of persons on board.

AMC1 NCC.IDE.H.230 Survival equipment

ADDITIONAL SURVIVAL EQUIPMENT

- (a) The following additional survival equipment should be carried when required:
 - (1) 500 ml of water for each four, or fraction of four, persons on board;
 - (2) one knife;
 - (3) first-aid equipment; and
 - (4) one set of air/ground codes.
- (b) In addition, when polar conditions are expected, the following should be carried:
 - (1) a means of melting snow;
 - (2) one snow shovel and one ice saw;
 - (3) sleeping bags for use by 1/3 of all persons on board and space blankets for the remainder or space blankets for all passengers on board; and
 - (4) one arctic/polar suit for each crew member carried.
- (c) If any item of equipment contained in the above list is already carried on board the aircraft in accordance with another requirement, there is no need for this to be duplicated.

AMC2 NCC.IDE.H.230 Survival equipment

SURVIVAL ELT

An ELT(AP) may be used to replace one required ELT(S) provided that it meets the ELT(S) requirements. A water-activated ELT(S) is not an ELT(AP).

GM1 NCC.IDE.H.230 Survival equipment

SIGNALLING EQUIPMENT

The signalling equipment for making distress signals is described in ICAO Annex 2, Rules of the Air.

GM2 NCC.IDE.H.230 Survival equipment

AREAS IN WHICH SEARCH AND RESCUE WOULD BE ESPECIALLY DIFFICULT

The expression 'areas in which search and rescue would be especially difficult' should be interpreted, in this context, as meaning:

- (a) areas so designated by the competent authority responsible for managing search and rescue; or

-
- (b) areas that are largely uninhabited and where:
- (1) the authority referred to in (a) has not published any information to confirm whether search and rescue would be or would not be especially difficult; and
 - (2) the authority referred to in (a) does not, as a matter of policy, designate areas as being especially difficult for search and rescue.

NCC.IDE.H.231 Additional requirements for helicopters conducting offshore operations in a hostile sea area

Helicopters operated in offshore operations in a hostile sea area, at a distance from land corresponding to more than 10 minutes flying time at normal cruising speed, shall comply with the following:

- (a) When the weather report or forecasts available to the pilot-in-command indicate that the sea temperature will be less than plus 10 °C during the flight, or when the estimated rescue time exceeds the calculated survival time, or the flight is planned to be conducted at night, all persons on board are wearing a survival suit.
- (b) All life-rafts carried in accordance with NCC.IDE.H.227 shall be installed so as to be usable in the sea conditions in which the helicopter's ditching, flotation and trim characteristics were evaluated in order to comply with the ditching requirements for certification.
- (c) The helicopter shall be equipped with an emergency lighting system with an independent power supply to provide a source of general cabin illumination to facilitate the evacuation of the helicopter.
- (d) All emergency exits, including crew emergency exits, and the means of opening them shall be conspicuously marked for the guidance of occupants using the exits in daylight or in the dark. Such markings shall be designed to remain visible if the helicopter is capsized and the cabin is submerged.
- (e) All non-jettisonable doors that are designated as ditching emergency exits shall have a means of securing them in the open position so that they do not interfere with occupants' egress in all sea conditions up to the maximum required to be evaluated for ditching and flotation.
- (f) All doors, windows or other openings in the passenger compartment intended to be used for the purpose of underwater escape shall be equipped so as to be operable in an emergency.
- (g) Life-jackets shall be worn at all times, unless the passenger or crew member is wearing an integrated survival suit that meets the combined requirement of the survival suit and life-jacket.

AMC1 NCC.IDE.H.231 Additional requirements for helicopters conducting offshore operations in a hostile sea area**INSTALLATION OF THE LIFE-RAFT**

- (a) Projections on the exterior surface of the helicopter that are located in a zone delineated by boundaries that are 1.22 m (4 ft) above and 0.61 m (2 ft) below the established static water line could cause damage to a deployed life-raft. Examples of projections which need to be considered are aerials, overboard vents, unprotected split-pin tails, guttering and any projection sharper than a three dimensional right angled corner.
- (b) While the boundaries specified in (a) are intended as a guide, the total area that should be considered should also take into account the likely behaviour of the life-raft after deployment in all sea states up to the maximum in which the helicopter is capable of remaining upright.
- (c) Wherever a modification or alteration is made to a helicopter within the boundaries specified, the need to prevent the modification or alteration from causing damage to a deployed life-raft should be taken into account in the design.
- (d) Particular care should also be taken during routine maintenance to ensure that additional hazards are not introduced by, for example, leaving inspection panels with sharp corners proud of the surrounding fuselage surface, or allowing door sills to deteriorate to a point where sharp edges become a hazard.

NCC.IDE.H.232 Helicopters certified for operating on water — miscellaneous equipment

Helicopters certified for operating on water shall be equipped with:

- (a) a sea anchor and other equipment necessary to facilitate mooring, anchoring or manoeuvring the helicopter on water, appropriate to its size, weight and handling characteristics; and
- (b) equipment for making the sound signals prescribed in the International Regulations for Preventing Collisions at Sea, where applicable.

GM1 NCC.IDE.H.232 Helicopters certificated for operating on water — Miscellaneous equipment**INTERNATIONAL REGULATIONS FOR PREVENTING COLLISIONS AT SEA**

International Regulations for Preventing Collisions at Sea are those that were published by the International Maritime Organisation (IMO) in 1972.

NCC.IDE.H.235 All helicopters on flights over water — ditching

Helicopters shall be designed for landing on water or certified for ditching in accordance with the relevant airworthiness code or fitted with emergency flotation equipment when operated on a flight over water in a hostile environment at a distance from land corresponding to more than 10 minutes flying time at normal cruising speed.

AMC1 NCC.IDE.H.235 All helicopters on flight over water — ditching

The same considerations of AMC1 NCC.IDE.H.231 should apply in respect of emergency flotation equipment AMC1 NCC.IDE.H.240 Headset

The considerations of AMC1 SPA.HOFO.165(d) should apply in respect of emergency flotation equipment.

GENERAL

- (a) A headset consists of a communication device that includes two earphones to receive and a microphone to transmit audio signals to the helicopter's communication system. To comply with the minimum performance requirements, the earphones and microphone should match the communication system's characteristics and the flight crew compartment environment. The headset should be adequately adjustable in order to fit the flight crew's head. Headset boom microphones should be of the noise cancelling type.
- (b) If the intention is to utilise noise cancelling earphones, the operator should ensure that the earphones do not attenuate any aural warnings or sounds necessary for alerting the flight crew on matters related to the safe operation of the helicopter.

The grey text is applicable until 01 July 2018, then replaced by the text in bold, below it.

NCC.IDE.H.240 Headset

Whenever a radio communication and/or radio navigation system is required, helicopters shall be equipped with a headset with boom microphone or equivalent and a transmit button on the flight controls for each required pilot and/or crew member at his/her assigned station.

GM1 NCC.IDE.H.240 Headset

GENERAL

The term 'headset' includes any aviation helmet incorporating headphones and microphone worn by a flight crew member.

NCC.IDE.H.245 Radio communication equipment

- (a) Helicopters operated under IFR or at night, or when required by the applicable airspace requirements, shall be equipped with radio communication equipment that, under normal radio propagating conditions, shall be capable of:
 - (1) conducting two-way communication for aerodrome control purposes;
 - (2) receiving meteorological information;
 - (3) conducting two-way communication at any time during flight with those aeronautical stations and on those frequencies prescribed by the appropriate authority; and
 - (4) providing for communication on the aeronautical emergency frequency 121,5 MHz.
- (b) When more than one communications equipment unit is required, each shall be independent of the other or others to the extent that a failure in any one will not result in failure of any other.
- (c) When a radio communication system is required, and in addition to the flight crew interphone system required in NCC.IDE.H.155, helicopters shall be equipped with a transmit button on the flight controls for each required pilot and crew member at his/her assigned station.

GM1 NCC.IDE.H.245 Radio communication equipment**APPLICABLE AIRSPACE REQUIREMENTS**

For helicopters being operated under European air traffic control, the applicable airspace requirements include the Single European Sky legislation.

NCC.IDE.H.250 Navigation equipment

- (a) Helicopters shall be equipped with navigation equipment that will enable them to proceed in accordance with:
 - (1) the ATS flight plan, if applicable; and
 - (2) the applicable airspace requirements.
- (b) Helicopters shall have sufficient navigation equipment to ensure that, in the event of the failure of one item of equipment at any stage of the flight, the remaining equipment shall allow safe navigation in accordance with (a), or an appropriate contingency action, to be completed safely.
- (c) Helicopters operated on flights in which it is intended to land in IMC shall be equipped with navigation equipment capable of providing guidance to a point from which a visual landing can be performed. This equipment shall be capable of providing such guidance for each aerodrome at which it is intended to land in IMC and for any designated alternate aerodromes.
- (d) When PBN is required the aircraft shall meet the airworthiness certification requirements for the appropriate navigation specification.

GM1 NCC.IDE.H.250 Navigation equipment

AIRCRAFT ELIGIBILITY FOR PBN SPECIFICATION NOT REQUIRING SPECIFIC APPROVAL

- (a) The performance of the aircraft is usually stated in the AFM.
- (b) Where such a reference cannot be found in the AFM, other information provided by the aircraft manufacturer as TC holder, the STC holder or the design organisation having a privilege to approve minor changes may be considered.
- (c) The following documents are considered acceptable sources of information:
 - (1) AFM, supplements thereto and documents directly referenced in the AFM;
 - (2) FCOM or similar document;
 - (3) Service Bulletin or Service Letter issued by the TC holder or STC holder;
 - (4) approved design data or data issued in support of a design change approval;
 - (5) any other formal document issued by the TC or STC holders stating compliance with PBN specifications, AMC, Advisory Circulars (AC) or similar documents issued by the State of Design; and
 - (6) written evidence obtained from the State of Design.
- (d) Equipment qualification data, in itself, is not sufficient to assess the PBN capabilities of the aircraft, since the latter depend on installation and integration.
- (e) As some PBN equipment and installations may have been certified prior to the publication of the PBN Manual and the adoption of its terminology for the navigation specifications, it is not always possible to find a clear statement of aircraft PBN capability in the AFM. However, aircraft eligibility for certain PBN specifications can rely on the aircraft performance certified for PBN procedures and routes prior to the publication of the PBN Manual.
- (f) Below, various references are listed which may be found in the AFM or other acceptable documents (see listing above) in order to consider the aircraft's eligibility for a specific PBN specification if the specific term is not used.
- (g) RNAV 5

-
- (1) If a statement of compliance with any of the following specifications or standards is found in the acceptable documentation as listed above, the aircraft is eligible for RNAV 5 operations.
- (i) B-RNAV;
 - (ii) RNAV 1;
 - (iii) RNP APCH;
 - (iv) RNP 4;
 - (v) A-RNP;
 - (vi) AMC 20-4;
 - (vii) JAA TEMPORARY GUIDANCE MATERIAL, LEAFLET NO. 2 (TGL 2);
 - (viii) JAA AMJ 20X2;
 - (ix) FAA AC 20-130A for en route operations;
 - (x) FAA AC 20-138 for en route operations; and
 - (xi) FAA AC 90-96.
- (h) RNAV 1/RNAV 2
- (1) If a statement of compliance with any of the following specifications or standards is found in the acceptable documentation as listed above, the aircraft is eligible for RNAV 1/RNAV 2 operations.
- (i) RNAV 1;
 - (ii) PRNAV;
 - (iii) US RNAV type A;
 - (iv) FAA AC 20-138 for the appropriate navigation specification;
 - (v) FAA AC 90-100A;
 - (vi) JAA TEMPORARY GUIDANCE MATERIAL, LEAFLET NO. 10 Rev1 (TGL 10); and
 - (vii) FAA AC 90-100.
- (2) However, if position determination is exclusively computed based on VOR-DME, the aircraft is not eligible for RNAV 1/RNAV 2 operations.
- (i) RNP 1/RNP 2 continental
- (1) If a statement of compliance with any of the following specifications or standards is found in the acceptable documentation as listed above, the aircraft is eligible for RNP 1/RNP 2 continental operations.
- (i) A-RNP;
 - (ii) FAA AC 20-138 for the appropriate navigation specification; and
 - (iii) FAA AC 90-105.
- (2) Alternatively, if a statement of compliance with any of the following specifications or standards is found in the acceptable documentation as listed above and position determination is primarily based on GNSS, the aircraft is eligible for RNP 1/RNP 2 continental operations. However, in these cases, loss of GNSS implies loss of RNP 1/RNP 2 capability.

-
- (i) JAA TEMPORARY GUIDANCE MATERIAL, LEAFLET NO. 10 (TGL 10) (any revision); and
 - (ii) FAA AC 90-100.
- (j) RNP APCH — LNAV minima
- (1) If a statement of compliance with any of the following specifications or standards is found in the acceptable documentation as listed above, the aircraft is eligible for RNP APCH — LNAV operations.
 - (i) A-RNP;
 - (ii) AMC 20-27;
 - (iii) AMC 20-28;
 - (iv) FAA AC 20-138 for the appropriate navigation specification; and
 - (v) FAA AC 90-105 for the appropriate navigation specification.
 - (2) Alternatively, if a statement of compliance with RNP 0.3 GNSS approaches in accordance with any of the following specifications or standards is found in the acceptable documentation as listed above, the aircraft is eligible for RNP APCH — LNAV operations. Any limitation such as ‘within the US National Airspace’ may be ignored since RNP APCH procedures are assumed to meet the same ICAO criteria around the world.
 - (i) JAA TEMPORARY GUIDANCE MATERIAL, LEAFLET NO. 3 (TGL 3);
 - (ii) AMC 20-4;
 - (iii) FAA AC 20-130A; and
 - (iv) FAA AC 20-138.
- (k) RNP APCH — LNAV/VNAV minima
- (1) If a statement of compliance with any of the following specifications or standards is found in the acceptable documentation as listed above, the aircraft is eligible for RNP APCH — LNAV/VNAV operations.
 - (i) A-RNP;
 - (ii) AMC 20-27 with Baro VNAV;
 - (iii) AMC 20-28;
 - (iv) FAA AC 20-138; and
 - (v) FAA AC 90-105 for the appropriate navigation specification.
 - (2) Alternatively, if a statement of compliance with FAA AC 20-129 is found in the acceptable documentation as listed above, and the aircraft complies with the requirements and limitations of EASA SIB 2014-04⁶, the aircraft is eligible for RNP APCH — LNAV/VNAV operations. Any limitation such as ‘within the US National Airspace’ may be ignored since RNP APCH procedures are assumed to meet the same ICAO criteria around the world.
- (l) RNP APCH — LPV minima

⁶ <http://ad.easa.europa.eu/ad/2014-04>

-
- (1) If a statement of compliance with any of the following specifications or standards is found in the acceptable documentation as listed above, the aircraft is eligible for RNP APCH — LPV operations.
 - (i) AMC 20-28;
 - (ii) FAA AC 20-138 for the appropriate navigation specification; and
 - (iii) FAA AC 90-107.
 - (2) For aircraft that have a TAWS Class A installed and do not provide Mode-5 protection on an LPV approach, the DH is limited to 250 ft.
- (m) RNAV 10
- (1) If a statement of compliance with any of the following specifications or standards is found in the acceptable documentation as listed above, the aircraft is eligible for RNAV 10 operations.
 - (i) RNP 10;
 - (ii) FAA AC 20-138 for the appropriate navigation specification;
 - (iii) AMC 20-12;
 - (iv) FAA Order 8400.12 (or later revision); and
 - (v) FAA AC 90-105.
- (n) RNP 4
- (1) If a statement of compliance with any of the following specifications or standards is found in the acceptable documentation as listed above, the aircraft is eligible for RNP 4 operations.
 - (i) FAA AC 20-138B or later, for the appropriate navigation specification;
 - (ii) FAA Order 8400.33; and
 - (iii) FAA AC 90-105 for the appropriate navigation specification.
- (o) RNP 2 oceanic
- (1) If a statement of compliance with FAA AC 90-105 for the appropriate navigation specification is found in the acceptable documentation as listed above, the aircraft is eligible for RNP 2 oceanic operations.
 - (2) If the aircraft has been assessed eligible for RNP 4, the aircraft is eligible for RNP 2 oceanic.
- (p) Special features
- (1) RF in terminal operations (used in RNP 1 and in the initial segment of the RNP APCH)
 - (i) If a statement of demonstrated capability to perform an RF leg, certified in accordance with any of the following specifications or standards, is found in the acceptable documentation as listed above, the aircraft is eligible for RF in terminal operations.
 - (A) AMC 20-26; and
 - (B) FAA AC 20-138B or later.
 - (ii) If there is a reference to RF and a reference to compliance with AC 90-105, then the aircraft is eligible for such operations.

- (q) Other considerations
- (1) In all cases, the limitations in the AFM need to be checked, in particular the use of AP or FD which can be required to reduce the FTE primarily for RNP APCH, RNAV 1, and RNP 1.
 - (2) Any limitation such as ‘within the US National Airspace’ may be ignored since RNP APCH procedures are assumed to meet the same ICAO criteria around the world.

GM2 NCC.IDE.H.250 Navigation equipment

GENERAL

- (a) The PBN specifications for which the aircraft complies with the relevant airworthiness criteria are set out in the AFM, together with any limitations to be observed.
- (b) Because functional and performance requirements are defined for each navigation specification, an aircraft approved for an RNP specification is not automatically approved for all RNAV specifications. Similarly, an aircraft approved for an RNP or RNAV specification having a stringent accuracy requirement (e.g. RNP 0.3 specification) is not automatically approved for a navigation specification having a less stringent accuracy requirement (e.g. RNP 4).

RNP 4

- (c) For RNP 4, at least two LRNSs, capable of navigating to RNP 4, and listed in the AFM, may be operational at the entry point of the RNP 4 airspace. If an item of equipment required for RNP 4 operations is unserviceable, then the flight crew may consider an alternate route or diversion for repairs. For multi-sensor systems, the AFM may permit entry if one GNSS sensor is lost after departure, provided one GNSS and one inertial sensor remain available.

NCC.IDE.H.255 Transponder

Helicopters shall be equipped with a pressure altitude reporting secondary surveillance radar (SSR) transponder and any other SSR transponder capability required for the route being flown.

AMC1 NCC.IDE.H.255 Transponder

SSR TRANSPONDER

- (a) The secondary surveillance radar (SSR) transponders of helicopters being operated under European air traffic control should comply with any applicable Single European Sky legislation.
- (b) If the Single European Sky legislation is not applicable, the SSR transponders should operate in accordance with the relevant provisions of Volume IV of ICAO Annex 10.

Applicable
from 01
January
2019

NCC.IDE.H.260 Management of aeronautical databases

- (a) Aeronautical databases used on certified aircraft system applications shall meet data quality requirements that are adequate for the intended use of the data.
- (b) The operator shall ensure the timely distribution and insertion of current and unaltered aeronautical databases to all aircraft that require them.
- (c) Notwithstanding any other occurrence reporting requirements as defined in Regulation (EU) No 376/2014, the operator shall report to the database provider instances of erroneous, inconsistent or missing data that might be reasonably expected to constitute a hazard to flight.

In such cases, the operator shall inform flight crew and other personnel concerned, and shall ensure that the affected data is not used.

ANNEX VII

Non-Commercial Air Operations with Other-Than Complex Motor-Powered Aircraft [PART-NCO]

SUBPART A: GENERAL REQUIREMENTS

NCO.GEN.100 Competent authority

- (a) The competent authority shall be the authority designated by the Member State where the aircraft is registered.
- (b) If the aircraft is registered in a third country, the competent authority shall be the authority designated by the Member State where the operator is established or residing.

NCO.GEN.101 Means of compliance

Alternative means of compliance to those adopted by the Agency may be used by an operator to establish compliance with Regulation (EC) No 216/2008 and its Implementing Rules.

NCO.GEN.102 Touring motor gliders, powered sailplanes and mixed balloons

- (a) Touring motor gliders shall be operated following the requirements for:
 - (1) aeroplanes when they are power-driven by an engine; and
 - (2) sailplanes when operated without using an engine.
- (b) Touring motor gliders shall be equipped in compliance with the requirements applicable to aeroplanes unless otherwise specified in Subpart D.
- (c) Powered sailplanes, excluding touring motor gliders, shall be operated and equipped in compliance with the requirements applicable to sailplanes.
- (d) Mixed balloons shall be operated in accordance with the requirements for hot-air balloons.

NCO.GEN.103 Introductory flights

Introductory flights referred to in Article 6(4a)(c) of this Regulation when conducted in accordance with this Annex, shall:

- (a) start and end at the same aerodrome or operating site, except for balloons and sailplanes;
- (b) be operated under VFR by day;
- (c) be overseen by a nominated person responsible for their safety; and
- (d) comply with any other conditions stipulated by the competent authority.

NCO.GEN.105 Pilot-in-command responsibilities and authority

- (a) The pilot-in-command shall be responsible for:
- (1) the safety of the aircraft and of all crew members, passengers and cargo on board during aircraft operations as referred to in 1.c of Annex IV to Regulation (EC) No 216/2008;
 - (2) the initiation, continuation, termination or diversion of a flight in the interest of safety;
 - (3) ensuring that all operational procedures and checklists are complied with as referred to in 1.b of Annex IV to Regulation (EC) No 216/2008;
 - (4) only commencing a flight if he/she is satisfied that all operational limitations referred to in 2.a.3 of Annex IV to Regulation (EC) No 216/2008 are complied with, as follows:
 - (i) the aircraft is airworthy;
 - (ii) the aircraft is duly registered;
 - (iii) instruments and equipment required for the execution of that flight are installed in the aircraft and are operative, unless operation with inoperative equipment is permitted by the minimum equipment list (MEL) or equivalent document, if applicable, as provided for in NCO.IDE.A.105, NCO.IDE.H.105, NCO.IDE.S.105 or NCO.IDE.B.105;
 - (iv) the mass of the aircraft and, except in the case of balloons, the centre of gravity location are such that the flight can be conducted within limits prescribed in the airworthiness documentation;
 - (v) all equipment, baggage and cargo are properly loaded and secured and an emergency evacuation remains possible;
 - (vi) the aircraft operating limitations as specified in the aircraft flight manual (AFM) will not be exceeded at any time during the flight; and
 - (vii) any navigational database required for PBN is suitable and current;
 - (5) not commencing a flight if he/she is incapacitated from performing duties by any cause such as injury, sickness, fatigue or the effects of any psychoactive substance;
 - (6) not continuing a flight beyond the nearest weather-permissible aerodrome or operating site when his/her capacity to perform duties is significantly reduced from causes such as fatigue, sickness or lack of oxygen;
 - (7) deciding on acceptance of the aircraft with unserviceabilities in accordance with the configuration deviation list (CDL) or minimum equipment list (MEL), as applicable; and
 - (8) recording utilisation data and all known or suspected defects in the aircraft at the termination of the flight, or series of flights, in the aircraft technical log or journey log for the aircraft.
- (b) The pilot-in-command shall ensure that during critical phases of flight or whenever deemed necessary in the interest of safety, all crew members are seated at their assigned stations and do not perform any activities other than those required for the safe operation of the aircraft.
- (c) The pilot-in-command shall have the authority to refuse carriage of or disembark any person, baggage or cargo that may represent a potential hazard to the safety of the aircraft or its occupants.

- (d) The pilot-in-command shall, as soon as possible, report to the appropriate air traffic services (ATS) unit any hazardous weather or flight conditions encountered that are likely to affect the safety of other aircraft.
- (e) The pilot-in-command shall, in an emergency situation that requires immediate decision and action, take any action he/she considers necessary under the circumstances in accordance with 7.d of Annex IV to Regulation (EC) No 216/2008. In such cases he/she may deviate from rules, operational procedures and methods in the interest of safety.
- (f) During flight, the pilot-in-command shall:
 - (1) except for balloons, keep his/her safety belt fastened while at his/her station; and
 - (2) remain at the controls of the aircraft at all times except if another pilot is taking the controls.
- (g) The pilot-in-command shall submit a report of an act of unlawful interference without delay to the competent authority and shall inform the designated local authority.
- (h) The pilot-in-command shall notify the nearest appropriate authority by the quickest available means of any accident involving the aircraft that results in serious injury or death of any person or substantial damage to the aircraft or property.

AMC1 NCO.GEN.105 Pilot-in-command responsibilities and authority

FLIGHT PREPARATION FOR PBN OPERATIONS

- (a) The pilot-in-command should ensure that RNAV 1, RNAV 2, RNP 1, RNP 2, and RNP APCH routes or procedures to be used for the intended flight, including for any alternate aerodromes, are selectable from the navigation database and are not prohibited by NOTAM.
- (b) The pilot-in-command should take account of any NOTAMs or pilot-in-command briefing material that could adversely affect the aircraft system operation along its flight plan including any alternate aerodromes.
- (c) When PBN relies on GNSS systems for which RAIM is required for integrity, its availability should be verified during the preflight planning. In the event of a predicted continuous loss of fault detection of more than five minutes, the flight planning should be revised to reflect the lack of full PBN capability for that period.
- (d) For RNP 4 operations with only GNSS sensors, a fault detection and exclusion (FDE) check should be performed. The maximum allowable time for which FDE capability is projected to be unavailable on any one event is 25 minutes. If predictions indicate that the maximum allowable FDE outage will be exceeded, the operation should be rescheduled to a time when FDE is available.
- (e) For RNAV 10 operations, the pilot-in-command should take account of the RNAV 10 time limit declared for the inertial system, if applicable, considering also the effect of weather conditions that could affect flight duration in RNAV 10 airspace. Where an extension to the time limit is permitted, the pilot-in-command will need to ensure that en route radio facilities are serviceable before departure, and to apply radio updates in accordance with any AFM/POH limitation.

AMC2 NCO.GEN.105 Pilot-in-command responsibilities and authority

DATABASE SUITABILITY

- (a) The pilot-in-command should check that any navigational database required for PBN operations includes the routes and procedures required for the flight.

DATABASE CURRENCY

- (b) The database validity (current AIRAC cycle) should be checked before the flight.
- (c) Navigation databases should be current for the duration of the flight. If the AIRAC cycle is due to change during flight, the pilot-in-command should follow procedures established by the pilot-in-command to ensure the accuracy of navigation data, including the suitability of navigation facilities used to define the routes and procedures for the flight.
- (d) An expired database may only be used if the following conditions are satisfied:
- (1) the pilot-in-command has confirmed that the parts of the database which are intended to be used during the flight and any contingencies that are reasonable to expect are not changed in the current version;
 - (2) any NOTAMs associated with the navigational data are taken into account;
 - (3) maps and charts corresponding to those parts of the flight are current and have not been amended since the last cycle;
 - (4) any MEL limitations, where available, are observed; and
 - (5) the database has expired by no more than 28 days.

GM1 NCO.GEN.105 Pilot-in-command responsibilities and authority

GENERAL

In accordance with 1.c. of Annex IV to Regulation (EC) No 216/2008¹ (essential requirements for air operations), the pilot-in-command is responsible for the operation and safety of the aircraft and for the safety of all passengers and cargo on board. This includes the following:

- (a) the safety of all passengers and cargo on board, as soon as he/she arrives on board, until he/she leaves the aircraft at the end of the flight; and
- (b) the operation and safety of the aircraft:
- (1) for aeroplanes, from the moment it is first ready to move for the purpose of flight until the moment it comes to rest at the end of the flight and the engine(s) used as primary propulsion unit(s) is/are shut down;
 - (2) for helicopters, from the moment the engine(s) are started until the helicopter comes to rest at the end of the flight with the engine(s) shut down and the rotor blades stopped;
 - (3) for sailplanes, from the moment the launch procedure is started until the aircraft comes to rest at the end of the flight; or

¹ Regulation (EC) No 216/2008 of the European Parliament and of the Council of 20 February 2008 on common rules in the field of civil aviation and establishing a European Aviation Safety Agency, and repealing Council Directive 91/670/EEC, Regulation (EC) No 1592/2002 and Directive 2004/36/EC. *OJ L 79, 19.3.2008, p. 1*, as amended by Regulation (EC) No 1108/2009 of the European Parliament and of the Council of 21 October 2009, *OJ L 309, 24.11.2009, p. 51*.

- (4) for balloons, from the moment the inflating of the envelope is started until the envelope is deflated.

GM1 NCO.GEN.105(a)(8) Pilot-in-command responsibilities and authority

RECORDING UTILISATION DATA

Where an aircraft conducts a series of flights of short duration — such as a helicopter doing a series of lifts — and the aircraft is operated by the same pilot-in-command, the utilisation data for the series of flights may be recorded in the aircraft technical log or journey log as a single entry.

AMC1 NCO.GEN.105(c) Pilot-in-command responsibilities and authority

CHECKLISTS

- (a) The pilot-in-command should use the latest checklists provided by the manufacturer.
- (b) If checks conducted prior to take-off are suspended at any point, the pilot-in-command should re-start them from a safe point prior to the interruption.

GM1 NCO.GEN.105(d) Pilot-in-command responsibilities and authority

REPORTING OF HAZARDOUS FLIGHT CONDITIONS

- (a) These reports should include any detail which may be pertinent to the safety of other aircraft.
- (b) Such reports should be made whenever any of the following conditions are encountered or observed:
- (1) severe turbulence;
 - (2) severe icing;
 - (3) severe mountain wave;
 - (4) thunderstorms, with or without hail, that are obscured, embedded, widespread or in squall lines;
 - (5) heavy dust storm or heavy sandstorm;
 - (6) volcanic ash cloud; and
 - (7) unusual and/or increasing volcanic activity or a volcanic eruption.
- (c) When other meteorological conditions not listed above, e.g. wind shear, are encountered that, in the opinion of the pilot-in-command, may affect the safety or the efficiency of other aircraft operations, the pilot-in-command should advise the appropriate air traffic services (ATS) unit as soon as practicable.

AMC1 NCO.GEN.105(e) Pilot-in-command responsibilities and authority

VIOLATION REPORTING

If required by the State in which the incident occurs, the pilot-in-command should submit a report on any such violation to the appropriate authority of such State; in that event, the pilot-in-command should also submit a copy of it to the competent authority. Such reports should be submitted as soon as possible and normally within 10 days.

NCO.GEN.106 Pilot-in-command responsibilities and authority — balloons

The pilot-in-command of a balloon shall in addition to NCO.GEN.105:

- (a) be responsible for the pre-flight briefing of those persons assisting in the inflation and deflation of the envelope;
- (b) ensure that no person is smoking on board or within the direct vicinity of the balloon; and
- (c) ensure that persons assisting in the inflation and deflation of the envelope wear appropriate protective clothing.

GM1 NCO.GEN.106(b) Pilot-in-command responsibilities and authority — balloons**PROTECTIVE CLOTHING**

Protective clothing includes:

- (a) long sleeves and trousers preferably made out of natural fibres;
- (b) stout footwear; and
- (c) gloves.

NCO.GEN.110 Compliance with laws, regulations and procedure

- (a) The pilot-in-command shall comply with the laws, regulations and procedures of those States where operations are conducted.
- (b) The pilot-in-command shall be familiar with the laws, regulations and procedures, pertinent to the performance of his/her duties, prescribed for the areas to be traversed, the aerodromes or operating sites to be used and the related air navigation facilities as referred to in 1.a of Annex IV to Regulation (EC) No 216/2008.

NCO.GEN.115 Taxiing of aeroplanes

An aeroplane shall only be taxied on the movement area of an aerodrome if the person at the controls:

- (a) is an appropriately qualified pilot; or
- (b) has been designated by the operator and:
 - (1) is trained to taxi the aeroplane;
 - (2) is trained to use the radio telephone, if radio communications are required;
 - (3) has received instruction in respect of aerodrome layout, routes, signs, marking, lights, air traffic control (ATC) signals and instructions, phraseology and procedures; and
 - (4) is able to conform to the operational standards required for safe aeroplane movement at the aerodrome.

GM1 NCO.GEN.115 Taxiing of aeroplanes

SAFETY-CRITICAL ACTIVITY

- (a) Taxiing should be treated as a safety-critical activity due to the risks related to the movement of the aeroplane and the potential for a catastrophic event on the ground.
- (b) Taxiing is a high-workload phase of flight that requires the full attention of the pilot-in-command.

GM1 NCO.GEN.115(b)(4) Taxiing of aeroplanes

SKILLS AND KNOWLEDGE

The person designated by the operator to taxi an aeroplane should possess the following skills and knowledge:

- (a) positioning of the aeroplane to ensure safety when starting engine;
- (b) getting ATIS reports and taxi clearance, where applicable;
- (c) interpretation of airfield markings/lights/signals/indicators;
- (d) interpretation of marshalling signals, where applicable;
- (e) identification of suitable parking area;
- (f) maintaining lookout and right-of-way rules and complying with ATC or marshalling instructions when applicable;
- (g) avoidance of adverse effect of propeller slipstream or jet wash on other aeroplanes, aerodrome facilities and personnel;

- (h) inspection of taxi path when surface conditions are obscured;
- (i) communication with others when controlling an aeroplane on the ground;
- (j) interpretation of operational instructions;
- (k) reporting of any problem that may occur while taxiing an aeroplane; and
- (l) adapting the taxi speed in accordance with prevailing aerodrome, traffic, surface and weather conditions.

NCO.GEN.120 Rotor engagement — helicopters

A helicopter rotor shall only be turned under power for the purpose of flight with a qualified pilot at the controls.

GM1 NCO.GEN.120 Rotor engagement

INTENT OF THE RULE

- (a) The following two situations where it is allowed to turn the rotor under power should be distinguished:
- (1) for the purpose of flight, this is described in the implementing rule;
 - (2) for maintenance purposes.
- (b) Rotor engagement for the purpose of flight: it should be noted that the pilot should not leave the control when the rotors are turning. For example, the pilot is not allowed to get out of the aircraft in order to welcome passengers and adjust their seat belts with the rotors turning.
- (c) Rotor engagement for the purpose of maintenance: the implementing rule, however, should not prevent ground runs being conducted by qualified personnel other than pilots for maintenance purposes.

The following conditions should be applied:

- (1) The operator should ensure that the qualification of personnel, other than pilots, who are authorised to conduct maintenance runs is described in the appropriate manual.
- (2) Ground runs should not include taxiing the helicopter.
- (3) There should be no passengers on board.
- (4) Maintenance runs should not include collective increase or auto pilot engagement (risk of ground resonance).

NCO.GEN.125 Portable electronic devices

The pilot-in-command shall not permit any person to use a portable electronic device (PED) on board an aircraft that could adversely affect the performance of the aircraft's systems and equipment.

GM1 NCO.GEN.125 Portable electronic devices

DEFINITIONS

(a) Definition and categories of PEDs

PEDs are any kind of electronic device, typically but not limited to consumer electronics, brought on board the aircraft by crew members, passengers, or as part of the cargo and that are not included in the approved aircraft configuration. All equipment that is able to consume electrical energy falls under this definition. The electrical energy can be provided from internal sources as batteries (chargeable or non-rechargeable) or the devices may also be connected to specific aircraft power sources.

PEDs include the following two categories:

- (1) Non-intentional transmitters can non-intentionally radiate RF transmissions, sometimes referred to as spurious emissions. This category includes, but is not limited to, calculators, cameras, radio receivers, audio and video players, electronic games and toys; when these devices are not equipped with a transmitting function.
- (2) Intentional transmitters radiate RF transmissions on specific frequencies as part of their intended function. In addition, they may radiate non-intentional transmissions like any PED. The term 'transmitting PED' (T-PED) is used to identify the transmitting capability of the PED. Intentional transmitters are transmitting devices such as RF-based remote control equipment, which may include some toys, two-way radios (sometimes referred to as private mobile radio), mobile phones of any type, satellite phones, computers with mobile phone data connection, wireless local area network (WLAN) or Bluetooth capability. After deactivation of the transmitting capability, e.g. by activating the so-called 'flight mode' or 'flight safety mode', the T-PED remains a PED having non-intentional emissions.

(b) Definition of the switched-off status

Many PEDs are not completely disconnected from the internal power source when switched off. The switching function may leave some remaining functionality e.g. data storage, timer, clock, etc. These devices can be considered switched off when in the deactivated status. The same applies for devices having no transmitting capability and are operated by coin cells without further deactivation capability, e.g. wrist watches.

GM2 NCO.GEN.125 Portable electronic devices

GENERAL

- (a) PEDs can pose a risk of interference with electronically operated aircraft systems. Those systems could range from the electronic engine control, instruments, navigation or communication equipment, autopilots to any other type of avionic equipment on the aircraft. The interference can result in on-board systems malfunctioning or providing misleading information and communication disturbance. These can also lead to an increased workload for the flight crew.
- (b) Interference may be caused by transmitters being part of the PED's functionality or by unintentional transmissions from the PED. Due to the likely proximity of the PED to any

electronically operated aircraft system and the generally limited shielding found in small aircraft, the risk of interference is to be considered higher than that for larger aircraft with metal airframes.

- (c) During certification of the aircraft, when qualifying the aircraft functions consideration may only have been made of short-term exposure to a high radiating field, with an acceptable mitigating measure being a return to normal function after removal of the threat. This certification assumption may not be true when operating the transmitting PED on board the aircraft.
- (d) It has been found that compliance with the electromagnetic compatibility (EMC) Directive 2004/108/EC and related European standards, as indicated by the CE marking, is not sufficient to exclude the existence of interference. A well-known interference is the demodulation of the transmitted signal from GSM (global system for mobile communications) mobile phones leading to audio disturbances in other systems. Similar interferences are difficult to predict during the PED design and protecting the aircraft's electronic systems against the full range of potential interferences is practically impossible. Therefore, not operating PEDs on-board aircraft is the safest option, especially as effects may not be identified immediately but under the most inconvenient circumstances.
- (e) Guidance to follow in case of fire caused by PEDs is provided by the International Civil Aviation Organisation, 'Emergency response guidance for aircraft incidents involving dangerous goods', ICAO Doc 9481-AN/928.

NCO.GEN.130 Information on emergency and survival equipment carried

Except for aircraft taking-off and landing at the same aerodrome/operating site, the operator shall, at all times, have available for immediate communication to rescue coordination centres (RCCs) lists containing information on the emergency and survival equipment carried on board.

AMC1 NCO.GEN.130 Information on emergency and survival equipment carried

CONTENT OF INFORMATION

The information, compiled in a list, should include, as applicable:

- (a) the number, colour and type of life rafts and pyrotechnics,
- (b) details of emergency medical supplies and water supplies; and
- (c) the type and frequencies of the emergency portable radio equipment.

NCO.GEN.135 Documents, manuals and information to be carried

- (a) The following documents, manuals and information shall be carried on each flight as originals or copies unless otherwise specified:
- (1) the AFM, or equivalent document(s);
 - (2) the original certificate of registration;
 - (3) the original certificate of airworthiness (CofA);
 - (4) the noise certificate, if applicable;
 - (5) the list of specific approvals, if applicable;
 - (6) the aircraft radio licence, if applicable;
 - (7) the third party liability insurance certificate(s);
 - (8) the journey log, or equivalent, for the aircraft;
 - (9) details of the filed ATS flight plan, if applicable;
 - (10) current and suitable aeronautical charts for the route area of the proposed flight and all routes along which it is reasonable to expect that the flight may be diverted;
 - (11) procedures and visual signals information for use by intercepting and intercepted aircraft;
 - (12) the MEL or CDL, if applicable; and
 - (13) any other documentation that may be pertinent to the flight or is required by the States concerned with the flight.
- (b) Notwithstanding (a), on flights:
- (1) intending to take off and land at the same aerodrome/operating site; or
 - (2) remaining within a distance or area determined by the competent authority,
- the documents and information in (a)(2) to (a)(8) may be retained at the aerodrome or operating site.
- (c) Notwithstanding (a), on flights with balloons or sailplanes, excluding touring motor gliders (TMGs), the documents and information in (a)(2) to (a)(8) and (a)(11) to (a)(13) may be carried in the retrieve vehicle.
- (d) The pilot-in-command shall make available within a reasonable time of being requested to do so by the competent authority, the documentation required to be carried on board.

AMC1 NCO.GEN.135(a)(3) Documents, manuals and information to be carried**CERTIFICATE OF AIRWORTHINESS**

The certificate of airworthiness should be a normal certificate of airworthiness, a restricted certificate of airworthiness or a permit to fly issued in accordance with the applicable airworthiness requirements.

AMC1 NCO.GEN.135(a)(10) Documents, manuals and information to be carried

CURRENT AND SUITABLE AERONAUTICAL CHARTS

- (a) The aeronautical charts carried should contain data appropriate to the applicable air traffic regulations, rules of the air, flight altitudes, area/route and nature of the operation. Due consideration should be given to carriage of textual and graphic representations of:
- (1) aeronautical data, including, as appropriate for the nature of the operation:
 - (i) airspace structure;
 - (ii) significant points, navigation aids (navaids) and air traffic services (ATS) routes;
 - (iii) navigation and communication frequencies;
 - (iv) prohibited, restricted and danger areas; and
 - (v) sites of other relevant activities that may hazard the flight; and
 - (2) topographical data, including terrain and obstacle data.
- (b) A combination of different charts and textual data may be used to provide adequate and current data.
- (c) The aeronautical data should be appropriate for the current aeronautical information regulation and control (AIRAC) cycle.
- (d) The topographical data should be reasonably recent, having regard to the nature of the planned operation.

GM1 NCO.GEN.135 Documents, manuals and information to be carried

GENERAL

- (a) In case of loss or theft of documents specified in NCO.GEN.135, the operation may continue until the flight reaches the base or a place where a replacement document can be provided.
- (b) The documents, manuals and information may be available in a form other than on printed paper. An electronic storage medium is acceptable if accessibility, usability and reliability can be assured.

GM1 NCO.GEN.135(a)(1) Documents, manuals and information to be carried

AFM OR EQUIVALENT DOCUMENT

‘Aircraft flight manual (AFM), or equivalent document’ means the flight manual for the aircraft or other documents containing information required for the operation of the aircraft within the terms of its certificate of airworthiness.

AIRCRAFT FLIGHT MANUAL (AFM) — BALLOONS

At least the operating limitations, normal and emergency procedures should be available to the pilot during operation by providing the specific sections of the AFM or by other means (e.g. placards, quick reference cards) that effectively accomplish the purpose.

GM1 NCO.GEN.135(a)(8) Documents, manuals and information to be carried

JOURNEY LOG OR EQUIVALENT

'Journey log or equivalent' means that the required information may be recorded in documentation other than a log book, such as the operational flight plan or the aircraft technical log.

GM1 NCO.GEN.135(a)(11) Documents, manuals and information to be carried

PROCEDURES AND VISUAL SIGNALS FOR USE BY INTERCEPTING AND INTERCEPTED AIRCRAFT

The procedures and the visual signals information for use by intercepting and intercepted aircraft are those contained in the International Civil Aviation Organisation's (ICAO) Annex 2.

GM1 NCO.GEN.135(a)(13) Documents, manuals and information to be carried

DOCUMENTS THAT MAY BE PERTINENT TO THE FLIGHT

Any other documents that may be pertinent to the flight or required by the States concerned with the flight may include, for example, forms to comply with reporting requirements.

STATES CONCERNED WITH THE FLIGHT

The States concerned are those of origin, transit, overflight and destination of the flight.

NCO.GEN.140 Transport of dangerous goods

- (a) The transport of dangerous goods by air shall be conducted in accordance with Annex 18 to the Chicago Convention as last amended and amplified by the Technical Instructions for the Safe Transport of Dangerous Goods by Air (ICAO Doc 9284-AN/905), including its supplements and any other addenda or corrigenda.
- (b) Dangerous goods shall only be transported by the operator approved in accordance with Annex V (Part-SPA), Subpart G, to Regulation (EU) No 965/2012 except when:
 - (1) they are not subject to the Technical Instructions in accordance with Part 1 of those Instructions; or
 - (2) they are carried by passengers or the pilot-in-command, or are in baggage, in accordance with Part 8 of the Technical Instructions;
 - (3) they are carried by operators of ELA2 aircraft.
- (c) The pilot-in-command shall take all reasonable measures to prevent dangerous goods from being carried on board inadvertently.
- (d) The pilot-in-command shall, in accordance with the Technical Instructions, report without delay to the competent authority and the appropriate authority of the State of occurrence in the event of any dangerous goods accidents or incidents.
- (e) The pilot-in-command shall ensure that passengers are provided with information about dangerous goods in accordance with the Technical Instructions.
- (f) Reasonable quantities of articles and substances that would otherwise be classified as dangerous goods and that are used to facilitate flight safety, where carriage aboard the aircraft is advisable to ensure their timely availability for operational purposes, shall be considered authorised under paragraph 1;2.2.1(a) of the Technical Instructions. This is regardless of whether or not such articles and substances are required to be carried or intended to be used in connection with a particular flight.

The packing and loading on board of the above-mentioned articles and substances shall be performed, under the responsibility of the pilot in command, in such a way as to minimise the risks posed to crew members, passengers, cargo or the aircraft during aircraft operations.

GM1 NCO.GEN.140(a) Transport of dangerous goods**GENERAL**

- (a) The requirement to transport dangerous goods by air in accordance with the Technical Instructions is irrespective of whether:
 - (1) the flight is wholly or partly within or wholly outside the territory of a State; or
 - (2) an approval to carry dangerous goods in accordance with Annex V (Part-SPA), Subpart G is held.
- (b) The Technical Instructions provide that in certain circumstances dangerous goods, which are normally forbidden on an aircraft, may be carried. These circumstances include cases of extreme urgency or when other forms of transport are inappropriate or when full compliance with the prescribed requirements is contrary to the public interest. In these circumstances all the States concerned may grant exemptions from the provisions of the Technical Instructions provided that an overall level of safety that is at least equivalent to that provided by the Technical Instructions is achieved. Although exemptions are most likely to be granted for the carriage of dangerous

goods that are not permitted in normal circumstances, they may also be granted in other circumstances, such as when the packaging to be used is not provided for by the appropriate packing method or the quantity in the packaging is greater than that permitted. The Technical Instructions also make provision for some dangerous goods to be carried when an approval has been granted only by the State of origin and the competent authority.

- (c) When an exemption is required, the States concerned are those of origin, transit, overflight and destination of the consignment and that of the operator. For the State of overflight, if none of the criteria for granting an exemption are relevant, an exemption may be granted based solely on whether it is believed that an equivalent level of safety in air transport has been achieved.
- (d) The Technical Instructions provide that exemptions and approvals are granted by the 'appropriate national authority', which is intended to be the authority responsible for the particular aspect against which the exemption or approval is being sought. The operator should ensure that all relevant conditions on an exemption or approval are met.
- (e) The exemption or approval referred to in (b) to (d) is in addition to the approval required by Annex V (Part-SPA), Subpart G.

AMC1 NCO.GEN.140(d) Transport of dangerous goods

DANGEROUS GOODS ACCIDENT AND INCIDENT REPORTING

- (a) Any type of dangerous goods incident or accident, or the finding of:
 - (1) undeclared or misdeclared dangerous goods in cargo;
 - (2) forbidden dangerous goods in mail; or
 - (3) forbidden dangerous goods in passenger or crew baggage, or on the person of a passenger or crew membershould be reported. For this purpose, the Technical Instructions consider that reporting of undeclared and misdeclared dangerous goods found in cargo also applies to items of operators' stores that are classified as dangerous goods.
- (b) The first report should be dispatched within 72 hours of the event. It may be sent by any means, including e-mail, telephone or fax. This report should include the details that are known at that time, under the headings identified in 3. If necessary, a subsequent report should be made as soon as possible giving all the details that were not known at the time the first report was sent. If a report has been made verbally, written confirmation should be sent as soon as possible.
- (c) The first and any subsequent report should be as precise as possible and contain the following data, where relevant:
 - (1) date of the incident or accident or the finding of undeclared or misdeclared dangerous goods;
 - (2) location and date of flight;
 - (3) description of the goods;
 - (4) proper shipping name (including the technical name, if appropriate) and United Nations (UN)/identification (ID) number, when known;
 - (5) class or division and any subsidiary risk;
 - (6) type of packaging, and the packaging specification marking on it;
 - (7) quantity;

- (8) name and address of the passenger, etc.;
- (9) any other relevant details;
- (10) suspected cause of the incident or accident;
- (11) action taken;
- (12) any other reporting action taken; and
- (13) name, title, address and telephone number of the person making the report.
- (d) Copies of relevant documents and any photographs taken should be attached to the report.
- (e) A dangerous goods accident or incident may also constitute an aircraft accident, serious incident or incident. The criteria for reporting both types of occurrence should be met.
- (f) The following dangerous goods reporting form should be used, but other forms, including electronic transfer of data, may be used provided that at least the minimum information of this AMC is supplied:

DANGEROUS GOODS OCCURRENCE REPORT		DGOR No:	
1. Operator:	2. Date of Occurrence:	3. Local time of occurrence:	
4. Flight date:			
5. Departure aerodrome:		6. Destination aerodrome:	
7. Aircraft type:		8. Aircraft registration:	
9. Location of occurrence:		10. Origin of the goods:	
11. Description of the occurrence, including details of injury, damage, etc. (if necessary continue on the reverse of this form):			
12. Proper shipping name (including the technical name):			13. UN/ID No (when known):
14. Class/Division (when known):	15. Subsidiary risk(s):	16. Packing group:	17. Category (Class 7 only):
18. Type of packaging:	19. Packaging specification marking:	20. No of packages:	21. Quantity (or transport index, if applicable):
22. Name and address of passenger, etc.:			
23. Other relevant information (including suspected cause, any action taken):			
24. Name and title of person making report:		25. Telephone No:	

26. Company:	27. Reporters ref:
28. Address:	29. Signature:
	30. Date:
Description of the occurrence (continuation)	

Notes for completion of the form:

1. A dangerous goods accident is as defined in Annex I. For this purpose serious injury is as defined in Regulation (EU) No 996/2010 of the European Parliament and of the Council².
2. The initial report should be dispatched unless exceptional circumstances prevent this. This occurrence report form, duly completed, should be sent as soon as possible, even if all the information is not available.
3. Copies of all relevant documents and any photographs should be attached to this report.
4. Any further information, or any information not included in the initial report, should be sent as soon as possible to the authorities identified in NCO.GEN.140(d).
5. Providing it is safe to do so, all dangerous goods, packaging, documents, etc. relating to the occurrence should be retained until after the initial report has been sent to the authorities identified in NCO.GEN.140(d), and they have indicated whether or not these should continue to be retained.

AMC1 NCO.GEN.140(f) Transport of dangerous goods

GENERAL

The quantities of DG carried for operational purposes should be reasonable considering the purposes for which they might be required before the aircraft is able to replenish its supplies, e.g. at its home base or, in the case of a long tour, at any aerodrome along the route where the aircraft is planned to land and where such supplies are available.

GM1 NCO.GEN.140(f) Transport of dangerous goods

GENERAL

In addition to items authorised under paragraph 1;2.2.1(a) of the Technical Instructions, the articles and substances should be items such as, e.g. aircraft spare parts, components/substances needed for aircraft repair, oil (for aircraft engine/gearbox), aircraft fuel, de-icing fluid, aircraft battery, and air starter unit.

² OJ L 295, 12.11.2010, p. 35.

NCO.GEN.145 Immediate reaction to a safety problem

The operator shall implement:

- (a) any safety measures mandated by the competent authority in accordance with ARO.GEN.135(c); and
- (b) any relevant mandatory safety information issued by the Agency, including airworthiness directives.

NCO.GEN.150 Journey log

Particulars of the aircraft, its crew and each journey shall be retained for each flight, or series of flights, in the form of a journey log, or equivalent.

AMC1 NCO.GEN.150 Journey log**GENERAL**

- (a) The aircraft journey log, or equivalent, should include the following items, where applicable:
 - (1) aircraft nationality and registration;
 - (2) date;
 - (3) name of crew member(s);
 - (4) duty assignments of crew members, if applicable;
 - (5) place of departure;
 - (6) place of arrival;
 - (7) time of departure;
 - (8) time of arrival;
 - (9) hours of flight;
 - (10) nature of flight;
 - (11) incidents and observations (if any); and
 - (12) signature of the pilot-in-command.
- (b) The information or parts thereof may be recorded in a form other than on printed paper. Accessibility, usability and reliability should be assured.

NCO.GEN.155 Minimum equipment list

- (a) An MEL may be established taking into account the following:
- (1) the document shall provide for the operation of the aircraft, under specified conditions, with particular instruments, items of equipment or functions inoperative at the commencement of the flight;
 - (2) the document shall be prepared for each individual aircraft, taking account of the operator's relevant operational and maintenance conditions; and
 - (3) the MEL shall be based on the relevant Master Minimum Equipment List (MMEL), as defined in the data established in accordance with Commission Regulation (EU) No 748/2012³, and shall not be less restrictive than the MMEL.
- (b) The MEL and any amendment thereto shall be notified to the competent authority.

AMC1 NCO.GEN.155 Minimum equipment list

CONTENT AND APPROVAL OF THE MEL

- (a) When an MEL is established, the operator should amend the MEL after any applicable change to the MMEL within the acceptable timescales. The following are applicable changes to the MMEL that require amendment of the MEL:
- (1) a reduction of the rectification interval;
 - (2) change of an item, only when the change is applicable to the aircraft or type of operations and is more restrictive;
 - (3) reduced timescales for the implementation of safety-related amendments may be required by the Agency and/or the competent authority.
- (b) An acceptable timescale for notifying the amended MEL to the competent authority is 90 days from the effective date specified in the approved change to the MMEL.
- (c) In addition to the list of items and related dispatch conditions, the MEL should contain:
- (1) a preamble, including guidance and definitions for flight crew members and maintenance personnel using the MEL. The MEL preamble should:
 - (i) reflect the content of the MMEL preamble as applicable to the MEL scope and extent;
 - (ii) contain terms and definitions used in the MEL;
 - (iii) contain any other relevant specific information for the MEL scope and use that is not originally provided in the MMEL;
 - (iv) provide guidance on how to identify the origin of a failure or malfunction to the extent necessary for appropriate application of the MEL;
 - (v) provide guidance on the management of multiple unserviceabilities, based on the guidance given in the MMEL; and
 - (vi) provide guidance on placarding of inoperative items to inform crew members of equipment condition as appropriate. In particular, when such items are accessible to the crew during flight, the control(s) and indicator(s) related to inoperative unit(s) should be clearly placarded.

³ OJ L 224, 21.8.2012, p. 1.

- (2) the revision status of the MMEL upon which the MEL is based and the revision status of the MEL;
 - (3) the scope, extent and purpose of the MEL;
 - (4) operational and maintenance procedures as part of the MEL or by means of reference to another appropriate document, based on the operational and maintenance procedures referenced in the MMEL; and
 - (5) the dispatch conditions associated with flights conducted in accordance with special approvals held by the operator in accordance with Part-SPA.
- (d) The operator should:
- (1) establish rectification intervals for each inoperative instrument, item of equipment or function listed in the MEL. The rectification interval in the MEL should not be less restrictive than the corresponding rectification interval in the MMEL. The definitions and categories of rectification intervals are provided in CS-MMEL as well as in CS-GEN-MMEL; and
 - (2) establish an effective rectification programme.
- (e) The operator should establish the operational and maintenance procedures referenced in the MEL, taking into account the operational and maintenance procedures referenced in the MMEL. These procedures should be part of the operator's manuals or the MEL.
- (f) The operator should amend the operational and maintenance procedures referenced in the MEL after any applicable change to the operational and maintenance procedures referenced in the MMEL.
- (g) Unless otherwise specified in the MEL, the operator should complete:
- (1) the operational procedures referenced in the MEL when planning for and/or operating with the listed item inoperative; and
 - (2) the maintenance procedures referenced in the MEL prior to operating with the listed item inoperative.

AMC2 NCO.GEN.155 Minimum equipment list

FORMAT OF THE MEL

The MEL format, the presentation of MEL items and dispatch conditions should:

- (a) reflect those of the MMEL;
- (b) follow the ATA 100/2200 Specification numbering system for MEL items; and
- (c) when different from (a) and (b), be clear and unambiguous.

AMC3 NCO.GEN.155 Minimum equipment list

EXTENT OF THE MEL

The operator should include guidance in the MEL on how to deal with any failures that occur between the commencement of the flight and the start of the take-off. If a failure occurs between the commencement of the flight and the start of the take-off, any decision to continue the flight should be subject to pilot judgement and good airmanship. The pilot-in-command may refer to the MEL before any decision to continue the flight is taken.

AMC4 NCO.GEN.155 Minimum equipment list

OPERATIONAL AND MAINTENANCE PROCEDURES

- (a) The operational and maintenance procedures referenced in the MEL should be based on the operational and maintenance procedures referenced in the MMEL. Modified procedures may, however, be developed by the operator when they provide the same level of safety as required by the MMEL. Modified maintenance procedures should be developed in accordance with the applicable airworthiness requirements.
- (b) Providing appropriate operational and maintenance procedures referenced in the MEL, regardless of who developed them, is the responsibility of the operator.
- (c) Any item in the MEL requiring an operational or maintenance procedure to ensure an acceptable level of safety should be so identified in the ‘remarks’ or ‘exceptions’ column/part/section of the MEL. This will normally be ‘(O)’ for an operational procedure, or ‘(M)’ for a maintenance procedure. ‘(O)(M)’ means both operational and maintenance procedures are required.
- (d) The satisfactory accomplishment of all procedures, regardless of who performs them, is the responsibility of the operator.

AMC5 NCO.GEN.155 Minimum equipment list

OPERATIONAL AND MAINTENANCE PROCEDURES — APPLICABLE CHANGES

- (a) Changes to the operational and maintenance procedures referenced in the MMEL are considered applicable and require the amendment of the maintenance and operating procedures referenced in the MEL when:
 - (1) the modified procedure is applicable to the operator’s MEL; and
 - (2) the purpose of this change is to improve compliance with the intent of the associated MMEL dispatch condition.
- (b) An acceptable timescale for the amendments of maintenance and operating procedures, as defined in (a), should be 90 days from the date when the amended procedures referenced in the MMEL are made available. Reduced timescales for the implementation of safety-related amendments may be required if the competent authority consider it necessary.

GM1 NCO.GEN.155 Minimum equipment list

GENERAL

- (a) The Minimum Equipment List (MEL) is a document that lists the equipment that may be temporarily inoperative, subject to certain conditions, at the commencement of flight. This document is prepared by the operator for their own particular aircraft, taking account of their aircraft configuration and all those individual variables that cannot be addressed at MMEL level, such as operating environment, route structure, geographic location, aerodromes where spare parts and maintenance capabilities are available, etc.
- (b) The MMEL, as defined in the mandatory part of the operational suitability data established in accordance with Regulation (EU) No 748/2012, is developed in compliance with CS-MMEL or CS-GEN-MMEL. These Certification Specifications contain, among other, guidance intended to standardise the level of relief granted in MMELs, in particular for items that are subject to operational requirements. If an MMEL established as part of the operational suitability data is not available and items subject to operational requirements are listed in the available MMEL

without specific relief or dispatch conditions but only with a reference to the operational requirements, the operator may refer to CS-MMEL or CS-GEN-MMEL guidance material, as applicable, to develop the relevant MEL content for such items.

GM2 NCO.GEN.155 Minimum equipment list

SCOPE OF THE MEL

- (a) Examples of special approvals in accordance with Part-SPA may be:
 - (1) RVSM
 - (2) LVO
- (b) When an aircraft has installed equipment which is not required for the operations conducted, the operator may wish to delay rectification of such items for an indefinite period. Such cases are considered to be out of the scope of the MEL, therefore modification of the aircraft is appropriate and deactivation, inhibition or removal of the item should be accomplished by an appropriate approved modification procedure.

GM3 NCO.GEN.155 Minimum equipment list

PURPOSE OF THE MEL

The MEL is an alleviating document having the purpose to identify the minimum equipment and conditions to operate safely an aircraft having inoperative equipment. Its purpose is not, however, to encourage the operation of aircraft with inoperative equipment. It is undesirable for aircraft to be dispatched with inoperative equipment and such operations are permitted only as a result of careful analysis of each item to ensure that the acceptable level of safety, as intended in the applicable airworthiness and operational requirements, is maintained. The continued operation of an aircraft in this condition should be minimised.

GM4 NCO.GEN.155 Minimum equipment list

OPERATIONAL AND MAINTENANCE PROCEDURES

- (a) Operational and maintenance procedures are an integral part of the compensating conditions needed to maintain an acceptable level of safety, enabling the competent authority to approve the MEL.
- (b) Normally, operational procedures are accomplished by the flight crew; however, other personnel may be qualified and authorised to perform certain functions.
- (c) Normally, maintenance procedures are accomplished by the maintenance personnel; however, other personnel may be qualified and authorised to perform certain functions in accordance with the applicable airworthiness requirements.
- (d) Operational and maintenance procedures, regardless of the document where they are contained, should be readily available for use when needed for the application of the MEL.
- (e) Unless specifically permitted by a maintenance procedure, an inoperative item may not be removed from the aircraft.

SUBPART B: OPERATIONAL PROCEDURES

NCO.OP.100 Use of aerodromes and operating sites

The pilot-in-command shall only use aerodromes and operating sites that are adequate for the type of aircraft and operation concerned.

GM1 NCO.OP.100 Use of aerodromes and operating sites

BALLOONS

An adequate site is a site that the pilot-in-command considers to be satisfactory, taking account of the applicable performance requirements and site characteristics.

NCO.OP.105 Specification of isolated aerodromes — aeroplanes

For the selection of alternate aerodromes and the fuel policy, the pilot-in-command shall consider an aerodrome as an isolated aerodrome if the flying time to the nearest adequate destination alternate aerodrome is more than:

- (a) for aeroplanes with reciprocating engines, 60 minutes; or
- (b) for aeroplanes with turbine engines, 90 minutes.

NCO.OP.110 Aerodrome operating minima — aeroplanes and helicopters

- (a) For instrument flight rules (IFR) flights, the pilot-in-command shall select and use aerodrome operating minima for each departure, destination and alternate aerodrome. Such minima shall:
 - (1) not be lower than those established by the State in which the aerodrome is located, except when specifically approved by that State; and
 - (2) when undertaking low visibility operations, be approved by the competent authority in accordance with Annex V (Part-SPA), Subpart E to Regulation (EU) No 965/2012.
- (b) When selecting the aerodrome operating minima, the pilot-in-command shall take the following into account:
 - (1) the type, performance and handling characteristics of the aircraft;
 - (2) his/her competence and experience;
 - (3) the dimensions and characteristics of the runways and final approach and take-off areas (FATOs) that may be selected for use;
 - (4) the adequacy and performance of the available visual and non-visual ground aids;
 - (5) the equipment available on the aircraft for the purpose of navigation and/or control of the flight path, during the take-off, the approach, the flare, the landing, the rollout and the missed approach;
 - (6) the obstacles in the approach, the missed approach and the climb-out areas necessary for the execution of contingency procedures;
 - (7) the obstacle clearance altitude/height for the instrument approach procedures;
 - (8) the means to determine and report meteorological conditions; and
 - (9) the flight technique to be used during the final approach.
- (c) The minima for a specific type of approach and landing procedure shall only be used if:
 - (1) the ground equipment required for the intended procedure is operative;
 - (2) the aircraft systems required for the type of approach are operative;
 - (3) the required aircraft performance criteria are met; and
 - (4) the pilot is qualified appropriately.

AMC1 NCO.OP.110 Aerodrome operating minima — aeroplanes and helicopters

TAKE-OFF OPERATIONS

(a) General:

- (1) Take-off minima should be expressed as visibility (VIS) or runway visual range (RVR) limits, taking into account all relevant factors for each aerodrome planned to be used and aircraft characteristics. Where there is a specific need to see and avoid obstacles on departure and/or for a forced landing, additional conditions, e.g. ceiling, it should be specified.
- (2) When the reported meteorological visibility is below that required for take-off and RVR is not reported, a take-off should only be commenced if the pilot-in-command can determine that the visibility along the take-off runway/area is equal to or better than the required minimum.
- (3) When no reported meteorological visibility or RVR is available, a take-off should only be commenced if the pilot-in-command can determine that the RVR/VIS along the take-off runway/area is equal to or better than the required minimum.

(b) Visual reference:

- (1) The take-off minima should be selected to ensure sufficient guidance to control the aircraft in the event of both a rejected take-off in adverse circumstances and a continued take-off after failure of the critical engine.
- (2) For night operations, ground lights should be available to illuminate the runway/final approach and take-off area (FATO) and any obstacles.

AMC2 NCO.OP.110 Aerodrome operating minima — aeroplanes and helicopters

VISUAL APPROACH

For a visual approach operation, the RVR should not be less than 800 m.

AMC3 NCO.OP.110 Aerodrome operating minima — aeroplanes and helicopters

EFFECT ON LANDING MINIMA OF TEMPORARILY FAILED OR DOWNGRADED GROUND EQUIPMENT

- (a) Non-precision approaches requiring a final approach fix (FAF) and/or missed approach point (MAPt) should not be conducted where a method of identifying the appropriate fix is not available.
- (b) A minimum RVR of 750 m should be used for CAT I approaches in the absence of centreline lines and/or touchdown zone lights.
- (c) Where approach lighting is partly unavailable, minima should take account of the serviceable length of approach lighting.

GM1 NCO.OP.110 Aerodrome operating minima — aeroplanes and helicopters

COMMERCIALY AVAILABLE INFORMATION

An acceptable method of selecting aerodrome operating minima is through the use of commercially available information.

GM2 NCO.OP.110 Aerodrome operating minima — aeroplanes and helicopters

VERTICAL PATH CONTROL

Due consideration should be given to the selection of an appropriate technique for vertical path control on non-precision approaches (NPAs). Where appropriate instrumentation and/or facilities are available, a continuous descent final approach technique (CDFA) usually offers increased safety and a lower workload compared to a step-down approach.

GM3 NCO.OP.110 Aerodrome operating minima — aeroplanes and helicopters

CRITERIA FOR ESTABLISHING RVR/CMV

- (a) In order to qualify for the lowest allowable values of RVR/CMV specified in Table 3.A, the instrument approach should meet at least the following facility requirements and associated conditions:
- (1) Instrument approaches with designated vertical profile up to and including 4.5° for Category A and B aeroplanes, or 3.77° for Category C and D aeroplanes, where the facilities are:
 - (i) instrument landing system (ILS)/microwave landing system (MLS)/GBAS landing system (GLS)/precision approach radar (PAR); or
 - (ii) approach procedure with vertical guidance (APV); andwhere the final approach track is offset by not more than 15° for Category A and B aeroplanes or by not more than 5° for Category C and D aeroplanes.
 - (2) Instrument approach operations flown using the CDFA technique with a nominal vertical profile, up to and including 4.5° for Category A and B aeroplanes, or 3.77° for Category C and D aeroplanes, where the facilities are non-directional beacon (NDB), NDB/distance measuring equipment (DME), VHF omnidirectional radio range (VOR), VOR/DME, localiser (LOC), LOC/DME, VHF direction finder (VDF), surveillance radar approach (SRA) or global navigation satellite system (GNSS)/lateral navigation (LNAV), with a final approach segment of at least 3 NM, which also fulfil the following criteria:
 - (i) the final approach track is offset by not more than 15° for Category A and B aeroplanes or by not more than 5° for Category C and D aeroplanes;
 - (ii) the final approach fix (FAF) or another appropriate fix where descent is initiated is available, or distance to threshold (THR) is available by flight management system (FMS)/area navigation (NDB/DME) or DME; and
 - (iii) the missed approach point (MAPt) is determined by timing, the distance from FAF to THR is ≤ 8 NM.
 - (3) Instrument approaches where the facilities are NDB, NDB/DME, VOR, VOR/DME, LOC, LOC/DME, VDF, SRA or GNSS/LNAV, not fulfilling the criteria in (a)(2), or with an minimum descent height (MDH) $\geq 1\,200$ ft.
- (b) The missed approach operation, after an approach operation has been flown using the CDFA technique, should be executed when reaching the decision height/altitude (DH/A) or the MAPt, whichever occurs first. The lateral part of the missed approach procedure should be flown via the MAPt unless otherwise stated on the approach chart.

GM4 NCO.OP.110 Aerodrome operating minima — aeroplanes and helicopters

DETERMINATION OF RVR/CMV/VIS MINIMA FOR NPA, APV, CAT I — AEROPLANES

- (a) The minimum RVR/CMV/VIS should be the highest of the values specified in Table 2 and Table 3.A but not greater than the maximum values specified in Table 3.A, where applicable.
- (b) The values in Table 2 should be derived from the formula below:

$$\text{required RVR/VIS (m)} = [(DH/MDH \text{ (ft)} \times 0.3048) / \tan\alpha] - \text{length of approach lights (m)}$$
 where α is the calculation angle, being a default value of 3.00° increasing in steps of 0.10° for each line in Table 2 up to 3.77° and then remaining constant.
- (c) If the approach is flown with a level flight segment at or above MDA/H, 200 m should be added for Category A and B aeroplanes and 400 m for Category C and D aeroplanes to the minimum RVR/CMV/VIS value resulting from the application of Table 2 and Table 3.A.
- (d) An RVR of less than 750 m, as indicated in Table 2, may be used:
- (1) for CAT I operations to runways with full approach lighting system (FALS), runway touchdown zone lights (RTZL) and runway centreline lights (RCLL);
 - (2) for CAT I operations to runways without RTZL and RCLL when using an approved head-up guidance landing system (HUDLS), or equivalent approved system, or when conducting a coupled approach or flight-director-flown approach to a DH. The instrument landing system (ILS) should not be published as a restricted facility; and
 - (3) for approach procedure with vertical guidance (APV) operations to runways with FALS, RTZL and RCLL when using an approved head-up display (HUD).
- (e) Lower values than those specified in Table 2 may be used for HUDLS and auto-land operations if approved in accordance with SPA.LVO.
- (f) The visual aids should comprise standard runway day markings and approach and runway lights as specified in Table 1. The competent authority may approve that RVR values relevant to a basic approach lighting system (BALS) are used on runways where the approach lights are restricted in length below 210 m due to terrain or water, but where at least one cross-bar is available.
- (g) For night operations or for any operation where credit for runway and approach lights is required, the lights should be on and serviceable, except as provided for in Table 1.
- (h) For single-pilot operations, the minimum RVR/VIS should be calculated in accordance with the following additional criteria:
- (1) an RVR of less than 800 m, as indicated in Table 2, may be used for CAT I approaches provided any of the following is used at least down to the applicable DH:
 - (i) a suitable autopilot, coupled to an ILS, microwave landing system (MLS) or GBAS landing system (GLS) that is not published as restricted; or
 - (ii) an approved HUDLS, including, where appropriate, enhanced vision system (EVS), or equivalent approved system;
 - (2) where RTZL and/or RCLL are not available, the minimum RVR/CMV should not be less than 600 m; and
 - (3) an RVR of less than 800 m, as indicated in Table 2, may be used for APV operations to runways with FALS, RTZL and RCLL when using an approved HUDLS, or equivalent approved system, or when conducting a coupled approach to a DH equal to or greater than 250 ft.

Table 1: Approach lighting systems

Class of lighting facility	Length, configuration and intensity of approach lights
FALS	CAT I lighting system (HIALS \geq 720 m) distance coded centreline, Barrette centreline
IALS	Simple approach lighting system (HIALS 420 – 719 m) single source, Barrette
BALS	Any other approach lighting system (HIALS, MIALS or ALS 210 – 419 m)
NALS	Any other approach lighting system (HIALS, MIALS or ALS $<$ 210 m) or no approach lights

Note: HIALS: high intensity approach lighting system;

MIALS: medium intensity approach lighting system;

ALS: approach lighting system.

Table 2: RVR/CMV vs. DH/MDH

DH or MDH			Class of lighting facility			
			FALS	IALS	BALS	NALS
			See (d), (e), (h). above for RVR $<$ 750/800 m			
ft			RVR/CMV (m)			
200	-	210	550	750	1 000	1 200
211	-	220	550	800	1 000	1 200
221	-	230	550	800	1 000	1 200
231	-	240	550	800	1 000	1 200
241	-	250	550	800	1 000	1 300
251	-	260	600	800	1 100	1 300
261	-	280	600	900	1 100	1 300
281	-	300	650	900	1 200	1 400
301	-	320	700	1 000	1 200	1 400
321	-	340	800	1 100	1 300	1 500
341	-	360	900	1 200	1 400	1 600

DH or MDH			Class of lighting facility			
			FALS	IALS	BALS	NALS
			See (d), (e), (h). above for RVR < 750/800 m			
ft			RVR/CMV (m)			
361	-	380	1 000	1 300	1 500	1 700
381	-	400	1 100	1 400	1 600	1 800
401	-	420	1 200	1 500	1 700	1 900
421	-	440	1 300	1 600	1 800	2 000
441	-	460	1 400	1 700	1 900	2 100
461	-	480	1 500	1 800	2 000	2 200
481		500	1 500	1 800	2 100	2 300
501	-	520	1 600	1 900	2 100	2 400
521	-	540	1 700	2 000	2 200	2 400
541	-	560	1 800	2 100	2 300	2 500
561	-	580	1 900	2 200	2 400	2 600
581	-	600	2 000	2 300	2 500	2 700
601	-	620	2 100	2 400	2 600	2 800
621	-	640	2 200	2 500	2 700	2 900
641	-	660	2 300	2 600	2 800	3 000
661	-	680	2 400	2 700	2 900	3 100
681	-	700	2 500	2 800	3 000	3 200
701	-	720	2 600	2 900	3 100	3 300
721	-	740	2 700	3 000	3 200	3 400
741	-	760	2 700	3 000	3 300	3 500
761	-	800	2 900	3 200	3 400	3 600
801	-	850	3 100	3 400	3 600	3 800

DH or MDH			Class of lighting facility			
			FALS	IALS	BALS	NALS
			See (d), (e), (h). above for RVR < 750/800 m			
ft			RVR/CMV (m)			
851	-	900	3 300	3 600	3 800	4 000
901	-	950	3 600	3 900	4 100	4 300
951	-	1 000	3 800	4 100	4 300	4 500
1 001	-	1 100	4 100	4 400	4 600	4 900
1 101	-	1 200	4 600	4 900	5 000	5 000
1 201 and above			5 000	5 000	5 000	5 000

Table 3.A: CAT I, APV, NPA — aeroplanes**Minimum and maximum applicable RVR/CMV (lower and upper cut-off limits)**

Facility/conditions	RVR/CMV (m)	Aeroplane category			
		A	B	C	D
ILS, MLS, GLS, PAR, GNSS/SBAS, GNSS/VNAV	Min	According to Table 2			
	Max	1 500	1 500	2 400	2 400
NDB, NDB/DME, VOR, VOR/DME, LOC, LOC/DME, VDF, SRA, GNSS/LNAV with a procedure that fulfils the criteria in GM3 NCO.OP.110 (a)(2)	Min	750	750	750	750
	Max	1 500	1 500	2 400	2 400
For NDB, NDB/DME, VOR, VOR/DME, LOC, LOC/DME, VDF, SRA, GNSS/LNAV: — not fulfilling the criteria in GM3 NCO.OP.110 (a)(2), or — with a DH or MDH \geq 1 200 ft	Min	1 000	1 000	1 200	1 200
	Max	According to Table 2 if flown using the CDFA technique, otherwise an add-on of 200/400 m applies to the values in Table 2 but not to result in a value exceeding 5 000 m.			

DETERMINATION OF RVR/CMV/VIS MINIMA FOR NPA, CAT I — HELICOPTERS

- (a) For non-precision approach (NPA) operations, the minima specified in Table 4.1.H should apply:
- (1) where the missed approach point is within $\frac{1}{2}$ NM of the landing threshold, the approach minima specified for FALS may be used regardless of the length of approach lights available. However, FATO/runway edge lights, threshold lights, end lights and FATO/runway markings are still required;
 - (2) for night operations, ground lights should be available to illuminate the FATO/runway and any obstacles; and
 - (3) for single-pilot operations, the minimum RVR is 800 m or the minima in Table 2, whichever is higher.
- (b) For CAT I operations, the minima specified in Table 4.2.H should apply:
- (1) for night operations, ground light should be available to illuminate the FATO/runway and any obstacles;
 - (2) for single-pilot operations, the minimum RVR/VIS should be calculated in accordance with the following additional criteria:
 - (i) an RVR of less than 800 m should not be used except when using a suitable autopilot coupled to an ILS, MLS or GLS, in which case normal minima apply; and

- (ii) the DH applied should not be less than 1.25 times the minimum use height for the autopilot.

Table 4.1.H: Onshore NPA minima

MDH (ft) *	Facilities vs. RVR/CMV (m) **, ***			
	FALS	IALS	BALS	NALS
250 – 299	600	800	1 000	1 000
300 – 449	800	1 000	1 000	1 000
450 and above	1 000	1 000	1 000	1 000

*: The MDH refers to the initial calculation of MDH. When selecting the associated RVR, there is no need to take account of a rounding up to the nearest 10 ft, which may be done for operational purposes, e.g. conversion to MDA.

** : The tables are only applicable to conventional approaches with a nominal descent slope of not greater than 4°. Greater descent slopes will usually require that visual glide slope guidance (e.g. precision path approach indicator (PAPI)) is also visible at the MDH.

***: FALS comprise FATO/runway markings, 720 m or more of high intensity/medium intensity (HI/MI) approach lights, FATO/runway edge lights, threshold lights and FATO/runway end lights. Lights to be on.

IALS comprise FATO/runway markings, 420 – 719 m of HI/MI approach lights, FATO/runway edge lights, threshold lights and FATO/runway end lights. Lights to be on.

BALS comprise FATO/runway markings, < 420 m of HI/MI approach lights, any length of low intensity (LI) approach lights, FATO/runway edge lights, threshold lights and FATO/runway end lights. Lights to be on.

NALS comprise FATO/runway markings, FATO/runway edge lights, threshold lights, FATO/runway end lights or no lights at all.

Table 4.2.H: Onshore CAT I minima

DH (ft) *	Facilities vs. RVR/CMV (m) **, ***			
	FALS	IALS	BALS	NALS
200	500	600	700	1 000
201 – 250	550	650	750	1 000
251 – 300	600	700	800	1 000
301 and above	750	800	900	1 000

*: The DH refers to the initial calculation of DH. When selecting the associated RVR, there is no need to take account of a rounding up to the nearest 10 ft, which may be done for operational purposes, e.g. conversion to DA.

** : The table is applicable to conventional approaches with a glide slope up to and including 4°.

***: FALS comprise FATO/runway markings, 720 m or more of HI/MI approach lights, FATO/runway edge lights, threshold lights and FATO/runway end lights. Lights to be on.

IALS comprise FATO/runway markings, 420 – 719 m of HI/MI approach lights, FATO/runway edge lights, threshold lights and FATO/runway end lights. Lights to be on.

BALS comprise FATO/runway markings, < 420 m of HI/MI approach lights, any length of LI approach lights, FATO/runway edge lights, threshold lights and FATO/runway end lights. Lights to be on.

NALS comprise FATO/runway markings, FATO/runway edge lights, threshold lights, FATO/runway end lights or no lights at all.

GM5 NCO.OP.110 Aerodrome operating minima — aeroplanes and helicopters

CONVERSION OF REPORTED METEOROLOGICAL VISIBILITY TO RVR/CMV

- (a) A conversion from meteorological visibility to RVR/CMV should not be used:
- (1) when reported RVR is available;
 - (2) for calculating take-off minima; and
 - (3) for other RVR minima less than 800 m.
- (b) If the RVR is reported as being above the maximum value assessed by the aerodrome operator, e.g. 'RVR more than 1 500 m', it should not be considered as a reported value.
- (c) For all other circumstances, Table 5 should be used.

Table 5: Conversion of reported meteorological visibility to RVR/CMV

Lighting elements in operation	RVR/CMV = reported meteorological visibility x	
	Day	Night
High intensity (HI) approach and runway lights	1.5	2.0
Any type of light installation other than above	1.0	1.5
No lights	1.0	not applicable

GM6 NCO.OP.110 Aerodrome operating minima — aeroplanes and helicopters

AIRCRAFT CATEGORIES

- (a) Aircraft categories should be based on the indicated airspeed at threshold (V_{AT}), which is equal to the stalling speed (V_{SO}) multiplied by 1.3 or where published 1-g (gravity) stall speed (V_{S1g}) multiplied by 1.23 in the landing configuration at the maximum certified landing mass. If both V_{SO} and V_{S1g} are available, the higher resulting V_{AT} should be used.
- (b) The aircraft categories specified in the Table 6 should be used.

Table 6: Aircraft categories corresponding to VAT values

Aircraft category	V _{AT}
A	Less than 91 kt
B	from 91 to 120 kt
C	from 121 to 140 kt
D	from 141 to 165 kt
E	from 166 to 210 kt

GM7 NCO.OP.110 Aerodrome operating minima — aeroplanes and helicopters

CONTINUOUS DESCENT FINAL APPROACH (CDFA) — AEROPLANES

(a) Introduction

- (1) Controlled flight into terrain (CFIT) is a major hazard in aviation. Most CFIT accidents occur in the final approach segment of non-precision approaches; the use of stabilised-approach criteria on a continuous descent with a constant, predetermined vertical path is seen as a major improvement in safety during the conduct of such approaches. The following techniques are adopted as widely as possible, for all approaches.
- (2) The elimination of level flight segments at MDA close to the ground during approaches, and the avoidance of major changes in attitude and power/thrust close to the runway that can destabilise approaches, are seen as ways to reduce operational risks significantly.
- (3) The term CDFA has been selected to cover a flight technique for any type of NPA operation.
- (4) The advantages of CDFA are as follows:
 - (i) the technique enhances safe approach operations by the utilisation of standard operating practices;
 - (ii) the technique is similar to that used when flying an ILS approach, including when executing the missed approach and the associated missed approach procedure manoeuvre;
 - (iii) the aeroplane attitude may enable better acquisition of visual cues;
 - (iv) the technique may reduce pilot workload;
 - (v) the approach profile is fuel efficient;
 - (vi) the approach profile affords reduced noise levels; and
 - (vii) the technique affords procedural integration with APV operations.

(b) CDFA

- (1) Continuous descent final approach is defined in Annex I to the Regulation on Air operations.

- (2) An approach is only suitable for application of a CDFA technique when it is flown along a nominal vertical profile; a nominal vertical profile is not forming part of the approach procedure design, but can be flown as a continuous descent. The nominal vertical profile information may be published or displayed on the approach chart to the pilot by depicting the nominal slope or range/distance vs. height. Approaches with a nominal vertical profile are considered to be:
- (i) NDB, NDB/DME (non-directional beacon/distance measuring equipment);
 - (ii) VOR (VHF omnidirectional radio range), VOR/DME;
 - (iii) LOC (localiser), LOC/DME;
 - (iv) VDF (VHF direction finder), SRA (surveillance radar approach); and
 - (v) GNSS/LNAV (global navigation satellite system/lateral navigation).
- (3) Stabilised approach (SAP) is defined in Annex I to the Regulation on Air operations.
- (i) The control of the descent path is not the only consideration when using the CDFA technique. Control of the aeroplane's configuration and energy is also vital to the safe conduct of an approach.
 - (ii) The control of the flight path, described above as one of the requirements for conducting an SAP, should not be confused with the path requirements for using the CDFA technique.
 - (iii) The predetermined approach slope requirements for applying the CDFA technique are established by the following:
 - (A) the published 'nominal' slope information when the approach has a nominal vertical profile; and
 - (B) the designated final-approach segment minimum of 3 NM, and maximum, when using timing techniques, of 8 NM.
 - (iv) An SAP will never have any level segment of flight at DA/H or MDA/H, as applicable. This enhances safety by mandating a prompt missed approach procedure manoeuvre at DA/H or MDA/H.
 - (v) An approach using the CDFA technique will always be flown as an SAP, since this is a requirement for applying CDFA. However, an SAP does not have to be flown using the CDFA technique, for example a visual approach.

GM8 NCO.OP.110 Aerodrome operating minima — aeroplanes and helicopters

ONSHORE AERODROME DEPARTURE PROCEDURES — HELICOPTERS

The cloud base and visibility should be such as to allow the helicopter to be clear of cloud at the take-off decision point (TDP), and for the pilot flying to remain in sight of the surface until reaching the minimum speed for flight in instrument meteorological conditions, as given in the AFM.

NCO.OP.111 Aerodrome operating minima — NPA, APV, CAT I operations

- (a) The decision height (DH) to be used for a non-precision approach (NPA) flown with the continuous descent final approach (CDFA) technique, approach procedure with vertical guidance (APV) or category I (CAT I) operation shall not be lower than the highest of:
- (1) the minimum height to which the approach aid can be used without the required visual reference;
 - (2) the obstacle clearance height (OCH) for the category of aircraft;
 - (3) the published approach procedure DH where applicable;
 - (4) the system minimum specified in Table 1; or
 - (5) the minimum DH specified in the AFM or equivalent document, if stated.
- (b) The minimum descent height (MDH) for an NPA operation flown without the CDFA technique shall not be lower than the highest of:
- (1) the OCH for the category of aircraft;
 - (2) the system minimum specified in Table 1; or
 - (3) the minimum MDH specified in the AFM, if stated.

Table 1**System minima**

Facility	Lowest DH/MDH (ft)
Instrument landing system (ILS)	200
Global navigation satellite system (GNSS)/Satellite-based augmentation system (SBAS) (Lateral precision with vertical guidance approach (LPV))	200
GNSS (Lateral Navigation (LNAV))	250
GNSS/Baro-vertical navigation (VNAV) (LNAV/VNAV)	250
Localiser (LOC) with or without distance measuring equipment (DME)	250
Surveillance radar approach (SRA) (terminating at ½ NM)	250
SRA (terminating at 1 NM)	300
SRA (terminating at 2 NM or more)	350
VHF omnidirectional radio range (VOR)	300
VOR/DME	250
Non-directional beacon (NDB)	350
NDB/DME	300

VHF direction finder (VDF)	350
----------------------------	-----

AMC1 NCO.OP.111 Aerodrome operating minima — NPA, APV, CAT I operations

NPA FLOWN WITH THE CDFA TECHNIQUE

When flying a non-precision approach operation using the CDFA technique, the pilot-in-command should ensure that when executing a missed approach, the initiation of the go-around is done at or above the DA/H to avoid flying below the MDA/H.

NCO.OP.112 Aerodrome operating minima — circling operations with aeroplanes

- (a) The MDH for a circling operation with aeroplanes shall not be lower than the highest of:
- (1) the published circling OCH for the aeroplane category;
 - (2) the minimum circling height derived from Table 1; or
 - (3) the DH/MDH of the preceding instrument approach procedure.
- (b) The minimum visibility for a circling operation with aeroplanes shall be the highest of:
- (1) the circling visibility for the aeroplane category, if published;
 - (2) the minimum visibility derived from Table 2; or
 - (3) the runway visual range/converted meteorological visibility (RVR/CMV) of the preceding instrument approach procedure.

Table 1**MDH and minimum visibility for circling vs. aeroplane category**

	Aeroplane category			
	A	B	C	D
MDH (ft)	400	500	600	700
Minimum meteorological visibility (m)	1500	1600	2400	3600

GM1 NCO.OP.112 Aerodrome operating minima — circling operations with aeroplanes

SUPPLEMENTAL INFORMATION

- (a) The purpose of this Guidance Material is to provide pilots with supplemental information regarding the application of aerodrome operating minima in relation to circling approaches.
- (b) Conduct of flight — general:
- (1) the MDH and obstacle clearance height (OCH) included in the procedure are referenced to aerodrome elevation;
 - (2) the MDA is referenced to mean sea level; and
 - (3) for these procedures, the applicable visibility is the meteorological visibility.
- (c) Instrument approach followed by visual manoeuvring (circling) without prescribed tracks:
- (1) When the aeroplane is on the initial instrument approach, before visual reference is stabilised, but not below MDA/H — the aeroplane should follow the corresponding instrument approach procedure until the appropriate instrument MAPt is reached.
 - (2) At the beginning of the level flight phase at or above the MDA/H, the instrument approach track determined by radio navigation aids, RNAV, RNP or ILS, microwave landing system (MLS) or GBAS landing system (GLS) should be maintained until the pilot:
 - (i) estimates that, in all probability, visual contact with the runway of intended landing or the runway environment will be maintained during the entire circling procedure;

- (ii) estimates that the aeroplane is within the circling area before commencing circling; and
 - (iii) is able to determine the aeroplane's position in relation to the runway of intended landing with the aid of the appropriate external references.
 - (3) When reaching the published instrument MAPt and the conditions stipulated in (c)(2) are unable to be established by the pilot, a missed approach should be carried out in accordance with that instrument approach procedure.
 - (4) After the aeroplane has left the track of the initial instrument approach, the flight phase outbound from the runway should be limited to an appropriate distance, which is required to align the aeroplane onto the final approach. Such manoeuvres should be conducted to enable the aeroplane:
 - (i) to attain a controlled and stable descent path to the intended landing runway; and
 - (ii) to remain within the circling area and in such a way that visual contact with the runway of intended landing or runway environment is maintained at all times.
 - (5) Flight manoeuvres should be carried out at an altitude/height that is not less than the circling MDA/H.
 - (6) Descent below MDA/H should not be initiated until the threshold of the runway to be used has been appropriately identified. The aeroplane should be in a position to continue with a normal rate of descent and land within the touchdown zone.
- (d) Instrument approach followed by a visual manoeuvring (circling) with prescribed track:
- (1) The aeroplane should remain on the initial instrument approach procedure until one of the following is reached:
 - (i) the prescribed divergence point to commence circling on the prescribed track; or
 - (ii) the MAPt.
 - (2) The aeroplane should be established on the instrument approach track determined by the radio navigation aids, RNAV, RNP, or ILS, MLS or GLS in level flight at or above the MDA/H at or by the circling manoeuvre divergence point.
 - (3) If the divergence point is reached before the required visual reference is acquired, a missed approach should be initiated not later than the MAPt and completed in accordance with the initial instrument approach procedure.
 - (4) When commencing the prescribed circling manoeuvre at the published divergence point, the subsequent manoeuvres should be conducted to comply with the published routing and published heights/altitudes.
 - (5) Unless otherwise specified, once the aeroplane is established on the prescribed track(s), the published visual reference does not need to be maintained unless:
 - (i) required by the State of the aerodrome; or
 - (ii) the circling MAPt (if published) is reached.
 - (6) If the prescribed circling manoeuvre has a published MAPt and the required visual reference has not been obtained by that point, a missed approach should be executed in accordance with (e)(2) and (e)(3).
 - (7) Subsequent further descent below MDA/H should only commence when the required visual reference has been obtained.

- (8) Unless otherwise specified in the procedure, final descent should not be commenced from MDA/H until the threshold of the intended landing runway has been identified and the aeroplane is in a position to continue with a normal rate of descent to land within the touchdown zone.
- (e) Missed approach:
- (1) Missed approach during the instrument procedure prior to circling:
 - (i) if the missed approach is required to be flown when the aeroplane is positioned on the instrument approach track defined by radio navigation aids, RNAV, RNP or ILS, MLS or GLS and before commencing the circling manoeuvre, the published missed approach for the instrument approach should be followed; or
 - (ii) if the instrument approach procedure is carried out with the aid of an ILS, MLS or a stabilised approach (SAp), the MAPt associated with an ILS or MLS procedure without glide path (GP-out procedure) or the SAp, where applicable, should be used.
 - (2) If a prescribed missed approach is published for the circling manoeuvre, this overrides the manoeuvres prescribed below.
 - (3) If visual reference is lost while circling to land after the aeroplane has departed from the initial instrument approach track, the missed approach specified for that particular instrument approach should be followed. It is expected that the pilot will make an initial climbing turn toward the intended landing runway to a position overhead of the aerodrome where the pilot will establish the aeroplane in a climb on the instrument missed approach segment.
 - (4) The aeroplane should not leave the visual manoeuvring (circling) area, which is obstacle protected, unless:
 - (i) established on the appropriate missed approach procedure; or
 - (ii) at minimum sector altitude (MSA).
 - (5) All turns should be made in the same direction and the aeroplane should remain within the circling protected area while climbing either:
 - (i) to the altitude assigned to any published circling missed approach manoeuvre if applicable;
 - (ii) to the altitude assigned to the missed approach of the initial instrument approach;
 - (iii) to the MSA;
 - (iv) to the minimum holding altitude (MHA) applicable for transition to a holding facility or fix, or continue to climb to an MSA; or
 - (v) as directed by ATS.

When the missed approach procedure is commenced on the 'downwind' leg of the circling manoeuvre, an 'S' turn may be undertaken to align the aeroplane on the initial instrument approach missed approach path, provided the aeroplane remains within the protected circling area.

The pilot-in-command should be responsible for ensuring adequate terrain clearance during the above-stipulated manoeuvres, particularly during the execution of a missed approach initiated by ATS.

-
- (6) Because the circling manoeuvre may be accomplished in more than one direction, different patterns will be required to establish the aeroplane on the prescribed missed approach course, depending on its position at the time visual reference is lost. In particular, all turns are to be in the prescribed direction if this is restricted, e.g. to the west/east (left or right hand) to remain within the protected circling area.
 - (7) If a missed approach procedure is published for a particular runway onto which the aeroplane is conducting a circling approach and the aeroplane has commenced a manoeuvre to align with the runway, the missed approach for this direction may be accomplished. The ATS unit should be informed of the intention to fly the published missed approach procedure for that particular runway.
 - (8) The pilot-in-command should advise ATS when any missed approach procedure has been commenced, the height/altitude the aeroplane is climbing to and the position the aeroplane is proceeding towards and/or heading the aeroplane is established on.

NCO.OP.113 Aerodrome operating minima — onshore circling operations with helicopters

The MDH for an onshore circling operation with helicopters shall not be lower than 250 ft and the meteorological visibility not less than 800 m.

NCO.OP.115 Departure and approach procedures — aeroplanes and helicopters

- (a) The pilot-in-command shall use the departure and approach procedures established by the State of the aerodrome, if such procedures have been published for the runway or FATO to be used.
- (b) The pilot-in-command may deviate from a published departure route, arrival route or approach procedure:
 - (1) provided obstacle clearance criteria can be observed, full account is taken of the operating conditions and any ATC clearance is adhered to; or
 - (2) when being radar-vectorred by an ATC unit.

NCO.OP.116 Performance-based navigation — aeroplanes and helicopters

The pilot-in-command shall ensure that, when PBN is required for the route or procedure to be flown:

- (a) the relevant PBN navigation specification is stated in the AFM or other document that has been approved by the certifying authority as part of an airworthiness assessment or is based on such approval; and
- (b) the aircraft is operated in conformance with the relevant navigation specification and limitations in the AFM or other document mentioned above.

AMC1 NCO.OP.116 Performance-based navigation — aeroplanes and helicopters

PBN OPERATIONS

For operations where a navigation specification for performance-based navigation (PBN) has been prescribed and no specific approval is required in accordance with SPA.PBN.100, the pilot-in-command should:

- (a) use operating procedures specifying:
 - (1) normal, abnormal and contingency procedures;
 - (2) electronic navigation database management; and
 - (3) relevant entries in the minimum equipment list (MEL), where applicable;
- (b) ensure that he/she is appropriately trained for the intended operation.

AMC2 NCO.OP.116 Performance-based navigation — aeroplanes and helicopters

MONITORING AND VERIFICATION

- (a) Preflight and general considerations
 - (1) At navigation system initialisation, the pilot-in-command should confirm that the navigation database is current and verify that the aircraft position, if required, has been entered correctly.
 - (2) The active flight plan, if applicable, should be checked by comparing the charts or other applicable documents with navigation equipment and displays. This includes confirmation

of the waypoint sequence, reasonableness of track angles and distances, any altitude or speed constraints, and, where possible, which waypoints are fly-by and which are fly-over. Where relevant, the RF leg arc radii should be confirmed.

- (3) The pilot-in-command should check that the navigation aids critical to the operation of the intended PBN procedure are available.
 - (4) The pilot-in-command should confirm the navigation aids that should be excluded from the operation, if any.
 - (5) An arrival, approach or departure procedure should not be used if the validity of the procedure in the navigation database has expired.
- (b) Departure
- (1) Prior to commencing a take-off on a PBN procedure, the pilot-in-command should verify that the area navigation system is available and operating correctly and the correct aerodrome and runway data has been loaded. A positive check should be made that the indicated aircraft position is consistent with the actual aircraft position at the start of the take-off roll (aeroplanes) or lift-off (helicopters).
 - (2) Where GNSS is used, the signal should be acquired before the take-off roll (aeroplanes) or lift-off (helicopters) commences.
 - (3) Unless automatic updating of the actual departure point is provided, the pilot-in-command should ensure initialisation on the runway or FATO either by means of a manual runway threshold or intersection update, as applicable. This is to preclude any inappropriate or inadvertent position shift after take-off.
- (c) Arrival and approach
- (1) The pilot-in-command should verify that the navigation system is operating correctly and the correct arrival procedure and runway (including any applicable transition) are entered and properly depicted.
 - (2) Any published altitude and speed constraints should be observed.
 - (3) The pilot-in-command should check approach procedures (including alternate aerodromes if needed) as extracted by the system (e.g. CDU flight plan page) or presented graphically on the moving map, in order to confirm the correct loading and the reasonableness of the procedure content.
 - (4) Prior to commencing the approach operation (before the IAF), the pilot-in-command should verify the correctness of the loaded procedure by comparison with the appropriate approach charts. This check should include:
 - (i) the waypoint sequence;
 - (ii) reasonableness of the tracks and distances of the approach legs and the accuracy of the inbound course; and
 - (iii) the vertical path angle, if applicable.
- (d) Altimetry settings for RNP APCH operations using Baro VNAV
- (1) Barometric settings
 - (i) The pilot-in-command should set and confirm the correct altimeter setting and check that the two altimeters provide altitude values that do not differ more than 100 ft at the most at or before the FAF.

- (ii) The pilot-in-command should fly the procedure with:
 - (A) a current local altimeter setting source available — a remote or regional altimeter setting source should not be used; and
 - (B) the QNH/QFE, as appropriate, set on the aircraft's altimeters.
- (2) Temperature compensation
 - (i) For RNP APCH operations to LNAV/VNAV minima using Baro VNAV:
 - (A) the pilot-in-command should not commence the approach when the aerodrome temperature is outside the promulgated aerodrome temperature limits for the procedure, unless the area navigation system is equipped with approved temperature compensation for the final approach;
 - (B) when the temperature is within promulgated limits, the pilot-in-command should not make compensation to the altitude at the FAF; and
 - (C) since only the final approach segment is protected by the promulgated aerodrome temperature limits, the pilot-in-command should consider the effect of temperature on terrain and obstacle clearance in other phases of flight.
 - (ii) For RNP APCH operations to LNAV minima using Baro VNAV:
 - (A) the pilot-in-command should consider the effect of temperature on terrain and obstacle clearance in all phases of flight, in particular on any step-down fix;
 - (B) if the temperature is outside promulgated limits for RNP APCH to LNAV/VNAV minima, the pilot-in-command should not use a Baro VNAV function for vertical guidance, unless the area navigation system is equipped with approved temperature compensation for the final approach.
- (e) Sensor and lateral navigation accuracy selection
 - (1) For multi-sensor systems, the pilot-in-command should verify, during the approach, that the GNSS sensor is used for position computation.
 - (2) For aircraft with RNP input selection capability, the pilot-in-command should confirm that the indicated RNP value is appropriate for the PBN operation.

AMC3 NCO.OP.116 Performance-based navigation — aeroplanes and helicopters

MANAGEMENT OF THE NAVIGATION DATABASE

- (a) For RNAV 1, RNAV 2, RNP 1, RNP 2, and RNP APCH, the pilot-in-command should neither insert nor modify waypoints by manual entry into a procedure (departure, arrival or approach) that has been retrieved from the database. User-defined data may be entered and used for waypoint altitude/speed constraints on a procedure where said constraints are not included in the navigation database coding.
- (b) For RNP 4 operations, the pilot-in-command should not modify waypoints that have been retrieved from the database. User-defined data (e.g. for flex-track routes) may be entered and used.
- (c) The lateral and vertical definition of the flight path between the FAF and the missed approach point (MAPt) retrieved from the database should not be revised by the pilot-in-command.

AMC4 NCO.OP.116 Performance-based navigation — aeroplanes and helicopters

DISPLAYS AND AUTOMATION

- (a) For RNAV 1, RNP 1, and RNP APCH operations, the pilot-in-command should use a lateral deviation indicator, and where available, flight director and/or autopilot in lateral navigation mode.
- (b) The appropriate displays should be selected so that the following information can be monitored:
 - (1) the computed desired path;
 - (2) aircraft position relative to the lateral path (cross-track deviation) for FTE monitoring; and
 - (3) aircraft position relative to the vertical path (for a 3D operation).
- (c) The pilot-in-command of an aircraft with a lateral deviation indicator (e.g. CDI) should ensure that lateral deviation indicator scaling (full-scale deflection) is suitable for the navigation accuracy associated with the various segments of the procedure.
- (d) The pilot-in-command should maintain procedure centrelines unless authorised to deviate by ATC or demanded by emergency conditions.
- (e) Cross-track error/deviation (the difference between the area-navigation-system-computed path and the aircraft-computed position) should normally be limited to $\pm \frac{1}{2}$ time the RNAV/RNP value associated with the procedure. Brief deviations from this standard (e.g. overshoots or undershoots during and immediately after turns) up to a maximum of 1 time the RNAV/RNP value should be allowable.
- (f) For a 3D approach operation, the pilot-in-command should use a vertical deviation indicator and, where required by AFM/POH limitations, a flight director or autopilot in vertical navigation mode.
- (g) Deviations below the vertical path should not exceed 75 ft at any time, or half-scale deflection where angular deviation is indicated, and not more than 75 ft above the vertical profile, or half-scale deflection where angular deviation is indicated, at or below 1 000 ft above aerodrome level. The pilot-in-command should execute a missed approach if the vertical deviation exceeds this criterion, unless the pilot-in-command has in sight the visual references required to continue the approach.

AMC5 NCO.OP.116 Performance-based navigation — aeroplanes and helicopters

VECTORING AND POSITIONING

- (a) ATC tactical interventions in the terminal area may include radar headings, 'direct to' clearances which bypass the initial legs of an approach procedure, interceptions of an initial or intermediate segments of an approach procedure or the insertion of additional waypoints loaded from the database.
- (b) In complying with ATC instructions, the pilot-in-command should be aware of the implications for the navigation system.
- (c) 'Direct to' clearances may be accepted to the IF provided that it is clear to the pilot-in-command that the aircraft will be established on the final approach track at least 2 NM before the FAF.
- (d) 'Direct to' clearance to the FAF should not be acceptable. Modifying the procedure to intercept the final approach track prior to the FAF should be acceptable for radar-vectorred arrivals or otherwise only with ATC approval.

- (e) The final approach trajectory should be intercepted no later than the FAF in order for the aircraft to be correctly established on the final approach track before starting the descent (to ensure terrain and obstacle clearance).
- (f) 'Direct to' clearances to a fix that immediately precede an RF leg should not be permitted.
- (g) For parallel offset operations en route in RNP 4 and A-RNP, transitions to and from the offset track should maintain an intercept angle of no more than 45° unless specified otherwise by ATC.

AMC6 NCO.OP.116 Performance-based navigation — aeroplanes and helicopters

ALERTING AND ABORT

- (a) Unless the pilot-in-command has sufficient visual reference to continue the approach operation to a safe landing, an RNP APCH operation should be discontinued if:
 - (1) navigation system failure is annunciated (e.g. warning flag);
 - (2) lateral or vertical deviations exceed the tolerances; and
 - (3) loss of the on-board monitoring and alerting system.
- (b) Discontinuing the approach operation may not be necessary for a multi-sensor navigation system that includes demonstrated RNP capability without GNSS in accordance with the AFM/POH.
- (c) Where vertical guidance is lost while the aircraft is still above 1 000 ft AGL, the pilot-in-command may decide to continue the approach to LNAV minima, when supported by the navigation system.

AMC7 NCO.OP.116 Performance-based navigation — aeroplanes and helicopters

CONTINGENCY PROCEDURES

- (a) The pilot-in-command should make the necessary preparation to revert to a conventional arrival procedure where appropriate. The following conditions should be considered:
 - (1) failure of the navigation system components including navigation sensors, and a failure effecting flight technical error (e.g. failures of the flight director or autopilot);
 - (2) multiple system failures affecting aircraft performance;
 - (3) coasting on inertial sensors beyond a specified time limit; and
 - (4) RAIM (or equivalent) alert or loss of integrity function.
- (b) In the event of loss of PBN capability, the pilot-in-command should invoke contingency procedures and navigate using an alternative means of navigation.
- (c) The pilot-in-command should notify ATC of any problem with PBN capability.
- (d) In the event of communication failure, the pilot-in-command should continue with the operation in accordance with published lost communication procedures.

AMC8 NCO.OP.116 Performance-based navigation — aeroplanes and helicopters

RNAV 10

- (a) Operating procedures and routes should take account of the RNAV 10 time limit declared for the inertial system, if applicable, considering also the effect of weather conditions that could affect flight duration in RNAV 10 airspace.
- (b) The operator may extend RNAV 10 inertial navigation time by position updating. The operator should calculate, using statistically-based typical wind scenarios for each planned route, points at which updates can be made, and the points at which further updates will not be possible.

GM1 NCO.OP.116 Performance-based navigation — aeroplanes and helicopters

DESCRIPTION

- (a) For both, RNP X and RNAV X designations, the 'X' (where stated) refers to the lateral navigation accuracy (total system error) in NM, which is expected to be achieved at least 95 % of the flight time by the population of aircraft operating within the airspace, route or procedure. For RNP APCH and A-RNP, the lateral navigation accuracy depends on the segment.
- (b) PBN may be required on notified routes, for notified procedures and in notified airspace.

RNAV 10

- (c) For purposes of consistency with the PBN concept, this Regulation is using the designation 'RNAV 10' because this specification does not include on-board performance monitoring and alerting.
- (d) However, it should be noted that many routes still use the designation 'RNP 10' instead of 'RNAV 10'. 'RNP 10' was used as designation before the publication of the fourth edition of ICAO Doc 9613 in 2013. The terms 'RNP 10' and 'RNAV 10' should be considered equivalent.

NCO.OP.120 Noise abatement procedures — aeroplanes, helicopters and powered sailplanes

The pilot-in-command shall take into account published noise abatement procedures to minimise the effect of aircraft noise while ensuring that safety has priority over noise abatement.

NCO.OP.121 Noise abatement procedures — balloons

The pilot-in-command shall take into account operating procedures to minimise the effect of heating-system noise while ensuring that safety has priority over noise abatement.

NCO.OP.125 Fuel and oil supply — aeroplanes

- (a) The pilot-in-command shall only commence a flight if the aeroplane carries sufficient fuel and oil for the following:
- (1) for visual flight rules (VFR) flights:
 - (i) by day, taking-off and landing at the same aerodrome/landing site and always remaining in sight of that aerodrome/landing site, to fly the intended route and thereafter for at least 10 minutes at normal cruising altitude;
 - (ii) by day, to fly to the aerodrome of intended landing and thereafter to fly for at least 30 minutes at normal cruising altitude; or
 - (iii) by night, to fly to the aerodrome of intended landing and thereafter to fly for at least 45 minutes at normal cruising altitude;
 - (2) for IFR flights:
 - (i) when no destination alternate is required, to fly to the aerodrome of intended landing and thereafter to fly for at least 45 minutes at normal cruising altitude; or
 - (ii) when a destination alternate is required, to fly to the aerodrome of intended landing, to an alternate aerodrome and thereafter to fly for at least 45 minutes at normal cruising altitude.
- (b) In computing the fuel required including to provide for contingency, the following shall be taken into consideration:
- (1) forecast meteorological conditions;
 - (2) anticipated ATC routings and traffic delays;
 - (3) procedures for loss of pressurisation or failure of one engine while en-route, where applicable; and
 - (4) any other condition that may delay the landing of the aeroplane or increase fuel and/or oil consumption.
- (c) Nothing shall preclude amendment of a flight plan in-flight, in order to re-plan the flight to another destination, provided that all requirements can be complied with from the point where the flight is re-planned.

NCO.OP.126 Fuel and oil supply — helicopters

- (a) The pilot-in-command shall only commence a flight if the helicopter carries sufficient fuel and oil for the following:
- (1) for VFR flights, to fly to the aerodrome/operating site of intended landing and thereafter to fly for at least 20 minutes at best-range-speed; and

-
- (2) for IFR flights:
- (i) when no alternate is required or no weather-permissible alternate aerodrome is available, to fly to the aerodrome/operating site of intended landing, and thereafter to fly for 30 minutes at holding speed at 450 m (1 500 ft) above the destination aerodrome/operating site under standard temperature conditions and approach and land; or
 - (ii) when an alternate is required, to fly to and execute an approach and a missed approach at the aerodrome/operating site of intended landing, and thereafter:
 - (A) to fly to the specified alternate; and
 - (B) to fly for 30 minutes at holding speed at 450 m (1 500 ft) above the alternate aerodrome/operating site under standard temperature conditions and approach and land.
- (b) In computing the fuel required including to provide for contingency, the following shall be taken into consideration:
- (1) forecast meteorological conditions;
 - (2) anticipated ATC routings and traffic delays;
 - (3) procedures for loss of pressurisation or failure of one engine while en-route, where applicable; and
 - (4) any other condition that may delay the landing of the aircraft or increase fuel and/or oil consumption.
- (c) Nothing shall preclude amendment of a flight plan in-flight, in order to re-plan the flight to another destination, provided that all requirements can be complied with from the point where the flight is re-planned.

NCO.OP.127 Fuel and ballast supply and planning — balloons

- (a) The pilot-in-command shall only commence a flight if the reserve fuel or ballast is sufficient for 30 minutes of flight.
- (b) Fuel or ballast supply calculations shall be based upon at least the following operating conditions under which the flight is to be conducted:
- (1) data provided by the balloon manufacturer;
 - (2) anticipated masses;
 - (3) expected meteorological conditions; and
 - (4) air navigation services provider procedures and restrictions.

NCO.OP.130 Passenger briefing

The pilot-in-command shall ensure that before or, where appropriate, during the flight, passengers are given a briefing on emergency equipment and procedures.

AMC1 NCO.OP.130 Passenger briefing

GENERAL

- (a) Except for sailplanes and balloons, the briefing should include the locations and use of seat belts and if applicable:
- (1) emergency exits;
 - (2) passenger emergency briefing cards;
 - (3) life-jackets;
 - (4) oxygen dispensing equipment;
 - (5) life rafts; and
 - (6) other emergency equipment provided for individual passenger use.
- (b) The briefing should also include the location and general manner of use of the principal emergency equipment carried for collective use.

SAILPLANES

- (c) The briefing should include the locations and use of seat belts and if applicable:
- (1) emergency canopy opening;
 - (2) use of the parachute;
 - (3) oxygen dispensing equipment;
 - (4) passenger emergency briefing cards; and
 - (5) other emergency equipment provided for individual passenger use.

BALLOONS

- (d) Passengers should be given a verbal briefing and demonstration about safety matters in such a way that the information is easily retained and reproduced during the landing and in the case of an emergency situation.
- (e) The briefing/demonstration should contain the following items:
- (1) use of landing hand-holds;
 - (2) use of oxygen dispensing equipment;
 - (3) other emergency equipment provided for individual passenger use, if applicable;
 - (4) wearing of suitable clothing;
 - (5) smoking regulations and the use of portable electronic devices;
 - (6) stowage of baggage;
 - (7) importance to remain inside the basket at all times, particularly after landing;
 - (8) landing positions to be assumed to minimise the effect of the impact upon an emergency landing; and
 - (9) safe transport of the balloon on the ground after landing.
- (f) Part or all of the verbal briefing may be provided additionally by a safety briefing card on which pictorial instructions indicate the correct landing position.

- (g) Before take-off the correct landing position should be demonstrated.
- (h) Before commencing the landing phase, passengers should be required to practice the correct landing position.

NCO.OP.135 Flight preparation

- (a) Before commencing a flight, the pilot-in-command shall ascertain by every reasonable means available that the space-based facilities, ground and/or water facilities, including communication facilities and navigation aids available and directly required on such flight, for the safe operation of the aircraft, are adequate for the type of operation under which the flight is to be conducted.
- (b) Before commencing a flight, the pilot-in-command shall be familiar with all available meteorological information appropriate to the intended flight. Preparation for a flight away from the vicinity of the place of departure, and for every flight under IFR, shall include:
 - (1) a study of available current weather reports and forecasts; and
 - (2) the planning of an alternative course of action to provide for the eventuality that the flight cannot be completed as planned, because of weather conditions.

NCO.OP.140 Destination alternate aerodromes — aeroplanes

For IFR flights, the pilot-in-command shall specify at least one weather-permissible destination alternate aerodrome in the flight plan, unless:

- (a) the available current meteorological information indicates that, for the period from 1 hour before until 1 hour after the estimated time of arrival, or from the actual time of departure to 1 hour after the estimated time of arrival, whichever is the shorter period, the approach and landing may be made under visual meteorological conditions (VMC); or
- (b) the place of intended landing is isolated and:
 - (1) an instrument approach procedure is prescribed for the aerodrome of intended landing; and
 - (2) available current meteorological information indicates that the following meteorological conditions will exist from 2 hours before to 2 hours after the estimated time of arrival:
 - (i) a cloud base of at least 300 m (1 000 ft) above the minimum associated with the instrument approach procedure; and
 - (ii) visibility of at least 5,5 km or of 4 km more than the minimum associated with the procedure.

NCO.OP.141 Destination alternate aerodromes — helicopters

For IFR flights, the pilot-in-command shall specify at least one weather-permissible destination alternate aerodrome in the flight plan, unless:

- (a) an instrument approach procedure is prescribed for the aerodrome of intended landing and the available current meteorological information indicates that the following meteorological conditions will exist from 2 hours before to 2 hours after the estimated time of arrival, or from the actual time of departure to 2 hours after the estimated time of arrival, whichever is the shorter period:
 - (1) a cloud base of at least 120 m (400 ft) above the minimum associated with the instrument approach procedure; and
 - (2) visibility of at least 1 500 m more than the minimum associated with the procedure; or
- (b) the place of intended landing is isolated and:
 - (1) an instrument approach procedure is prescribed for the aerodrome of intended landing;

-
- (2) available current meteorological information indicates that the following meteorological conditions will exist from 2 hours before to 2 hours after the estimated time of arrival:
 - (i) the cloud base is at least 120 m (400 ft) above the minimum associated with the instrument approach procedure;
 - (ii) visibility is at least 1 500 m more than the minimum associated with the procedure; and
 - (3) a point of no return (PNR) is determined in case of an offshore destination.

NCO.OP.142 Destination aerodromes — instrument approach operations

The pilot-in-command shall ensure that sufficient means are available to navigate and land at the destination aerodrome or at any destination alternate aerodrome in the case of loss of capability for the intended approach and landing operation.

GM1 NCO.OP.142 Destination aerodromes — instrument approach operations**PBN OPERATIONS**

The pilot-in-command may only select an aerodrome as a destination alternate aerodrome if an instrument approach procedure that does not rely on GNSS is available either at that aerodrome or at the destination aerodrome.

NCO.OP.145 Refuelling with passengers embarking, on board or disembarking

- (a) The aircraft shall not be refuelled with aviation gasoline (AVGAS) or wide-cut type fuel or a mixture of these types of fuel, when passengers are embarking, on board or disembarking.
- (b) For all other types of fuel, the aircraft shall not be refuelled when passengers are embarking, on board or disembarking, unless it is attended by the pilot-in-command or other qualified personnel ready to initiate and direct an evacuation of the aircraft by the most practical and expeditious means available.

AMC1 NCO.OP.145 Refuelling with passengers embarking, on board or disembarking

OPERATIONAL PROCEDURES

If passengers are on board when refuelling with other than aviation gasoline (AVGAS), wide-cut type fuel or a mixture of these types of fuel, the following precautions should be taken:

- (a) the pilot-in-command should remain at a location during fuelling operations with passengers on board which allows him to handle emergency procedures concerning fire protection and fire-fighting and initiate and direct an evacuation;
- (b) personnel and passengers should be warned that refuelling will take place;
- (c) passengers should be instructed to unfasten their seat belts and refrain from smoking; and
- (d) if the presence of fuel vapour is detected inside the aircraft, or any other hazard arises during refuelling, fuelling should be stopped immediately.

NCO.OP.150 Carriage of passengers

Except for balloons, the pilot-in-command shall ensure that, prior to and during taxiing, take-off and landing, and whenever deemed necessary in the interest of safety, each passenger on board occupies a seat or berth and has his/her safety belt or restraint device properly secured.

AMC1 NCO.OP.150 Carriage of passengers**CARRIAGE OF CHILDREN AND PERSONS WITH REDUCED MOBILITY — BALLOONS**

The pilot-in-command may exclude children and/or persons with reduced mobility (PRM)s from transportation in a balloon, when:

- (a) their presence may impede:
 - (1) the crew in their duties;
 - (2) access to emergency equipment; or
 - (3) the emergency evacuation of the balloon;and/or
- (b) those persons are:
 - (1) unable to take a proper brace position; or
 - (2) smaller than the inner height of the basket wall.

NCO.OP.155 Smoking on board — aeroplanes and helicopters

The pilot-in-command shall not allow smoking on board:

- (a) whenever considered necessary in the interest of safety; and
- (b) during refuelling of the aircraft.

NCO.OP.156 Smoking on board — sailplanes and balloons

No person shall be allowed to smoke on board a sailplane or balloon.

NCO.OP.160 Meteorological conditions

- (a) The pilot-in-command shall only commence or continue a VFR flight if the latest available meteorological information indicates that the weather conditions along the route and at the intended destination at the estimated time of use will be at or above the applicable VFR operating minima.
- (b) The pilot-in-command shall only commence or continue an IFR flight towards the planned destination aerodrome if the latest available meteorological information indicates that, at the estimated time of arrival, the weather conditions at the destination or at least one destination alternate aerodrome are at or above the applicable aerodrome operating minima.
- (c) If a flight contains VFR and IFR segments, the meteorological information referred to in (a) and (b) shall be applicable as far as relevant.

AMC1 NCO.OP.160 Meteorological conditions**APPLICATION OF AERODROME FORECASTS (TAF & TREND) — AEROPLANES AND HELICOPTERS**

Where a terminal area forecast (TAF) or meteorological aerodrome or aeronautical report (METAR) with landing forecast (TREND) is used as forecast, the following criteria should be used:

- (a) From the start of a TAF validity period up to the time of applicability of the first subsequent 'FM...' or 'BECMG' or, if no 'FM' or 'BECMG' is given, up to the end of the validity period of the TAF, the prevailing weather conditions forecast in the initial part of the TAF should be applied.
- (b) From the time of observation of a METAR up to the time of applicability of the first subsequent 'FM...' or 'BECMG' or, if no 'FM' or 'BECMG' is given, up to the end of the validity period of the TREND, the prevailing weather conditions forecast in the METAR should be applied.
- (c) Following FM (alone) or BECMG AT, any specified change should be applied from the time of the change.
- (d) Following BECMG (alone), BECMG FM, BECMG TL, BECMG FM TL:
 - (1) in the case of deterioration, any specified change should be applied from the start of the change; and
 - (2) in the case of improvement, any specified change should be applied from the end of the change.
- (e) In a period indicated by TEMPO (alone), TEMPO FM, TEMPO TL, TEMPO FM TL, PROB30/40 (alone):
 - (1) deteriorations associated with persistent conditions in connection with e.g. haze, mist, fog, dust/sandstorm, continuous precipitation should be applied;

- (2) deteriorations associated with transient/showery conditions in connection with short-lived weather phenomena, e.g. thunderstorms, showers may be ignored; and
 - (3) improvements should in all cases be disregarded.
- (f) In a period indicated by PROB30/40 TEMPO:
- (1) deteriorations may be disregarded; and
 - (2) improvements should be disregarded.

Note: Abbreviations used in the context of this AMC are as follows:

FM: from

BECMG: becoming

AT: at

TL: till

TEMPO: temporarily

PROB: probability

GM1 NCO.OP.160 Meteorological conditions

CONTINUATION OF A FLIGHT — AEROPLANES AND HELICOPTERS

In the case of in-flight re-planning, continuation of a flight refers to the point from which a revised flight plan applies.

GM2 NCO.OP.160 Meteorological conditions

EVALUATION OF METEOROLOGICAL CONDITIONS — AEROPLANES AND HELICOPTERS

It is recommended that the pilot-in-command carefully evaluates the available meteorological information relevant to the proposed flight, such as applicable surface observations, winds, temperatures aloft, terminal and area forecasts, air meteorological information reports (AIRMETs), significant meteorological information (SIGMET) and pilot reports. The ultimate decision whether, when, and where to make the flight rests with the pilot-in-command. The pilot-in-command also should continue to re-evaluate changing weather conditions.

NCO.OP.165 Ice and other contaminants — ground procedures

The pilot-in-command shall only commence take-off if the aircraft is clear of any deposit that might adversely affect the performance or controllability of the aircraft, except as permitted in the AFM.

NCO.OP.170 Ice and other contaminants — flight procedures

- (a) The pilot-in-command shall only commence a flight or intentionally fly into expected or actual icing conditions if the aircraft is certified and equipped to cope with such conditions as referred to in 2.a.5 of Annex IV to Regulation (EC) No 216/2008.
- (b) If icing exceeds the intensity of icing for which the aircraft is certified or if an aircraft not certified for flight in known icing conditions encounters icing, the pilot-in-command shall exit the icing conditions without delay, by a change of level and/or route, and if necessary by declaring an emergency to ATC.

GM1 NCO.OP.170(b) Ice and other contaminants — flight procedures**KNOWN ICING CONDITIONS**

Known icing conditions are conditions where actual ice is observed visually to be on the aircraft by the pilot or identified by on-board sensors.

NCO.OP.175 Take-off conditions — aeroplanes and helicopters

Before commencing take-off, the pilot-in-command shall be satisfied that:

- (a) according to the information available, the weather at the aerodrome or operating site and the condition of the runway or FATO intended to be used would not prevent a safe take-off and departure; and
- (b) applicable aerodrome operating minima will be complied with.

NCO.OP.176 Take-off conditions — balloons

Before commencing take-off, the pilot-in-command of a balloon shall be satisfied that, according to the information available, the weather at the operating site or aerodrome would not prevent a safe take-off and departure.

AMC1 NCO.OP.176 Take-off conditions — balloons**FACILITIES AT THE TAKE-OFF SITE**

At the balloon take-off site a means of assessing the wind direction and wind speed should be available to the pilot-in-command.

NCO.OP.180 Simulated situations in flight

- (a) The pilot-in-command shall, when carrying passengers or cargo, not simulate:
- (1) situations that require the application of abnormal or emergency procedures; or
 - (2) flight in instrument meteorological conditions (IMC).
- (b) Notwithstanding (a), when training flights are conducted by an approved training organisation, such situations may be simulated with student pilots on-board.

NCO.OP.185 In-flight fuel management

The pilot-in-command shall check at regular intervals that the amount of usable fuel or, for balloons, ballast remaining in flight is not less than the fuel or ballast required to proceed to a weather-permissible aerodrome or operating site and the planned reserve fuel as required by NCO.OP.125, NCO.OP.126 or NCO.OP.127.

NCO.OP.190 Use of supplemental oxygen

- (a) The pilot-in-command shall ensure that all flight crew members engaged in performing duties essential to the safe operation of an aircraft in flight use supplemental oxygen continuously whenever he/she determines that at the altitude of the intended flight the lack of oxygen might result in impairment of the faculties of crew members, and shall ensure that supplemental oxygen is available to passengers when lack of oxygen might harmfully affect passengers.
- (b) In any other case when the pilot-in-command cannot determine how the lack of oxygen might affect all occupants on board, he/she shall ensure that:
- (1) all crew members engaged in performing duties essential to the safe operation of an aircraft in flight use supplemental oxygen for any period in excess of 30 minutes when the pressure altitude in the the passenger compartment will be between 10 000 ft and 13 000 ft; and
 - (2) all occupants use supplemental oxygen for any period that the pressure altitude in the the passenger compartment will be above 13 000 ft.

AMC1 NCO.OP.190(a) Use of supplemental oxygen

DETERMINATION OF SUPPLEMENTAL OXYGEN NEED

When determining the need for supplemental oxygen carriage and use, the pilot-in-command should:

- (a) in the preflight phase:
- (1) be aware of hypoxia conditions and associated risks;
 - (2) consider the following objective conditions for the intended flight:
 - (i) altitude;
 - (ii) duration of the flight; and
 - (iii) any other relevant operational conditions.
 - (3) consider individual conditions of flight crew members and passengers in relation to:
 - (i) altitude of the place of residence;
 - (ii) smoking;

- (iii) experience in flights at high altitudes;
 - (iv) actual medical conditions and medications;
 - (v) age
 - (vi) disabilities; and
 - (vii) any other relevant factor that may be detected, or reported by the person; and
- (4) when relevant, ensure that all flight crew members and passengers are briefed on hypoxia conditions and symptoms, as well as on the usage of supplemental oxygen equipment.
- (b) during flight:
- (1) monitor for early symptoms of hypoxia conditions; and
 - (2) if detecting early symptoms of hypoxia conditions:
 - (i) consider to return to a safe altitude, and
 - (ii) ensure that supplemental oxygen is used, if available.

GM1 NCO.OP.190 Use of supplemental oxygen

GENERAL

- (a) The responsibility of the pilot-in-command for safety of all persons on board, as required by NCO.GEN.105(a)(1), includes the determination of need for supplemental oxygen use.
- (b) The altitudes above which NCO.OP.190(b) requires oxygen to be available and used are applicable to those cases when the pilot-in-command cannot determine the need for supplemental oxygen. However, if the pilot-in-command is able to make this determination, he/she may elect in the interest of safety to require oxygen also for operations at or below such altitudes.
- (c) The pilot-in-command should be aware that flying below altitudes mentioned in NCO.OP.190(b) does not provide absolute protection against hypoxia symptoms, should individual conditions and aptitudes be prevalent.

GM2 NCO.OP.190 Use of supplemental oxygen

DETERMINATION OF OXYGEN NEED — BEFORE FLIGHT

Detailed information and guidance on hypoxia conditions and symptoms, content of the briefing on hypoxia and assessment of individual conditions may be found in the EASA leaflet 'Hypoxia'.

DETERMINATION OF OXYGEN NEED — IN FLIGHT

Several methods for monitoring hypoxia early symptoms may be used and some methods may be aided by personal equipment, such as finger-mounted pulse oximeters. Detailed information and guidance on entering hypoxia conditions, on hypoxia symptoms early detection, and on use of personal equipment such as finger-mounted pulse oximeters or equivalent may be found in the EASA leaflet 'Hypoxia'.

NCO.OP.195 Ground proximity detection

When undue proximity to the ground is detected by the pilot-in-command or by a ground proximity warning system, the pilot-in-command shall take corrective action immediately in order to establish safe flight conditions.

NCO.OP.200 Airborne collision avoidance system (ACAS II)

When ACAS II is used, operational procedures and training shall be in accordance with Regulation (EU) No 1332/2011.

NCO.OP.205 Approach and landing conditions — aeroplanes and helicopters

Before commencing an approach to land, the pilot-in-command shall be satisfied that, according to the information available, the weather at the aerodrome or the operating site and the condition of the runway or FATO intended to be used would not prevent a safe approach, landing or missed approach.

AMC1 NCO.OP.205 Approach and landing conditions — aeroplanes and helicopters**LANDING DISTANCE/FATO SUITABILITY**

The in-flight determination of the landing distance/FATO suitability should be based on the latest available meteorological report.

NCO.OP.210 Commencement and continuation of approach — aeroplanes and helicopters

- (a) The pilot-in-command may commence an instrument approach regardless of the reported runway visual range/visibility (RVR/VIS).
- (b) If the reported RVR/VIS is less than the applicable minimum, the approach shall not be continued:
 - (1) below 1 000 ft above the aerodrome; or
 - (2) into the final approach segment in the case where the decision altitude/height (DA/H) or minimum descent altitude/height (MDA/H) is more than 1 000 ft above the aerodrome.
- (c) Where the RVR is not available, RVR values may be derived by converting the reported visibility.
- (d) If, after passing 1 000 ft above the aerodrome, the reported RVR/VIS falls below the applicable minimum, the approach may be continued to DA/H or MDA/H.
- (e) The approach may be continued below DA/H or MDA/H and the landing may be completed provided that the visual reference adequate for the type of approach operation and for the intended runway is established at the DA/H or MDA/H and is maintained.
- (f) The touchdown zone RVR shall always be controlling.

AMC1 NCO.OP.210 Commencement and continuation of approach — aeroplanes and helicopters

VISUAL REFERENCES FOR NPA, APV AND CAT I OPERATIONS

- (a) At DH or MDH, at least one of the visual references specified below should be distinctly visible and identifiable to the pilot:
 - (1) elements of the approach lighting system;
 - (2) the threshold;
 - (3) the threshold markings;
 - (4) the threshold lights;
 - (5) the threshold identification lights;
 - (6) the visual glide slope indicator;
 - (7) the touchdown zone or touchdown zone markings;
 - (8) the touchdown zone lights;
 - (9) FATO/runway edge lights; or
 - (10) other visual references specified in the operations manual.

NCO.OP.215 Operational limitations — hot-air balloons

- (a) A hot-air balloon shall not land during night, except in emergency.
- (b) A hot-air balloon may take off during night, provided sufficient fuel is carried for a landing during day.

GM1 NCO.OP.215 Operational limitations — hot-air balloons**AVOIDANCE OF NIGHT LANDING**

The intent of rule is to ensure that when the balloon takes off during night, sufficient fuel is on board for landing under VFR by day.

The risk of collision with overhead lines is considerable and cannot be overstated. The risk is considerably increased during night flights in conditions of failing light and visibility when there is increasing pressure to land. A number of incidents have occurred in the late evening in just such conditions, and may have been avoided had an earlier landing been planned. Night landings should therefore be avoided by taking appropriate measures, including a larger quantity of fuel and/or additional safety equipment.

NCO.OP.220 Airborne collision avoidance system (ACAS II)

When ACAS II is used, pilot-in-command shall apply the appropriate operational procedures and be adequately trained.

SUBPART C: AIRCRAFT PERFORMANCE AND OPERATING LIMITATIONS

NCO.POL.100 Operating limitations — all aircraft

- (a) During any phase of operation, the loading, the mass and, except for balloons, the centre of gravity (CG) position of the aircraft shall comply with any limitation specified in the AFM, or equivalent document.
- (b) Placards, listings, instrument markings, or combinations thereof, containing those operating limitations prescribed by the AFM for visual presentation, shall be displayed in the aircraft.

NCO.POL.105 Weighing

- (a) The operator shall ensure that the mass and, except for balloons, the CG of the aircraft have been established by actual weighing prior to initial entry into service. The accumulated effects of modifications and repairs on the mass and balance shall be accounted for and properly documented. Such information shall be made available to the pilot-in-command. The aircraft shall be reweighed if the effect of modifications on the mass and balance is not accurately known.
- (b) The weighing shall be accomplished:
 - (1) for aeroplanes and helicopters, by the manufacturer of the aircraft or by an approved maintenance organisation; and
 - (2) for sailplanes and balloons, by the manufacturer of the aircraft or in accordance with Commission Regulation (EC) No 2042/2003, as applicable.

GM1 NCO.POL.105 Weighing

GENERAL

- (a) New aircraft that have been weighed at the factory may be placed into operation without reweighing if the mass records and, except for balloons, balance records have been adjusted for alterations or modifications to the aircraft. Aircraft transferred from one EU operator to another EU operator do not have to be weighed prior to use by the receiving operator, unless the mass and balance cannot be accurately established by calculation.
- (b) For aircraft other than balloons, the mass and centre of gravity (CG) position should be revised whenever the cumulative changes to the dry operating mass exceed ± 0.5 % of the maximum landing mass or, for aeroplanes, the cumulative change in CG position exceeds 0.5 % of the mean aerodynamic chord. This may be done by weighing the aircraft or by calculation. If the AFM requires to record changes to mass and CG position below these thresholds, or to record changes in any case, and make them known to the pilot-in-command, mass and CG position should be revised accordingly and made known to the pilot-in-command.
- (c) The initial empty mass for a balloon is the balloon empty mass determined by a weighing performed by the manufacturer of the balloon before the initial entry into service.
- (d) The mass of a balloon should be revised whenever the cumulative changes to the balloon empty mass due to modifications or repairs exceed ± 10 % of the initial empty mass. This may be done by weighing the balloon or by calculation.

NCO.POL.110 Performance — general

The pilot-in-command shall only operate the aircraft if the performance is adequate to comply with the applicable rules of the air and any other restrictions applicable to the flight, the airspace or the aerodromes or operating sites used, taking into account the charting accuracy of any charts and maps used.

SUBPART D: INSTRUMENTS, DATA AND EQUIPMENT

SECTION 1 Aeroplanes

NCO.IDE.A.100 Instruments and equipment — general

- (a) Instruments and equipment required by this Subpart shall be approved in accordance with the applicable airworthiness requirements if they are:
- (1) used by the flight crew to control the flight path;
 - (2) used to comply with NCO.IDE.A.190;
 - (3) used to comply with NCO.IDE.A.195; or
 - (4) installed in the aeroplane.
- (b) The following items, when required by this Subpart, do not need an equipment approval:
- (1) spare fuses;
 - (2) independent portable lights;
 - (3) an accurate time piece;
 - (4) first-aid kit;
 - (5) survival and signalling equipment;
 - (6) sea anchor and equipment for mooring; and
 - (7) child restraint device.
- (c) Instruments and equipment not required by this Subpart as well as any other equipment that is not required by other applicable Annexes, but is carried on a flight, shall comply with the following:
- (1) the information provided by these instruments or equipment shall not be used by the flight crew to comply with Annex I to Regulation (EC) No 216/2008 or NCO.IDE.A.190 and NCO.IDE.A.195; and
 - (2) the instruments and equipment shall not affect the airworthiness of the aeroplane, even in the case of failures or malfunction.
- (d) Instruments and equipment shall be readily operable or accessible from the station where the flight crew member that needs to use it is seated.
- (e) All required emergency equipment shall be easily accessible for immediate use.

GM1 NCO.IDE.A.100(a) Instruments and equipment — general

APPLICABLE AIRWORTHINESS REQUIREMENTS

The applicable airworthiness requirements for approval of instruments and equipment required by this Part are the following:

- (a) Regulation (EU) No 748/2012⁴ for aeroplanes registered in the EU; and
- (b) Airworthiness requirements of the State of registry for aeroplanes registered outside the EU.

GM1 NCO.IDE.A.100(b) Instruments and equipment — general

REQUIRED INSTRUMENTS AND EQUIPMENT THAT DO NOT NEED TO BE APPROVED IN ACCORDANCE WITH THE APPLICABLE AIRWORTHINESS REQUIREMENTS

The functionality of non-installed instruments and equipment required by this Subpart and that do not need an equipment approval, as listed in NCO.IDE.A.100(b), should be checked against recognised industry standards appropriate to the intended purpose. The operator is responsible for ensuring the maintenance of these instruments and equipment.

GM1 NCO.IDE.A.100(c) Instruments and equipment — general

NOT REQUIRED INSTRUMENTS AND EQUIPMENT THAT DO NOT NEED TO BE APPROVED IN ACCORDANCE WITH THE APPLICABLE AIRWORTHINESS REQUIREMENTS, BUT ARE CARRIED ON A FLIGHT

- (a) The provision of this paragraph does not exempt any installed instrument or item of equipment from complying with the applicable airworthiness requirements. In this case, the installation should be approved as required in the applicable airworthiness requirements and should comply with the applicable Certification Specifications.
- (b) The failure of additional non-installed instruments or equipment not required by this Part or by the applicable airworthiness requirements or any applicable airspace requirements should not adversely affect the airworthiness and/or the safe operation of the aeroplane. Examples may be the following:
 - (1) portable electronic flight bag (EFB);
 - (2) portable electronic devices carried by crew members; and
 - (3) non-installed passenger entertainment equipment.

⁴ Commission Regulation (EU) No 748/2012 of 3 August 2012 laying down implementing rules for the airworthiness and environmental certification of aircraft and related products, parts and appliances, as well as for the certification of design and production organisations, *OJ L 224, 21.8.2012, p. 1*.

NCO.IDE.A.105 Minimum equipment for flight

A flight shall not be commenced when any of the aeroplane instruments, items of equipment or functions required for the intended flight are inoperative or missing, unless:

- (a) the aeroplane is operated in accordance with the MEL, if established; or
- (b) the aeroplane is subject to a permit to fly issued in accordance with the applicable airworthiness requirements.

NCO.IDE.A.110 Spare electrical fuses

Aeroplanes shall be equipped with spare electrical fuses, of the ratings required for complete circuit protection, for replacement of those fuses that are allowed to be replaced in flight.

GM1 NCO.IDE.A.110 Spare electrical fuses**FUSES**

A spare electrical fuse means a replaceable fuse in the flight crew compartment, not an automatic circuit breaker or circuit breakers in the electric compartments.

NCO.IDE.A.115 Operating lights

Aeroplanes operated at night shall be equipped with:

- (a) an anti-collision light system;
- (b) navigation/position lights;
- (c) a landing light;
- (d) lighting supplied from the aeroplane's electrical system to provide adequate illumination for all instruments and equipment essential to the safe operation of the aeroplane;
- (e) lighting supplied from the aeroplane's electrical system to provide illumination in all passenger compartments;
- (f) an independent portable light for each crew member station; and
- (g) lights to conform with the International Regulations for Preventing Collisions at Sea if the aeroplane is operated as a seaplane.

NCO.IDE.A.120 Operations under VFR — flight and navigational instruments and associated equipment

- (a) Aeroplanes operated under VFR by day shall be equipped with a means of measuring and displaying the following:
 - (1) magnetic heading;
 - (2) time, in hours, minutes and seconds;
 - (3) pressure altitude;
 - (4) indicated airspeed; and
 - (5) Mach number, whenever speed limitations are expressed in terms of Mach number.
- (b) Aeroplanes operated under visual meteorological conditions (VMC) at night, or in conditions where the aeroplane cannot be maintained in a desired flight path without reference to one or more additional instruments, shall be, in addition to (a), equipped with:
 - (1) a means of measuring and displaying the following:
 - (i) turn and slip;
 - (ii) attitude;
 - (iii) vertical speed; and
 - (iv) stabilised heading;and
 - (2) a means of indicating when the supply of power to the gyroscopic instruments is not adequate.
- (c) Aeroplanes operated in conditions where they cannot be maintained in a desired flight path without reference to one or more additional instruments, shall be, in addition to (a) and (b), equipped with a means of preventing malfunction of the airspeed indicating system required in (a)(4) due to condensation or icing.

AMC1 NCO.IDE.A.120&NCO.IDE.A.125 Operations under VFR & operations under IFR — flight and navigational instruments and associated equipment

INTEGRATED INSTRUMENTS

- (a) Individual equipment requirements may be met by combinations of instruments, by integrated flight systems or by a combination of parameters on electronic displays. The information so available to each required pilot should not be less than that required in the applicable operational requirements, and the equivalent safety of the installation should be approved during type certification of the aeroplane for the intended type of operation.
- (b) The means of measuring and indicating turn and slip, aeroplane attitude and stabilised aeroplane heading may be met by combinations of instruments or by integrated flight director systems, provided that the safeguards against total failure, inherent in the three separate instruments, are retained.

AMC2 NCO.IDE.A.120 Operations under VFR — flight and navigational instruments and associated equipment

LOCAL FLIGHTS

For flights that do not exceed 60 minutes duration, that take off and land at the same aerodrome, and that remain within 50 NM of that aerodrome, an equivalent means of complying with NCO.IDE.A.120 (b)(1)(i), (b)(1)(ii) may be:

- (a) a turn and slip indicator;
- (b) a turn co-ordinator; or
- (c) both an attitude indicator and a slip indicator.

GM1 NCO.IDE.A.120 Operations under VFR — flight and navigational instruments and associated equipment

SLIP INDICATION

Aeroplanes should be equipped with a means of measuring and displaying slip.

NCO.IDE.A.125 Operations under IFR — flight and navigational instruments and associated equipment

Aeroplanes operated under IFR shall be equipped with:

- (a) a means of measuring and displaying the following:
 - (1) magnetic heading;
 - (2) time in hours, minutes and seconds;
 - (3) pressure altitude;
 - (4) indicated airspeed;
 - (5) vertical speed;
 - (6) turn and slip;
 - (7) attitude;
 - (8) stabilised heading;
 - (9) outside air temperature; and
 - (10) Mach number, whenever speed limitations are expressed in terms of Mach number;
- (b) a means of indicating when the supply of power to the gyroscopic instruments is not adequate; and
- (c) a means of preventing malfunction of the airspeed indicating system required in (a)(4) due to condensation or icing.

GM1 NCO.IDE.A.125 Operations under IFR — flight and navigational instruments and associated equipment

ALTERNATE SOURCE OF STATIC PRESSURE

Aeroplanes should be equipped with an alternate source of static pressure.

AMC1 NCO.IDE.A.120(a)(1)&NCO.IDE.A.125(a)(1) Operations under VFR & operations under IFR — flight and navigational instruments and associated equipment

MEANS OF MEASURING AND DISPLAYING MAGNETIC HEADING

The means of measuring and displaying magnetic direction should be a magnetic compass or equivalent.

AMC1 NCO.IDE.A.120(a)(2)&NCO.IDE.A.125(a)(2) Operations under VFR & operations under IFR — flight and navigational instruments and associated equipment

MEANS OF MEASURING AND DISPLAYING THE TIME

A means of measuring and displaying the time in hours, minutes and seconds may be a wrist watch capable of the same functions.

AMC1 NCO.IDE.A.120(a)(3)&NCO.IDE.A.125(a)(3) Operations under VFR operations & operations under IFR — flight and navigational instruments and associated equipment

CALIBRATION OF THE MEANS OF MEASURING AND DISPLAYING PRESSURE ALTITUDE

The instrument measuring and displaying pressure altitude should be of a sensitive type calibrated in feet (ft), with a sub-scale setting, calibrated in hectopascals/millibars, adjustable for any barometric pressure likely to be set during flight.

GM1 NCO.IDE.A.125(a)(3) Operations under IFR — flight and navigational instruments and associated equipment

ALTIMETERS

Altimeters with counter drum-pointer or equivalent presentation are considered to be less susceptible to misinterpretation for aeroplanes operating above 10 000 ft.

AMC1 NCO.IDE.A.120(a)(4)&NCO.IDE.A.125(a)(4) Operations under VFR & operations under IFR — flight and navigational instruments and associated equipment

CALIBRATION OF THE INSTRUMENT INDICATING AIRSPEED

- (a) The instrument indicating airspeed should be calibrated in knots (kt).
- (b) In the case of aeroplanes with a maximum certified take-off mass (MCTOM) below 2 000 kg, calibration in kilometres per hour (kph) or in miles per hour (mph) is acceptable when such units are used in the AFM.

AMC1 NCO.IDE.A.120(c)&NCO.IDE.A.125(c) Operations under IFR — flight and navigational instruments and associated equipment

MEANS OF PREVENTING MALFUNCTION DUE TO CONDENSATION OR ICING

The means of preventing malfunction due to either condensation or icing of the airspeed indicating system should be a heated pitot tube or equivalent.

AMC1 NCO.IDE.A.125(a)(9) Operations under IFR — flight and navigational instruments and associated equipment

MEANS OF DISPLAYING OUTSIDE AIR TEMPERATURE

- (a) The means of displaying outside air temperature should be calibrated in degrees Celsius.
- (b) In the case of aeroplanes with a maximum certified take-off mass (MCTOM) below 2 000 kg, calibration in degrees Fahrenheit is acceptable, when such unit is used in the AFM.
- (c) The means of displaying outside air temperature may be an air temperature indicator that provides indications that are convertible to outside air temperature.

NCO.IDE.A.130 Terrain awareness warning system (TAWS)

Turbine-powered aeroplanes certified for a maximum passenger seating configuration of more than nine shall be equipped with a TAWS that meets the requirements for:

- (a) class A equipment, as specified in an acceptable standard, in the case of aeroplanes for which the individual certificate of airworthiness (CofA) was first issued after 1 January 2011; or
- (b) class B equipment, as specified in an acceptable standard, in the case of aeroplanes for which the individual CofA was first issued on or before 1 January 2011.

AMC1 NCO.IDE.A.130 Terrain awareness warning system (TAWS)**EXCESSIVE DOWNWARDS GLIDESLOPE DEVIATION WARNING FOR CLASS A TAWS**

The requirement for a Class A TAWS to provide a warning to the flight crew for excessive downwards glideslope deviation should apply to all final approach glideslopes with angular vertical navigation (VNAV) guidance, whether provided by the instrument landing system (ILS), microwave landing system (MLS), satellite-based augmentation system approach procedure with vertical guidance (SBAS APV (localiser performance with vertical guidance approach LPV)), ground-based augmentation system (GBAS (GPS landing system, GLS)) or any other systems providing similar guidance. The same requirement should not apply to systems providing vertical guidance based on barometric VNAV.

GM1 NCO.IDE.A.130 Terrain awareness warning system (TAWS)**ACCEPTABLE STANDARD FOR TAWS**

An acceptable standard for Class A and Class B TAWS may be the applicable European Technical Standards Order (ETSO) issued by the Agency or equivalent.

NCO.IDE.A.135 Flight crew interphone system

Aeroplanes operated by more than one flight crew member shall be equipped with a flight crew interphone system, including headsets and microphones for use by all flight crew members.

AMC1 NCO.IDE.A.135 Flight crew interphone system

GENERAL

- (a) The flight crew interphone system should not be of a handheld type.
- (b) A headset consists of a communication device that includes two earphones to receive and a microphone to transmit audio signals to the aeroplane's communication system. To comply with the minimum performance requirements, the earphones and microphone should match the communication system's characteristics and the flight crew compartment environment. The headset should be adequately adjustable in order to fit the pilot's head. Headset boom microphones should be of the noise cancelling type.
- (c) If the intention is to utilise noise cancelling earphones, the pilot-in-command should ensure that the earphones do not attenuate any aural warnings or sounds necessary for alerting the flight crew on matters related to the safe operation of the aeroplane.

GM1 NCO.IDE.A.135 Flight crew interphone system

HEADSET

The term 'headset' includes any aviation helmet incorporating headphones and microphone worn by a flight crew member.

NCO.IDE.A.140 Seats, seat safety belts, restraint systems and child restraint devices

- (a) Aeroplanes shall be equipped with:
- (1) a seat or berth for each person on board who is aged 24 months or more;
 - (2) a seat belt on each passenger seat and restraining belts for each berth;
 - (3) a child restraint device (CRD) for each person on board younger than 24 months; and
 - (4) a seat belt with upper torso restraint system on each flight crew seat, having a single point release for aeroplanes having a CofA first issued on or after 25 August 2016.

AMC1 NCO.IDE.A.140 Seats, seat safety belts, restraint systems and child restraint devices

CHILD RESTRAINT DEVICES (CRDS)

- (a) A CRD is considered to be acceptable if:
- (1) it is a supplementary loop belt manufactured with the same techniques and the same materials as the approved safety belts; or
 - (2) it complies with (b).
- (b) Provided the CRD can be installed properly on the respective aircraft seat, the following CRDs are considered acceptable:
- (1) CRDs approved for use in aircraft by a competent authority on the basis of a technical standard and marked accordingly.
 - (2) CRDs approved for use in motor vehicles according to the UN standard ECE R 44, -03 or later series of amendments.
 - (3) CRDs approved for use in motor vehicles and aircraft according to Canadian CMVSS 213/213.1.
 - (4) CRDs approved for use in motor vehicles and aircraft according to US FMVSS No 213 and manufactured to these standards on or after February 26, 1985. US approved CRDs manufactured after this date should bear the following labels in red letters:
 - (i) 'THIS CHILD RESTRAINT SYSTEM CONFORMS TO ALL APPLICABLE FEDERAL MOTOR VEHICLE SAFETY STANDARDS'; and
 - (ii) 'THIS RESTRAINT IS CERTIFIED FOR USE IN MOTOR VEHICLES AND AIRCRAFT';
 - (5) CRDs qualified for use in aircraft according to the German 'Qualification Procedure for Child Restraint Systems for Use in Aircraft' (TÜV Doc.: TÜV/958-01/2001); and
 - (6) Devices approved for use in cars, manufactured and tested to standards equivalent to those listed above. The device should be marked with an associated qualification sign, which shows the name of the qualification organisation and a specific identification number, related to the associated qualification project. The qualifying organisation should be a competent and independent organisation that is acceptable to the competent authority.
- (c) Location
- (1) Forward facing CRDs may be installed on both forward and rearward facing passenger seats but only when fitted in the same direction as the passenger seat on which they are positioned. Rearward facing CRDs should only be installed on forward facing passenger seats. A CRD may not be installed within the radius of action of an airbag, unless it is

obvious that the airbag is de-activated or it can be demonstrated that there is no negative impact from the airbag.

- (2) An infant in a CRD should be located as near to a floor level exit as feasible.
 - (3) An infant in a CRD should not hinder evacuation for any passenger.
- (d) Installation
- (1) CRDs should only be installed on a suitable aircraft seat with the type of connecting device they are approved or qualified for. E.g., CRDs to be connected by a three point harness only (most rearward facing baby CRDs currently available) should not be attached to an aeroplane seat with a lap belt only; a CRD designed to be attached to a vehicle seat by means of rigid bar lower anchorages (ISO-FIX or US equivalent) only, should only be used on aeroplane seats that are equipped with such connecting devices and should not be attached by the aeroplane seat lap belt. The method of connecting should be the one shown in the manufacturer's instructions provided with each CRD.
 - (2) All safety and installation instructions should be followed carefully by the responsible adult accompanying the infant.
 - (3) If a forward facing CRD with a rigid backrest is to be fastened by a lap belt, the restraint device should be fastened when the backrest of the passenger seat on which it rests is in a reclined position. Thereafter, the backrest is to be positioned upright. This procedure ensures better tightening of the CRD on the aircraft seat if the aircraft seat is reclinable.
 - (4) The buckle of the adult safety belt should be easily accessible for both opening and closing, and should be in line with the seat belt halves (not canted) after tightening.
 - (5) Forward facing restraint devices with an integral harness must not be installed such that the adult safety belt is secured over the infant.
- (e) Operation
- (1) Each CRD should remain secured to a passenger seat during all phases of flight, unless it is properly stowed when not in use.
 - (2) Where a CRD is adjustable in recline, it should be in an upright position for all occasions when passenger restraint devices are required.

AMC2 NCO.IDE.A.140 Seats, seat safety belts, restraint systems and child restraint devices

UPPER TORSO RESTRAINT SYSTEM

- (a) The following systems are deemed to be compliant with the requirement for an upper torso restraint system:
 - (1) A seat belt with a diagonal shoulder strap;
 - (2) A restraint system having a seat belt and two shoulder straps that may be used independently;
 - (3) A restraint system having a seat belt, two shoulder straps and additional straps that may be used independently.
- (b) The use of the upper torso restraint independently from the use of the seat belt is intended as an option for the comfort of the occupant of the seat in those phases of flight where only the seat belt is required to be fastened. A restraint system including a seat belt and an upper torso restraint that both remain permanently fastened is also acceptable.

SEAT BELT

A seat belt with a diagonal shoulder strap (three anchorage points) is deemed to be compliant with the requirement for a seat belt (two anchorage points).

NCO.IDE.A.145 First-aid kit

- (a) Aeroplanes shall be equipped with a first-aid kit.
- (b) The first-aid kit shall be:
 - (1) readily accessible for use; and
 - (2) kept up-to-date.

AMC1 NCO.IDE.A.145 First-aid kit

CONTENT OF FIRST-AID KITS

- (a) First-aid kits should be equipped with appropriate and sufficient medications and instrumentation. However, these kits should be amended by the operator according to the characteristics of the operation (scope of operation, flight duration, number and demographics of passengers, etc.).
- (b) The following should be included in the FAKs:
 - (1) bandages (assorted sizes),
 - (2) burns dressings (large and small),
 - (3) wound dressings (large and small),
 - (4) adhesive dressings (assorted sizes),
 - (5) antiseptic wound cleaner,
 - (6) safety scissors,
 - (7) disposable gloves.

AMC2 NCO.IDE.A.145 First-aid kit

MAINTENANCE OF FIRST-AID KIT

To be kept up-to-date, the first-aid kit should be:

- (a) inspected periodically to confirm, to the extent possible, that contents are maintained in the condition necessary for their intended use;
- (b) replenished at regular intervals, in accordance with instructions contained on their labels, or as circumstances warrant; and
- (c) replenished after use in-flight at the first opportunity where replacement items are available.

NCO.IDE.A.150 Supplemental oxygen — pressurised aeroplanes

- (a) Pressurised aeroplanes operated at flight altitudes for which the oxygen supply is required in accordance with (b) shall be equipped with oxygen storage and dispensing apparatus capable of storing and dispensing the required oxygen supplies.
- (b) Pressurised aeroplanes operated above flight altitudes at which the pressure altitude in the passenger compartments is above 10 000 ft shall carry enough breathing oxygen to supply:
- (1) all crew members and:
 - (i) 100 % of the passengers for any period when the cabin pressure altitude exceeds 15 000 ft, but in no case less than 10 minutes' supply;
 - (ii) at least 30 % of the passengers, for any period when, in the event of loss of pressurisation and taking into account the circumstances of the flight, the pressure altitude in the passenger compartment will be between 14 000 ft and 15 000 ft; and
 - (iii) at least 10 % of the passengers for any period in excess of 30 minutes when the pressure altitude in the passenger compartment will be between 10 000 ft and 14 000 ft;
 - and
 - (2) all the occupants of the passenger compartment for no less than 10 minutes, in the case of aeroplanes operated at pressure altitudes above 25 000 ft, or operated below that altitude but under conditions that will not allow them to descend safely to a pressure altitude of 13 000 ft within 4 minutes.
- (c) Pressurised aeroplanes operated at flight altitudes above 25 000 ft shall, in addition, be equipped with a device to provide a warning indication to the flight crew of any loss of pressurisation.

AMC1 NCO.IDE.A.150 Supplemental oxygen — pressurised aeroplanes

DETERMINATION OF OXYGEN

- (a) In the determination of the amount of oxygen for the routes to be flown, it is assumed that the aeroplane will descend in accordance with the emergency procedures specified in the AFM, without exceeding its operating limitations, to a flight altitude that will allow the flight to be completed safely (i.e. flight altitudes ensuring adequate terrain clearance, navigational accuracy, hazardous weather avoidance, etc.).
- (b) The amount of oxygen should be determined on the basis of cabin pressure altitude, flight duration, and on the assumption that a cabin pressurisation failure will occur at the pressure altitude or point of flight that is most critical from the standpoint of oxygen need.
- (c) Following a cabin pressurisation failure, the cabin pressure altitude should be considered to be the same as the aeroplane pressure altitude, unless it can be demonstrated to the competent authority that no probable failure of the cabin or pressurisation system will result in a cabin pressure altitude equal to the aeroplane pressure altitude. Under these circumstances, the demonstrated maximum cabin pressure altitude may be used as a basis for determination of oxygen supply.

NCO.IDE.A.155 Supplemental oxygen — non-pressurised aeroplanes

Non-pressurised aeroplanes operated when an oxygen supply is required in accordance with NCO.OP.190 shall be equipped with oxygen storage and dispensing apparatus capable of storing and dispensing the required oxygen supplies.

AMC1 NCO.IDE.A.155 Supplemental oxygen — non-pressurised aeroplanes

DETERMINATION OF OXYGEN

- (a) In the determination of the amount of oxygen for the routes to be flown, it is assumed that the aeroplane will operate at a flight altitude that will allow the flight to be completed safely (i.e. flight altitudes ensuring adequate terrain clearance, navigational accuracy, hazardous weather avoidance, etc.).
- (b) The amount of oxygen should be determined on the basis of cabin pressure altitude and flight duration.

AMC2 NCO.IDE.A.155 Supplemental oxygen supply – non-pressurised aeroplanes

OXYGEN SUPPLY

The need for oxygen supply, when required by NCO.OP.190, may be met either by means of installed equipment or portable equipment.

NCO.IDE.A.160 Hand fire extinguishers

- (a) Aeroplanes, except touring motor gliders (TMG) and ELA1 aeroplanes, shall be equipped with at least one hand fire extinguisher:
- (1) in the flight crew compartment; and
 - (2) in each passenger compartment that is separate from the flight crew compartment, except if the compartment is readily accessible to the flight crew.
- (b) The type and quantity of extinguishing agent for the required fire extinguishers shall be suitable for the type of fire likely to occur in the compartment where the extinguisher is intended to be used and to minimise the hazard of toxic gas concentration in compartments occupied by persons.

NCO.IDE.A.165 Marking of break-in points

If areas of the aeroplane's fuselage suitable for break-in by rescue crews in an emergency are marked, such areas shall be marked as shown in Figure 1.

Figure 1

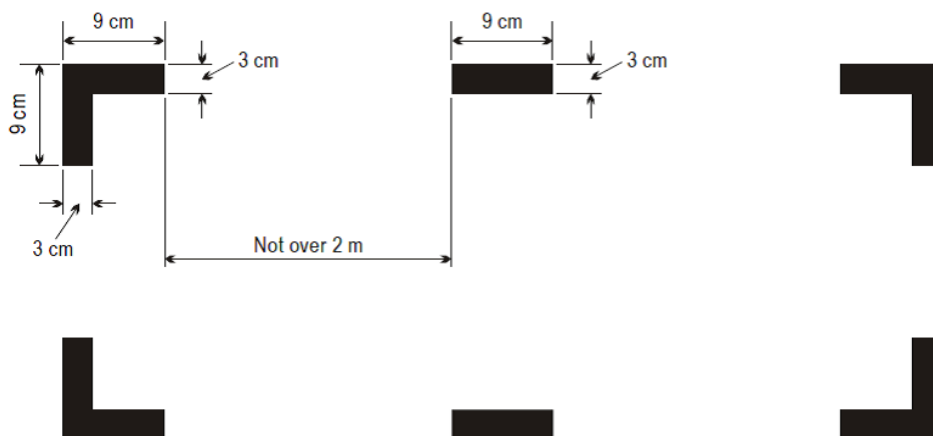
Marking of break-in points**AMC1 NCO.IDE.A.165 Marking of break-in points****MARKINGS — COLOUR AND CORNERS**

- (a) The colour of the markings should be red or yellow and, if necessary, should be outlined in white to contrast with the background.
- (b) If the corner markings are more than 2 m apart, intermediate lines 9 cm x 3 cm should be inserted so that there is no more than 2 m between adjacent markings.

NCO.IDE.A.170 Emergency locator transmitter (ELT)

- (a) Aeroplanes shall be equipped with:
- (1) an ELT of any type, when first issued with an individual CofA on or before 1 July 2008;
 - (2) an automatic ELT, when first issued with an individual CofA after 1 July 2008; or
 - (3) a survival ELT (ELT(S)) or a personal locator beacon (PLB), carried by a crew member or a passenger, when certified for a maximum passenger seating configuration of six or less.
- (b) ELTs of any type and PLBs shall be capable of transmitting simultaneously on 121,5 MHz and 406 MHz.

AMC1 NCO.IDE.A.170 Emergency locator transmitter (ELT)

BATTERIES

- (a) All batteries used in ELTs or PLBs should be replaced (or recharged, if the battery is rechargeable) when the equipment has been in use for more than 1 cumulative hour or in the following cases:
- (1) Batteries specifically designed for use in ELTs and having an airworthiness release certificate (EASA Form 1 or equivalent) should be replaced (or recharged, if the battery is rechargeable) before the end of their useful life in accordance with the maintenance instructions applicable to the ELT.
 - (2) Standard batteries manufactured in accordance with an industry standard and not having an airworthiness release certificate (EASA Form 1 or equivalent), when used in ELTs should be replaced (or recharged, if the battery is rechargeable) when 50 % of their useful life (or for rechargeable, 50 % of their useful life of charge), as established by the battery manufacturer, has expired.
 - (3) All batteries used in PLBs should be replaced (or recharged, if the battery is rechargeable) when 50 % of their useful life (or for rechargeable, 50 % of their useful life of charge), as established by the battery manufacturer, has expired.
 - (4) The battery useful life (or useful life of charge) criteria in (1),(2) and (3) do not apply to batteries (such as water-activated batteries) that are essentially unaffected during probable storage intervals.
- (b) The new expiry date for a replaced (or recharged) battery should be legibly marked on the outside of the equipment.

AMC2 NCO.IDE.A.170 Emergency locator transmitter (ELT)

TYPES OF ELT AND GENERAL TECHNICAL SPECIFICATIONS

- (a) The ELT required by this provision should be one of the following:
- (1) Automatic fixed (ELT(AF)). An automatically activated ELT that is permanently attached to an aircraft and is designed to aid search and rescue (SAR) teams in locating the crash site.
 - (2) Automatic portable (ELT(AP)). An automatically activated ELT that is rigidly attached to an aircraft before a crash, but is readily removable from the aircraft after a crash. It functions as an ELT during the crash sequence. If the ELT does not employ an integral antenna, the aircraft-mounted antenna may be disconnected and an auxiliary antenna (stored on the ELT case) attached to the ELT. The ELT can be tethered to a survivor or a life-raft. This type of ELT is intended to aid SAR teams in locating the crash site or survivor(s).

- (3) Automatic deployable (ELT(AD)). An ELT that is rigidly attached to the aircraft before the crash and that is automatically ejected, deployed and activated by an impact, and, in some cases, also by hydrostatic sensors. Manual deployment is also provided. This type of ELT should float in water and is intended to aid SAR teams in locating the crash site.
 - (4) Survival ELT (ELT(S)). An ELT that is removable from an aircraft, stowed so as to facilitate its ready use in an emergency and manually activated by a survivor. An ELT(S) may be activated manually or automatically (e.g. by water activation). It should be designed either to be tethered to a life-raft or a survivor.
- (b) To minimise the possibility of damage in the event of crash impact, the automatic ELT should be rigidly fixed to the aircraft structure, as far aft as is practicable, with its antenna and connections arranged so as to maximise the probability of the signal being transmitted after a crash.
 - (c) Any ELT carried should operate in accordance with the relevant provisions of ICAO Annex 10, Volume III, and should be registered with the national agency responsible for initiating search and rescue or other nominated agency.

AMC3 NCO.IDE.A.170 Emergency locator transmitter (ELT)

PLB TECHNICAL SPECIFICATIONS

- (a) A personal locator beacon (PLB) should have a built-in GNSS receiver with a cosmicheskaya sistyema poiska avarynich sudov — search and rescue satellite-aided tracking (COSPAS-SARSAT) type approval number. However, devices with a COSPAS-SARSAT number belonging to series 700 are excluded as this series of numbers identifies the special-use beacons not meeting all the technical requirements and all the tests specified by COSPAS-SARSAT.
- (b) Any PLB carried should be registered with the national agency responsible for initiating search and rescue or other nominated agency.

AMC4 NCO.IDE.A.170 Emergency locator transmitter (ELT)

BRIEFING ON PLB USE

When a PLB is carried by a passenger, he/she should be briefed on its characteristics and use by the pilot-in-command before the flight.

GM1 NCO.IDE.A.170 Emergency locator transmitter (ELT)

TERMINOLOGY

- (a) An ELT is a generic term describing equipment that broadcasts distinctive signals on designated frequencies and, depending on application, may be activated by impact or may be manually activated.
- (b) A PLB is an emergency beacon other than an ELT that broadcasts distinctive signals on designated frequencies, is standalone, portable and is manually activated by the survivors.

NCO.IDE.A.175 Flight over water

- (a) The following aeroplanes shall be equipped with a life-jacket for each person on board, or equivalent individual flotation device for each person on board younger than 24 months, that shall be worn or stowed in a position that is readily accessible from the seat or berth of the person for whose use it is provided:
- (1) single-engined landplanes when:
 - (i) flying over water beyond gliding distance from land; or
 - (ii) taking off or landing at an aerodrome or operating site where, in the opinion of the pilot-in-command, the take-off or approach path is so disposed over water that there would be a likelihood of a ditching;
 - (2) seaplanes operated over water; and
 - (3) aeroplanes operated at a distance away from land where an emergency landing is possible greater than that corresponding to 30 minutes at normal cruising speed or 50 NM, whichever is less.
- (b) Seaplanes operated over water shall be equipped with:
- (1) one anchor;
 - (2) one sea anchor (drogue), when necessary to assist in manoeuvring; and
 - (3) equipment for making the sound signals, as prescribed in the International Regulations for Preventing Collisions at Sea, where applicable.
- (c) The pilot-in-command of an aeroplane operated at a distance away from land where an emergency landing is possible greater than that corresponding to 30 minutes at normal cruising speed or 50 NM, whichever is the lesser, shall determine the risks to survival of the occupants of the aeroplane in the event of a ditching, based on which he/she shall determine the carriage of:
- (1) equipment for making the distress signals;
 - (2) life-rafts in sufficient numbers to carry all persons on board, stowed so as to facilitate their ready use in emergency; and
 - (3) life-saving equipment, to provide the means of sustaining life, as appropriate to the flight to be undertaken.

AMC1 NCO.IDE.A.175 Flight over water**ACCESSIBILITY OF LIFE-JACKETS**

The life-jacket, if not worn, should be accessible from the seat or berth of the person for whose use it is provided, with a safety belt or a restraint system fastened.

MEANS OF ILLUMINATION FOR LIFE-JACKETS

Each life-jacket or equivalent individual flotation device should be equipped with a means of electric illumination for the purpose of facilitating the location of persons.

RISK ASSESSMENT

- (a) When conducting the risk assessment, the pilot-in-command should base his/her decision, as far as is practicable, on the Implementing Rules and AMCs applicable to the operation of the aeroplane.
- (b) The pilot-in-command should, for determining the risk, take the following operating environment and conditions into account:
 - (1) sea state;
 - (2) sea and air temperatures;
 - (3) the distance from land suitable for making an emergency landing; and
 - (4) the availability of search and rescue facilities.

GM1 NCO.IDE.A.175 Flight over water**SEAT CUSHIONS**

Seat cushions are not considered to be flotation devices.

NCO.IDE.A.180 Survival equipment

Aeroplanes operated over areas in which search and rescue would be especially difficult shall be equipped with such signalling devices and life-saving equipment, including means of sustaining life, as may be appropriate to the area overflown.

AMC1 NCO.IDE.A.180 Survival equipment

GENERAL

- (a) Aeroplanes operated across land areas in which search and rescue would be especially difficult should be equipped with the following:
 - (1) signalling equipment to make the distress signals;
 - (2) at least one ELT(S) or a PLB, carried by the pilot-in-command or a passenger; and
 - (3) additional survival equipment for the route to be flown, taking account of the number of persons on board.
- (b) The additional survival equipment specified in (a)(3) does not need to be carried when the aeroplane remains within a distance from an area where search and rescue is not especially difficult, that corresponds to:
 - (1) 120 minutes at one-engine-inoperative (OEI) cruising speed for aeroplanes capable of continuing the flight to an aerodrome with the critical engine(s) becoming inoperative at any point along the route or planned diversion routes; or
 - (2) 30 minutes at cruising speed for all other aeroplanes.

AMC2 NCO.IDE.A.180 Survival equipment

ADDITIONAL SURVIVAL EQUIPMENT

- (a) The following additional survival equipment should be carried when required:
 - (1) 500 ml of water for each four, or fraction of four, persons on board;
 - (2) one knife;
 - (3) first-aid equipment; and
 - (4) one set of air/ground codes.
- (b) If any item of equipment contained in the above list is already carried on board the aeroplane in accordance with another requirement, there is no need for this to be duplicated.

GM1 NCO.IDE.A.180 Survival equipment

SIGNALLING EQUIPMENT

The signalling equipment for making distress signals is described in ICAO Annex 2, Rules of the Air.

GM2 NCO.IDE.A.180 Survival equipment

AREAS IN WHICH SEARCH AND RESCUE WOULD BE ESPECIALLY DIFFICULT

The expression 'areas in which search and rescue would be especially difficult' should be interpreted, in this context, as meaning:

-
- (a) areas so designated by the competent authority responsible for managing search and rescue; or
 - (b) areas that are largely uninhabited and where:
 - (1) the authority referred to in (a) has not published any information to confirm whether search and rescue would be or would not be especially difficult; and
 - (2) the authority referred to in (a) does not, as a matter of policy, designate areas as being especially difficult for search and rescue.

NCO.IDE.A.190 Radio communication equipment

- (a) Where required by the airspace being flown aeroplanes shall be equipped with radio communication equipment capable of conducting two-way communication with those aeronautical stations and on those frequencies to meet airspace requirements.
- (b) Radio communication equipment, if required by (a), shall provide for communication on the aeronautical emergency frequency 121,5 MHz.
- (c) When more than one communication equipment unit is required, each shall be independent of the other or others to the extent that a failure in any one will not result in failure of any other.

GM1 NCO.IDE.A.190 Radio communication equipment**APPLICABLE AIRSPACE REQUIREMENTS**

For aeroplanes being operated under European air traffic control, the applicable airspace requirements include the Single European Sky legislation.

NCO.IDE.A.195 Navigation equipment

- (a) Aeroplanes operated over routes that cannot be navigated by reference to visual landmarks shall be equipped with any navigation equipment necessary to enable them to proceed in accordance with:
 - (1) the ATS flight plan; if applicable; and
 - (2) the applicable airspace requirements.
- (b) Aeroplanes shall have sufficient navigation equipment to ensure that, in the event of the failure of one item of equipment at any stage of the flight, the remaining equipment shall allow safe navigation in accordance with (a), or an appropriate contingency action, to be completed safely.
- (c) Aeroplanes operated on flights in which it is intended to land in IMC shall be equipped with suitable equipment capable of providing guidance to a point from which a visual landing can be performed. This equipment shall be capable of providing such guidance for each aerodrome at which it is intended to land in IMC and for any designated alternate aerodromes.
- (d) For PBN operations the aircraft shall meet the airworthiness certification requirements for the appropriate navigation specification.

AMC1 NCO.IDE.A.195 Navigation equipment

NAVIGATION WITH VISUAL REFERENCE TO LANDMARKS

Where aeroplanes, with the surface in sight, can proceed according to the ATS flight plan by navigation with visual reference to landmarks, no additional equipment is needed to comply with NCO.IDE.A.195 (a)(1).

GM1 NCO.IDE.A.195 Navigation equipment

AIRCRAFT ELIGIBILITY FOR PBN SPECIFICATION NOT REQUIRING SPECIFIC APPROVAL

- (a) The performance of the aircraft is usually stated in the AFM/POH.
- (b) Where such a reference cannot be found in the AFM/POH, other information provided by the aircraft manufacturer as TC holder, the STC holder or the design organisation having a privilege to approve minor changes may be considered.
- (c) The following documents are considered acceptable sources of information:
 - (1) AFM/POH, supplements thereto, and documents directly referenced in the AFM/POH;
 - (2) FCOM or similar document;
 - (3) Service Bulletin or Service Letter issued by the TC holder or STC holder;
 - (4) approved design data or data issued in support of a design change approval;
 - (5) any other formal document issued by the TC or STC holders stating compliance with PBN specifications, AMC, Advisory Circulars (AC) or similar documents issued by the State of Design; and
 - (6) written evidence obtained from the State of Design.
- (d) Equipment qualification data, in itself, is not sufficient to assess the PBN capabilities of the aircraft, since the latter depend on installation and integration.
- (e) As some PBN equipment and installations may have been certified prior to the publication of the PBN Manual and the adoption of its terminology for the navigation specifications, it is not

always possible to find a clear statement of aircraft PBN capability in the AFM/POH. However, aircraft eligibility for certain PBN specifications can rely on the aircraft performance certified for PBN procedures and routes prior to the publication of the PBN Manual.

- (f) Below, various references are listed which may be found in the AFM/POH or other acceptable documents (see listing above) in order to consider the aircraft's eligibility for a specific PBN specification if the specific term is not used.
- (g) RNAV 5
- (1) If a statement of compliance with any of the following specifications or standards is found in the acceptable documentation as listed above, the aircraft is eligible for RNAV 5 operations.
- (i) B-RNAV;
 - (ii) RNAV 1;
 - (iii) RNP APCH;
 - (iv) RNP 4;
 - (v) A-RNP;
 - (vi) AMC 20-4;
 - (vii) JAA TEMPORARY GUIDANCE MATERIAL, LEAFLET NO. 2 (TGL 2);
 - (viii) JAA AMJ 20X2;
 - (ix) FAA AC 20-130A for en route operations;
 - (x) FAA AC 20-138 for en route operations; and
 - (xi) FAA AC 90-96.
- (h) RNAV 1/RNAV 2
- (1) If a statement of compliance with any of the following specifications or standards is found in the acceptable documentation as listed above, the aircraft is eligible for RNAV 1/RNAV 2 operations.
- (i) RNAV 1;
 - (ii) PRNAV;
 - (iii) US RNAV type A;
 - (iv) FAA AC 20-138 for the appropriate navigation specification;
 - (v) FAA AC 90-100A;
 - (vi) JAA TEMPORARY GUIDANCE MATERIAL, LEAFLET NO. 10 Rev1 (TGL 10); and
 - (vii) FAA AC 90-100.
- (2) However, if position determination is exclusively computed based on VOR-DME, the aircraft is not eligible for RNAV 1/RNAV 2 operations.
- (i) RNP 1/RNP 2 continental
- (1) If a statement of compliance with any of the following specifications or standards is found in the acceptable documentation as listed above, the aircraft is eligible for RNP 1/RNP 2 continental operations.
- (i) A-RNP;

- (ii) FAA AC 20-138 for the appropriate navigation specification; and
 - (iii) FAA AC 90-105.
 - (2) Alternatively, if a statement of compliance with any of the following specifications or standards is found in the acceptable documentation as listed above and position determination is primarily based on GNSS, the aircraft is eligible for RNP 1/RNP 2 continental operations. However, in these cases, loss of GNSS implies loss of RNP 1/RNP 2 capability.
 - (i) JAA TEMPORARY GUIDANCE MATERIAL, LEAFLET NO. 10 (TGL 10) (any revision); and
 - (ii) FAA AC 90-100.
- (j) RNP APCH — LNAV minima
- (1) If a statement of compliance with any of the following specifications or standards is found in the acceptable documentation as listed above, the aircraft is eligible for RNP APCH — LNAV operations.
 - (i) A-RNP;
 - (ii) AMC 20-27;
 - (iii) AMC 20-28;
 - (iv) FAA AC 20-138 for the appropriate navigation specification; and
 - (v) FAA AC 90-105 for the appropriate navigation specification.
 - (2) Alternatively, if a statement of compliance with RNP 0.3 GNSS approaches in accordance with any of the following specifications or standards is found in the acceptable documentation as listed above, the aircraft is eligible for RNP APCH — LNAV operations. Any limitation such as ‘within the US National Airspace’ may be ignored since RNP APCH procedures are assumed to meet the same ICAO criteria around the world.
 - (i) JAA TEMPORARY GUIDANCE MATERIAL, LEAFLET NO. 3 (TGL 3);
 - (ii) AMC 20-4;
 - (iii) FAA AC 20-130A; and
 - (iv) FAA AC 20-138.
- (k) RNP APCH — LNAV/VNAV minima
- (1) If a statement of compliance with any of the following specifications or standards is found in the acceptable documentation as listed above, the aircraft is eligible for RNP APCH — LNAV/VNAV operations.
 - (i) A-RNP;
 - (ii) AMC 20-27 with Baro VNAV;
 - (iii) AMC 20-28;
 - (iv) FAA AC 20-138; and
 - (v) FAA AC 90-105 for the appropriate navigation specification.
 - (2) Alternatively, if a statement of compliance with FAA AC 20-129 is found in the acceptable documentation as listed above, and the aircraft complies with the requirements and limitations of EASA SIB 2014-04⁵, the aircraft is eligible for RNP APCH — LNAV/VNAV

⁵ <http://ad.easa.europa.eu/ad/2014-04>

operations. Any limitation such as ‘within the US National Airspace’ may be ignored since RNP APCH procedures are assumed to meet the same ICAO criteria around the world.

(l) RNP APCH — LPV minima

- (1) If a statement of compliance with any of the following specifications or standards is found in the acceptable documentation as listed above, the aircraft is eligible for RNP APCH — LPV operations.
 - (i) AMC 20-28;
 - (ii) FAA AC 20-138 for the appropriate navigation specification; and
 - (iii) FAA AC 90-107.
- (2) For aircraft that have a TAWS Class A installed and do not provide Mode-5 protection on an LPV approach, the DH is limited to 250 ft.

(m) RNAV 10

- (1) If a statement of compliance with any of the following specifications or standards is found in the acceptable documentation as listed above, the aircraft is eligible for RNAV 10 operations.
 - (i) RNP 10;
 - (ii) FAA AC 20-138 for the appropriate navigation specification;
 - (iii) AMC 20-12;
 - (iv) FAA Order 8400.12 (or later revision); and
 - (v) FAA AC 90-105.

(n) RNP 4

- (1) If a statement of compliance with any of the following specifications or standards is found in the acceptable documentation as listed above, the aircraft is eligible for RNP 4 operations.
 - (i) FAA AC 20-138B or later, for the appropriate navigation specification;
 - (ii) FAA Order 8400.33; and
 - (iii) FAA AC 90-105 for the appropriate navigation specification.

(o) RNP 2 oceanic

- (1) If a statement of compliance with FAA AC 90-105 for the appropriate navigation specification is found in the acceptable documentation as listed above, the aircraft is eligible for RNP 2 oceanic operations.
- (2) If the aircraft has been assessed eligible for RNP 4, the aircraft is eligible for RNP 2 oceanic.

(p) Special features

- (1) RF in terminal operations (used in RNP 1 and in the initial segment of the RNP APCH)
 - (i) If a statement of demonstrated capability to perform an RF leg, certified in accordance with any of the following specifications or standards, is found in the acceptable documentation as listed above, the aircraft is eligible for RF in terminal operations.
 - (A) AMC 20-26; and

- (B) FAA AC 20-138B or later.
- (ii) If there is a reference to RF and a reference to compliance with AC 90-105, then the aircraft is eligible for such operations.
- (q) Other considerations
 - (1) In all cases, the limitations in the AFM/POH need to be checked, in particular the use of AP or FD which can be required to reduce the FTE primarily for RNP APCH, RNAV 1, and RNP 1.
 - (2) Any limitation such as ‘within the US National Airspace’ may be ignored since RNP APCH procedures are assumed to meet the same ICAO criteria around the world.

GM2 NCO.IDE.A.195 Navigation equipment

GENERAL

- (a) The PBN specifications for which the aircraft complies with the relevant airworthiness criteria are set out in the AFM/POH, together with any limitations to be observed.
- (b) Because functional and performance requirements are defined for each navigation specification, an aircraft approved for an RNP specification is not automatically approved for all RNAV specifications. Similarly, an aircraft approved for an RNP or RNAV specification having a stringent accuracy requirement (e.g. RNP 0.3 specification) is not automatically approved for a navigation specification having a less stringent accuracy requirement (e.g. RNP 4).

RNP 4

- (c) For RNP 4, at least two LRNSs, capable of navigating to RNP 4, and listed in the AFM/POH, may be operational at the entry point of the RNP 4 airspace. If an item of equipment required for RNP 4 operations is unserviceable, then the pilot-in-command may consider an alternate route or diversion for repairs. For multi-sensor systems, the AFM/POH may permit entry if one GNSS sensor is lost after departure, provided one GNSS and one inertial sensor remain available.

NCO.IDE.A.200 Transponder

Where required by the airspace being flown, aeroplanes shall be equipped with a secondary surveillance radar (SSR) transponder with all the required capabilities.

AMC1 NCO.IDE.A.200 Transponder

GENERAL

- (a) The secondary surveillance radar (SSR) transponders of aeroplanes being operated under European air traffic control should comply with any applicable Single European Sky legislation.
- (b) If the Single European Sky legislation is not applicable, the SSR transponders should operate in accordance with the relevant provisions of Volume IV of ICAO Annex 10.

NCO.IDE.A.205 Management of aeronautical databases

Applicable
from 01
January 2019

- (a) Aeronautical databases used on certified aircraft system applications shall meet data quality requirements that are adequate for the intended use of the data.
- (b) The pilot-in-command shall ensure the timely distribution and insertion of current and unaltered aeronautical databases to the aircraft that require them.
- (c) Notwithstanding any other occurrence reporting requirements as defined in Regulation (EU) No 376/2014, the pilot-in-command shall report to the database provider instances of erroneous, inconsistent or missing data that might be reasonably expected to constitute a hazard to flight.

In such cases, the pilot-in-command shall not use the affected data.

SECTION 2
Helicopters**NCO.IDE.H.100 Instruments and equipment — general**

- (a) Instruments and equipment required by this Subpart shall be approved in accordance with the applicable airworthiness requirements if they are:
- (1) used by the flight crew to control the flight path;
 - (2) used to comply with NCO.IDE.H.190;
 - (3) used to comply with NCO.IDE.H.195; or
 - (4) installed in the helicopter.
- (b) The following items, when required by this Subpart, do not need an equipment approval:
- (1) independent portable lights;
 - (2) an accurate time piece;
 - (3) first-aid kit;
 - (4) survival and signalling equipment;
 - (5) sea anchor and equipment for mooring; and
 - (6) child restraint device.
- (c) Instruments and equipment not required by this Subpart, as well as any other equipment that is not required by other applicable Annexes, but is carried on a flight, shall comply with the following:
- (1) the information provided by these instruments or equipment shall not be used by the flight crew to comply with Annex I to Regulation (EC) No 216/2008 or NCO.IDE.H.190 and NCO.IDE.H.195; and
 - (2) the instruments and equipment shall not affect the airworthiness of the helicopter, even in the case of failures or malfunction.
- (d) Instruments and equipment shall be readily operable or accessible from the station where the flight crew member that needs to use it is seated.
- (e) All required emergency equipment shall be easily accessible for immediate use.

GM1 NCO.IDE.H.100(a) Instruments and equipment — general**APPLICABLE AIRWORTHINESS REQUIREMENTS**

The applicable airworthiness requirements for approval of instruments and equipment required by this Part are the following:

- (a) Regulation (EU) No 748/2012 for helicopters registered in the EU; and
- (b) Airworthiness requirements of the State of registry for helicopters registered outside the EU.

GM1 NCO.IDE.H.100(b) Instruments and equipment — general**REQUIRED INSTRUMENTS AND EQUIPMENT THAT DO NOT NEED TO BE APPROVED IN ACCORDANCE WITH THE APPLICABLE AIRWORTHINESS REQUIREMENTS**

The functionality of non-installed instruments and equipment required by this Subpart and that do not need an equipment approval, as listed in NCO.IDE.H.100(b), should be checked against recognised industry standards appropriate to the intended purpose. The operator is responsible for ensuring the maintenance of these instruments and equipment.

GM1 NCO.IDE.H.100(c) Instruments and equipment — general**NOT REQUIRED INSTRUMENTS AND EQUIPMENT THAT DO NOT NEED TO BE APPROVED IN ACCORDANCE WITH THE APPLICABLE AIRWORTHINESS REQUIREMENTS, BUT ARE CARRIED ON A FLIGHT**

- (a) The provision of this paragraph does not exempt any installed instrument or item of equipment from complying with the applicable airworthiness requirements. In this case, the installation should be approved as required in the applicable airworthiness requirements and should comply with the applicable Certification Specifications.
- (b) The failure of additional non-installed instruments or equipment not required by this Part or by the applicable airworthiness requirements or any applicable airspace requirements should not adversely affect the airworthiness and/or the safe operation of the helicopter. Examples may be the following:
 - (1) portable electronic flight bag (EFB);
 - (2) portable electronic devices carried by crew members; and
 - (3) non-installed passenger entertainment equipment.

NCO.IDE.H.105 Minimum equipment for flight

A flight shall not be commenced when any of the helicopter's instruments, items of equipment or functions required for the intended flight are inoperative or missing, unless:

- (a) the helicopter is operated in accordance with the MEL, if established; or
- (b) the helicopter is subject to a permit to fly issued in accordance with the applicable airworthiness requirements.

NCO.IDE.H.115 Operating lights

Helicopters operated at night shall be equipped with:

- (a) an anti-collision light system;
- (b) navigation/position lights;
- (c) a landing light;
- (d) lighting supplied from the helicopter's electrical system to provide adequate illumination for all instruments and equipment essential to the safe operation of the helicopter;
- (e) lighting supplied from the helicopter's electrical system to provide illumination in all passenger compartments;
- (f) an independent portable light for each crew member station; and
- (g) lights to conform with the International Regulations for Preventing Collisions at Sea if the helicopter is amphibious.

AMC1 NCO.IDE.H.115 Operating lights**LANDING LIGHT**

The landing light should be trainable, at least in the vertical plane, or optionally be an additional fixed light or lights positioned to give a wide spread of illumination.

NCO.IDE.H.120 Operations under VFR — flight and navigational instruments and associated equipment

- (a) Helicopters operated under VFR by day shall be equipped with a means of measuring and displaying the following:
- (1) magnetic heading;
 - (2) time in hours, minutes and seconds;
 - (3) pressure altitude;
 - (4) indicated airspeed; and
 - (5) slip.
- (b) Helicopters operated under VMC at night, or when the visibility is less than 1 500 m, or in conditions where the helicopter cannot be maintained in a desired flight path without reference to one or more additional instruments, shall be, in addition to (a), equipped with:
- (1) a means of measuring and displaying the following:
 - (i) attitude;
 - (ii) vertical speed; and
 - (iii) stabilised heading; and
 - (2) a means of indicating when the supply of power to the gyroscopic instruments is not adequate.
- (c) Helicopters operated when the visibility is less than 1 500 m, or in conditions where the helicopter cannot be maintained in a desired flight path without reference to one or more additional instruments, shall be, in addition to (a) and (b), equipped with a means of preventing malfunction of the airspeed indicating system required in (a)(4) due to condensation or icing.

AMC1 NCO.IDE.H.120&NCO.IDE.H.125 Operations under VFR & operations under IFR — flight and navigational instruments and associated equipment

INTEGRATED INSTRUMENTS

- (a) Individual equipment requirements may be met by combinations of instruments, by integrated flight systems or by a combination of parameters on electronic displays. The information so available to each required pilot should not be less than that required in the applicable operational requirements, and the equivalent safety of the installation should be approved during type certification of the helicopter for the intended type of operation.
- (b) The means of measuring and indicating turn and slip, helicopter attitude and stabilised helicopter heading may be met by combinations of instruments or by integrated flight director systems, provided that the safeguards against total failure, inherent in the three separate instruments, are retained.

AMC1 NCO.IDE.H.120(a)(1)&NCO.IDE.H.125(a)(1) Operations under VFR & operations under IFR — flight and navigational instruments and associated equipment

MEANS OF MEASURING AND DISPLAYING MAGNETIC HEADING

The means of measuring and displaying magnetic direction should be a magnetic compass or equivalent.

AMC1 NCO.IDE.H.120(a)(2)&NCO.IDE.H.125(a)(2) Operations under VFR & operations under IFR — flight and navigational instruments and associated equipment

MEANS OF MEASURING AND DISPLAYING THE TIME

A means of measuring and displaying the time in hours, minutes and seconds may be a wrist watch capable of the same functions.

AMC1 NCO.IDE.H.120(a)(3)&NCO.IDE.H.125(a)(3) Operations under VFR & operations under IFR — flight and navigational instruments and associated equipment

CALIBRATION OF THE MEANS OF MEASURING AND DISPLAYING PRESSURE ALTITUDE

The instrument measuring and displaying pressure altitude should be of a sensitive type calibrated in feet (ft), with a sub-scale setting, calibrated in hectopascals/millibars, adjustable for any barometric pressure likely to be set during flight.

AMC1 NCO.IDE.H.120(a)(5) Operations under VFR — flight and navigational instruments and associated equipment

SLIP

The means of measuring and displaying slip may be a slip string for operations under VFR.

NCO.IDE.H.125 Operations under IFR — flight and navigational instruments and associated equipment

Helicopters operated under IFR shall be equipped with:

- (a) a means of measuring and displaying the following:
 - (1) magnetic heading;
 - (2) time in hours, minutes and seconds;
 - (3) pressure altitude;
 - (4) indicated airspeed;
 - (5) vertical speed;
 - (6) slip;
 - (7) attitude;
 - (8) stabilised heading; and
 - (9) outside air temperature;
- (b) a means of indicating when the supply of power to the gyroscopic instruments is not adequate;
- (c) a means of preventing malfunction of the airspeed indicating system required by (a)(4) due to condensation or icing; and
- (d) an additional means of measuring and displaying attitude as a standby instrument.

GM1 NCO.IDE.H.125(a)(3) Operations under IFR — flight and navigational instruments and associated equipment

ALTIMETERS

Altimeters with counter drum-pointer or equivalent presentation are considered to be less susceptible to misinterpretation for helicopters operating above 10 000 ft.

AMC1 NCO.IDE.H.120(a)(4)&NCO.IDE.H.125(a)(4) Operations under VFR & operations under IFR — flight and navigational instruments and associated equipment

CALIBRATION OF THE INSTRUMENT INDICATING AIRSPEED

- (a) The instrument indicating airspeed should be calibrated in knots (kt).
- (b) In the case of helicopters with an MCTOM below 2 000 kg, calibration in kilometres per hour (kph) or in miles per hour (mph) is acceptable when such units are used in the AFM.

AMC1 NCO.IDE.H.120(b)(1)(iii)&NCO.IDE.H.125(a)(8) Operations under VFR & operations under IFR — flight and navigational instruments and associated equipment

STABILISED HEADING

Stabilised direction should be achieved for VFR flights by a gyroscopic direction indicator, whereas for IFR flights, this should be achieved through a magnetic gyroscopic direction indicator.

AMC1 NCO.IDE.H.120(c)&NCO.IDE.H.125(c) Operations under VFR & Operations under IFR — flight and navigational instruments and associated equipment

MEANS OF PREVENTING MALFUNCTION DUE TO CONDENSATION OR ICING

The means of preventing malfunction due to either condensation or icing of the airspeed indicating system should be a heated pitot tube or equivalent.

AMC1 NCO.IDE.H.125(a)(9) Operations under IFR — flight and navigational instruments and associated equipment

MEANS OF DISPLAYING OUTSIDE AIR TEMPERATURE

- (a) The means of displaying outside air temperature should be calibrated in degrees Celsius.
- (b) In the case of helicopters with a maximum certified take-off mass (MCTOM) below 2 000 kg, calibration in degrees Fahrenheit is acceptable, when such unit is used in the AFM.
- (c) The means of displaying outside air temperature may be an air temperature indicator that provides indications that are convertible to outside air temperature.

NCO.IDE.H.126 Additional equipment for single pilot operations under IFR

Helicopters operated under IFR with a single pilot shall be equipped with an autopilot with at least altitude hold and heading mode.

NCO.IDE.H.135 Flight crew interphone system

Helicopters operated by more than one flight crew member shall be equipped with a flight crew interphone system, including headsets and microphones for use by all flight crew members.

AMC1 NCO.IDE.H.135 Flight crew interphone system

GENERAL

- (a) The flight crew interphone system should not be of a handheld type.
- (b) A headset consists of a communication device which includes two earphones to receive and a microphone to transmit audio signals to the helicopter's communication system. To comply with the minimum performance requirements, the earphones and microphone should match the communication system's characteristics and the flight crew compartment environment. The headset should be adequately adjustable in order to fit the pilot's head. Headset boom microphones should be of the noise cancelling type.
- (c) If the intention is to utilise noise cancelling earphones, the pilot-in-command should ensure that the earphones do not attenuate any aural warnings or sounds necessary for alerting the flight crew on matters related to the safe operation of the helicopter.

GM1 NCO.IDE.H.135 Flight crew interphone system

HEADSET

The term 'headset' includes any aviation helmet incorporating headphones and microphone worn by a flight crew member.

NCO.IDE.H.140 Seats, seat safety belts, restraint systems and child restraint devices

- (a) Helicopters shall be equipped with:
- (1) a seat or berth for each person on board who is aged 24 months or more;
 - (2) a seat belt on each passenger seat and restraining belts for each berth;
 - (3) for helicopters first issued with an individual CofA after 31 December 2012, a seat belt with an upper torso restraint system for each passenger who is aged 24 months or more;
 - (4) a child restraint device for each person on board younger than 24 months; and
 - (5) a seat belt with upper torso restraint system incorporating a device that will automatically restrain the occupant's torso in the event of rapid deceleration on each flight crew seat.
- (b) A seat belt with upper torso restraint system shall have a single point release.

AMC1 NCO.IDE.H.140 Seats, seat safety belts, restraint systems and child restraint devices

CHILD RESTRAINT DEVICES (CRDS)

- (a) A CRD is considered to be acceptable if:
- (1) it is a supplementary loop belt manufactured with the same techniques and the same materials of the approved safety belts; or
 - (2) it complies with (b).
- (b) Provided the CRD can be installed properly on the respective helicopter seat, the following CRDs are considered acceptable:
- (1) CRDs approved for use in aircraft by a competent authority on the basis of a technical standard and marked accordingly.
 - (2) CRDs approved for use in motor vehicles according to the UN standard ECE R 44, -03 or later series of amendments.
 - (3) CRDs approved for use in motor vehicles and aircraft according to Canadian CMVSS 213/213.1.
 - (4) CRDs approved for use in motor vehicles and aircraft according to US FMVSS No 213 and manufactured to these standards on or after February 26, 1985. US approved CRDs manufactured after this date should bear the following labels in red letters:
 - (i) 'THIS CHILD RESTRAINT SYSTEM CONFORMS TO ALL APPLICABLE FEDERAL MOTOR VEHICLE SAFETY STANDARDS'; and
 - (ii) 'THIS RESTRAINT IS CERTIFIED FOR USE IN MOTOR VEHICLES AND AIRCRAFT';
 - (5) CRDs qualified for use in aircraft according to the German 'Qualification Procedure for Child Restraint Systems for Use in Aircraft' (TÜV Doc.: TÜV/958-01/2001); and
 - (6) Devices approved for use in cars, manufactured and tested to standards equivalent to those listed above. The device should be marked with an associated qualification sign, which shows the name of the qualification organisation and a specific identification number, related to the associated qualification project. The qualifying organisation should be a competent and independent organisation that is acceptable to the competent authority.

(c) Location

- (1) Forward facing CRDs may be installed on both forward and rearward facing passenger seats but only when fitted in the same direction as the passenger seat on which they are positioned. Rearward facing CRDs should only be installed on forward facing passenger seats. A CRD may not be installed within the radius of action of an airbag, unless it is obvious that the airbag is de-activated or it can be demonstrated that there is no negative impact from the airbag.
- (2) An infant in a CRD should be located as near to a floor level exit as feasible.
- (3) An infant in a CRD should not hinder evacuation for any passenger.

(d) Installation

- (1) CRDs should only be installed on a suitable helicopter seat with the type of connecting device they are approved or qualified for. E.g., CRDs to be connected by a three point harness only (most rearward facing baby CRDs currently available) should not be attached to a helicopter seat with a lap belt only; a CRD designed to be attached to a vehicle seat by means of rigid bar lower anchorages (ISO-FIX or US equivalent) only, should only be used on helicopter seats that are equipped with such connecting devices and should not be attached by the helicopter seat lap belt. The method of connecting should be the one shown in the manufacturer's instructions provided with each CRD.
- (2) All safety and installation instructions should be followed carefully by the responsible person accompanying the infant.
- (3) If a forward facing CRD with a rigid backrest is to be fastened by a lap belt, the restraint device should be fastened when the backrest of the passenger seat on which it rests is in a reclined position. Thereafter, the backrest is to be positioned upright. This procedure ensures better tightening of the CRD on the aircraft seat if the aircraft seat is reclinable.
- (4) The buckle of the adult safety belt should be easily accessible for both opening and closing, and should be in line with the seat belt halves (not canted) after tightening.
- (5) Forward facing restraint devices with an integral harness must not be installed such that the adult safety belt is secured over the infant.

(e) Operation

- (1) Each CRD should remain secured to a passenger seat during all phases of flight, unless it is properly stowed when not in use.
- (2) Where a CRD is adjustable in recline, it should be in an upright position for all occasions when passenger restraint devices are required.

AMC2 NCO.IDE.H.140 Seats, seat safety belts, restraint systems and child restraint devices

UPPER TORSO RESTRAINT SYSTEM

The following systems are deemed to be compliant with the requirement for an upper torso restraint system:

- (a) a seat belt with a diagonal shoulder strap;
- (b) a restraint system having a seat belt and two shoulder straps that may be used independently;
- (c) a restraint system having a seat belt, two shoulder straps and additional straps that may be used independently.

SEAT BELT

A seat belt with diagonal shoulder strap (three anchorage points) is deemed to be compliant with the requirement for a seat belt (two anchorage points).

NCO.IDE.H.145 First-aid kit

- (a) Helicopters shall be equipped with a first-aid kit.
- (b) The first-aid kit shall be:
 - (1) readily accessible for use; and
 - (2) kept up-to-date.

AMC1 NCO.IDE.H.145 First-aid kit

CONTENT OF FIRST-AID KITS

- (a) First-aid kits should be equipped with appropriate and sufficient medications and instrumentation. However, these kits should be amended by the operator according to the characteristics of the operation (scope of operation, flight duration, number and demographics of passengers, etc.).
- (b) The following should be included in the FAKs:
 - (1) bandages (assorted sizes),
 - (2) burns dressings (large and small),
 - (3) wound dressings (large and small),
 - (4) adhesive dressings (assorted sizes),
 - (5) antiseptic wound cleaner,
 - (6) safety scissors,
 - (7) disposable gloves.

AMC2 NCO.IDE.H.145 First-aid kit

MAINTENANCE OF FIRST-AID KIT

To be kept up-to-date, the first-aid kit should be:

- (a) inspected periodically to confirm, to the extent possible, that contents are maintained in the condition necessary for their intended use;
- (b) replenished at regular intervals, in accordance with instructions contained on their labels, or as circumstances warrant; and
- (c) replenished after use in-flight at the first opportunity where replacement items are available.

NCO.IDE.H.155 Supplemental oxygen — non-pressurised helicopters

Non-pressurised helicopters operated when an oxygen supply is required in accordance with NCO.OP.190 shall be equipped with oxygen storage and dispensing apparatus capable of storing and dispensing the required oxygen supplies.

AMC1 NCO.IDE.H.155 Supplemental oxygen — non-pressurised helicopters

DETERMINATION OF OXYGEN

The amount of oxygen should be determined on the basis of cabin pressure altitude and flight duration, consistent with the operating procedures, including emergency procedures, established for each operation and the routes to be flown as specified in the AFM.

AMC2 NCO.IDE.H.155 Supplemental oxygen supply – non-pressurised helicopters

OXYGEN SUPPLY

The need for oxygen supply, when required by NCO.OP.190, may be met either by means of installed equipment or portable equipment.

NCO.IDE.H.160 Hand fire extinguishers

- (a) Helicopters, except ELA2 helicopters, shall be equipped with at least one hand fire extinguisher:
- (1) in the flight crew compartment; and
 - (2) in each passenger compartment that is separate from the flight crew compartment, except if the compartment is readily accessible to the flight crew.
- (b) The type and quantity of extinguishing agent for the required fire extinguishers shall be suitable for the type of fire likely to occur in the compartment where the extinguisher is intended to be used and to minimise the hazard of toxic gas concentration in compartments occupied by persons.

NCO.IDE.H.165 Marking of break-in points

If areas of the helicopter's fuselage suitable for break-in by rescue crews in an emergency are marked, such areas shall be marked as shown in Figure 1.

Figure 1

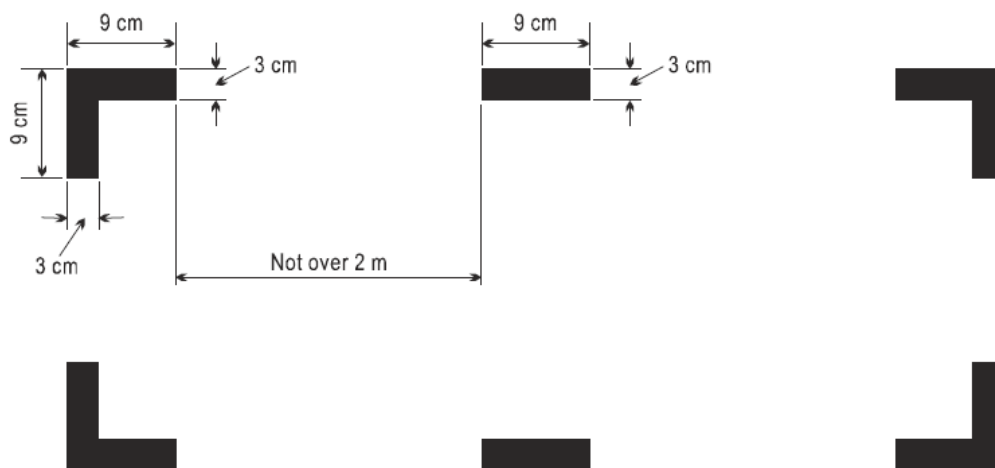
Marking of break-in points**AMC1 NCO.IDE.H.165 Marking of break-in points****MARKINGS — COLOUR AND CORNERS**

- (a) The colour of the markings should be red or yellow and, if necessary, should be outlined in white to contrast with the background.
- (b) If the corner markings are more than 2 m apart, intermediate lines 9 cm x 3 cm should be inserted so that there is no more than 2 m between adjacent markings.

NCO.IDE.H.170 Emergency locator transmitter (ELT)

- (a) Helicopters certified for a maximum passenger seating configuration above six shall be equipped with:
 - (1) an automatic ELT; and
 - (2) one survival ELT (ELT(S)) in a life-raft or life-jacket when the helicopter is operated at a distance from land corresponding to more than 3 minutes flying time at normal cruising speed.
- (b) Helicopters certified for a maximum passenger seating configuration of six or less shall be equipped with an ELT(S) or a personal locator beacon (PLB), carried by a crew member or a passenger.
- (c) ELTs of any type and PLBs shall be capable of transmitting simultaneously on 121,5 MHz and 406 MHz.

AMC1 NCO.IDE.H.170 Emergency locator transmitter (ELT)

BATTERIES

- (a) All batteries used in ELTs or PLBs should be replaced (or recharged, if the battery is rechargeable) when the equipment has been in use for more than 1 cumulative hour or in the following cases:
 - (1) Batteries specifically designed for use in ELTs and having an airworthiness release certificate (EASA Form 1 or equivalent) should be replaced (or recharged, if the battery is rechargeable) before the end of their useful life in accordance with the maintenance instructions applicable to the ELT.
 - (2) Standard batteries manufactured in accordance with an industry standard and not having an airworthiness release certificate (EASA Form 1 or equivalent), when used in ELTs should be replaced (or recharged, if the battery is rechargeable) when 50 % of their useful life (or for rechargeable, 50 % of their useful life of charge), as established by the battery manufacturer, has expired.
 - (3) All batteries used in PLBs should be replaced (or recharged, if the battery is rechargeable) when 50 % of their useful life (or for rechargeable, 50 % of their useful life of charge), as established by the battery manufacturer, has expired.
 - (4) The battery useful life (or useful life of charge) criteria in (1),(2) and (3) do not apply to batteries (such as water-activated batteries) that are essentially unaffected during probable storage intervals.
- (b) The new expiry date for a replaced (or recharged) battery should be legibly marked on the outside of the equipment.

AMC2 NCO.IDE.H.170 Emergency locator transmitter (ELT)

TYPES OF ELT AND GENERAL TECHNICAL SPECIFICATIONS

- (a) The ELT required by this provision should be one of the following:
 - (1) Automatic fixed (ELT(AF)). An automatically activated ELT that is permanently attached to an aircraft and is designed to aid SAR teams in locating the crash site.
 - (2) Automatic portable (ELT(AP)). An automatically activated ELT that is rigidly attached to an aircraft before a crash, but is readily removable from the aircraft after a crash. It functions

as an ELT during the crash sequence. If the ELT does not employ an integral antenna, the aircraft-mounted antenna may be disconnected and an auxiliary antenna (stored on the ELT case) attached to the ELT. The ELT can be tethered to a survivor or a life-raft. This type of ELT is intended to aid SAR teams in locating the crash site or survivor(s).

- (3) Automatic deployable (ELT(AD)). An ELT that is rigidly attached to the aircraft before the crash and that is automatically ejected, deployed and activated by an impact, and, in some cases, also by hydrostatic sensors. Manual deployment is also provided. This type of ELT should float in water and is intended to aid SAR teams in locating the crash site.
 - (4) Survival ELT (ELT(S)). An ELT that is removable from an aircraft, stowed so as to facilitate its ready use in an emergency, and manually activated by a survivor. An ELT(S) may be activated manually or automatically (e.g. by water activation). It should be designed either to be tethered to a life-raft or a survivor.
- (b) To minimise the possibility of damage in the event of crash impact, the automatic ELT should be rigidly fixed to the aircraft structure, as far aft as is practicable, with its antenna and connections arranged so as to maximise the probability of the signal being transmitted after a crash.
 - (c) Any ELT carried should operate in accordance with the relevant provisions of ICAO Annex 10, Volume III, and should be registered with the national agency responsible for initiating search and rescue or other nominated agency.

AMC3 NCO.IDE.H.170 Emergency locator transmitter (ELT)

PLB TECHNICAL SPECIFICATIONS

- (a) A personal locator beacon (PLB) should have a built-in GNSS receiver with a *cosmicheskaya sistyema poiska avariynich sudov* — search and rescue satellite-aided tracking (COSPAS-SARSAT) type approval number. However, devices with a COSPAS-SARSAT number belonging to series 700 are excluded as this series of numbers identifies the special-use beacons not meeting all the technical requirements and all the tests specified by COSPAS-SARSAT.
- (b) Any PLB carried should be registered with the national agency responsible for initiating search and rescue or other nominated agency.

AMC4 NCO.IDE.H.170 Emergency locator transmitter (ELT)

BRIEFING ON PLB USE

When a PLB is carried by a passenger, he/she should be briefed on its characteristics and use by the pilot-in-command before the flight.

GM1 NCO.IDE.H.170 Emergency locator transmitter (ELT)

TERMINOLOGY

- (a) An ELT is a generic term describing equipment that broadcasts distinctive signals on designated frequencies and, depending on application, may be activated by impact or may be manually activated.
- (b) A PLB is an emergency beacon other than an ELT that broadcasts distinctive signals on designated frequencies, is standalone, portable and is manually activated by the survivors.

NCO.IDE.H.175 Flight over water

- (a) Helicopters shall be equipped with a life-jacket for each person on board or equivalent individual flotation device for each person on board younger than 24 months, which shall be worn or stowed in a position that is readily accessible from the seat or berth of the person for whose use it is provided, when:
- (1) flying over water beyond autorotational distance from land where in case of the critical engine failure, the helicopter is not able to sustain level flight; or
 - (2) flying over water at a distance of land corresponding to more than 10 minutes flying at normal cruising speed, where in case of the critical engine failure, the helicopter is able to sustain level flight; or
 - (3) taking off or landing at an aerodrome/operating site where the take-off or approach path is over water.
- (b) Each life-jacket or equivalent individual flotation device shall be equipped with a means of electric illumination for the purpose of facilitating the location of persons.
- (c) The pilot-in-command of a helicopter operated on a flight over water at a distance from land corresponding to more than 30 minutes flying time at normal cruising speed or 50 NM, whichever is less, shall determine the risks to survival of the occupants of the helicopter in the event of a ditching, based on which he/she shall determine the carriage of:
- (1) equipment for making the distress signals;
 - (2) life-rafts in sufficient numbers to carry all persons on board, stowed so as to facilitate their ready use in emergency; and
 - (3) life-saving equipment, to provide the means of sustaining life, as appropriate to the flight to be undertaken.
- (d) The pilot-in-command shall determine the risks to survival of the occupants of the helicopter in the event of a ditching, when deciding if the life-jackets required in (a) shall be worn by all occupants.

AMC1 NCO.IDE.H.175 Flight over water**ACCESSIBILITY OF LIFE-JACKETS**

The life-jacket, if not worn, should be accessible from the seat or berth of the person for whose use it is provided, with a safety belt or a restraint system fastened.

RISK ASSESSMENT

- (a) When conducting the risk assessment, the pilot-in-command should base his/her decision, as far as is practicable, on the Implementing Rules and AMCs applicable to the operation of the helicopter.
- (b) The pilot-in-command should, for determining the risk, take the following operating environment and conditions into account:
- (1) sea state;
 - (2) sea and air temperatures;
 - (3) the distance from land suitable for making an emergency landing; and
 - (4) the availability of search and rescue facilities.

GM1 NCO.IDE.H.175 Flight over water

SEAT CUSHIONS

Seat cushions are not considered to be flotation devices.

NCO.IDE.H.180 Survival equipment

Helicopters, operated over areas in which search and rescue would be especially difficult, shall be equipped with such signalling devices and life-saving equipment, including means of sustaining life, as may be appropriate to the area overflown.

AMC1 NCO.IDE.H.180 Survival equipment

GENERAL

Helicopters operated across areas in which search and rescue would be especially difficult should be equipped with the following:

- (a) signalling equipment to make the distress signals;
- (b) at least one ELT(S) or a PLB, carried by the pilot-in-command or a passenger; and
- (c) additional survival equipment for the route to be flown taking account of the number of persons on board.

AMC2 NCO.IDE.H.180 Survival equipment

ADDITIONAL SURVIVAL EQUIPMENT

- (a) The following additional survival equipment should be carried when required:
 - (1) 500 ml of water for each four, or fraction of four, persons on board;
 - (2) one knife;
 - (3) first-aid equipment; and
 - (4) one set of air/ground codes.
- (b) If any item of equipment contained in the above list is already carried on board the helicopter in accordance with another requirement, there is no need for this to be duplicated.

GM1 NCO.IDE.H.180 Survival equipment

SIGNALLING EQUIPMENT

The signalling equipment for making distress signals is described in ICAO Annex 2, Rules of the Air.

GM2 NCO.IDE.H.180 Survival equipment

AREAS IN WHICH SEARCH AND RESCUE WOULD BE ESPECIALLY DIFFICULT

The expression 'areas in which search and rescue would be especially difficult' should be interpreted, in this context, as meaning:

- (a) areas so designated by the competent authority responsible for managing search and rescue; or
- (b) areas that are largely uninhabited and where:
 - (1) the authority referred to in (a) has not published any information to confirm whether search and rescue would be or would not be especially difficult; and
 - (2) the authority referred to in (a) does not, as a matter of policy, designate areas as being especially difficult for search and rescue.

NCO.IDE.H.185 All helicopters on flights over water — ditching

Helicopters flying over water in a hostile environment beyond a distance of 50 NM from land shall be:

- (a) designed for landing on water in accordance with the relevant airworthiness code;
- (b) certified for ditching in accordance with the relevant airworthiness code; or
- (c) fitted with emergency flotation equipment.

AMC1 NCO.IDE.H.185 All helicopters on flights over water — ditching**EMERGENCY FLOTATION EQUIPMENT**

The same considerations of AMC1 NCC.IDE.H.231 should apply in respect of emergency flotation equipment.

The considerations of AMC1 SPA.HOFO.165(d) should apply in respect of emergency flotation equipment.

Grey text is applicable until 01 July 2018, then is replaced by the paragraph below it.

NCO.IDE.H.190 Radio communication equipment

- (a) Where required by the airspace being flown helicopters shall be equipped with radio communication equipment capable of conducting two-way communication with those aeronautical stations and on those frequencies to meet airspace requirements.
- (b) Radio communication equipment, if required by (a), shall provide for communication on the aeronautical emergency frequency 121,5 MHz.
- (c) When more than one communications equipment unit is required, each shall be independent of the other or others to the extent that a failure in any one will not result in failure of any other.
- (d) When a radio communication system is required, and in addition to the flight crew interphone system required in NCO.IDE.H.135, helicopters shall be equipped with a transmit button on the flight controls for each required pilot and/or crew member at his/her working station.

NCO.IDE.H.195 Navigation equipment

- (a) Helicopters operated over routes that cannot be navigated by reference to visual landmarks shall be equipped with navigation equipment that will enable them to proceed in accordance with:
 - (1) the ATS flight plan, if applicable; and
 - (2) the applicable airspace requirements.
- (b) Helicopters shall have sufficient navigation equipment to ensure that, in the event of the failure of one item of equipment at any stage of the flight, the remaining equipment shall allow safe navigation in accordance with (a), or an appropriate contingency action, to be completed safely.
- (c) Helicopters operated on flights in which it is intended to land in IMC shall be equipped with navigation equipment capable of providing guidance to a point from which a visual landing can be performed. This equipment shall be capable of providing such guidance for each aerodrome at which is intended to land in IMC and for any designated alternate aerodromes.
- (d) For PBN operations the aircraft shall meet the airworthiness certification requirements for the appropriate navigation specification.

AMC1 NCO.IDE.H.195 Navigation equipment

NAVIGATION WITH VISUAL REFERENCE TO LANDMARKS

Where helicopters, with the surface in sight, can proceed according to the ATS flight plan by navigation with visual reference to landmarks, no additional equipment is needed to comply NCO.IDE.H.195(a)(1).

GM1 NCO.IDE.H.195 Navigation equipment

APPLICABLE AIRSPACE REQUIREMENTS

For helicopters being operated under European air traffic control, the applicable airspace requirements include the Single European Sky legislation.

GM2 NCO.IDE.H.195 Navigation equipment

AIRCRAFT ELIGIBILITY FOR PBN SPECIFICATION NOT REQUIRING SPECIFIC APPROVAL

- (a) The performance of the aircraft is usually stated in the AFM/POH.

-
- (b) Where such a reference cannot be found in the AFM/POH, other information provided by the aircraft manufacturer as TC holder, the STC holder or the design organisation having a privilege to approve minor changes may be considered.
- (c) The following documents are considered acceptable sources of information:
- (1) AFM/POH, supplements thereto, and documents directly referenced in the AFM/POH;
 - (2) FCOM or similar document;
 - (3) Service Bulletin or Service Letter issued by the TC holder or STC holder;
 - (4) approved design data or data issued in support of a design change approval;
 - (5) any other formal document issued by the TC or STC holders stating compliance with PBN specifications, AMC, Advisory Circulars (AC) or similar documents issued by the State of Design; and
 - (6) written evidence obtained from the State of Design.
- (d) Equipment qualification data, in itself, is not sufficient to assess the PBN capabilities of the aircraft, since the latter depend on installation and integration.
- (e) As some PBN equipment and installations may have been certified prior to the publication of the PBN Manual and the adoption of its terminology for the navigation specifications, it is not always possible to find a clear statement of aircraft PBN capability in the AFM/POH. However, aircraft eligibility for certain PBN specifications can rely on the aircraft performance certified for PBN procedures and routes prior to the publication of the PBN Manual.
- (f) Below, various references are listed which may be found in the AFM/POH or other acceptable documents (see listing above) in order to consider the aircraft's eligibility for a specific PBN specification if the specific term is not used.
- (g) RNAV 5
- (1) If a statement of compliance with any of the following specifications or standards is found in the acceptable documentation as listed above, the aircraft is eligible for RNAV 5 operations.
 - (i) B-RNAV;
 - (ii) RNAV 1;
 - (iii) RNP APCH;
 - (iv) RNP 4;
 - (v) A-RNP;
 - (vi) AMC 20-4;
 - (vii) JAA TEMPORARY GUIDANCE MATERIAL, LEAFLET NO. 2 (TGL 2)
 - (viii) JAA AMJ 20X2;
 - (ix) FAA AC 20-130A for en route operations;
 - (x) FAA AC 20-138 for en route operations; and
 - (xi) FAA AC 90-96.
- (h) RNAV 1/RNAV 2

-
- (1) If a statement of compliance with any of the following specifications or standards is found in the acceptable documentation as listed above, the aircraft is eligible for RNAV 1/RNAV 2 operations.
 - (i) RNAV 1;
 - (ii) PRNAV;
 - (iii) US RNAV type A;
 - (iv) FAA AC 20-138 for the appropriate navigation specification;
 - (v) FAA AC 90-100A;
 - (vi) JAA TEMPORARY GUIDANCE MATERIAL, LEAFLET NO. 10 Rev1 (TGL 10); and
 - (vii) FAA AC 90-100.
 - (2) However, if position determination is exclusively computed based on VOR-DME, the aircraft is not eligible for RNAV 1/RNAV 2 operations.
- (i) RNP 1/RNP 2 continental
- (1) If a statement of compliance with any of the following specifications or standards is found in the acceptable documentation as listed above, the aircraft is eligible for RNP 1/RNP 2 continental operations.
 - (i) A-RNP;
 - (ii) FAA AC 20-138 for the appropriate navigation specification; and
 - (iii) FAA AC 90-105.
 - (2) Alternatively, if a statement of compliance with any of the following specifications or standards is found in the acceptable documentation as listed above and position determination is primarily based on GNSS, the aircraft is eligible for RNP 1/RNP 2 continental operations. However, in these cases, loss of GNSS implies loss of RNP 1/RNP 2 capability.
 - (i) JAA TEMPORARY GUIDANCE MATERIAL, LEAFLET NO. 10 (TGL 10) (any revision); and
 - (ii) FAA AC 90-100.
- (j) RNP APCH — LNAV minima
- (1) If a statement of compliance with any of the following specifications or standards is found in the acceptable documentation as listed above, the aircraft is eligible for RNP APCH — LNAV operations.
 - (i) A-RNP;
 - (ii) AMC 20-27;
 - (iii) AMC 20-28;
 - (iv) FAA AC 20-138 for the appropriate navigation specification; and
 - (v) FAA AC 90-105 for the appropriate navigation specification.
 - (2) Alternatively, if a statement of compliance with RNP 0.3 GNSS approaches in accordance with any of the following specifications or standards is found in the acceptable documentation as listed above, the aircraft is eligible for RNP APCH — LNAV operations. Any limitation such as ‘within the US National Airspace’ may be ignored since RNP APCH procedures are assumed to meet the same ICAO criteria around the world.

- (i) JAA TEMPORARY GUIDANCE MATERIAL, LEAFLET NO. 3 (TGL 3);
 - (ii) AMC 20-4;
 - (iii) FAA AC 20-130A; and
 - (iv) FAA AC 20-138.
- (k) RNP APCH — LNAV/VNAV minima
- (1) If a statement of compliance with any of the following specifications or standards is found in the acceptable documentation as listed above, the aircraft is eligible for RNP APCH — LNAV/VNAV operations.
 - (i) A-RNP;
 - (ii) AMC 20-27 with Baro VNAV;
 - (iii) AMC 20-28;
 - (iv) FAA AC 20-138; and
 - (v) FAA AC 90-105 for the appropriate navigation specification.
 - (2) Alternatively, if a statement of compliance with FAA AC 20-129 is found in the acceptable documentation as listed above, and the aircraft complies with the requirements and limitations of EASA SIB 2014-04⁶, the aircraft is eligible for RNP APCH — LNAV/VNAV operations. Any limitation such as ‘within the US National Airspace’ may be ignored since RNP APCH procedures are assumed to meet the same ICAO criteria around the world.
- (l) RNP APCH — LPV minima
- (1) If a statement of compliance with any of the following specifications or standards is found in the acceptable documentation as listed above, the aircraft is eligible for RNP APCH — LPV operations.
 - (i) AMC 20-28;
 - (ii) FAA AC 20-138 for the appropriate navigation specification; and
 - (iii) FAA AC 90-107.
 - (2) For aircraft that have a TAWS Class A installed and do not provide Mode-5 protection on an LPV approach, the DH is limited to 250 ft.
- (m) RNAV 10
- (1) If a statement of compliance with any of the following specifications or standards is found in the acceptable documentation as listed above, the aircraft is eligible for RNAV 10 operations.
 - (i) RNP 10;
 - (ii) FAA AC 20-138 for the appropriate navigation specification;
 - (iii) AMC 20-12;
 - (iv) FAA Order 8400.12 (or later revision); and
 - (v) FAA AC 90-105.
- (n) RNP 4

⁶ <http://ad.easa.europa.eu/ad/2014-04>

- (1) If a statement of compliance with any of the following specifications or standards is found in the acceptable documentation as listed above, the aircraft is eligible for RNP 4 operations.
 - (i) FAA AC 20-138B or later, for the appropriate navigation specification;
 - (ii) FAA Order 8400.33; and
 - (iii) FAA AC 90-105 for the appropriate navigation specification.
- (o) RNP 2 oceanic
 - (1) If a statement of compliance with FAA AC 90-105 for the appropriate navigation specification is found in the acceptable documentation as listed above, the aircraft is eligible for RNP 2 oceanic operations.
 - (2) If the aircraft has been assessed eligible for RNP 4, the aircraft is eligible for RNP 2 oceanic.
- (p) Special features
 - (1) RF in terminal operations (used in RNP 1 and in the initial segment of the RNP APCH)
 - (i) If a statement of demonstrated capability to perform an RF leg, certified in accordance with any of the following specifications or standards, is found in the acceptable documentation as listed above, the aircraft is eligible for RF in terminal operations:
 - (A) AMC 20-26; and
 - (B) FAA AC 20-138B or later.
 - (ii) If there is a reference to RF and a reference to compliance with AC 90-105, then the aircraft is eligible for such operations.
- (q) Other considerations
 - (1) In all cases, the limitations in the AFM/POH need to be checked, in particular the use of AP or FD which can be required to reduce the FTE primarily for RNP APCH, RNAV 1, and RNP 1.
 - (2) Any limitation such as 'within the US National Airspace' may be ignored since RNP APCH procedures are assumed to meet the same ICAO criteria around the world.

GM3 NCO.IDE.H.195 Navigation equipment

GENERAL

- (a) The PBN specifications for which the aircraft complies with the relevant airworthiness criteria are set out in the AFM/POH, together with any limitations to be observed.
- (b) Because functional and performance requirements are defined for each navigation specification, an aircraft approved for an RNP specification is not automatically approved for all RNAV specifications. Similarly, an aircraft approved for an RNP or RNAV specification having a stringent accuracy requirement (e.g. RNP 0.3 specification) is not automatically approved for a navigation specification having a less stringent accuracy requirement (e.g. RNP 4).

RNP 4

- (c) For RNP 4, at least two LRNSs, capable of navigating to RNP 4, and listed in the AFM/POH, may be operational at the entry point of the RNP 4 airspace. If an item of equipment required for RNP 4 operations is unserviceable, then the pilot-in-command may consider an alternate route

or diversion for repairs. For multi-sensor systems, the AFM/POH may permit entry if one GNSS sensor is lost after departure, provided one GNSS and one inertial sensor remain available.

NCO.IDE.H.200 Transponder

Where required by the airspace being flown, helicopters shall be equipped with a secondary surveillance radar (SSR) transponder with all the required capabilities.

AMC1 NCO.IDE.H.200 Transponder

GENERAL

- (a) The secondary surveillance radar (SSR) transponders of helicopters being operated under European air traffic control should comply with any applicable Single European Sky legislation.
- (b) If the Single European Sky legislation is not applicable, the SSR transponders should operate in accordance with the relevant provisions of Volume IV of ICAO Annex 10.

NCO.IDE.H.205 Management of aeronautical databases

Applicable
from 01
January 2019

- (a) Aeronautical databases used on certified aircraft system applications shall meet data quality requirements that are adequate for the intended use of the data.
- (b) The pilot-in-command shall ensure the timely distribution and insertion of current and unaltered aeronautical databases to the aircraft that require them.
- (c) Notwithstanding any other occurrence reporting requirements as defined in Regulation (EU) No 376/2014, the pilot-in-command shall report to the database provider instances of erroneous, inconsistent or missing data that might be reasonably expected to constitute a hazard to flight.
In such cases, the pilot-in-command shall not use the affected data.

SECTION 3
Sailplanes**NCO.IDE.S.100 Instruments and equipment — general**

- (a) Instruments and equipment required by this Subpart shall be approved in accordance with the applicable airworthiness requirements if they are:
- (1) used by the flight crew to control the flight path;
 - (2) used to to comply with NCO.IDE.S.145;
 - (3) used to comply with NCO.IDE.S.150; or
 - (4) installed in the sailplane.
- (b) The following items, when required by this Subpart, do not need an equipment approval:
- (1) independent portable lights;
 - (2) an accurate time piece;
 - (3) survival and signalling equipment.
- (c) Instruments and equipment not required by this Subpart as well as any other equipment that is not required by other Annexes, but is carried on a flight, shall comply with the following:
- (1) the information provided by these instruments or, equipment shall not be used by the flight crew to comply with Annex I to Regulation (EC) No 216/2008; and
 - (2) the instruments and equipment shall not affect the airworthiness of the sailplane, even in the case of failures or malfunction.
- (d) Instruments and equipment shall be readily operable or accessible from the station where the flight crew member that needs to use it is seated.
- (e) All required emergency equipment shall be easily accessible for immediate use.

GM1 NCO.IDE.S.100(a) Instruments and equipment — general

APPLICABLE AIRWORTHINESS REQUIREMENTS

The applicable airworthiness requirements for approval of instruments and equipment required by this Part are the following:

- (a) Regulation (EU) No 748/2012 for sailplanes registered in the EU; and
- (b) Airworthiness requirements of the State of registry for sailplanes registered outside the EU.

GM1 NCO.IDE.S.100(b) Instruments and equipment — general

REQUIRED INSTRUMENTS AND EQUIPMENT THAT DO NOT NEED TO BE APPROVED IN ACCORDANCE WITH THE APPLICABLE AIRWORTHINESS REQUIREMENTS

The functionality of non-installed instruments and equipment required by this Subpart and that do not need an equipment approval, as listed in NCO.IDE.S.100(b), should be checked against recognised industry standards appropriate to the intended purpose. The operator is responsible for ensuring the maintenance of these instruments and equipment.

GM1 NCO.IDE.S.100(c) Instruments and equipment — general

NOT REQUIRED INSTRUMENTS AND EQUIPMENT THAT DO NOT NEED TO BE APPROVED IN ACCORDANCE WITH THE APPLICABLE AIRWORTHINESS REQUIREMENTS, BUT ARE CARRIED ON A FLIGHT

- (a) The provision of this paragraph does not exempt any installed instrument or item of equipment from complying with the applicable airworthiness requirements. In this case, the installation should be approved as required in the applicable airworthiness requirements and should comply with the applicable Certification Specifications.
- (b) The failure of additional non-installed instruments or equipment not required by this Part or by the applicable airworthiness requirements or any applicable airspace requirements should not adversely affect the airworthiness and/or the safe operation of the sailplane. Examples may be portable electronic devices carried by crew members or passengers.

NCO.IDE.S.105 Minimum equipment for flight

A flight shall not be commenced when any of the sailplane instruments, items of equipment or functions required for the intended flight are inoperative or missing, unless:

- (a) the sailplane is operated in accordance with the MEL, if established; or
- (b) the sailplane is subject to a permit to fly issued in accordance with the applicable airworthiness requirements.

NCO.IDE.S.115 Operations under VFR — flight and navigational instruments

- (a) Sailplanes operated under VFR by day shall be equipped with a means of measuring and displaying the following:
 - (1) in the case of powered sailplanes, magnetic heading;
 - (2) time in hours, minutes and seconds;
 - (3) pressure altitude; and
 - (4) indicated airspeed.
- (b) Sailplanes operating in conditions where the sailplane cannot be maintained in a desired flight path without reference to one or more additional instruments, shall be, in addition to (a), equipped with a means of measuring and displaying the following:
 - (1) vertical speed;
 - (2) attitude or turn and slip; and
 - (3) magnetic heading.

AMC1 NCO.IDE.S.115&NCO.IDE.S.120 Operations under VFR & cloud flying — flight and navigational instruments**INTEGRATED INSTRUMENTS**

- (a) Individual equipment requirements may be met by combinations of instruments or by integrated flight systems or by a combination of parameters on electronic displays. The information so available to each required pilot should not be less than that required in the applicable operational requirements, and the equivalent safety of the installation should be approved during type certification of the sailplane for the intended type of operation.
- (b) The means of measuring and indicating turn and slip and sailplane attitude may be met by combinations of instruments, provided that the safeguards against total failure, inherent in the three separate instruments, are retained.

AMC1 NCO.IDE.S.115(a)(1)&NCO.IDE.S.120(a) Operations under VFR & cloud flying — flight and navigational instruments**MEANS OF MEASURING AND DISPLAYING MAGNETIC HEADING**

The means of measuring and displaying magnetic direction should be a magnetic compass or equivalent.

AMC1 NCO.IDE.S.115(a)(2)&NCO.IDE.S.120(b) Operations under VFR & cloud flying — flight and navigational instruments

MEANS OF MEASURING AND DISPLAYING THE TIME

A means of measuring and displaying the time in hours, minutes and seconds may be a wrist watch capable of the same functions.

AMC1 NCO.IDE.S.115(a)(3)&NCO.IDE.S.120(c) Operations under VFR & cloud flying — flight and navigational instruments

CALIBRATION OF THE MEANS FOR MEASURING AND DISPLAYING PRESSURE ALTITUDE

- (a) The instrument measuring and displaying pressure altitude should be of a sensitive type calibrated in feet (ft), with a sub-scale setting, calibrated in hectopascals/millibars, adjustable for any barometric pressure likely to be set during flight.
- (b) Calibration in metres (m) is also acceptable.

AMC1 NCO.IDE.S.115(a)(4)&NCO.IDE.S.120(d) Operations under VFR & cloud flying — flight and navigational instruments

CALIBRATION OF THE INSTRUMENT INDICATING AIRSPEED

- (a) The instrument indicating airspeed should be calibrated in knots (kt).
- (b) Calibration in kilometres per hour (kph) or in miles per hour (mph) is also acceptable.

AMC1 NCO.IDE.S.115(b)(2) Operations under VFR — flight and navigational instruments

SLIP INDICATION

The means of measuring and displaying slip may be a yaw string for operations under VFR.

GM1 NCO.IDE.S.115(b) Operations under VFR — flight and navigational instruments

CONDITIONS WHERE THE SAILPLANE CANNOT BE MAINTAINED IN A DESIRED ATTITUDE WITHOUT REFERENCE TO ONE OR MORE ADDITIONAL INSTRUMENTS

Sailplanes operating in conditions where the sailplane cannot be maintained in a desired attitude without reference to one or more additional instruments means a condition that is still under VFR (under VMC) though where there is no external reference such as the natural horizon or a coastline, that would allow the attitude to be maintained. Such conditions may occur over water, a desert or snow-covered areas where the colour of the surface cannot be distinguished from the colour of the sky and therefore no external reference is available. Cloud flying is not considered to be one of these conditions.

NCO.IDE.S.120 Cloud flying — flight and navigational instruments

Sailplanes performing cloud flying shall be equipped with a means of measuring and displaying the following:

- (a) magnetic heading;
- (b) time in hours, minutes and seconds;
- (c) pressure altitude;
- (d) indicated airspeed;
- (e) vertical speed; and
- (f) attitude or turn and slip.

NCO.IDE.S.125 Seats and restraint systems

- (a) Sailplanes shall be equipped with:
 - (1) a seat for each person on board; and
 - (2) a seat belt with upper torso restraint system for each seat according to the AFM.
- (b) A seat belt with upper torso restraint system shall have a single point release.

AMC1 NCO.IDE.S.125 Seats and restraint systems**UPPER TORSO RESTRAINT SYSTEM**

- (a) A seat belt with upper torso restraint system should have four anchorage points and should include shoulder straps (two anchorage points) and a seat belt (two anchorage points), which may be used independently.
- (b) A restraint system having five anchorage points is deemed to be compliant to the requirement for seat belt with upper torso restraint system with four anchorage points.

NCO.IDE.S.130 Supplemental oxygen

Sailplanes operated when an oxygen supply is required in accordance with NCO.OP.190 shall be equipped with oxygen storage and dispensing apparatus capable of storing and dispensing the required oxygen supplies.

AMC 1 NCO.IDE.S.130 Supplemental oxygen supply**OXYGEN SUPPLY**

The need for oxygen supply, when required by NCO.OP.190, may be met either by means of installed equipment or portable equipment.

NCO.IDE.S.135 Flight over water

The pilot-in-command of a sailplane operated over water shall determine the risks to survival of the occupants of the sailplane in the event of a ditching, based on which he/she shall determine the carriage of:

- (a) a life-jacket, or equivalent individual floatation device, for each person on board, that shall be worn or stowed in a position that is readily accessible from the seat of the person for whose use it is provided;
- (b) an emergency locator transmitter (ELT) or a personal locator beacon (PLB), carried by a crew member or a passenger, capable of transmitting simultaneously on 121,5 MHz and 406 MHz; and
- (c) equipment for making distress signals, when operating a flight:
 - (1) over water beyond gliding distance from land; or
 - (2) where the take-off or approach path is so disposed over water that in the event of a mishap there would be a likelihood of ditching.

AMC1 NCO.IDE.S.135 Flight over water

MEANS OF ILLUMINATION FOR LIFE-JACKETS

Each life-jacket or equivalent individual floatation device should be equipped with a means of electric illumination for the purpose of facilitating the location of persons.

RISK ASSESSMENT

- (a) When conducting the risk assessment, the pilot-in-command should base his/her decision, as far as is practicable, on the Implementing Rules and AMCs applicable to the operation of the sailplane.
- (b) The pilot-in-command should, for determining the risk, take the following operating environment and conditions into account:
 - (1) sea state;
 - (2) sea and air temperatures;
 - (3) the distance from land suitable for making an emergency landing; and
 - (4) the availability of search and rescue facilities.

GM1 NCO.IDE.S.135(a) Flight over water

SEAT CUSHIONS

Seat cushions are not considered to be flotation devices.

AMC1 NCO.IDE.S.135(b) Flight over water

BATTERIES

- (a) All batteries used in ELTs or PLBs should be replaced (or recharged, if the battery is rechargeable) when the equipment has been in use for more than 1 cumulative hour or in the following cases:
 - (1) Batteries specifically designed for use in ELTs and having an airworthiness release certificate (EASA Form 1 or equivalent) should be replaced (or recharged, if the battery is

- rechargeable) before the end of their useful life in accordance with the maintenance instructions applicable to the ELT.
- (2) Standard batteries manufactured in accordance with an industry standard and not having an airworthiness release certificate (EASA Form 1 or equivalent), when used in ELTs should be replaced (or recharged, if the battery is rechargeable) when 50 % of their useful life (or for rechargeable, 50 % of their useful life of charge), as established by the battery manufacturer, has expired.
 - (3) All batteries used in PLBs should be replaced (or recharged, if the battery is rechargeable) when 50 % of their useful life (or for rechargeable, 50 % of their useful life of charge), as established by the battery manufacturer, has expired.
 - (4) The battery useful life (or useful life of charge) criteria in (1),(2) and (3) do not apply to batteries (such as water-activated batteries) that are essentially unaffected during probable storage intervals.
- (b) The new expiry date for a replaced (or recharged) battery should be legibly marked on the outside of the equipment.

AMC2 NCO.IDE.S.135(b) Flight over water

TYPES OF ELT AND GENERAL TECHNICAL SPECIFICATIONS

- (a) The ELT required by this provision should be one of the following:
- (1) Automatic fixed (ELT(AF)). An automatically activated ELT that is permanently attached to an aircraft and is designed to aid SAR teams in locating the crash site.
 - (2) Automatic portable (ELT(AP)). An automatically activated ELT that is rigidly attached to an aircraft before a crash, but is readily removable from the aircraft after a crash. It functions as an ELT during the crash sequence. If the ELT does not employ an integral antenna, the aircraft-mounted antenna may be disconnected and an auxiliary antenna (stored on the ELT case) attached to the ELT. The ELT can be tethered to a survivor or a life-raft. This type of ELT is intended to aid SAR teams in locating the crash site or survivor(s).
 - (3) Automatic Deployable (ELT(AD)). An ELT that is rigidly attached to the aircraft before the crash and that is automatically ejected, deployed and activated by an impact, and, in some cases, also by hydrostatic sensors. Manual deployment is also provided. This type of ELT should float in water and is intended to aid SAR teams in locating the crash site.
 - (4) Survival ELT (ELT(S)). An ELT that is removable from an aircraft, stowed so as to facilitate its ready use in an emergency and manually activated by a survivor. An ELT(S) may be activated manually or automatically (e.g. by water activation). It should be designed either to be tethered to a life-raft or a survivor.
- (b) To minimise the possibility of damage in the event of crash impact, the automatic ELT should be rigidly fixed to the aircraft structure, as far aft as is practicable, with its antenna and connections arranged so as to maximise the probability of the signal being transmitted after a crash.
- (c) Any ELT carried should operate in accordance with the relevant provisions of ICAO Annex 10, Volume III, and should be registered with the national agency responsible for initiating search and rescue or other nominated agency.

AMC3 NCO.IDE.S.135(b) Flight over water

PLB TECHNICAL SPECIFICATIONS

- (a) A personal locator beacon (PLB) should have a built-in GNSS receiver with a *cosmicheskaya sistyema poiska avariynich sudov* — search and rescue satellite-aided tracking (COSPAS-SARSAT) type approval number. However, devices with a COSPAS-SARSAT number belonging to series 700 are excluded as this series of numbers identifies the special-use beacons not meeting all the technical requirements and all the tests specified by COSPAS-SARSAT.
- (b) Any PLB carried should be registered with the national agency responsible for initiating search and rescue or other nominated agency.

AMC4 NCO.IDE.S.135(b) Flight over water

BRIEFING ON PLB USE

When a PLB is carried by a passenger, he/she should be briefed on its characteristics and use by the pilot-in-command before the flight.

GM1 NCO.IDE.S.135(b) Flight over water

TERMINOLOGY

- (a) An ELT is a generic term describing equipment that broadcasts distinctive signals on designated frequencies and, depending on application, may be activated by impact or may be manually activated.
- (b) A PLB is an emergency beacon other than an ELT that broadcasts distinctive signals on designated frequencies, is standalone, portable and is manually activated by the survivors.

NCO.IDE.S.140 Survival equipment

Sailplanes operated over areas in which search and rescue would be especially difficult shall be equipped with such signalling devices and life-saving equipment as appropriate to the area overflown.

AMC1 NCO.IDE.S.140 Survival equipment

GENERAL

Sailplanes operated across land areas in which search and rescue would be especially difficult should be equipped with the following:

- (a) signalling equipment to make the distress signals;
- (b) at least one ELT(S) or a PLB; and
- (c) additional survival equipment for the route to be flown taking account of the number of persons on board.

AMC2 NCO.IDE.S.140 Survival equipment

ADDITIONAL SURVIVAL EQUIPMENT

- (a) The following additional survival equipment should be carried when required:
 - (1) 500 ml of water;
 - (2) one knife;
 - (3) first-aid equipment; and
 - (4) one set of air/ground codes.
- (b) If any item of equipment contained in the above list is already carried on board the sailplane in accordance with another requirement, there is no need for this to be duplicated.

GM1 NCO.IDE.S.140 Survival equipment

SIGNALLING EQUIPMENT

The signalling equipment for making distress signals is described in ICAO Annex 2, Rules of the Air.

GM2 NCO.IDE.S.140 Survival equipment

AREAS IN WHICH SEARCH AND RESCUE WOULD BE ESPECIALLY DIFFICULT

The expression 'areas in which search and rescue would be especially difficult' should be interpreted, in this context, as meaning:

- (a) areas so designated by the authority responsible for managing search and rescue; or
- (b) areas that are largely uninhabited and where:
 - (1) the authority referred to in (a) has not published any information to confirm whether search and rescue would be or would not be especially difficult; and
 - (2) the authority referred to in (a) does not, as a matter of policy, designate areas as being especially difficult for search and rescue.

NCO.IDE.S.145 Radio communication equipment

- (a) Where required by the airspace being flown sailplanes shall be equipped with radio communication equipment capable of conducting two-way communication with those aeronautical stations or those frequencies to meet airspace requirements.
- (b) Radio communication equipment, if required by (a), shall provide for communication on the aeronautical emergency frequency 121,5 MHz.

NCO.IDE.S.150 Navigation equipment

Sailplanes shall be equipped with any navigation equipment necessary to proceed in accordance with:

- (a) the ATS flight plan if applicable; and
- (b) the applicable airspace requirements.

GM1 NCO.IDE.S.150 Navigation equipment**APPLICABLE AIRSPACE REQUIREMENTS**

For sailplanes being operated under European air traffic control, the applicable airspace requirements include the Single European Sky legislation.

NCO.IDE.S.155 Transponder

When required by the airspace being flown, sailplanes shall be equipped with a secondary surveillance radar (SSR) transponder with all the required capabilities.

AMC1 NCO.IDE.S.155 Transponder

GENERAL

- (a) The secondary surveillance radar (SSR) transponders of sailplanes being operated under European air traffic control should comply with any applicable Single European Sky legislation.
- (b) If the Single European Sky legislation is not applicable, the SSR transponders should operate in accordance with the relevant provisions of Volume IV of ICAO Annex 10.

SECTION 4
Balloons**NCO.IDE.B.100 Instruments and equipment — general**

- (a) Instruments and equipment required by this Subpart shall be approved in accordance with the applicable airworthiness requirements if they are:
- (1) used by the flight crew to determine the flight path;
 - (2) used to comply with NCO.IDE.B.145; or
 - (3) installed in the balloon.
- (b) The following items, when required by this Subpart, do not need an equipment approval:
- (1) independent portable lights;
 - (2) an accurate time piece;
 - (3) first-aid kit;
 - (4) survival and signalling equipment.
- (c) Instruments and equipment not required by this Subpart as well as any other equipment that is not required by other Annexes, but is carried on a flight, shall comply with the following:
- (1) the information provided by these instruments or equipment shall not be used by the flight crew to comply with Annex I to Regulation (EC) No 216/2008; and
 - (2) the instruments and equipment shall not affect the airworthiness of the balloon, even in the case of failures or malfunction.
- (d) Instruments and equipment shall be readily operable or accessible from the station where the flight crew member that needs to use it is assigned.
- (e) All required emergency equipment shall be easily accessible for immediate use.

GM1 NCO.IDE.B.100(a) Instruments and equipment — general

APPLICABLE AIRWORTHINESS REQUIREMENTS

The applicable airworthiness requirements for approval of instruments and equipment required by this Part are the following:

- (a) Regulation (EU) No 748/2012 for balloons registered in the EU; and
- (b) Airworthiness requirements of the state of registry for balloons registered outside the EU.

GM1 NCO.IDE.B.100(b) Instruments and equipment — general

REQUIRED INSTRUMENTS AND EQUIPMENT THAT DO NOT NEED TO BE APPROVED IN ACCORDANCE WITH THE APPLICABLE AIRWORTHINESS REQUIREMENTS

The functionality of non-installed instruments and equipment required by this Subpart and that do not need an equipment approval, as listed in NCO.IDE.B.100(b), should be checked against recognised industry standards appropriate to the intended purpose. The operator is responsible for ensuring the maintenance of these instruments and equipment.

GM1 NCO.IDE.B.100(c) Instruments and equipment — general

NOT REQUIRED INSTRUMENTS AND EQUIPMENT THAT DO NOT NEED TO BE APPROVED IN ACCORDANCE WITH THE APPLICABLE AIRWORTHINESS REQUIREMENTS, BUT ARE CARRIED ON A FLIGHT

- (a) The provision of this paragraph does not exempt any installed instrument or item of equipment from complying with the applicable airworthiness requirements. In this case, the installation should be approved as required in the applicable airworthiness requirements and should comply with the applicable Certification Specifications.
- (b) The failure of additional non-installed instruments or equipment not required by this Part or by the applicable airworthiness requirements or any applicable airspace requirements should not adversely affect the airworthiness and/or the safe operation of the balloon. Examples may be portable electronic devices carried by crew members or passengers.

NCO.IDE.B.105 Minimum equipment for flight

A flight shall not be commenced when any of the balloon instruments, items of equipment or functions required for the intended flight are inoperative or missing, unless:

- (a) the balloon is operated in accordance with the MEL, if established; or
- (b) the balloon is subject to a permit to fly issued in accordance with the applicable airworthiness requirements.

NCO.IDE.B.110 Operating lights

Balloons operated at night shall be equipped with:

- (a) anti-collision lights;
- (b) a means to provide adequate illumination for all instruments and equipment essential to the safe operation of the balloon; and
- (c) an independent portable light.

AMC1 NCO.IDE.B.110 Operating lights**ANTI-COLLISION LIGHTS**

An acceptable means of compliance is the anti-collision light required for free manned balloons certified for VFR at night in accordance with CS 31HB/GB.

ILLUMINATION FOR INSTRUMENTS AND EQUIPMENT

A means of providing adequate illumination to instruments and equipment essential to the safe operation of the balloon may be an independent portable light.

NCO.IDE.B.115 Operations under VFR — flight and navigational instruments and associated equipment

Balloons operated under VFR by day shall be equipped with the following:

- (a) a means of displaying drift direction; and
- (b) a means of measuring and displaying:
 - (1) time in hours, minutes and seconds;
 - (2) vertical speed, if required by the AFM; and
 - (3) pressure altitude, if required by the AFM, if required by airspace requirements or when altitude needs to be controlled for the use of oxygen.

AMC1 NCO.IDE.B.115(a) Operations under VFR — flight and navigational instruments**MEANS OF DISPLAYING DRIFT DIRECTION**

The drift direction may be determined by using a map and reference to visual landmarks.

AMC1 NCO.IDE.B.115(b)(1) Operations under VFR — flight and navigational instruments**MEANS OF MEASURING AND DISPLAYING THE TIME**

A means of measuring and displaying the time in hours, minutes and seconds may be a wrist watch capable of the same functions.

GM1 NCO.IDE.B.115(b)(2) Operations under VFR — flight and navigational instruments**MEANS OF MEASURING AND DISPLAYING VERTICAL SPEED**

The necessity of a vertical speed indicator depends on the balloon design. Some envelope shapes have a high drag and will therefore not develop a high ascent/descent speed. Such balloons usually do not require a vertical speed indicator. More slender envelope shapes such as special shape balloons may have a significantly lower drag. Their ascent/descent speed is usually limited to a certain value so that controllability of the balloon is maintained. To be able to stay within this limitation of the AFM, a vertical speed indicator is required for such balloons.

GM1 NCO.IDE.B.115(b)(3) Operations under VFR — flight and navigational instruments and associated equipment**MEANS OF MEASURING AND DISPLAYING PRESSURE ALTITUDE**

A means of measuring and displaying pressure altitude is needed when required by ATC, or by Regulation (EU) 923/2012, or when altitude needs to be checked for flights where oxygen is used, or the limitations in the AFM require to limit altitude and/or rate of climb/descent.

NCO.IDE.B.120 First-aid kit

- (a) Balloons shall be equipped with a first-aid kit.
- (b) The first-aid kit shall be:
 - (1) readily accessible for use; and
 - (2) kept up-to-date.

AMC1 NCO.IDE.B.120 First-aid kit

CONTENT OF FIRST-AID KITS

- (a) First-aid kits should be equipped with appropriate and sufficient medications and instrumentation. However, these kits should be amended by the operator according to the characteristics of the operation (scope of operation, flight duration, number and demographics of passengers, etc.).
- (b) The following should be included in the FAKs:
 - (1) bandages (assorted sizes),
 - (2) burns dressings (large and small),
 - (3) wound dressings (large and small),
 - (4) adhesive dressings (assorted sizes),
 - (5) antiseptic wound cleaner,
 - (6) safety scissors,
 - (7) disposable gloves.

AMC2 NCO.IDE.B.120 First-aid kit

MAINTENANCE OF FIRST-AID KIT

To be kept up-to-date, first-aid kits should be:

- (a) inspected periodically to confirm, to the extent possible, that contents are maintained in the condition necessary for their intended use;
- (b) replenished at regular intervals, in accordance with instructions contained on their labels, or as circumstances warrant; and
- (c) replenished after use in-flight at the first opportunity where replacement items are available.

NCO.IDE.B.121 Supplemental oxygen

Balloons operated at pressure altitudes above 10 000 ft shall be equipped with an oxygen storage and dispensing apparatus carrying enough breathing oxygen to supply:

- (a) crew members for any period in excess of 30 minutes when the pressure altitude will be between 10 000 ft and 13 000 ft; and
- (b) all crew members and passengers for any period that the pressure altitude will be above 13 000 ft.

NCO.IDE.B.125 Hand fire extinguishers

Hot air -balloons shall be equipped with at least one hand fire extinguisher, if required by the applicable certification specifications.

AMC1 NCO.IDE.B.125 Hand fire extinguishers**CERTIFICATION SPECIFICATIONS**

The applicable Certification Specification for hot-air balloons should be CS-31HB or equivalent.

NCO.IDE.B.130 Flight over water

The pilot-in-command of a balloon operated over water shall determine the risks to survival of the occupants of the balloon in the event of a ditching, based on which he/she shall determine the carriage of:

- (a) a life-jacket for each person on board, or equivalent individual floatation device for each person on board younger than 24 months, that shall be worn or stowed in a position that is readily accessible from the station of the person for whose use it is provided;
- (b) when carrying more than 6 persons, an emergency locator transmitter (ELT) capable of transmitting simultaneously on 121,5 MHz and 406 MHz;
- (c) when carrying up to 6 persons, an ELT or a personal locator beacon (PLB), carried by a crew member or a passenger, capable of transmitting simultaneously on 121,5 MHz and 406 MHz; and
- (d) equipment for making the distress signals.

AMC1 NCO.IDE.B.130 Flight over water**MEANS OF ILLUMINATION FOR LIFE-JACKETS**

Each life-jacket or equivalent individual flotation device should be equipped with a means of electric illumination for the purpose of facilitating the location of persons.

RISK ASSESSMENT

- (a) When conducting the risk assessment, the pilot-in-command should base his/her decision, as far as is practicable, on the Implementing Rules and AMCs applicable to the operation of the balloon.
- (b) The pilot-in-command should, for determining the risk, take the following operating environment and conditions into account:
 - (1) sea state;
 - (2) sea and air temperatures;
 - (3) the distance from land suitable for making an emergency landing; and
 - (4) the availability of search and rescue facilities.

AMC1 NCO.IDE.B.130(b) Flight over water**BATTERIES**

- (a) All batteries used in ELTs or PLBs should be replaced (or recharged, if the battery is rechargeable) when the equipment has been in use for more than 1 cumulative hour or in the following cases:
 - (1) Batteries specifically designed for use in ELTs and having an airworthiness release certificate (EASA Form 1 or equivalent) should be replaced (or recharged, if the battery is rechargeable) before the end of their useful life in accordance with the maintenance instructions applicable to the ELT.
 - (2) Standard batteries manufactured in accordance with an industry standard and not having an airworthiness release certificate (EASA Form 1 or equivalent), when used in ELTs should be replaced (or recharged, if the battery is rechargeable) when 50 % of their useful life (or

for rechargeable, 50 % of their useful life of charge), as established by the battery manufacturer, has expired.

- (3) All batteries used in PLBs should be replaced (or recharged, if the battery is rechargeable) when 50 % of their useful life (or for rechargeable, 50 % of their useful life of charge), as established by the battery manufacturer, has expired.
 - (4) The battery useful life (or useful life of charge) criteria in (1),(2) and (3) do not apply to batteries (such as water-activated batteries) that are essentially unaffected during probable storage intervals.
- (b) The new expiry date for a replaced (or recharged) battery should be legibly marked on the outside of the equipment.

AMC2 NCO.IDE.B.130(b) Flight over water

TYPES OF ELT AND GENERAL TECHNICAL SPECIFICATIONS

- (a) The ELT required by this provision should be one of the following:
- (1) Automatic fixed (ELT(AF)). An automatically activated ELT that is permanently attached to an aircraft and is designed to aid SAR teams in locating the crash site.
 - (2) Automatic portable (ELT(AP)). An automatically activated ELT that is rigidly attached to an aircraft before a crash, but is readily removable from the aircraft after a crash. It functions as an ELT during the crash sequence. If the ELT does not employ an integral antenna, the aircraft-mounted antenna may be disconnected and an auxiliary antenna (stored on the ELT case) attached to the ELT. The ELT can be tethered to a survivor or a life-raft. This type of ELT is intended to aid SAR teams in locating the crash site or survivor(s).
 - (3) Automatic deployable (ELT(AD)). An ELT that is rigidly attached to the aircraft before the crash and which is automatically ejected, deployed and activated by an impact, and, in some cases, also by hydrostatic sensors. Manual deployment is also provided. This type of ELT should float in water and is intended to aid SAR teams in locating the crash site.
 - (4) Survival ELT (ELT(S)). An ELT that is removable from an aircraft, stowed so as to facilitate its ready use in an emergency and manually activated by a survivor. An ELT(S) may be activated manually or automatically (e.g. by water activation). It should be designed either to be tethered to a life-raft or a survivor.
- (b) To minimise the possibility of damage in the event of crash impact, the automatic ELT should be rigidly fixed to the aircraft structure, as far aft as is practicable, with its antenna and connections arranged so as to maximise the probability of the signal being transmitted after a crash.
- (c) Any ELT carried should operate in accordance with the relevant provisions of ICAO Annex 10, Volume III, and should be registered with the national agency responsible for initiating search and rescue or other nominated agency.

AMC3 NCO.IDE.B.130(b) Flight over water

PLB TECHNICAL SPECIFICATIONS

- (a) A personal locator beacon (PLB) should have a built-in GNSS receiver with a *cosmicheskaya sistyema poiska avariynich sudov* — search and rescue satellite-aided tracking (COSPAS-SARSAT) type approval number. However, devices with a COSPAS-SARSAT number belonging to series 700 are excluded as this series of numbers identifies the special-use beacons not meeting all the technical requirements and all the tests specified by COSPAS-SARSAT.

- (b) Any PLB carried should be registered with the national agency responsible for initiating search and rescue or other nominated agency.

AMC4 NCO.IDE.B.130(b) Flight over water

BRIEFING ON PLB USE

When a PLB is carried by a passenger, he/she should be briefed on its characteristics and use by the pilot-in-command before the flight.

GM1 NCO.IDE.B.130(b) Flight over water

TERMINOLOGY

- (a) An ELT is a generic term describing equipment that broadcasts distinctive signals on designated frequencies and, depending on application, may be activated by impact or may be manually activated.
- (b) A PLB is an emergency beacon other than an ELT that broadcasts distinctive signals on designated frequencies, is standalone, portable and is manually activated by the survivors.

GM1 NCO.IDE.B.130(d) Survival equipment

SIGNALLING EQUIPMENT

The signalling equipment for making distress signals is described in ICAO Annex 2, Rules of the Air.

NCO.IDE.B.135 Survival equipment

Balloons operated over areas in which search and rescue would be especially difficult shall be equipped with such signalling devices and life-saving equipment as appropriate to the area overflown.

AMC1 NCO.IDE.B.135 Survival equipment

GENERAL

Balloons operated across land areas in which search and rescue would be especially difficult should be equipped with the following:

- (a) signalling equipment to make the distress signals;
- (b) at least one ELT(S) or a PLB; and
- (c) additional survival equipment for the route to be flown taking account of the number of persons on board.

AMC2 NCO.IDE.B.135 Survival equipment

ADDITIONAL SURVIVAL EQUIPMENT

- (a) The following additional survival equipment should be carried when required:
 - (1) 500 ml of water for each four, or fraction of four, persons on board;
 - (2) one knife;
 - (3) first-aid equipment; and
 - (4) one set of air/ground codes.
- (b) If any item of equipment contained in the above list is already carried on board the balloon in accordance with another requirement, there is no need for this to be duplicated.

GM1 NCO.IDE.B.135 Survival equipment

AREAS IN WHICH SEARCH AND RESCUE WOULD BE ESPECIALLY DIFFICULT

The expression 'areas in which search and rescue would be especially difficult' should be interpreted, in this context, as meaning:

- (a) areas so designated by the authority responsible for managing search and rescue; or
- (b) areas that are largely uninhabited and where:
 - (1) the authority referred to in (a) has not published any information to confirm whether search and rescue would be or would not be especially difficult; and
 - (2) the authority referred to in (a) does not, as a matter of policy, designate areas as being especially difficult for search and rescue.

NCO.IDE.B.140 Miscellaneous equipment

- (a) Balloons shall be equipped with protective gloves for each crew member.
- (b) Hot-air balloons shall be equipped with:
 - (1) an alternative source of ignition;
 - (2) a means of measuring and indicating fuel quantity;
 - (3) a fire blanket or fire resistant cover; and
 - (4) a drop line of at least 25 metres (m) in length.
- (c) Gas balloons shall be equipped with:
 - (1) a knife; and
 - (2) a drop line of at least 20 m in length made of natural fibre or electrostatic conductive material.

AMC1 NCO.IDE.B.140(b)(3) Miscellaneous equipment**FIRE BLANKET**

A fire blanket should comply with EN 1869 or equivalent. The size should be at least 1.5 m x 2 m. Smaller sizes are not recommended as they cannot sufficiently cover the source of developing propane fire.

AMC1 NCO.IDE.B.140 (c)(1) Miscellaneous equipment**KNIFE**

The knife, hook knife or equivalent, should be capable of cutting any control line or handling rope that is accessible to the pilot-in-command or a crew member from the basket.

NCO.IDE.B.145 Radio communication equipment

- (a) Where required by the airspace being flown, balloons shall be equipped with radio communication equipment capable of conducting two-way communication with those aeronautical stations or those frequencies to meet airspace requirements.
- (b) Radio communication equipment, if required by (a), shall provide for communication on the aeronautical emergency frequency 121,5 MHz.

GM1 NCO.IDE.B.145 Radio communication equipment**APPLICABLE AIRSPACE REQUIREMENTS**

For balloons being operated under European air traffic control, the applicable airspace requirements include the Single European Sky legislation.

NCO.IDE.B.150 Transponder

When required by the airspace being flown, balloons shall be equipped with a secondary surveillance radar (SSR) transponder with all the required capabilities.

AMC1 NCO.IDE.B.150 Transponder

GENERAL

- (a) The secondary surveillance radar (SSR) transponders of balloons being operated under European air traffic control should comply with any applicable Single European Sky legislation.
- (b) If the Single European Sky legislation is not applicable, the SSR transponders should operate in accordance with the relevant provisions of Volume IV of ICAO Annex 10.

SUBPART E: SPECIFIC REQUIREMENTS

SECTION 1 General

NCO.SPEC.100 Scope

This subpart establishes specific requirements to be followed by a pilot-in-command conducting non-commercial specialised operations with other-than complex motor-powered aircraft.

AMC1 NCO.SPEC.100 Scope

CRITERIA

The pilot-in-command should consider the following criteria to determine whether an activity falls within the scope of specialised operations:

- (a) the aircraft is flown close to the surface to fulfil the mission;
- (b) abnormal manoeuvres are performed;
- (c) special equipment is necessary to fulfil the mission and which affects the manoeuvrability of the aircraft;
- (d) substances are released from the aircraft during the flight where these substances are either harmful or affect the manoeuvrability of the aircraft;
- (e) external loads or goods are lifted or towed; or
- (f) persons enter or leave the aircraft during flight.

GM1 NCO.SPEC.100 Scope

LIST OF SPECIALISED OPERATIONS

- (a) Specialised operations include the following activities:
 - (1) helicopter external loads operations;
 - (2) helicopter survey operations;
 - (3) human external cargo operations;
 - (4) parachute operations and skydiving;
 - (5) agricultural flights;
 - (6) aerial photography flights;
 - (7) glider towing;
 - (8) aerial advertising flights;
 - (9) calibration flights;
 - (10) construction work flights, including stringing power line operations, clearing saw operations;

- (11) oil spill work;
 - (12) avalanche mining operations;
 - (13) survey operations, including aerial mapping operations, pollution control activity;
 - (14) news media flights, television and movie flights;
 - (15) special events flights, including such as flying display, competition flights;
 - (16) aerobatic flights;
 - (17) animal herding and rescue flights and veterinary dropping flights;
 - (18) maritime funeral operations;
 - (19) scientific research flights (other than those under Annex II of Regulation 216/2008); and
 - (20) cloud seeding.
- (b) For other operations, the pilot-in-command can apply the criteria specified in AMC1 NCO.SPEC.100 to determine whether an activity falls within the scope of specialised operations.

NCO.SPEC.105 Checklist

- (a) Before commencing a specialised operation, the pilot-in-command shall conduct a risk assessment, assessing the complexity of the activity to determine the hazards and associated risks inherent in the operation and establish mitigating measures.
- (b) A specialised operation shall be performed in accordance with a checklist. Based on the risk assessment, the pilot-in-command shall establish such checklist appropriate to the specialised activity and aircraft used, taking account of any section of this subpart.
- (c) The checklist that is relevant to the duties of the pilot-in-command, crew members and task specialists shall be readily accessible on each flight.
- (d) The checklist shall be regularly reviewed and updated, as appropriate.

GM1 NCO.SPEC.105 Checklist

DEVELOPMENT OF CHECKLISTS

For developing the checklist, the pilot-in-command should duly take into account at least the following items:

- (a) nature and complexity of the activity:
 - (1) the nature of the flight and the risk exposure, e.g. low height;
 - (2) the complexity of the activity taking into account the necessary pilot skills and level of experience, ground support, safety and individual protective equipment;
 - (3) the operational environment and geographical area, e.g., congested hostile environment, mountainous areas, sea areas, or desert areas;
 - (4) the result of the risk assessment and evaluation;
- (b) aircraft and equipment:
 - (1) the category of aircraft to be used for the activity should be indicated, e.g. helicopter/aeroplane, single/multi-engined;
 - (2) all equipment required for the activity should be listed;
- (c) crew members:
 - (1) crew composition;
 - (2) minimum crew experience and training provisions; and
 - (3) recency provisions;
- (d) task specialists:
 - (1) description of the task specialists' function(s)
 - (2) minimum crew experience and training provisions; and
 - (3) recency provisions;
 - (4) briefing;
- (e) aircraft performance:

this chapter should detail the specific performance requirements to be applied, in order to ensure an adequate power margin;
- (f) normal procedures and emergency procedures:

- (1) operating procedures for the flight crew, including the coordination with task specialists;
- (2) ground procedures for the task specialists;
- (g) ground equipment:
this chapter should detail the nature, number and location of ground equipment required for the activity;
- (h) records:
it should be determined which records specific to these flight(s) are to be kept, such as task details, aircraft registration, pilot-in-command, flight times, weather and any remarks, including a record of occurrences affecting flight safety or the safety of persons or property on the ground.

GM2 NCO.SPEC.105 Checklists

TEMPLATE FORMS

The following templates are examples, which could be used for developing checklist.

- (a) Template Form A — Risk assessment (RA)

Date: RA of Responsible:
Purpose:
Type of operation and brief description:
Participants, working group:
Preconditions, assumptions and simplifications:
Data used:
Description of the analysis method:
External context:
<ul style="list-style-type: none"> • Regulatory requirements • Approvals • Environmental conditions (visibility, wind, turbulence, contrast, light, elevation, etc.; unless evident from the checklists) • Stakeholders and their potential interest
Internal context:
<ul style="list-style-type: none"> • Type(s) of aircraft • Personnel and qualifications • Combination/similarity with other operations/SOPs • Other RA used/considered/plugged in

Existing barriers and emergency preparedness:
Monitoring and follow up:
Description of the risk:
Risk evaluation:
Conclusions:

(b) Template Form B – Hazard identification (HI)

Date: HI of Responsible:

Phase of operation	Haz ref	Hazard / accidental event	Cause / threat	Current Treatment Measures (TM)	Further treatment required	TM ref	Comment

Haz ref: A unique number for hazards, e.g., for use in a database

TM ref: A unique number for the treatment method

(c) Template Form C – Mitigating measures

Date:..... RA of Responsible:.....

Phase of operation	Haz ref	Hazard /accidental event	Current Treatment Measures (TM)/controls	TM ref	L	C	Further treatment required

Haz ref: A unique number for hazards, e.g., for use in a database

TM ref: A unique number for the treatment method

L: Likelihood (probability)

C: Consequence

(d) Template register A — Risk register

Ref	Operation / Procedure	Ref	Generic hazard	Ref	Accidental event	Treatment / control	L	C	Monitoring

L: Likelihood (probability)

C: Consequence

NCO.SPEC.110 Pilot-in-command responsibilities and authority

Whenever crew members or task specialists are involved in the operation, the pilot-in-command shall

- (a) ensure compliance of crew members and task specialists with NCO.SPEC.115 and NCO.SPEC.120;
- (b) not commence a flight if any crew member or task specialist is incapacitated from performing duties by any cause such as injury, sickness, fatigue or the effects of any psychoactive substance;
- (c) not continue a flight beyond the nearest weather-permissible aerodrome or operating site when any crew member or task specialist's capacity to perform duties is significantly reduced from causes such as fatigue, sickness or lack of oxygen;
- (d) ensure that crew members and task specialists comply with the laws, regulations and procedures of those States where operations are conducted;
- (e) ensure that all crew members and task specialists are able to communicate with each other in a common language; and
- (f) ensure that task specialists and crew members use supplemental oxygen continuously whenever he/she determines that at the altitude of the intended flight the lack of oxygen might result in impairment of the faculties of crew members or harmfully affect task specialists. If the pilot-in-command cannot determine how the lack of oxygen might affect the occupants on board, he/she shall ensure that task specialists and crew members use supplemental oxygen continuously whenever the cabin altitude exceeds 10 000 ft for a period of more than 30 minutes and whenever the cabin altitude exceeds 13 000 ft.

AMC1 NCO.SPEC.110(f) Pilot-in-command responsibilities and authority**DETERMINATION OF SUPPLEMENTAL OXYGEN NEED**

When determining the need for supplemental oxygen carriage and use, the pilot-in-command should:

- (a) in the preflight phase:
 - (1) be aware of hypoxia conditions and associated risks;
 - (2) consider the following objective conditions for the intended flight:
 - (i) altitude;
 - (ii) duration of the flight; and
 - (iii) any other relevant operational conditions;
 - (3) consider individual conditions of flight crew members and task specialists in relation to:
 - (i) altitude of the place of residence;
 - (ii) smoking;
 - (iii) experience in flights at high altitudes;
 - (iv) actual medical conditions and medications;
 - (v) age;
 - (vi) disabilities; and
 - (vii) any other relevant factor that may be detected, or reported by the person; and
 - (4) when relevant, ensure that all flight crew members and task specialists are briefed on hypoxia conditions and symptoms, as well as on the usage of supplemental oxygen equipment.

- (b) during flight:
 - (1) monitor for early symptoms of hypoxia conditions; and
 - (2) if detecting early symptoms of hypoxia conditions:
 - (i) consider to return to a safe altitude, and
 - (ii) ensure that supplemental oxygen is used, if available.

GM1 NCO.SPEC.110(f) Pilot-in-command responsibilities and authority

DETERMINATION OF SUPPLEMENTAL OXYGEN NEED

- (a) The responsibility of the pilot-in-command for safety of all persons on board, as required by NCO.GEN.105(a)(1), includes the determination of need for supplemental oxygen use.
- (b) The altitudes above which NCO.SPEC.110(f) requires oxygen to be available and used are applicable to those cases when the pilot-in-command cannot determine the need for supplemental oxygen. However, if the pilot-in-command is able to make this determination, he/she may elect in the interest of safety to require oxygen also for operations at or below such altitudes.
- (c) The pilot-in-command should be aware that flying below altitudes mentioned in NCO.SPEC.110(f) does not provide absolute protection against hypoxia symptoms, should individual conditions and aptitudes be prevalent.

GM2 NCO.SPEC.110(f) Pilot-in-command responsibilities and authority

DETERMINATION OF OXYGEN NEED — BEFORE FLIGHT

Detailed information and guidance on hypoxia conditions and symptoms, content of the briefing on hypoxia and assessment of individual conditions may be found in the EASA leaflet 'Hypoxia'.

DETERMINATION OF OXYGEN NEED — IN FLIGHT

Several methods for monitoring hypoxia early symptoms may be used and some methods may be aided by personal equipment, such as finger-mounted pulse oximeters. Detailed information and guidance on entering hypoxia conditions, on hypoxia symptoms early detection, and on use of personal equipment such as finger-mounted pulse oximeters or equivalent may be found in the EASA leaflet 'Hypoxia'.

NCO.SPEC.115 Crew responsibilities

- (a) The crew member shall be responsible for the proper execution of his/her duties. Crew duties shall be specified in the checklist.
- (b) Except for balloons, during critical phases of flight or whenever deemed necessary by the pilot-in-command in the interest of safety, the crew member shall be restrained at his/her assigned station unless otherwise specified in the checklist.
- (c) During flight, the flight crew member shall keep his/her safety belt fastened while at his/her station.
- (d) During flight, at least one qualified flight crew member shall remain at the controls of the aircraft at all times.
- (e) The crew member shall not undertake duties on an aircraft:
 - (1) if he/she knows or suspects that he/she is suffering from fatigue as referred to in 7.f. of Annex IV to Regulation (EC) No 216/2008 or feels otherwise unfit to perform his/her duties; or
 - (2) when under the influence of psychoactive substances or alcohol or for other reasons as referred to in 7.g of Annex IV to Regulation (EC) No 216/2008.
- (f) The crew member who undertakes duties for more than one operator shall:
 - (1) maintain his/her individual records regarding flight and duty times and rest periods as referred to in Annex III (Part-ORO), Subpart FTL to Regulation (EU) No 965/2012, if applicable; and
 - (2) provide each operator with the data needed to schedule activities in accordance with the applicable FTL requirements.
- (g) The crew member shall report to the pilot-in-command:
 - (1) any fault, failure, malfunction or defect, which he/she believes may affect the airworthiness or safe operation of the aircraft, including emergency systems; and
 - (2) any incident that was endangering, or could endanger, the safety of the operation.

NCO.SPEC.120 Task specialists responsibilities

- (a) The task specialist shall be responsible for the proper execution of his/her duties. Task specialists' duties shall be specified in the checklist.
- (b) Except for balloons, during critical phases of flight or whenever deemed necessary by the pilot-in-command in the interest of safety, the task specialist shall be restrained at his/her assigned station unless otherwise specified in the checklist.
- (c) The task specialist shall ensure that he/she is restrained when carrying out specialised tasks with external doors opened or removed.
- (d) The task specialist shall report to the pilot-in-command:
 - (1) any fault, failure, malfunction or defect, which he/she believes may affect the airworthiness or safe operation of the aircraft, including emergency systems; and
 - (2) any incident that was endangering, or could endanger, the safety of the operation.

NCO.SPEC.125 Safety briefing

- (a) Before take-off, the pilot-in-command shall brief task specialists on:
 - (1) emergency equipment and procedures;
 - (2) operational procedures associated with the specialised task before each flight or series of flights.
- (b) The briefing referred to in (a)(2) may not be required if task specialists have been instructed on the operational procedures before the start of the operating season in that calendar year.

AMC1 NCO.SPEC.125 Safety briefing

TASK SPECIALISTS

- (a) Safety briefings should ensure that task specialists are familiar with all aspects of the operation, including their responsibilities.
- (b) Such briefings should include, as appropriate:
 - (1) behaviour on the ground and in-flight, including emergency procedures;
 - (2) procedures for boarding and disembarking;
 - (3) procedures for loading and unloading the aircraft;
 - (4) use of doors in normal and emergency operations;
 - (5) use of communication equipment and hand signals;
 - (6) precautions in case of a landing on sloping ground; and
 - (7) in addition to the items listed from (b)(1) to (b)(6) before take-off:
 - (i) location of emergency exits;
 - (ii) restrictions regarding smoking;
 - (iii) restrictions regarding the use of portable electronic equipment; and
 - (iv) stowage of tools and hand baggage.
- (c) Briefings may be given as a verbal presentation or by issuing the appropriate procedures and instructions in written form. Before commencement of the flight, their understanding should be confirmed.

NCO.SPEC.130 Minimum obstacle clearance altitudes — IFR flights

The pilot-in-command shall establish minimum flight altitudes for each flight providing the required terrain clearance for all route segments to be flown in IFR. The minimum flight altitudes shall not be lower than those published by the State overflown.

NCO.SPEC.135 Fuel and oil supply — aeroplanes

NCO.OP.125(a)(1)(i) does not apply to sailplane-towing, flying display, aerobatic flights or competition flights.

NCO.SPEC.140 Fuel and oil supply — helicopters

Notwithstanding NCO.OP.126(a)(1), the pilot-in-command of a helicopter may only commence a VFR flight by day remaining within 25 NM of the aerodrome/operating site of departure with reserve fuel of not less than 10 minutes at best-range-speed.

NCO.SPEC.145 Simulated situations in flight

Unless a task specialist is on-board the aircraft for training, the pilot-in-command shall, when carrying task specialists, not simulate:

- (a) situations that require the application of abnormal or emergency procedures; or
- (b) flight in instrument meteorological conditions (IMC).

NCO.SPEC.150 Ground proximity detection

If installed, the ground proximity warning system may be disabled during those specialised tasks, which by their nature require the aircraft to be operated within a distance from the ground below that which would trigger the ground proximity warning system.

NCO.SPEC.155 Airborne collision avoidance system (ACAS II)

Notwithstanding NCO.OP.200, the ACAS II may be disabled during those specialised tasks, which by their nature require the aircraft to be operated within a distance from each other below that which would trigger the ACAS.

NCO.SPEC.160 Release of dangerous goods

The pilot-in-command shall not operate an aircraft over congested areas of cities, towns or settlements or over an open-air assembly of persons when releasing dangerous goods.

NCO.SPEC.165 Carriage and use of weapons

- (a) The pilot-in-command shall ensure that, when weapons are carried on a flight for the purpose of a specialised task, these are secured when not in use.
- (b) The task specialist using the weapon shall take all necessary measures to prevent the aircraft and persons on board or on the ground from being endangered.

NCO.SPEC.170 Performance and operating criteria — aeroplanes

When operating an aeroplane at a height of less than 150 m (500 ft) above a non-congested area, for operations of aeroplanes that are not able to sustain level flight in the event of a critical engine failure, the pilot-in-command shall have:

- (a) established operational procedures to minimise the consequences of an engine failure; and
- (b) briefed all crew members and task specialists on board on the procedures to be carried out in the event of a forced landing.

NCO.SPEC.175 Performance and operating criteria — helicopters

- (a) The pilot-in-command may operate an aircraft over congested areas provided that:
 - (1) the helicopter is certified in category A or B; and
 - (2) safety measures are established to prevent undue hazard to persons or property on the ground
- (b) The pilot-in-command shall have:
 - (1) established operational procedures to minimise the consequences of an engine failure; and
 - (2) briefed all crew members and task specialists on board on the procedures to be carried out in the event of a forced landing.
- (c) The pilot-in-command shall ensure that the mass at take-off, landing or hover shall not exceed the maximum mass specified for:
 - (1) a hover out of ground effect (HOGE) with all engines operating at the appropriate power rating; or
 - (2) if conditions prevail that a HOGE is not likely to be established, the helicopter mass shall not exceed the maximum mass specified for a hover in ground effect (HIGE) with all engines operating at the appropriate power rating, provided prevailing conditions allow a hover in ground effect at the maximum specified mass.

GM1 NCO.SPEC.175(c) Performance and operating criteria — helicopters

GENERAL

- (a) Even when the surface allows a hover in ground effect (HIGE), the likelihood of, for example, dust or blowing snow may necessitate hover out of ground effect (HOGE) performance.
- (b) Wind conditions on some sites, particularly downdraft in mountainous areas, may require a reduction in the helicopter mass in order to ensure that an out of ground effect hover can be achieved at the operational site in the conditions prevailing.

SECTION 2
Helicopter external sling load operations (HESLO)

NCO.SPEC.HESLO.100 Checklist

The checklist for HESLO shall contain:

- (a) normal, abnormal and emergency procedures;
- (b) relevant performance data;
- (c) required equipment;
- (d) any limitations; and
- (e) responsibilities and duties of the pilot-in-command, and, if applicable, crew members and task specialists.

GM1 NCO.SPEC.HESLO.100 Checklist

REFERENCES

The following references to the AMC and GM of Annex VIII (Part-SPO) provide further guidance for the development of checklists.

- (a) AMC1 SPO.SPEC.HESLO.100 provides a generic framework for the development of standard operating procedures (SOP) for HESLO operations. This AMC can be regarded as a good practice example for developing the checklist for HESLO operations.
- (b) GM1 SPO.SPEC.HESLO.100 provides guidance for initial pilot training for HESLO types 1, 2, 3, 4 and 5.

NCO.SPEC.HESLO.105 Specific HESLO equipment

The helicopter shall be equipped with at least:

- (a) one cargo safety mirror or alternative means to see the hook(s)/load; and
- (b) one load meter, unless there is another method of determining the weight of the load.

NCO.SPEC.HESLO.110 Transportation of dangerous goods

The operator transporting dangerous goods to or from unmanned sites or remote locations shall apply to the competent authority for an exemption from the provisions of the Technical Instructions if they intend not to comply with the requirements of those Instructions.

SECTION 3
Human external cargo operations (HEC)

NCO.SPEC.HEC.100 Checklist

The checklist for HEC shall contain:

- (a) normal, abnormal and emergency procedures;
- (b) relevant performance data;
- (c) required equipment;
- (d) any limitations; and
- (e) responsibilities and duties of the pilot-in-command, and, if applicable, crew members and task specialists.

GM1 NCO.SPEC.HEC.100 Checklist

REFERENCES

AMC1 SPO.SPEC.HEC.100 of Annex VIII (Part-SPO) provides a generic framework for the development of SOP for HEC operations. This AMC can be regarded as a good practice example for developing the checklist for HEC operations.

NCO.SPEC.HEC.105 Specific HEC equipment

- (a) The helicopter shall be equipped with:
 - (1) hoist operations equipment or cargo hook;
 - (2) one cargo safety mirror or alternative means to see the hook; and
 - (3) one load meter, unless there is another method of determining the weight of the load.
- (b) The installation of all hoist and cargo hook equipment and any subsequent modifications shall have an airworthiness approval appropriate to the intended function.

SECTION 4
Parachute operations (PAR)

NCO.SPEC.PAR.100 Checklist

The checklist for PAR shall contain:

- (a) normal, abnormal and emergency procedures;
- (b) relevant performance data;
- (c) required equipment;
- (d) any limitations; and
- (e) responsibilities and duties of the pilot-in-command, and, if applicable, crew members and task specialists.

NCO.SPEC.PAR.105 Carriage of crew members and task specialists

The requirement laid down in NCO.SPEC.120(c) shall not be applicable for task specialists performing parachute jumping.

NCO.SPEC.PAR.110 Seats

Notwithstanding NCO.IDE.A.140(a)(1) and NCO.IDE.H.140(a)(1), the floor of the aircraft may be used as a seat, provided means are available for the task specialist to hold or strap on.

NCO.SPEC.PAR.115 Supplemental oxygen

Notwithstanding NCO.SPEC.110(f), the requirement to use supplemental oxygen shall not be applicable for crew members other than the pilot-in-command and for task specialists carrying out duties essential to the specialised task, whenever the cabin altitude:

- (a) exceeds 13 000 ft, for a period of not more than 6 minutes; or
- (b) exceeds 15 000 ft, for a period of not more 3 minutes.

NCO.SPEC.PAR.120 Release of dangerous goods

Notwithstanding NCO.SPEC.160, parachutists may exit the aircraft for the purpose of parachute display over congested areas of cities, towns or settlements or over an open-air assembly of persons whilst carrying smoke train devices, provided these are manufactured for this purpose.

SECTION 5
Aerobatic flights (ABF)

NCO.SPEC.ABF.100 Checklist

The checklist for ABF shall contain:

- (a) normal, abnormal and emergency procedures;
- (b) relevant performance data;
- (c) required equipment;
- (d) any limitations; and
- (e) responsibilities and duties of the pilot-in-command, and, if applicable, crew members and task specialists.

NCO.SPEC.ABF.105 Documents and information

The following documents and information listed in NCO.GEN.135(a) need not be carried during aerobatic flights:

- (a) details of the filed ATS flight plan, if applicable;
- (b) current and suitable aeronautical charts for the route/area of the proposed flight and all routes along which it is reasonable to expect that the flight may be diverted; and
- (c) procedures and visual signals information for use by intercepting and intercepted aircraft.

NCO.SPEC.ABF.110 Equipment

The following equipment requirements need not be applicable to aerobatic flights:

- (a) first-aids kit as laid down in NCO.IDE.A.145 and NCO.IDE.H.145;
- (b) hand-fire extinguishers as laid down in NCO.IDE.A.160 and NCO.IDE.H.180; and
- (c) emergency locator transmitters or personal locator beacons as laid down in NCO.IDE.A.170 and NCO.IDE.H.170.

ANNEX VIII

Specialised Operations

[PART-SPO]

SPO.GEN.005 Scope

- (a) This Annex applies to any specialised operation where the aircraft is used for specialised activities such as agriculture, construction, photography, surveying, observation and patrol, aerial advertisement.
- (b) Notwithstanding (a), non-commercial specialised operations with other-than complex motor-powered aircraft shall comply with Annex VII (Part-NCO).
- (c) Notwithstanding point (a), the following operations with other-than complex motor-powered aircraft may be conducted in accordance with Annex VII (Part-NCO):
 - (1) competition flights or flying displays, on the condition that the remuneration or any valuable consideration given for such flights is limited to recovery of direct costs and a proportionate contribution to annual costs, as well as prizes of no more than a value specified by the competent authority.
 - (2) parachute dropping, sailplane towing or aerobatic flights performed either by a training organisation having its principal place of business in a Member State and approved in accordance with Regulation (EU) No 1178/2011, or by an organisation created with the aim of promoting aerial sport or leisure aviation, on the condition that the aircraft is operated by the organisation on the basis of ownership or dry lease, that the flight does not generate profits distributed outside of the organisation, and that whenever non-members of the organisation are involved, such flights represent only a marginal activity of the organisation.

AMC1 SPO.GEN.005 Scope

CRITERIA

The operators should consider the following criteria to determine whether an activity falls within the scope of specialised operations:

- (a) the aircraft is flown close to the surface to fulfil the mission;
- (b) abnormal manoeuvres are performed;
- (c) special equipment is necessary to fulfil the mission and which affects the manoeuvrability of the aircraft;
- (d) substances are released from the aircraft during the flight where these substances are either harmful or affect the manoeuvrability of the aircraft;
- (e) external loads or goods are lifted or towed; or
- (f) persons enter or leave the aircraft during flight.

GM1 SPO.GEN.005 Scope

LIST OF SPECIALISED OPERATIONS

- (a) Specialised operations include the following activities:
- (1) helicopter external loads operations;
 - (2) helicopter survey operations;
 - (3) human external cargo operations;
 - (4) parachute operations and skydiving;
 - (5) agricultural flights;
 - (6) aerial photography flights;
 - (7) glider towing;
 - (8) aerial advertising flights;
 - (9) calibration flights;
 - (10) construction work flights, including stringing power line operations, clearing saw operations;
 - (11) oil spill work;
 - (12) avalanche mining operations;
 - (13) survey operations, including aerial mapping operations, pollution control activity;
 - (14) news media flights, television and movie flights;
 - (15) special events flights, including such as flying display and competition flights;
 - (16) aerobatic flights;
 - (17) animal herding, animal rescue flights and veterinary dropping flights;
 - (18) maritime funeral operations;
 - (19) scientific research flights (other than those under Annex II to Regulation (EC) No 216/2008);
 - (20) cloud seeding; and
 - (21) sensational flights: flights involving extreme aerobatic manoeuvres carried out for the purpose of allowing the persons on board to experience zero gravity, high G-forces or similar sensations.
- (b) For other operations, the operator can apply the criteria specified in AMC1 SPO.GEN.005 to determine whether an activity falls within the scope of specialised operations.

SUBPART A: GENERAL REQUIREMENTS

SPO.GEN.100 Competent authority

The competent authority shall be the authority designated by the Member State in which the operator has its principal place of business or is residing.

SPO.GEN.101 Means of compliance

Alternative means of compliance to those adopted by the Agency may be used by an operator to establish compliance with Regulation (EC) No 216/2008 and its Implementing Rules.

SPO.GEN.102 Touring motor gliders, -powered sailplanes and mixed balloons

- (a) Touring motor gliders shall be operated following the requirements for:
 - (1) aeroplanes when they are power-driven by an engine; and
 - (2) sailplanes when operated without using an engine.
- (b) Touring motor gliders shall be equipped in compliance with the requirements applicable to aeroplanes unless otherwise specified in Subpart D.
- (c) Powered sailplanes, excluding touring motor gliders, shall be operated and equipped in compliance with the requirements applicable to sailplanes.
- (d) Mixed balloons shall be operated in accordance with the requirements for hot-air balloons.

SPO.GEN.105 Crew responsibilities

- (a) The crew member shall be responsible for the proper execution of his/her duties. Crew duties shall be specified in the standard operating procedures (SOP) and, where appropriate, in the operations manual.
- (b) Except for balloons, during critical phases of flight or whenever deemed necessary by the pilot-in-command in the interest of safety, the crew member shall be restrained at his/her assigned station unless otherwise specified in the SOP.
- (c) During flight, the flight crew member shall keep his/her safety belt fastened while at his/her station.
- (d) During flight, at least one qualified flight crew member shall remain at the controls of the aircraft at all times.
- (e) The crew member shall not undertake duties on an aircraft:
 - (1) if he/she knows or suspects that he/she is suffering from fatigue as referred to in 7.f. of Annex IV to Regulation (EC) No 216/2008 or feels otherwise unfit to perform his/her duties; or
 - (2) when under the influence of psychoactive substances or alcohol or for other reasons as referred to in 7.g. of Annex IV to Regulation (EC) No 216/2008.
- (f) The crew member who undertakes duties for more than one operator shall:

- (1) maintain his/her individual records regarding flight and duty times and rest periods as referred to in Annex III (Part-ORO), Subpart FTL to Regulation (EU) No 965/2012, if applicable; and
 - (2) provide each operator with the data needed to schedule activities in accordance with the applicable FTL requirements.
- (g) The crew member shall report to the pilot-in-command:
- (1) any fault, failure, malfunction or defect, which he/she believes may affect the airworthiness or safe operation of the aircraft, including emergency systems; and
 - (2) any incident that was endangering, or could endanger, the safety of the operation.

GM1 SPO.GEN.105(e)(2) Crew member responsibilities

GENERAL

In accordance with 7.g. of Annex IV to Regulation (EC) No 216/2008¹ (Essential Requirements for air operations), a crew member must not perform duties on board an aircraft when under the influence of psychoactive substances or alcohol or when unfit due to injury, fatigue, medication, sickness or other similar causes. This should be understood as including the following:

- (a) effects of deep water diving and blood donation, and allowing for a certain time period between these activities and returning to flying; and
- (b) without prejudice to more restrictive national regulations, the consumption of alcohol while on duty or less than 8 hours prior to the commencement of duties, and commencing a flight duty period with a blood alcohol level in excess of 0.2 per thousand.

¹ Regulation (EC) No 216/2008 of the European Parliament and of the Council of 20 February 2008 on common rules in the field of civil aviation and establishing a European Aviation Safety Agency, and repealing Council Directive 91/670/EEC, Regulation (EC) No 1592/2002 and Directive 2004/36/EC (OJ L 79, 19.3.2008, p. 1). Regulation as last amended by Commission Regulation (EU) No 6/2013 of 8 January 2013 (OJ L 4, 9.1.2013, p. 34).

SPO.GEN.106 Task specialists responsibilities

- (a) The task specialist shall be responsible for the proper execution of his/her duties. Task specialists' duties shall be specified in the SOP.
- (b) Except for balloons, during critical phases of flight or whenever deemed necessary by the pilot-in-command in the interest of safety, the task specialist shall be restrained at his/her assigned station unless otherwise specified in the SOP.
- (c) The task specialist shall ensure that he/she is restrained when carrying out specialised tasks with external doors opened or removed.
- (d) The task specialist shall report to the pilot-in-command:
 - (1) any fault, failure, malfunction or defect, which he/she believes may affect the airworthiness or safe operation of the aircraft, including emergency systems; and
 - (2) any incident that was endangering, or could endanger, the safety of the operation.

SPO.GEN.107 Pilot-in-command responsibilities and authority

- (a) The pilot-in-command shall be responsible for:
 - (1) the safety of the aircraft and of all crew members, task specialists and cargo on board during aircraft operations;
 - (2) the initiation, continuation, termination or diversion of a flight in the interest of safety;
 - (3) ensuring that all operational procedures and checklists are complied with in accordance with the appropriate manual;
 - (4) only commencing a flight if he/she is satisfied that all operational limitations referred to in 2.a.3 of Annex IV to Regulation (EC) No 216/2008 are complied with, as follows:
 - (i) the aircraft is airworthy;
 - (ii) the aircraft is duly registered;
 - (iii) instruments and equipment required for the execution of that flight are installed in the aircraft and are operative, unless operation with inoperative equipment is permitted by the minimum equipment list (MEL) or equivalent document, if applicable, as required in SPO.IDE.A.105, SPO.IDE.H.105, SPO.IDE.S.105 or SPO.IDE.B.105;
 - (iv) the mass of the aircraft and, except in the case of balloons, the centre of gravity location are such that the flight can be conducted within limits prescribed in the airworthiness documentation;
 - (v) all equipment and baggage is properly loaded and secured;
 - (vi) the aircraft operating limitations as specified in the aircraft flight manual (AFM) will not be exceeded at any time during the flight; and
 - (vii) any navigational database required for PBN is suitable and current;
 - (5) not commencing a flight if he/she, or any other crew member or task specialist is incapacitated from performing duties by any cause such as injury, sickness, fatigue or the effects of any psychoactive substance;

-
- (6) not continuing a flight beyond the nearest weather-permissible aerodrome or operating site when his/her or any other crew member or task specialist's capacity to perform duties is significantly reduced from causes such as fatigue, sickness or lack of oxygen;
 - (7) deciding on acceptance of the aircraft with unserviceabilities in accordance with the configuration deviation list (CDL) or MEL, if applicable;
 - (8) recording utilisation data and all known or suspected defects in the aircraft at the termination of the flight, or series of flights, in the aircraft technical log or journey log for the aircraft; and
 - (9) ensuring that:
 - (i) flight recorders are not disabled or switched off during flight;
 - (ii) in the event of an occurrence other than an accident or a serious incident that shall be reported according to ORO.GEN.160(a), flight recorders' recordings are not intentionally erased; and
 - (iii) in the event of an accident or a serious incident, or if preservation of recordings of flight recorders is directed by the investigating authority:
 - (A) flight recorders' recordings are not intentionally erased;
 - (B) flight recorders are deactivated immediately after the flight is completed; and
 - (C) precautionary measures to preserve the recordings of flight recorders are taken before leaving the flight crew compartment.
- (b) The pilot-in-command shall have the authority to refuse carriage of or disembark any person or cargo that may represent a potential hazard to the safety of the aircraft or its occupants.
 - (c) The pilot-in-command shall, as soon as possible, report to the appropriate air traffic services (ATS) unit any hazardous weather or flight conditions encountered that are likely to affect the safety of other aircraft.
 - (d) Notwithstanding the provision of (a)(6), in a multi-crew operation the pilot-in-command may continue a flight beyond the nearest weather-permissible aerodrome when adequate mitigating procedures are in place.
 - (e) The pilot-in-command shall, in an emergency situation that requires immediate decision and action, take any action he/she considers necessary under the circumstances in accordance with 7.d. of Annex IV to Regulation (EC) No 216/2008. In such cases he/she may deviate from rules, operational procedures and methods in the interest of safety.
 - (f) The pilot-in-command shall submit a report of an act of unlawful interference without delay to the competent authority and shall inform the designated local authority.
 - (g) The pilot-in-command shall notify the nearest appropriate authority by the quickest available means of any accident involving the aircraft that results in serious injury or death of any person or substantial damage to the aircraft or property.

AMC1 SPO.GEN.107 Pilot-in-command responsibilities and authority

FLIGHT PREPARATION FOR PBN OPERATIONS

- (a) The flight crew should ensure that RNAV 1, RNAV 2, RNP 1 RNP 2, and RNP APCH routes or procedures to be used for the intended flight, including for any alternate aerodromes, are selectable from the navigation database and are not prohibited by NOTAM.
- (b) The flight crew should take account of any NOTAMs or operator briefing material that could adversely affect the aircraft system operation along its flight plan including any alternate aerodromes.
- (c) When PBN relies on GNSS systems for which RAIM is required for integrity, its availability should be verified during the preflight planning. In the event of a predicted continuous loss of fault detection of more than five minutes, the flight planning should be revised to reflect the lack of full PBN capability for that period.
- (d) For RNP 4 operations with only GNSS sensors, a fault detection and exclusion (FDE) check should be performed. The maximum allowable time for which FDE capability is projected to be unavailable on any one event is 25 minutes. If predictions indicate that the maximum allowable FDE outage will be exceeded, the operation should be rescheduled to a time when FDE is available.
- (e) For RNAV 10 operations, the flight crew should take account of the RNAV 10 time limit declared for the inertial system, if applicable, considering also the effect of weather conditions that could affect flight duration in RNAV 10 airspace. Where an extension to the time limit is permitted, the flight crew will need to ensure that en route that radio facilities are serviceable before departure, and to apply radio updates in accordance with any AFM limitation.

AMC2 SPO.GEN.107 Pilot-in-command responsibilities and authority

DATABASE SUITABILITY

- (a) The flight crew should check that any navigational database required for PBN operations includes the routes and procedures required for the flight.

DATABASE CURRENCY

- (b) The database validity (current AIRAC cycle) should be checked before the flight.
- (c) Navigation databases should be current for the duration of the flight. If the AIRAC cycle is due to change during flight, the flight crew should follow procedures established by the operator to ensure the accuracy of navigation data, including the suitability of navigation facilities used to define the routes and procedures for the flight.
- (d) An expired database may only be used if the following conditions are satisfied:
 - (1) the operator has confirmed that the parts of the database which are intended to be used during the flight and any contingencies that are reasonable to expect are not changed in the current version;
 - (2) any NOTAMs associated with the navigational data are taken into account;
 - (3) maps and charts corresponding to those parts of the flight are current and have not been amended since the last cycle;
 - (4) any MEL limitations are observed; and

- (5) the database has expired by no more than 28 days.

GM1 SPO.GEN.107 Pilot-in-command responsibilities and authority

GENERAL

In accordance with 1.c. of Annex IV to Regulation (EC) No 216/2008 (Essential Requirements for air operations), the pilot-in-command is responsible for the operation and safety of the aircraft and for the safety of all crew members, task specialists and cargo on board. This includes the following:

- (a) the safety of all persons and cargo on board, as soon as he/she arrives on board, until he/she leaves the aircraft at the end of the flight; and
- (b) the operation and safety of the aircraft:
 - (1) for aeroplanes, from the moment it is first ready to move for the purpose of flight until the moment it comes to rest at the end of the flight and the engine(s) used as primary propulsion unit(s) is/are shut down;
 - (2) for helicopters, from the moment the engine(s) are started until the helicopter comes to rest at the end of the flight with the engine(s) shut down and the rotor blades stopped;
 - (3) for sailplanes, from the moment the launch procedure is started until the aircraft comes to rest at the end of the flight; or
 - (4) for balloons, from the moment the inflating of the envelope is started until the envelope is deflated.

GM1 SPO.GEN.107(a)(8) Pilot-in-command responsibilities and authority

RECORDING UTILISATION DATA

Where an aircraft conducts a series of flights of short duration — such as a helicopter doing a series of lifts — and the aircraft is operated by the same pilot-in-command, the utilisation data for the series of flights may be recorded in the aircraft technical log or journey log as a single entry.

GM1 SPO.GEN.107(a)(9) Pilot-in-command responsibilities and authority

IDENTIFICATION OF THE SEVERITY OF AN OCCURRENCE BY THE PILOT-IN-COMMAND

The definitions of an accident and a serious incident as well as examples thereof can be found in Regulation (EU) No 996/2010 of the European Parliament and of the Council.

AMC1 SPO.GEN.107(c) Pilot-in-command responsibilities and authority

REPORTING OF HAZARDOUS FLIGHT CONDITIONS

- (a) These reports should include any detail which may be pertinent to the safety of other aircraft.
- (b) Such reports should be made whenever any of the following conditions are encountered or observed:
 - (1) severe turbulence;
 - (2) severe icing;
 - (3) severe mountain wave;

- (4) thunderstorms, with or without hail, that are obscured, embedded, widespread or in squall lines;
 - (5) heavy dust storm or heavy sandstorm;
 - (6) volcanic ash cloud; and
 - (7) unusual and/or increasing volcanic activity or a volcanic eruption.
- (c) When other meteorological conditions not listed above, e.g. wind shear, are encountered that, in the opinion of the pilot-in-command, may affect the safety or the efficiency of other aircraft operations, the pilot-in-command should advise the appropriate air traffic services (ATS) unit as soon as practicable.

AMC1 SPO.GEN.107(e) Pilot-in-command responsibilities and authority

VIOLATION REPORTING

If required by the State in which the incident occurs, the pilot-in-command should submit a report on any such violation to the appropriate authority of the said State; in that event, the pilot-in-command should also submit a copy of it to the competent authority. Such reports should be submitted as soon as possible and normally within 10 days.

SPO.GEN.108 Pilot-in-command responsibilities and authority — balloons

The pilot-in-command of a balloon shall, in addition to SPO.GEN.107:

- (a) be responsible for the pre-flight briefing of those persons assisting in the inflation and deflation of the envelope;
- (b) ensure that no person is smoking on board or within the direct vicinity of the balloon; and
- (c) ensure that persons assisting in the inflation and deflation of the envelope wear appropriate protective clothing.

GM1 SPO.GEN.108(c) Pilot-in-command responsibilities and authority — balloons**PROTECTIVE CLOTHING**

Protective clothing includes:

- (a) long sleeves and trousers preferably made out of natural fibres;
- (b) stout footwear; and
- (c) gloves.

SPO.GEN.110 Compliance with laws, regulations and procedures

The pilot-in-command, crew members and task specialists shall comply with the laws, regulations and procedures of those States where operations are conducted.

SPO.GEN.115 Common language

The operator shall ensure that all crew members and task specialists are able to communicate with each other in a common language.

SPO.GEN.119 Taxiing of aircraft

The operator shall establish procedures for taxiing of aircraft in order to ensure safe operation and in order to enhance runway safety.

AMC1 SPO.GEN.119 Taxiing of aircraft**PROCEDURES FOR TAXIING**

Procedures for taxiing should include at least the following:

- (a) application of sterile flight deck crew compartment procedures;
- (b) use of standard radio-telephony (RTF) phraseology;
- (c) use of lights;
- (d) measures to enhance the situational awareness of the pilot-in-command. The following list of typical items should be adapted by the operator to take into account its operational environment:
 - (1) the pilot-in-command should have the necessary aerodrome layout charts available;
 - (2) if applicable, the pilot taxiing the aircraft should announce in advance his/her intentions to the pilot monitoring;

-
- (3) if applicable, all taxi clearances should be heard, and should be understood by the pilot-in-command;
 - (4) if applicable, all taxi clearances should be cross-checked against the aerodrome chart and aerodrome surface markings, signs and lights;
 - (5) an aircraft taxiing on the manoeuvring area should stop and hold at all lighted stop bars, and may proceed further when an explicit clearance to enter or cross the runway has been issued by the aerodrome control tower, and when the stop bar lights are switched off;
 - (6) if the pilot-in-command is unsure of his/her position, he/she should stop the aircraft and contact air traffic control;
 - (7) any action, which may disturb the pilot-in-command from the taxi activity, should be avoided or done with the parking brake set.

SPO.GEN.120 Taxiing of aeroplanes

The operator shall ensure that an aeroplane is only taxied on the movement area of an aerodrome if the person at the controls:

- (a) is an appropriately qualified pilot; or
- (b) has been designated by the operator and:
 - (1) is trained to taxi the aeroplane;
 - (2) is trained to use the radio telephone, if radio communications are required;
 - (3) has received instruction in respect of aerodrome layout, routes, signs, marking, lights, air traffic control (ATC) signals and instructions, phraseology and procedures; and
 - (4) is able to conform to the operational standards required for safe aeroplane movement at the aerodrome.

GM1 SPO.GEN.120 Taxiing of aeroplanes

SAFETY-CRITICAL ACTIVITY

- (a) Taxiing should be treated as a safety-critical activity due to the risks related to the movement of the aeroplane and the potential for a catastrophic event on the ground.
- (b) Taxiing is a high-workload phase of flight that requires the full attention of the flight crew.

GM1 SPO.GEN.120(b)(4) Taxiing of aeroplanes

SKILLS AND KNOWLEDGE

The person designated by the operator to taxi an aeroplane should possess the following skills and knowledge:

- (a) positioning of the aeroplane to ensure safety when starting engine;
- (b) getting ATIS reports and taxi clearance, where applicable;
- (c) interpretation of airfield markings/lights/signals/indicators;
- (d) interpretation of marshalling signals, where applicable;
- (e) identification of suitable parking area;
- (f) maintaining lookout and right-of-way rules and complying with ATC or marshalling instructions when applicable;
- (g) avoidance of adverse effect of propeller slipstream or jet wash on other aeroplanes, aerodrome facilities and personnel;
- (h) inspection of taxi path when surface conditions are obscured;
- (i) communication with others when controlling an aeroplane on the ground;
- (j) interpretation of operational instructions;
- (k) reporting of any problem that may occur while taxiing an aeroplane; and
- (l) adapting the taxi speed in accordance with prevailing aerodrome, traffic, surface and weather conditions.

SPO.GEN.125 Rotor engagement

A helicopter rotor shall only be turned under power for the purpose of flight with a qualified pilot at the controls.

GM1 SPO.GEN.125 Rotor engagement

INTENT OF THE RULE

- (a) The following two situations where it is allowed to turn the rotor under power should be distinguished:
 - (1) for the purpose of flight, as described in the implementing rule;
 - (2) for maintenance purposes.
- (b) Rotor engagement for the purpose of flight: it should be noted that the pilot should not leave the control when the rotors are turning. For example, the pilot is not allowed to get out of the aircraft in order to welcome persons and adjust their seat belts with the rotors turning.
- (c) Rotor engagement for the purpose of maintenance: the implementing rule, however, should not prevent ground runs being conducted by qualified personnel other than pilots for maintenance purposes.

The following conditions should be applied:

- (1) The operator should ensure that the qualification of personnel, other than pilots, who are authorised to conduct maintenance runs, is described in the appropriate manual.
- (2) Ground runs should not include taxiing the helicopter.
- (3) There should be no other persons on board.
- (4) Maintenance runs should not include collective increase or auto pilot engagement (risk of ground resonance).

SPO.GEN.130 Portable electronic devices

The operator shall not permit any person to use a portable electronic device (PED) on board an aircraft that could adversely affect the performance of the aircraft's systems and equipment.

GM1 SPO.GEN.130 Portable electronic devices

DEFINITIONS

(a) Definition and categories of PEDs

PEDs are any kind of electronic device, typically but not limited to consumer electronics, brought on board the aircraft by crew members, passengers, or as part of the cargo and that are not included in the approved aircraft configuration. All equipment that is able to consume electrical energy falls under this definition. The electrical energy can be provided from internal sources as batteries (chargeable or non-rechargeable) or the devices may also be connected to specific aircraft power sources.

PEDs include the following two categories:

- (1) Non-intentional transmitters can non-intentionally radiate RF transmissions, sometimes referred to as spurious emissions. This category includes, but is not limited to, calculators, cameras, radio receivers, audio and video players, electronic games and toys; when these devices are not equipped with a transmitting function.
- (2) Intentional transmitters radiate RF transmissions on specific frequencies as part of their intended function. In addition, they may radiate non-intentional transmissions like any PED. The term 'transmitting PED' (T-PED) is used to identify the transmitting capability of the PED. Intentional transmitters are transmitting devices such as RF-based remote control equipment, which may include some toys, two-way radios (sometimes referred to as private mobile radio), mobile phones of any type, satellite phones, computers with mobile phone data connection, wireless local area network (WLAN) or Bluetooth capability. After deactivation of the transmitting capability, e.g. by activating the so-called 'flight mode' or 'flight safety mode', the T-PED remains a PED having non-intentional emissions.

(b) Definition of the switched-off status

Many PEDs are not completely disconnected from the internal power source when switched off. The switching function may leave some remaining functionality e.g. data storage, timer, clock, etc. These devices can be considered switched off when in the deactivated status. The same applies for devices having no transmitting capability and are operated by coin cells without further deactivation capability, e.g. wrist watches.

GM2 SPO.GEN.130 Portable electronic devices

GENERAL

- (a) PEDs can pose a risk of interference with electronically operated aircraft systems. Those systems could range from the electronic engine control, instruments, navigation or communication equipment and autopilots to any other type of avionic equipment on the aircraft. The interference can result in on-board systems malfunctioning or providing misleading information and communication disturbance. These can also lead to an increased workload for the flight crew.

-
- (b) Interference may be caused by transmitters being part of the PED's functionality or by unintentional transmissions from the PED. Due to the likely proximity of the PED to any electronically operated aircraft system and the generally limited shielding found in small aircraft, the risk of interference is to be considered higher than that for larger aircraft with metal airframes.
 - (c) During certification of the aircraft, when qualifying the aircraft functions consideration may only have been made of short-term exposure to a high radiating field, with an acceptable mitigating measure being a return to normal function after removal of the threat. This certification assumption may not be true when operating the transmitting PED on board the aircraft.
 - (d) It has been found that compliance with the electromagnetic compatibility (EMC) Directive 2004/108/EC and related European standards as indicated by the CE marking is not sufficient to exclude the existence of interference. A well-known interference is the demodulation of the transmitted signal from GSM (global system for mobile communications) mobile phones leading to audio disturbances in other systems. Similar interferences are difficult to predict during the PED design and protecting the aircraft's electronic systems against the full range of potential interferences is practically impossible. Therefore, not operating PEDs on-board aircraft is the safest option, especially as effects may not be identified immediately but under the most inconvenient circumstances.
 - (e) Guidance to follow in case of fire caused by PEDs is provided by the International Civil Aviation Organisation, 'Emergency response guidance for aircraft incidents involving dangerous goods', ICAO Doc 9481-AN/928.

SPO.GEN.135 Information on emergency and survival equipment carried

The operator shall, at all times, have available for immediate communication to rescue coordination centres (RCCs) lists containing information on the emergency and survival equipment carried on board.

AMC1 SPO.GEN.135 Information on emergency and survival equipment carried

CONTENT OF INFORMATION

The information, compiled in a list, should include, as applicable:

- (a) the number, colour and type of life rafts and pyrotechnics;
- (b) details of emergency medical supplies and water supplies; and
- (c) the type and frequencies of the emergency portable radio equipment.

SPO.GEN.140 Documents, manuals and information to be carried

- (a) The following documents, manuals and information shall be carried on each flight as originals or copies unless otherwise specified below:
- (1) the AFM, or equivalent document(s);
 - (2) the original certificate of registration;
 - (3) the original certificate of airworthiness (CofA);
 - (4) the noise certificate, if applicable;
 - (5) a copy of the declaration as specified in ORO.DEC.100 and, if applicable, a copy of the authorisation as specified in ORO.SPO.110;
 - (6) the list of specific approvals, if applicable;
 - (7) the aircraft radio licence, if applicable;
 - (8) the third party liability insurance certificate(s);
 - (9) the journey log, or equivalent, for the aircraft;
 - (10) the aircraft technical log, in accordance with Annex I (Part-M) to Regulation (EC) No 2042/2003, if applicable;
 - (11) details of the filed ATS flight plan, if applicable;
 - (12) current and suitable aeronautical charts for the route/area of the proposed flight and all routes along which it is reasonable to expect that the flight may be diverted;
 - (13) procedures and visual signals information for use by intercepting and intercepted aircraft;
 - (14) information concerning search and rescue services for the area of the intended flight;
 - (15) the current parts of the operations manual and/or SOP or AFM that are relevant to the duties of crew members and task specialists, which shall be easily accessible to them;
 - (16) the MEL or CDL, if applicable;
 - (17) appropriate notices to airmen (NOTAMs) and aeronautical information service (AIS) briefing documentation;
 - (18) appropriate meteorological information, if applicable;
 - (19) cargo manifests, if applicable; and
 - (20) any other documentation that may be pertinent to the flight or is required by the States concerned with the flight.
- (b) Notwithstanding (a), the documents and information in (a)(2) to (a)(11) and (a)(14), (a)(17), (a)(18) and (a)(19) may be retained at the aerodrome or operating site on flights:
- (1) intending to take off and land at the same aerodrome or operating site; or
 - (2) remaining within a distance or area determined by the competent authority in accordance with ARO.OPS.210.
- (c) Notwithstanding (a), on flights with balloons or sailplanes, excluding touring motor gliders (TMGs), the documents and information in (a)(1) to (a)(10) and (a)(13) to (a)(19) may be carried in the retrieve vehicle.
- (d) In case of loss or theft of documents specified in (a)(2) to (a)(8), the operation may continue until the flight reaches its destination or a place where replacement documents can be provided.

- (e) The operator shall make available, within a reasonable time of being requested to do so by the competent authority, the documentation required to be carried on board.

AMC1 SPO.GEN.140 Documents, manuals and information to be carried

GENERAL

The documents, manuals and information may be available in a form other than on printed paper. An electronic storage medium is acceptable if accessibility, usability and reliability can be assured.

GM1 SPO.GEN.140(a)(1) Documents, manuals and information to be carried

AFM OR EQUIVALENT DOCUMENT

‘Aircraft flight manual (AFM), or equivalent document’ means the flight manual for the aircraft or other documents containing information required for the operation of the aircraft within the terms of its certificate of airworthiness, unless these data are available in the parts of the operations manual carried on board.

AMC1 SPO.GEN.140(a)(3) Documents, manuals and information to be carried

CERTIFICATE OF AIRWORTHINESS

The certificate of airworthiness should be a normal certificate of airworthiness, a restricted certificate of airworthiness or a permit to fly issued in accordance with the applicable airworthiness requirements.

GM1 SPO.GEN.140(a)(9) Documents, manuals and information to be carried

JOURNEY LOG OR EQUIVALENT

‘Journey log or equivalent’ means in this context that the required information may be recorded in documentation other than a log book, such as the operational flight plan or the aircraft technical log.

AMC1 SPO.GEN.140(a)(12) Documents, manuals and information to be carried

CURRENT AND SUITABLE AERONAUTICAL CHARTS

- (a) The aeronautical charts carried should contain data appropriate to the applicable air traffic regulations, rules of the air, flight altitudes, area/route and nature of the operation. Due consideration should be given to carriage of textual and graphic representations of:
- (1) aeronautical data including, as appropriate for the nature of the operation:
 - (i) airspace structure;
 - (ii) significant points, navigation aids (navaids) and air traffic services (ATS) routes;
 - (iii) navigation and communication frequencies;
 - (iv) prohibited, restricted and danger areas; and
 - (v) sites of other relevant activities that may hazard the flight; and
 - (2) topographical data, including terrain and obstacle data.
- (b) A combination of different charts and textual data may be used to provide adequate and current data.

- (c) The aeronautical data should be appropriate for the current aeronautical information regulation and control (AIRAC) cycle.
- (d) The topographical data should be reasonably recent, having regard to the nature of the planned operation.

AMC1 SPO.GEN.140(a)(13) Documents, manuals and information to be carried

PROCEDURES AND VISUAL SIGNALS FOR USE BY INTERCEPTING AND INTERCEPTED AIRCRAFT

The procedures and the visual signals information for use by intercepting and intercepted aircraft should reflect those contained in the International Civil Aviation Organisation's (ICAO) Annex 2. This may be part of the operations manual.

GM1 SPO.GEN.140(a)(14) Documents, manuals and information to be carried

SEARCH AND RESCUE INFORMATION

This information is usually found in the State's aeronautical information publication.

GM1 SPO.GEN.140(a)(20) Documents, manuals and information to be carried

DOCUMENTS THAT MAY BE PERTINENT TO THE FLIGHT

Any other documents that may be pertinent to the flight or required by the States concerned with the flight may include, for example, forms to comply with reporting requirements.

STATES CONCERNED WITH THE FLIGHT

The States concerned are those of origin, transit, overflight and destination of the flight.

SPO.GEN.145 Handling of flight recorder recordings: preservation, production, protection and use — operations with complex motor-powered aircraft

- (a) Following an accident, a serious incident or an occurrence identified by the investigating authority, the operator of an aircraft shall preserve the original recorded data for a period of 60 days or until otherwise directed by the investigating authority.
 - (b) The operator shall conduct operational checks and evaluations of flight data recorder (FDR) recordings, cockpit voice recorder (CVR) recordings and data link recordings to ensure the continued serviceability of the recorders.
 - (c) The operator shall save the recordings for the period of operating time of the FDR as required by SPO.IDE.A.145 or SPO.IDE.H.145, except that, for the purpose of testing and maintaining the FDR, up to 1 hour of the oldest recorded material at the time of testing may be erased.
 - (d) The operator shall keep and maintain up-to-date documentation that presents the necessary information to convert FDR raw data into parameters expressed in engineering units.
 - (e) The operator shall make available any flight recorder recording that has been preserved, if so determined by the competent authority.
 - (f) Without prejudice to Regulation (EU) No 996/2010 and except for ensuring the CVR serviceability, CVR recordings shall not be disclosed or used unless:
 - (i) a procedure related to the handling of CVR recordings and of their transcript is in place;
 - (ii) all crew members and maintenance personnel concerned have given their prior consent; and
 - (iii) they are used only for maintaining or improving safety.
- When a CVR recording is inspected for ensuring the CVR serviceability, the operator shall ensure the privacy of the CVR recording and the CVR recording shall not be disclosed or used for other purposes than ensuring the CVR serviceability.
- (g) FDR recordings or data link recordings shall only be used for purposes other than for the investigation of an accident or an incident that is subject to mandatory reporting if such records are:
 - (1) used by the operator for airworthiness or maintenance purposes only;
 - (2) de-identified; or
 - (3) disclosed under secure procedures.

AMC1 SPO.GEN.145(a) Handling of flight recorder recordings: preservation, production, protection and use**PRESERVATION OF RECORDED DATA FOR INVESTIGATION**

- (a) The operator should establish procedures to ensure that flight recorder recordings are preserved for the investigating authority.
- (b) These procedures should include:
 - (1) instructions for flight crew members to deactivate the flight recorders immediately after completion of the flight and inform relevant personnel that the recording of the flight recorders should be preserved. These instructions should be readily available on board; and

- (2) instructions to prevent inadvertent reactivation, test, repair or reinstallation of the flight recorders by operator personnel or during maintenance or ground handling activities performed by third parties.

GM1 SPO.GEN.145(a) Handling of flight recorder recordings: preservation, production, protection and use

REMOVAL OF RECORDERS IN CASE OF AN INVESTIGATION

The need for removal of the recorders from the aircraft is determined by the investigating authority with due regard to the seriousness of an occurrence and the circumstances, including the impact on the operation.

AMC1 SPO.GEN.145(b) Handling of flight recorder recordings: preservation, production, protection and use

INSPECTIONS AND CHECKS OF RECORDINGS

Whenever a flight recorder is required to be carried:

- (a) the operator should perform an inspection of the FDR recording and the CVR recording every year unless one or more of the following applies:
 - (1) If the flight recorder records on magnetic wire or uses frequency modulation technology, the time interval between two inspections of the recording should not exceed three months.
 - (2) If the flight recorder is solid-state and the flight recorder system is fitted with continuous monitoring for proper operation, the time interval between two inspections of the recording may be up to two years.
 - (3) In the case of an aircraft equipped with two solid-state flight data and cockpit voice combination recorders, where
 - (i) the flight recorder systems are fitted with continuous monitoring for proper operation, and
 - (ii) the flight recorders share the same flight data acquisition,a comprehensive inspection of the recording needs only to be performed for one flight recorder position. The inspection of the recordings should be performed alternately so that each flight recorder position is inspected at least every four years.
 - (4) Where all of the following conditions are met, the inspection of FDR recording is not needed:
 - (i) the aircraft flight data are collected in the frame of a flight data monitoring (FDM) programme;
 - (ii) the data acquisition of mandatory flight parameters is the same for the FDR and for the recorder used for the FDM programme;
 - (iii) an inspection similar to the inspection of the FDR recording and covering all mandatory flight parameters is conducted on the FDM data at time intervals not exceeding two years; and
 - (iv) the FDR is solid-state and the FDR system is fitted with 'continuous monitoring for proper operation'.

- (b) the operator should perform every five years an inspection of the data link recording.
- (c) when installed, the aural or visual means for preflight checking the flight recorders for proper operation should be used every day. When no such means is available for a flight recorder, the operator should perform an operational check of this flight recorder at time intervals not exceeding seven calendar days of operation.
- (d) the operator should check every five years, or in accordance with the recommendations of the sensor manufacturer, that the parameters dedicated to the FDR and not monitored by other means are being recorded within the calibration tolerances and that there is no discrepancy in the engineering conversion routines for these parameters.

GM1 SPO.GEN.145(b) Handling of flight recorder recordings: preservation, production, protection and use

INSPECTION OF THE FLIGHT RECORDERS RECORDING

- (a) The inspection of the FDR recording usually consists of the following:
 - (1) Making a copy of the complete recording file.
 - (2) Converting the recording to parameters expressed in engineering units in accordance with the documentation required to be held.
 - (3) Examining a whole flight in engineering units to evaluate the validity of all mandatory parameters. This could reveal defects or noise in the measuring and processing chains and indicate necessary maintenance actions. The following should be considered:
 - (i) when applicable, each parameter should be expressed in engineering units and checked for different values of its operational range. For this purpose, some parameters may need to be inspected at different flight phases; and
 - (ii) if the parameter is delivered by a digital data bus and the same data are utilised for the operation of the aircraft, then a reasonableness check may be sufficient; otherwise a correlation check may need to be performed:
 - (A) a reasonableness check is understood in this context as a subjective, qualitative evaluation, requiring technical judgement, of the recordings from a complete flight; and
 - (B) a correlation check is understood in this context as the process of comparing data recorded by the flight data recorder against the corresponding data derived from flight instruments, indicators or the expected values obtained during specified portion(s) of a flight profile or during ground checks that are conducted for that purpose.
 - (4) Retaining the most recent copy of the complete recording file and the corresponding recording inspection report that includes references to the documentation required to be held.
- (b) When performing the CVR recording inspection, precautions need to be taken to comply with SPO.GEN.145(f)(1a). The inspection of the CVR recording usually consists of:
 - (1) checking that the CVR operates correctly for the nominal duration of the recording;
 - (2) examining, where practicable, a sample of in-flight recording of the CVR for evidence that the signal is acceptable on each channel; and
 - (3) preparing and retaining an inspection report.

- (c) The inspection of the DLR recording usually consists of:
- (1) Checking the consistency of the data link recording with other recordings for example, during a designated flight, the flight crew speaks out a few data link messages sent and received. After the flight, the data link recording and the CVR recording are compared for consistency.
 - (2) Retaining the most recent copy of the complete recording and the corresponding inspection report.

GM2 SPO.GEN.145(b) Handling of flight recorder recordings: preservation, production, protection and use

MONITORING AND CHECKING THE PROPER OPERATION OF FLIGHT RECORDERS – EXPLANATION OF TERMS

For the understanding of the terms used in AMC1 SPO.GEN.145(b):

- (a) ‘operational check of the flight recorder’ means a check of the flight recorder for proper operation. It is not a check of the quality of the recording and, therefore, it is not equivalent to an inspection of the recording. This check can be carried out by the flight crew or through a maintenance task.
- (b) ‘aural or visual means for preflight checking the flight recorders for proper operation’ means an aural or visual means for the flight crew to check before the flight the results of an automatically or manually initiated test of the flight recorders for proper operation. Such a means provides for an operational check that can be performed by the flight crew.
- (c) ‘flight recorder system’ means the flight recorder, its dedicated sensors and transducers, as well as its dedicated acquisition and processing equipment.
- (d) ‘continuous monitoring for proper operation’ means for a flight recorder system, a combination of system monitors and/or built-in test functions which operates continuously in order to detect the following:
 - (1) loss of electrical power to the flight recorder system;
 - (2) failure of the equipment performing acquisition and processing;
 - (3) failure of the recording medium and/or drive mechanism; and
 - (4) failure of the recorder to store the data in the recording medium as shown by checks of the recorded data including, as reasonably practicable for the storage medium concerned, correct correspondence with the input data.

However, detections by the continuous monitoring for proper operation do not need to be automatically reported to the flight crew compartment.

GM3 SPO.GEN.145(b) Handling of flight recorder recordings: preservation, production, protection and use

CVR AUDIO QUALITY

Examples of CVR audio quality issues and possible causes thereof may be found in the document of the French Bureau d’Enquêtes et d’Analyses, titled ‘Study on detection of audio anomalies on CVR recordings’ and dated September 2015².

² <http://www.bea.aero/en/bea/la-technique/guidance.on.detection.of.audio.anomalies.on.CVR.recordings.pdf>

AMC1 SPO.GEN.145(f) Handling of flight recorder recordings: preservation, production, protection and use

USE OF CVR RECORDINGS FOR MAINTAINING OR IMPROVING SAFETY

- (a) The procedure related to the handling of cockpit voice recorder (CVR) recordings should be written in a document which should be signed by all parties (aircraft operator, crew members, maintenance personnel if applicable). This procedure should, as a minimum, define:
- (1) the method to obtain the consent of all crew members and maintenance personnel concerned;
 - (2) an access and security policy that restricts access to CVR recordings and identified CVR transcripts to specifically authorised persons identified by their position;
 - (3) a retention policy and accountability, including the measures to be taken to ensure the security of the CVR recordings and CVR transcripts and their protection from misuse. The retention policy should specify the period of time after which CVR recordings and identified CVR transcripts are destroyed; and
 - (4) a description of the uses made of the CVR recordings and of their transcripts.
- (b) Each time a CVR recording file is read out under the conditions defined by SPO.GEN.145(f)(1):
- (1) parts of the CVR recording file that contain information with a privacy content should be deleted to the extent possible, and it should not be permitted that the detail of information with a privacy content is transcribed;
 - (2) the operator should retain, and when requested, provide to the competent authority:
 - (i) information on the use made (or the intended use) of the CVR recording; and
 - (ii) evidence that the persons concerned consented to the use made (or the intended use) of the CVR recording file.
- (c) The person who fulfils the role of a safety manager should also be responsible for the protection and the use of the CVR recordings and the CVR transcripts.
- (d) In case a third party is involved in the use of CVR recordings, contractual agreements with this third party should, when applicable, cover the aspects enumerated in (a) and (b).

AMC2 SPO.GEN.145(f) Handling of flight recorder recordings: preservation, production, protection and use

CVR RECORDING INSPECTION FOR ENSURING SERVICEABILITY

- (a) When an inspection of the CVR recording is performed for ensuring audio quality and intelligibility of recorded communications:
- (1) the privacy of the CVR recording should be ensured (e.g. by locating the equipment in a separated area and/or using headsets);
 - (2) access to the CVR replay equipment should be restricted to specifically authorised persons;
 - (3) provision should be made for the secure storage of the CVR recording medium, the CVR recording files and copies thereof;
 - (4) the CVR recording files and copies thereof should be destroyed not earlier than two months and not later than one year after completion of the CVR recording inspection,

except that audio samples may be retained for enhancing the CVR recording inspection (e.g. for comparing audio quality); and

- (5) only the accountable manager of the operator, and when identified to comply with ORO.GEN.200, the person fulfilling the role of safety manager, should be entitled to request a copy of the CVR recording file.
- (b) The conditions enumerated in (a) should also be complied if the inspection of the CVR recording is subcontracted to a third party. The contractual agreements with the third party should explicitly cover these aspects.

GM1 SPO.GEN.145(f) Handling of flight recorder recordings: preservation, production, protection and use

USE OF CVR RECORDINGS FOR MAINTAINING OR IMPROVING SAFETY

- (a) The CVR is primarily a tool for the investigation of accidents and serious incidents by investigating authorities. Misuse of CVR recordings is a breach of the right to privacy and it works against an effective safety culture inside the operator.
- (b) Therefore, the use of a CVR recording, when for purposes other than CVR serviceability or those laid down by Regulation (EU) No 996/2010, should be subject to the free prior consent of the persons concerned, and framed by a procedure that is endorsed by all parties and that protects the privacy of crew members and (if applicable) maintenance staff.

SPO.GEN.150 Transport of dangerous goods

- (a) The transport of dangerous goods by air shall be conducted in accordance with Annex 18 to the Chicago Convention as last amended and amplified by the Technical Instructions for the Safe Transport of Dangerous Goods by Air (ICAO Doc 9284-AN/905), including its attachments, supplements and any other addenda or corrigenda.
- (b) Dangerous goods shall only be transported by an operator approved in accordance with Annex V (Part-SPA), subpart G, to Regulation (EU) No 965/2012 except when:
- (1) they are not subject to the Technical Instructions in accordance with Part 1 of those Instructions;
 - (2) they are carried by task specialists or crew members or are in baggage which has been separated from its owner, in accordance with Part 8 of the Technical Instructions;
 - (3) required on board the aircraft for specialised purposes in accordance with the Technical Instructions;
 - (4) they are used to facilitate flight safety where carriage aboard the aircraft is reasonable to ensure their timely availability for operational purposes, whether or not such articles and substances are required to be carried or intended to be used in connection with a particular flight.
- (c) The operator shall establish procedures to ensure that all reasonable measures are taken to prevent dangerous goods from being carried on board inadvertently.
- (d) The operator shall provide personnel with the necessary information enabling them to carry out their responsibilities, as required by the Technical Instructions.
- (e) The operator shall, in accordance with the Technical Instructions, report without delay to the competent authority and the appropriate authority of the State of occurrence in the event of:
- (1) any dangerous good accident or incidents;
 - (2) the finding of dangerous goods carried by task specialists or crew, or in their baggage, when not in accordance with Part 8 of the Technical Instructions.
- (f) The operator shall ensure that task specialists are provided with information about dangerous goods.
- (g) The operator shall ensure that notices giving information about the transport of dangerous goods are provided at acceptance points for cargo as required by the Technical Instructions.

GM1 SPO.GEN.150(a) Transport of dangerous goods

GENERAL

- (a) The requirement to transport dangerous goods by air in accordance with the Technical Instructions is irrespective of whether:
- (1) the flight is wholly or partly within or wholly outside the territory of a State; or
 - (2) an approval to carry dangerous goods in accordance with Annex V (Part-SPA), Subpart DG is held.
- (b) The Technical Instructions provide that in certain circumstances dangerous goods, which are normally forbidden on an aircraft, may be carried. These circumstances include cases of extreme urgency or, when other forms of transport are inappropriate or when full compliance with the prescribed requirements is contrary to the public interest. In these circumstances all the States

concerned may grant exemptions from the provisions of the Technical Instructions provided that an overall level of safety that is at least equivalent to that provided by the Technical Instructions is achieved. Although exemptions are most likely to be granted for the carriage of dangerous goods that are not permitted in normal circumstances, they may also be granted in other circumstances, such as when the packaging to be used is not provided for by the appropriate packing method or the quantity in the packaging is greater than that permitted. The Technical Instructions also make provision for some dangerous goods to be carried when an approval has been granted only by the State of Origin and the competent authority.

- (c) When an exemption is required, the States concerned are those of origin, transit, overflight and destination of the consignment and that of the operator. For the State of overflight, if none of the criteria for granting an exemption are relevant, an exemption may be granted based solely on whether it is believed that an equivalent level of safety in air transport has been achieved.
- (d) The Technical Instructions provide that exemptions and approvals are granted by the 'appropriate national authority', which is intended to be the authority responsible for the particular aspect against which the exemption or approval is being sought. The operator should ensure that all relevant conditions on an exemption or approval are met.
- (e) The exemption or approval referred to in (b) to (d) is in addition to the approval required by Annex V (Part-SPA).

AMC1 SPO.GEN.150(e) Transport of dangerous goods

DANGEROUS GOODS ACCIDENT AND INCIDENT REPORTING

- (a) Any type of dangerous goods incident or accident should be reported. For this purpose, the Technical Instructions consider that reporting of undeclared and misdeclared dangerous goods found in cargo also applies to items of operators' stores that are classified as dangerous goods.
- (b) The first report should be dispatched within 72 hours of the event. It may be sent by any means, including e-mail, telephone or fax. This report should include the details that are known at that time, under the headings identified in (c). If necessary, a subsequent report should be made as soon as possible giving all the details that were not known at the time the first report was sent. If a report has been made verbally, written confirmation should be sent as soon as possible.
- (c) The first and any subsequent report should be as precise as possible and contain the following data, where relevant:
 - (1) date of the incident or accident or the finding of undeclared or misdeclared dangerous goods;
 - (2) location and flight date;
 - (3) description of the goods;
 - (4) proper shipping name (including the technical name, if appropriate) and United Nations (UN)/identification (ID) number, when known;
 - (5) class or division and any subsidiary risk;
 - (6) type of packaging, and the packaging specification marking on it;
 - (7) quantity;
 - (8) any other relevant details;
 - (9) suspected cause of the incident or accident;

- (10) action taken;
- (11) any other reporting action taken; and
- (12) name, title, address and telephone number of the person making the report.
- (d) Copies of relevant documents and any photographs taken should be attached to the report.
- (e) A dangerous goods accident or incident may also constitute an aircraft accident, serious incident or incident. The criteria for reporting both types of occurrence should be met.
- (f) The following dangerous goods reporting form should be used, but other forms, including electronic transfer of data, may be used provided that at least the minimum information of this AMC is supplied:

DANGEROUS GOODS OCCURRENCE REPORT			DGOR No:
1. Operator:	2. Date of Occurrence:	3. Local time of occurrence:	
4. Flight date:		5. Reserved:	
6. Departure aerodrome:		7. Destination aerodrome:	
8. Aircraft type:		9. Aircraft registration:	
10. Location of occurrence:		11. Origin of the goods:	
12. Description of the occurrence, including details of injury, damage, etc. (if necessary continue on the reverse of this form):			
13. Proper shipping name (including the technical name):			14. UN/ID No (when known):
15. Class/Division (when known):	16. Subsidiary risk(s):	17. Packing group:	18. Category (Class 7 only):
19. Type of packaging:	20. Packaging specification marking:	21. No of packages:	22. Quantity (or transport index, if applicable):
23. Other relevant information (including suspected cause, any action taken):			

24. Name and title of person making report:	25. Telephone No:
26. Company:	27. Reporters ref:
28. Address:	29. Signature:
	30. Date:
Description of the occurrence (continuation)	

Notes for completion of the form:

1. A dangerous goods accident is as defined in Annex I. For this purpose serious injury is as defined in Regulation (EU) No 996/2010 of the European Parliament and of the Council³.
2. The initial report should be dispatched unless exceptional circumstances prevent this. This occurrence report form, duly completed, should be sent as soon as possible, even if all the information is not available.
3. Copies of all relevant documents and any photographs should be attached to this report.
4. Any further information, or any information not included in the initial report, should be sent as soon as possible to the authorities identified in SPO.GEN.150(e).
5. Providing it is safe to do so, all dangerous goods, packaging, documents, etc. relating to the occurrence should be retained until after the initial report has been sent to the authorities identified in SPO.GEN.150(e), and they have indicated whether or not these should continue to be retained.

³ Regulation (EU) No 996/2010 of the European Parliament and of the Council of 20 October 2010 on the investigation and prevention of accidents and incidents in civil aviation and repealing Directive 94/56/EC (OJ L 295, 12.11.2010, p. 35).

SPO.GEN.155 Release of dangerous goods

The operator shall not operate an aircraft over congested areas of cities, towns or settlements or over an open-air assembly of persons when releasing dangerous goods.

SPO.GEN.160 Carriage and use of weapons

- (a) The operator shall ensure that, when weapons are carried on a flight for the purpose of a specialised task, these are secured when not in use.
- (b) The task specialist using the weapon shall take all necessary measures to prevent the aircraft and persons on board or on the ground from being endangered.

SPO.GEN.165 Admission to the flight crew compartment

The pilot-in-command shall make the final decision regarding the admission to the flight crew compartment and shall ensure that:

- (a) admission to the flight crew compartment does not cause distraction or interference with the operation of the flight; and
- (b) all persons carried in the flight crew compartment are made familiar with the relevant safety procedures.

SUBPART B: OPERATIONAL PROCEDURES

SPO.OP.100 Use of aerodromes and operating sites

The operator shall only use aerodromes and operating sites that are adequate for the type of aircraft and operation concerned.

AMC1 SPO.OP.100 Use of aerodromes and operating sites

USE OF OPERATING SITES MOTOR-POWERED AIRCRAFT

- (a) When defining adequate operating sites for use for the type(s) of aircraft and operation(s) concerned, the operator should take account of the following:
- (1) An adequate site is a site that the operator considers to be satisfactory, taking account of the applicable performance requirements and site characteristics.
 - (2) The operator should have in place a procedure for the survey of operating sites by a competent person. Such a procedure should take account for possible changes to the operating site characteristics that may have taken place since last surveyed.
- (b) Operating sites that are pre-surveyed should be specifically specified in the operations manual. The operations manual should contain diagrams or ground and aerial photographs, depiction (pictorial) and description of:
- (1) the overall dimensions of the operating site;
 - (2) location and height of relevant obstacles to approach and take-off profiles and in the manoeuvring area;
 - (3) approach and take-off flight paths;
 - (4) surface condition (blowing dust/snow/sand);
 - (5) provision of control of third parties on the ground, if applicable;
 - (6) lighting, if applicable;
 - (7) procedure for activating the operating site in accordance with national regulations, if applicable;
 - (8) other useful information, for example details of the appropriate ATS agency and frequency; and
 - (9) site suitability with reference to available aircraft performance.
- (c) Where the operator specifically permits operation from sites that are not pre-surveyed, the pilot-in-command should make, from the air a judgement on the suitability of a site. At least (b)(1) to (b)(6) inclusive and (b)(9) should be considered. Operations to non-pre-surveyed operating sites by night should not be conducted.

GM1 SPO.OP.100 Use of aerodromes and operating sites

ADEQUATE SITES — BALLOONS

An adequate site is a site that the pilot-in-command considers to be satisfactory, taking account of the applicable performance requirements and site characteristics.

SPO.OP.105 Specification of isolated aerodromes — aeroplanes

For the selection of alternate aerodromes and the fuel policy, the operator shall consider an aerodrome as an isolated aerodrome if the flying time to the nearest adequate destination alternate aerodrome is more than:

- (a) for aeroplanes with reciprocating engines, 60 minutes; or
- (b) for aeroplanes with turbine engines, 90 minutes.

SPO.OP.110 Aerodrome operating minima — aeroplanes and helicopters

- (a) For instrument flight rules (IFR) flights, the operator or the pilot-in-command shall specify aerodrome operating minima for each departure, destination and alternate aerodrome to be used. Such minima shall:
 - (1) not be lower than those established by the State in which the aerodrome is located, except when specifically approved by that State; and
 - (2) when undertaking low visibility operations, be approved by the competent authority in accordance with Annex V (Part-SPA), Subpart E to Regulation (EU) No 965/2012.
- (b) When specifying the aerodrome operating minima, the operator or the pilot-in-command shall take the following into account:
 - (1) the type, performance and handling characteristics of the aircraft;
 - (2) the competence and experience of the flight crew and, if applicable, its composition;
 - (3) the dimensions and characteristics of the runways and final approach and take-off areas (FATOs) that may be selected for use;
 - (4) the adequacy and performance of the available visual and non-visual ground aids;
 - (5) the equipment available on the aircraft for the purpose of navigation and/or control of the flight path, during the take-off, the approach, the flare, the landing, the rollout and the missed approach;
 - (6) the obstacles in the approach, the missed approach and the climb-out areas required for the execution of contingency procedures;
 - (7) the obstacle clearance altitude/height for the instrument approach procedures;
 - (8) the means to determine and report meteorological conditions; and
 - (9) the flight technique to be used during the final approach.
- (c) The minima for a specific type of approach and landing procedure shall only be used if:
 - (1) the ground equipment required for the intended procedure is operative;
 - (2) the aircraft systems required for the type of approach are operative;
 - (3) the required aircraft performance criteria are met; and
 - (4) the flight crew is qualified appropriately.

AMC1 SPO.OP.110 Aerodrome operating minima — aeroplanes and helicopters

COMMERCIALY AVAILABLE INFORMATION

An acceptable method of specifying aerodrome operating minima is through the use of commercially available information.

AMC2 SPO.OP.110 Aerodrome operating minima – aeroplanes and helicopters

VISUAL APPROACH OPERATIONS

For a visual approach operation, the runway visual range (RVR) should not be less than 800 m.

AMC3 SPO.OP.110 Aerodrome operating minima – aeroplanes and helicopters

GENERAL

- (a) The aerodrome operating minima should not be lower than as specified in SPO.OP.111 or AMC4 SPO.OP.110(c).
- (b) Whenever practical approaches should be flown as stabilised approaches (SAPs). Different procedures may be used for a particular approach to a particular runway.
- (c) Whenever practical, non-precision approaches should be flown using the continuous descent final approach (CDFA) technique. Different procedures may be used for a particular approach to a particular runway.
- (d) For approaches not flown using the CDFA technique: when calculating the minima in accordance with SPO.OP.111, the applicable minimum runway visual range (RVR) should be increased by 200 m for Category A and B aeroplanes and by 400 m for Category C and D aeroplanes, provided the resulting RVR/converted meteorological visibility (CMV) value does not exceed 5 000 m. SAP or CDFA should be used as soon as facilities are improved to allow these techniques.

AMC4 SPO.OP.110 Aerodrome operating minima – aeroplanes and helicopters

TAKE-OFF OPERATIONS WITH COMPLEX MOTOR-POWERED AIRCRAFT

- (a) General:
 - (1) Take-off minima should be expressed as visibility (VIS) or RVR limits, taking into account all relevant factors for each aerodrome planned to be used and aircraft characteristics. Where there is a specific need to see and avoid obstacles on departure and/or for a forced landing, additional conditions, e.g. ceiling, should be specified.
 - (2) The pilot-in-command should not commence take-off unless the weather conditions at the aerodrome of departure are equal to or better than applicable minima for landing at that aerodrome, unless a weather-permissible take-off alternate aerodrome is available.
 - (3) When the reported meteorological visibility is below that required for take-off and RVR is not reported, a take-off should only be commenced if the pilot-in-command can determine that the visibility along the take-off runway/area is equal to or better than the required minimum.
 - (4) When no reported meteorological visibility or RVR is available, a take-off should only be commenced if the pilot-in-command can determine that the RVR/VIS along the take-off runway/area is equal to or better than the required minimum.
- (b) Visual reference:
 - (1) The take-off minima should be selected to ensure sufficient guidance to control the aircraft in the event of both a rejected take-off in adverse circumstances and a continued take-off after failure of the critical engine.
 - (2) For night operations, ground lights should be available to illuminate the runway/final approach and take-off area (FATO) and any obstacles.

(c) Required RVR/visibility:

(1) Aeroplanes:

- (i) For aeroplanes, the take-off minima specified by the operator should be expressed as RVR/VIS values not lower than those specified in Table 1.A.
- (ii) When reported RVR or meteorological visibility is not available, the pilot-in-command should not commence take-off unless he/she can determine that the actual conditions satisfy the applicable take-off minima.

(2) Helicopters:

- (i) For helicopters having a mass where it is possible to reject the take-off and land on the FATO in case of the critical engine failure being recognised at or before the take-off decision point (TDP), the operator should specify an RVR/VIS as take-off minima in accordance with Table 1.H.
- (ii) For all other cases, the pilot-in-command should operate to take-off minima of 800 m RVR/VIS and remain clear of cloud during the take-off manoeuvre until reaching the performance capabilities of (c)(2)(i).
- (iii) Table 1 of AMC9-SPO.OP.110, for converting reported meteorological visibility to RVR, should not be used for calculating take-off minima.

**Table 1.A: Take-off — aeroplanes
(without low visibility take-off (LVTO) approval) — RVR/VIS**

Facilities	RVR/VIS (m)*
Day only: Nil**	500
Day: at least runway edge lights or runway centreline markings Night: at least runway edge lights or runway centreline lights and runway end lights	400

*: The reported RVR/VIS value representative of the initial part of the take-off run can be replaced by pilot assessment.

** : The pilot is able to continuously identify the take-off surface and maintain directional control.

**Table 1.H: Take-off — helicopters
(without LVTO approval) — RVR/Visibility**

Onshore aerodromes with instrument flight rules (IFR) departure procedures	RVR/VIS (m)
No light and no markings (day only)	400 or the rejected take-off distance, whichever is the greater
No markings (night)	800
Runway edge/FATO light and centreline marking	400
Runway edge/FATO light, centreline marking and relevant RVR information	400
Offshore helideck *	
Two-pilot operations	400
Single-pilot operations	500

*: The take-off flight path to be free of obstacles.

AMC5 SPO.OP.110 Aerodrome operating minima — aeroplanes and helicopters

TAKE-OFF OPERATIONS WITH OTHER-THAN COMPLEX MOTOR-POWERED AIRCRAFT

(a) General:

- (1) Take-off minima should be expressed as VIS or RVR limits, taking into account all relevant factors for each aerodrome planned to be used and aircraft characteristics. Where there is a specific need to see and avoid obstacles on departure and/or for a forced landing, additional conditions, e.g. ceiling, it should be specified.
- (2) When the reported meteorological visibility is below that required for take-off and RVR is not reported, a take-off should only be commenced if the pilot-in-command can determine that the visibility along the take-off runway/area is equal to or better than the required minimum.
- (3) When no reported meteorological visibility or RVR is available, a take-off should only be commenced if the pilot-in-command can determine that the RVR/VIS along the take-off runway/area is equal to or better than the required minimum.

(b) Visual reference:

- (1) The take-off minima should be selected to ensure sufficient guidance to control the aircraft in the event of both a rejected take-off in adverse circumstances and a continued take-off after failure of the critical engine.
- (2) For night operations, ground lights should be available to illuminate the runway/final approach and take-off area (FATO) and any obstacles.

AMC6 SPO.OP.110 Aerodrome operating minima — aeroplanes and helicopters

CRITERIA FOR ESTABLISHING RVR/CMV

- (a) In order to qualify for the lowest allowable values of RVR/CMV specified in Table 4.A of AMC7 SPO.OP.110, the instrument approach should meet at least the following facility requirements and associated conditions:
- (1) Instrument approaches with designated vertical profile up to and including 4.5° for Category A and B aeroplanes, or 3.77° for Category C and D aeroplanes, where the facilities are:
 - (i) instrument landing system (ILS)/microwave landing system (MLS)/GBAS landing system (GLS)/precision approach radar (PAR)); or
 - (ii) approach procedure with vertical guidance (APV); and
 where the final approach track is offset by not more than 15° for Category A and B aeroplanes or by not more than 5° for Category C and D aeroplanes.
 - (2) Instrument approach operations flown using the CDFA technique with a nominal vertical profile, up to and including 4.5° for Category A and B aeroplanes, or 3.77° for Category C and D aeroplanes, where the facilities are non-directional beacon (NDB), NDB/distance measuring equipment (DME), VHF omnidirectional radio range (VOR), VOR/DME, localiser (LOC), LOC/DME, VHF direction finder (VDF), surveillance radar approach (SRA) or global navigation satellite system (GNSS)/lateral navigation (LNAV), with a final approach segment of at least 3 NM, which also fulfil the following criteria:
 - (i) the final approach track is offset by not more than 15° for Category A and B aeroplanes or by not more than 5° for Category C and D aeroplanes;
 - (ii) the final approach fix (FAF) or another appropriate fix where descent is initiated is available, or distance to threshold (THR) is available by flight management system (FMS)/area navigation (NDB/DME) or DME; and
 - (iii) the missed approach point (MAPt) is determined by timing, the distance from FAF to THR is ≤ 8 NM.
 - (3) Instrument approaches where the facilities are NDB, NDB/DME, VOR, VOR/DME, LOC, LOC/DME, VDF, SRA or GNSS/LNAV, not fulfilling the criteria in (a)(2), or with an minimum descent height (MDH) ≥ 1 200 ft.
- (b) The missed approach operation, after an approach operation has been flown using the CDFA technique, should be executed when reaching the decision height/altitude (DH/A) or the MAPt, whichever occurs first. The lateral part of the missed approach procedure should be flown via the MAPt unless otherwise stated on the approach chart.

AMC7 SPO.OP.110 Aerodrome operating minima — aeroplanes and helicopters

DETERMINATION OF RVR/CMV/VIS MINIMA FOR NPA, APV, CAT I — AEROPLANES

- (a) The minimum RVR/CMV/VIS should be the highest of the values specified in Table 3 and Table 4.A but not greater than the maximum values specified in Table 4.A, where applicable.
- (b) The values in Table 2 should be derived from the formula below:
- $$\text{required RVR/VIS (m)} = [(DH/MDH \text{ (ft)} \times 0.3048) / \tan \alpha] \text{ — length of approach lights (m);}$$
- where α is the calculation angle, being a default value of 3.00° increasing in steps of 0.10° for each line in Table 3 up to 3.77° and then remaining constant.

- (c) If the approach is flown with a level flight segment at or above MDA/H, 200 m should be added for Category A and B aeroplanes and 400 m for Category C and D aeroplanes to the minimum RVR/CMV/VIS value resulting from the application of Table 3 and Table 4.A.
- (d) An RVR of less than 750 m as indicated in Table 3 may be used:
- (1) for CAT I operations to runways with full approach lighting system (FALS), runway touchdown zone lights (RTZL) and runway centreline lights (RCLL);
 - (2) for CAT I operations to runways without RTZL and RCLL when using an approved head-up guidance landing system (HUDLS), or equivalent approved system, or when conducting a coupled approach or flight-director-flown approach to a DH. The ILS should not be published as a restricted facility; and
 - (3) for APV operations to runways with FALS, RTZL and RCLL when using an approved head-up display (HUD).
- (e) Lower values than those specified in Table 3 may be used for HUDLS and auto-land operations if approved in accordance with Annex V (Part-SPA), Subpart E.
- (f) The visual aids should comprise standard runway day markings and approach and runway lights as specified in Table 2.
- (g) For night operations or for any operation where credit for runway and approach lights is required, the lights should be on and serviceable, except as provided for in Table 6 of AMC 10 SPO.OP.110.
- (h) For single-pilot operations, the minimum RVR/VIS should be calculated in accordance with the following additional criteria:
- (1) an RVR of less than 800 m as indicated in Table 3 may be used for CAT I approaches provided any of the following is used at least down to the applicable DH:
 - (i) a suitable autopilot, coupled to an ILS, MLS or GLS that is not published as restricted; or
 - (ii) an approved HUDLS, including, where appropriate, enhanced vision system (EVS), or equivalent approved system;
 - (2) where RTZL and/or RCLL are not available, the minimum RVR/CMV should not be less than 600 m; and
 - (3) an RVR of less than 800 m as indicated in Table 3 may be used for APV operations to runways with FALS, RTZL and RCLL when using an approved HUDLS, or equivalent approved system, or when conducting a coupled approach to a DH equal to or greater than 250 ft.

Table 2: Approach lighting systems

Class of lighting facility	Length, configuration and intensity of approach lights
FALS	CAT I lighting system (HIALS \geq 720 m) distance coded centreline, Barrette centreline
IALS	Simple approach lighting system (HIALS 420 – 719 m) single source, Barrette
BALS	Any other approach lighting system (HIALS, MIALS or ALS 210 – 419 m)
NALS	Any other approach lighting system (HIALS, MIALS or ALS $<$ 210 m) or no approach lights

Note: HIALS: high intensity approach lighting system;
 MIALS: medium intensity approach lighting system;
 ALS: approach lighting system.

Table 3: RVR/CMV vs DH/MDH

DH or MDH			Class of lighting facility			
			FALS	IALS	BALS	NALS
			See (d), (e), (h) above for RVR < 750/800 m			
ft			RVR/CMV (m)			
200	-	210	550	750	1 000	1 200
211	-	220	550	800	1 000	1 200
221	-	230	550	800	1 000	1 200
231	-	240	550	800	1 000	1 200
241	-	250	550	800	1 000	1 300
251	-	260	600	800	1 100	1 300
261	-	280	600	900	1 100	1 300
281	-	300	650	900	1 200	1 400
301	-	320	700	1 000	1 200	1 400
321	-	340	800	1 100	1 300	1 500
341	-	360	900	1 200	1 400	1 600
361	-	380	1 000	1 300	1 500	1 700
381	-	400	1 100	1 400	1 600	1 800
401	-	420	1 200	1 500	1 700	1 900
421	-	440	1 300	1 600	1 800	2 000
441	-	460	1 400	1 700	1 900	2 100
461	-	480	1 500	1 800	2 000	2 200
481		500	1 500	1 800	2 100	2 300
501	-	520	1 600	1 900	2 100	2 400
521	-	540	1 700	2 000	2 200	2 400

DH or MDH			Class of lighting facility			
			FALS	IALS	BALS	NALS
			See (d), (e), (h) above for RVR < 750/800 m			
ft			RVR/CMV (m)			
541	-	560	1 800	2 100	2 300	2 500
561	-	580	1 900	2 200	2 400	2 600
581	-	600	2 000	2 300	2 500	2 700
601	-	620	2 100	2 400	2 600	2 800
621	-	640	2 200	2 500	2 700	2 900
641	-	660	2 300	2 600	2 800	3 000
661	-	680	2 400	2 700	2 900	3 100
681	-	700	2 500	2 800	3 000	3 200
701	-	720	2 600	2 900	3 100	3 300
721	-	740	2 700	3 000	3 200	3 400
741	-	760	2 700	3 000	3 300	3 500
761	-	800	2 900	3 200	3 400	3 600
801	-	850	3 100	3 400	3 600	3 800
851	-	900	3 300	3 600	3 800	4 000
901	-	950	3 600	3 900	4 100	4 300
951	-	1 000	3 800	4 100	4 300	4 500
1 001	-	1 100	4 100	4 400	4 600	4 900
1 101	-	1 200	4 600	4 900	5 000	5 000
1 201 and above			5 000	5 000	5 000	5 000

Table 4.A: CAT I, APV, NPA — aeroplanes
Minimum and maximum applicable RVR/CMV (lower and upper cut-off limits)

Facility/conditions	RVR/CMV (m)	Aeroplane category			
		A	B	C	D
ILS, MLS, GLS, PAR, GNSS/SBAS, GNSS/VNAV	Min	According to Table 3			
	Max	1 500	1 500	2 400,	2 400
NDB, NDB/DME, VOR, VOR/DME, LOC, LOC/DME, VDF, SRA, GNSS/LNAV with a procedure that fulfils the criteria in AMC6 SPO.OP.110 (a)(2).	Min	750	750	750	750
	Max	1 500	1 500	2 400	2 400
For NDB, NDB/DME, VOR, VOR/DME, LOC, LOC/DME, VDF, SRA, GNSS/LNAV: — not fulfilling the criteria in AMC6 SPO.OP.110 (a)(2)., or — with a DH or MDH \geq 1 200 ft	Min	1 000	1 000	1 200	1 200
	Max	According to Table 3, if flown using the CDFA technique, otherwise an add-on of 200/400 m applies to the values in Table 3 but not to result in a value exceeding 5 000 m.			

AMC8 SPO.OP.110 Aerodrome operating minima — aeroplanes and helicopters

DETERMINATION OF RVR/CMV/VIS MINIMA FOR NPA, CAT I — HELICOPTERS

- (a) For non-precision approach (NPA) operations, the minima specified in Table 4.1.H should apply:
- (1) where the missed approach point is within $\frac{1}{2}$ NM of the landing threshold, the approach minima specified for FALS may be used regardless of the length of approach lights available. However, FATO/runway edge lights, threshold lights, end lights and FATO/runway markings are still required;
 - (2) for night operations, ground lights should be available to illuminate the FATO/runway and any obstacles; and
 - (3) for single-pilot operations, the minimum RVR is 800 m or the minima in Table 4.2.H, whichever is higher.
- (b) For CAT I operations, the minima specified in Table 4.2.H should apply:
- (1) for night operations, ground light should be available to illuminate the FATO/runway and any obstacles;
 - (2) for single-pilot operations, the minimum RVR/VIS should be calculated in accordance with the following additional criteria:
 - (i) an RVR of less than 800 m should not be used except when using a suitable autopilot coupled to an ILS, MLS or GLS, in which case normal minima apply; and
 - (ii) the DH applied should not be less than 1.25 times the minimum use height for the autopilot.

Table 4.1.H: Onshore NPA minima

MDH (ft) *	Facilities vs. RVR/CMV (m) **, ***			
	FALS	IALS	BALS	NALS
250 – 299	600	800	1 000	1 000
300 – 449	800	1 000	1 000	1 000
450 and above	1 000	1 000	1 000	1 000

*: The MDH refers to the initial calculation of MDH. When selecting the associated RVR, there is no need to take account of a rounding up to the nearest 10 ft, which may be done for operational purposes, e.g. conversion to MDA.

** : The tables are only applicable to conventional approaches with a nominal descent slope of not greater than 4°. Greater descent slopes will usually require that visual glide slope guidance (e.g. precision path approach indicator (PAPI)) is also visible at the MDH.

***: FALS comprise FATO/runway markings, 720 m or more of high intensity/medium intensity (HI/MI) approach lights, FATO/runway edge lights, threshold lights and FATO/runway end lights. Lights to be on.

IALS comprise FATO/runway markings, 420 – 719 m of HI/MI approach lights, FATO/runway edge lights, threshold lights and FATO/runway end lights. Lights to be on.

BALS comprise FATO/runway markings, < 420 m of HI/MI approach lights, any length of low intensity (LI) approach lights, FATO/runway edge lights, threshold lights and FATO/runway end lights. Lights to be on.

NALS comprise FATO/runway markings, FATO/runway edge lights, threshold lights, FATO/runway end lights or no lights at all.

Table 4.2.H: Onshore CAT I minima

DH (ft) *	Facilities vs. RVR/CMV (m) **, ***			
	FALS	IALS	BALS	NALS
200	500	600	700	1 000
201 – 250	550	650	750	1 000
251 – 300	600	700	800	1 000
301 and above	750	800	900	1 000

*: The DH refers to the initial calculation of DH. When selecting the associated RVR, there is no need to take account of a rounding up to the nearest 10 ft, which may be done for operational purposes, e.g. conversion to DA.

** : The table is applicable to conventional approaches with a glide slope up to and including 4°.

***: FALS comprise FATO/runway markings, 720 m or more of HI/MI approach lights, FATO/runway edge lights, threshold lights and FATO/runway end lights. Lights to be on.

IALS comprise FATO/runway markings, 420 – 719 m of HI/MI approach lights, FATO/runway edge lights, threshold lights and FATO/runway end lights. Lights to be on.

BALS comprise FATO/runway markings, < 420 m of HI/MI approach lights, any length of LI approach lights, FATO/runway edge lights, threshold lights and FATO/runway end lights. Lights to be on.

NALS comprise FATO/runway markings, FATO/runway edge lights, threshold lights, FATO/runway end lights or no lights at all.

AMC9 SPO.OP.110 Aerodrome operating minima — aeroplanes and helicopters

CONVERSION OF REPORTED METEOROLOGICAL VISIBILITY TO RVR/CMV

- (a) A conversion from meteorological visibility to RVR/CMV should not be used:
- (1) when reported RVR is available;
 - (2) for calculating take-off minima; and
 - (3) for other RVR minima less than 800 m.
- (b) If the RVR is reported as being above the maximum value assessed by the aerodrome operator, e.g. 'RVR more than 1 500 m', it should not be considered as a reported value for (a)(1).
- (c) When converting meteorological visibility to RVR in circumstances other than those in (a), the conversion factors specified in Table 5 should be used.

Table 5: Conversion of reported meteorological visibility to RVR/CMV

Light elements in operation	RVR/CMV = reported meteorological visibility x	
	Day	Night
HI approach and runway lights	1.5	2.0
Any type of light installation other than above	1.0	1.5
No lights	1.0	not applicable

AMC10 SPO.OP.110 Aerodrome operating minima — aeroplanes and helicopters

EFFECT ON LANDING MINIMA OF TEMPORARILY FAILED OR DOWNGRADED GROUND EQUIPMENT — COMPLEX MOTOR-POWERED AIRCRAFT

- (a) General
- These instructions are intended for both pre-flight and in-flight use. It is however not expected that the pilot-in-command would consult such instructions after passing 1 000 ft above the aerodrome. If failures of ground aids are announced at such a late stage, the approach could be continued at the pilot-in-command's discretion. If failures are announced before such a late stage in the approach, their effect on the approach should be considered as described in Table 6 and, if considered necessary, the approach should be abandoned.
- (b) Conditions applicable to Table 6:
- (1) multiple failures of runway/FATO lights other than indicated in Table 6 should not be acceptable;

- (2) deficiencies of approach and runway/FATO lights are treated separately; and
- (3) failures other than ILS, MLS affect RVR only and not DH.

Table 6: Failed or downgraded equipment — effect on landing minima

Failed or downgraded equipment	Effect on landing minima	
	CAT I	APV, NPA
ILS/MLS standby transmitter	No effect	
Outer marker	No effect if replaced by height check at 1 000 ft	APV — not applicable
		NPA with FAF: no effect unless used as FAF
		If the FAF cannot be identified (e.g. no method available for timing of descent), non-precision operations cannot be conducted
Middle marker	No effect	No effect unless used as MAPt
RVR Assessment Systems	No effect	
Approach lights	Minima as for NALS	
Approach lights except the last 210 m	Minima as for BALS	
Approach lights except the last 420 m	Minima as for IALS	
Standby power for approach lights	No effect	
Edge lights, threshold lights and runway end lights	Day — no effect Night — not allowed	
Centreline lights	No effect if flight director (F/D), HUDLS or auto-land; otherwise RVR 750 m	No effect
Centreline lights spacing increased to 30 m	No effect	
Touchdown zone lights	No effect if F/D, HUDLS or auto-land; otherwise RVR 750 m	No effect
Taxiway lighting system	No effect	

AMC11 SPO.OP.110 Aerodrome operating minima — aeroplanes and helicopters**EFFECT ON LANDING MINIMA OF TEMPORARILY FAILED OR DOWNGRADED GROUND EQUIPMENT — OTHER-THAN COMPLEX MOTOR-POWERED AIRCRAFT**

- (a) Non-precision approaches requiring a final approach fix (FAF) and/or MAPt should not be conducted where a method of identifying the appropriate fix is not available.
- (b) A minimum RVR of 750 m should be used for CAT I operations in the absence of centreline lines and/or touchdown zone lights.
- (c) Where approach lighting is partly unavailable, minima should take account of the serviceable length of approach lighting.

GM1 SPO.OP.110 Aerodrome operating minima — aeroplanes and helicopters**AIRCRAFT CATEGORIES**

- (a) Aircraft categories should be based on the indicated airspeed at threshold (V_{AT}), which is equal to the stalling speed (V_{SO}) multiplied by 1.3 or where published 1-g (gravity) stall speed (V_{S1g}) multiplied by 1.23 in the landing configuration at the maximum certified landing mass. If both V_{SO} and V_{S1g} are available, the higher resulting V_{AT} should be used.
- (b) The aircraft categories specified in Table 1 should be used.

Table 1: Aircraft categories corresponding to V_{AT} values

Aircraft category	V_{AT}
A	Less than 91 kt
B	from 91 to 120 kt
C	from 121 to 140 kt
D	from 141 to 165 kt
E	from 166 to 210 kt

GM2 SPO.OP.110 Aerodrome operating minima — aeroplanes and helicopters**CONTINUOUS DESCENT FINAL APPROACH (CDFA) — AEROPLANES**

- (a) Introduction
 - (1) Controlled flight into terrain (CFIT) is a major hazard in aviation. Most CFIT accidents occur in the final approach segment of non-precision approaches; the use of stabilised-approach criteria on a continuous descent with a constant, predetermined vertical path is seen as a major improvement in safety during the conduct of such approaches. Operators should ensure that the following techniques are adopted as widely as possible, for all approaches.
 - (2) The elimination of level flight segments at MDA close to the ground during approaches, and the avoidance of major changes in attitude and power/thrust close to the runway that can destabilise approaches, are seen as ways to reduce operational risks significantly.
 - (3) The term CDFA has been selected to cover a flight technique for any type of NPA operation.

-
- (4) The advantages of CDFA are as follows:
- (i) the technique enhances safe approach operations by the utilisation of standard operating practices;
 - (ii) the technique is similar to that used when flying an ILS approach, including when executing the missed approach and the associated missed approach procedure manoeuvre;
 - (iii) the aeroplane attitude may enable better acquisition of visual cues;
 - (iv) the technique may reduce pilot workload;
 - (v) the approach profile is fuel efficient;
 - (vi) the approach profile affords reduced noise levels; and
 - (vii) the technique affords procedural integration with APV operations.
- (b) CDFA
- (1) Continuous descent final approach is defined in Annex I to the Regulation on Air operations.
 - (2) An approach is only suitable for application of a CDFA technique when it is flown along a nominal vertical profile; a nominal vertical profile is not forming part of the approach procedure design, but can be flown as a continuous descent. The nominal vertical profile information may be published or displayed on the approach chart to the pilot by depicting the nominal slope or range/distance vs height. Approaches with a nominal vertical profile are considered to be:
 - (i) NDB, NDB/DME;
 - (ii) VOR, VOR/DME;
 - (iii) LOC, LOC/DME;
 - (iv) VDF, SRA; and
 - (v) GNSS/LNAV.
 - (3) Stabilised approach (SAp) is defined in Annex I to the Regulation on Air Operations.
 - (i) The control of the descent path is not the only consideration when using the CDFA technique. Control of the aeroplane's configuration and energy is also vital to the safe conduct of an approach.
 - (ii) The control of the flight path, described above as one of the requirements for conducting an SAp, should not be confused with the path requirements for using the CDFA technique.
 - (iii) The predetermined approach slope requirements for applying the CDFA technique are established by the following:
 - (A) the published 'nominal' slope information when the approach has a nominal vertical profile; and
 - (B) the designated final-approach segment minimum of 3 NM, and maximum, when using timing techniques, of 8 NM.
 - (iv) An SAp will never have any level segment of flight at DA/H or MDA/H, as applicable. This enhances safety by mandating a prompt missed approach procedure manoeuvre at DA/H or MDA/H.

- (v) An approach using the CDFA technique will always be flown as an SAp, since this is a requirement for applying CDFA. However, an SAp does not have to be flown using the CDFA technique, for example a visual approach.

GM3 SPO.OP.110 Aerodrome operating minima — aeroplanes and helicopters**ONSHORE AERODROME DEPARTURE PROCEDURES — OPERATIONS WITH NON-COMPLEX HELICOPTERS**

The cloud base and visibility should be such as to allow the helicopter to be clear of cloud at the take-off decision point (TDP), and for the pilot flying to remain in sight of the surface until reaching the minimum speed for flight in instrument meteorological conditions, as given in the AFM.

GM4 SPO.OP.110 Aerodrome operating minima — aeroplanes and helicopters**TAKE-OFF MINIMA — OPERATIONS WITH COMPLEX HELICOPTERS**

- (a) To ensure sufficient control of the helicopter in IMC, the speed, before entering in IMC, should be above the minimum authorised speed in IMC, V_{mini} . This is a limitation in the AFM. Therefore, the lowest speed before entering in IMC is the highest of V_{toss} (velocity take-off safety speed) and V_{mini} .
- (b) As example, V_{toss} is 45 kt and V_{mini} 60 kt. In that case, the take-off minima have to include the distance to accelerate to 60 kt. The take-off distance should be increased accordingly.

SPO.OP.111 Aerodrome operating minima — NPA, APV, CAT I operations

- (a) The decision height (DH) to be used for a non-precision approach (NPA) flown with the continuous descent final approach (CDFA) technique, approach procedure with vertical guidance (APV) or category I (CAT I) operation shall not be lower than the highest of:
- (1) the minimum height to which the approach aid can be used without the required visual reference;
 - (2) the obstacle clearance height (OCH) for the category of aircraft;
 - (3) the published approach procedure DH where applicable;
 - (4) the system minimum specified in Table 1; or
 - (5) the minimum DH specified in the AFM or equivalent document, if stated.
- (b) The minimum descent height (MDH) for an NPA operation flown without the CDFA technique shall not be lower than the highest of:
- (1) the OCH for the category of aircraft;
 - (2) the system minimum specified in Table 1; or
 - (3) the minimum MDH specified in the AFM, if stated.

Table 1**System minima**

Facility	Lowest DH/MDH (ft)
Instrument landing system (ILS)	200
Global navigation satellite system (GNSS)/satellite-based augmentation system (SBAS) (lateral precision with vertical guidance approach (LPV))	200
GNSS (lateral navigation (LNAV))	250
GNSS/Baro-vertical navigation (VNAV) (LNAV/VNAV)	250
Localiser (LOC) with or without distance measuring equipment (DME)	250
Surveillance radar approach (SRA) (terminating at ½ NM)	250
SRA (terminating at 1 NM)	300
SRA (terminating at 2 NM or more)	350
VHF omnidirectional radio range (VOR)	300
VOR/DME	250
Non-directional beacon (NDB)	350
NDB/DME	300
VHF direction finder (VDF)	350

SPO.OP.112 Aerodrome operating minima — circling operations with aeroplanes

- (a) The MDH for a circling operation with aeroplanes shall not be lower than the highest of:
- (1) the published circling OCH for the aeroplane category;
 - (2) the minimum circling height derived from Table 1; or
 - (3) the DH/MDH of the preceding instrument approach procedure.
- (b) The minimum visibility for a circling operation with aeroplanes shall be the highest of:
- (1) the circling visibility for the aeroplane category, if published;
 - (2) the minimum visibility derived from Table 2; or
 - (3) the runway visual range/converted meteorological visibility (RVR/CMV) of the preceding instrument approach procedure.

Table 1				
MDH and minimum visibility for circling vs. aeroplane category				
	Aeroplane category			
	A	B	C	D
MDH (ft)	400	500	600	700
Minimum meteorological visibility (m)	1500	1600	2400	3600

GM1 SPO.OP.112 Aerodrome operating minima — circling operations with aeroplanes

SUPPLEMENTAL INFORMATION

- (a) The purpose of this Guidance Material is to provide operators with supplemental information regarding the application of aerodrome operating minima in relation to circling approaches.
- (b) Conduct of flight — general:
- (1) the MDH and obstacle clearance height (OCH) included in the procedure are referenced to aerodrome elevation;
 - (2) the MDA is referenced to mean sea level;
 - (3) for these procedures, the applicable visibility is the meteorological visibility; and
 - (4) operators should provide tabular guidance of the relationship between height above threshold and the in-flight visibility required to obtain and sustain visual contact during the circling manoeuvre.
- (c) Instrument approach followed by visual manoeuvring (circling) without prescribed tracks:
- (1) When the aeroplane is on the initial instrument approach, before visual reference is stabilised, but not below MDA/H, the aeroplane should follow the corresponding instrument approach procedure until the appropriate instrument MAPt is reached.
 - (2) At the beginning of the level flight phase at or above the MDA/H, the instrument approach track determined by the radio navigation aids, RNAV, RNP, ILS, MLS or GLS should be maintained until the pilot:

- (i) estimates that, in all probability, visual contact with the runway of intended landing or the runway environment will be maintained during the entire circling procedure;
 - (ii) estimates that the aeroplane is within the circling area before commencing circling; and
 - (iii) is able to determine the aeroplane's position in relation to the runway of intended landing with the aid of the appropriate external references.
 - (3) When reaching the published instrument MAPt and the conditions stipulated in (c)(2) are unable to be established by the pilot, a missed approach should be carried out in accordance with that instrument approach procedure.
 - (4) After the aeroplane has left the track of the initial instrument approach, the flight phase outbound from the runway should be limited to an appropriate distance, which is required to align the aeroplane onto the final approach. Such manoeuvres should be conducted to enable the aeroplane:
 - (i) to attain a controlled and stable descent path to the intended landing runway; and
 - (ii) to remain within the circling area and in such way that visual contact with the runway of intended landing or runway environment is maintained at all times.
 - (5) Flight manoeuvres should be carried out at an altitude/height that is not less than the circling MDA/H.
 - (6) Descent below MDA/H should not be initiated until the threshold of the runway to be used has been appropriately identified. The aeroplane should be in a position to continue with a normal rate of descent and land within the touchdown zone.
- (d) Instrument approach followed by a visual manoeuvring (circling) with prescribed track.
- (1) The aeroplane should remain on the initial instrument approach procedure until one of the following is reached:
 - (i) the prescribed divergence point to commence circling on the prescribed track; or
 - (ii) the MAPt.
 - (2) The aeroplane should be established on the instrument approach track determined by the radio navigation aids, RNAV, RNP, ILS, MLS or GLS in level flight at or above the MDA/H at or by the circling manoeuvre divergence point.
 - (3) If the divergence point is reached before the required visual reference is acquired, a missed approach should be initiated not later than the MAPt and completed in accordance with the initial instrument approach procedure.
 - (4) When commencing the prescribed circling manoeuvre at the published divergence point, the subsequent manoeuvres should be conducted to comply with the published routing and published heights/altitudes.
 - (5) Unless otherwise specified, once the aeroplane is established on the prescribed track(s), the published visual reference does not need to be maintained unless:
 - (i) required by the State of the aerodrome; or
 - (ii) the circling MAPt (if published) is reached.
 - (6) If the prescribed circling manoeuvre has a published MAPt and the required visual reference has not been obtained by that point, a missed approach should be executed in accordance with (e)(2) and (e)(3).
 - (7) Subsequent further descent below MDA/H should only commence when the required visual reference has been obtained.

- (8) Unless otherwise specified in the procedure, final descent should not be commenced from MDA/H until the threshold of the intended landing runway has been identified and the aeroplane is in a position to continue with a normal rate of descent to land within the touchdown zone.
- (e) Missed approach
- (1) Missed approach during the instrument procedure prior to circling:
- (i) if the missed approach procedure is required to be flown when the aeroplane is positioned on the instrument approach track defined by the radio navigation aids, RNAV, RNP, ILS, MLS or GLS, and before commencing the circling manoeuvre, the published missed approach for the instrument approach should be followed; or
 - (ii) if the instrument approach procedure is carried out with the aid of an ILS, MLS or an SAp, the MAPt associated with an ILS or MLS procedure without glide path (GP-out procedure) or the SAp, where applicable, should be used.
- (2) If a prescribed missed approach is published for the circling manoeuvre, this overrides the manoeuvres prescribed below.
- (3) If visual reference is lost while circling to land after the aeroplane has departed from the initial instrument approach track, the missed approach specified for that particular instrument approach should be followed. It is expected that the pilot will make an initial climbing turn toward the intended landing runway to a position overhead of the aerodrome where the pilot will establish the aeroplane in a climb on the instrument missed approach segment.
- (4) The aeroplane should not leave the visual manoeuvring (circling) area, which is obstacle protected, unless:
- (i) established on the appropriate missed approach procedure; or
 - (ii) at minimum sector altitude (MSA).
- (5) All turns should be made in the same direction and the aeroplane should remain within the circling protected area while climbing to either:
- (i) the altitude assigned to any published circling missed approach manoeuvre if applicable;
 - (ii) the altitude assigned to the missed approach of the initial instrument approach;
 - (iii) the MSA;
 - (iv) the minimum holding altitude (MHA) applicable for transition to a holding facility or fix, or continue to climb to an MSA; or
 - (v) as directed by ATS.
- When the missed approach procedure is commenced on the ‘downwind’ leg of the circling manoeuvre, an ‘S’ turn may be undertaken to align the aeroplane on the initial instrument approach missed approach path, provided the aeroplane remains within the protected circling area.
- The pilot-in-command should be responsible for ensuring adequate terrain clearance during the above-stipulated manoeuvres, particularly during the execution of a missed approach initiated by ATS.
- (6) Because the circling manoeuvre may be accomplished in more than one direction, different patterns will be required to establish the aeroplane on the prescribed missed approach course depending on its position at the time visual reference is lost. In

particular, all turns are to be in the prescribed direction if this is restricted, e.g. to the west/east (left or right hand) to remain within the protected circling area.

- (7) If a missed approach procedure is published for a particular runway onto which the aeroplane is conducting a circling approach and the aeroplane has commenced a manoeuvre to align with the runway, the missed approach for this direction may be accomplished. The ATS unit should be informed of the intention to fly the published missed approach procedure for that particular runway.
- (8) The pilot-in-command should advise ATS when any missed approach procedure has been commenced, the height/altitude the aeroplane is climbing to and the position the aeroplane is proceeding towards and/or heading the aeroplane is established on.

SPO.OP.113 Aerodrome operating minima — onshore circling operations with helicopters

The MDH for an onshore circling operation with helicopters shall not be lower than 250 ft and the meteorological visibility not less than 800 m.

SPO.OP.115 Departure and approach procedures — aeroplanes and helicopters

- (a) The pilot-in-command shall use the departure and approach procedures established by the State of the aerodrome, if such procedures have been published for the runway or FATO to be used.
- (b) The pilot-in-command may deviate from a published departure route, arrival route or approach procedure:
 - (1) provided obstacle clearance criteria can be observed, full account is taken of the operating conditions and any ATC clearance is adhered to; or
 - (2) when being radar-vectorred by an ATC unit.
- (c) In the case of operations with complex motor-powered aircraft, the final approach segment shall be flown visually or in accordance with the published approach procedures.

SPO.OP.116 Performance-based navigation — aeroplanes and helicopters

The operator shall ensure that, when PBN is required for the route or procedure to be flown:

- (a) the relevant PBN specification is stated in the AFM or other document that has been approved by the certifying authority as part of an airworthiness assessment or is based on such approval; and
- (b) the aircraft is operated in conformance with the relevant navigation specification and limitations in the AFM or other document mentioned above.

AMC1 SPO.OP.116 Performance-based navigation — aeroplanes and helicopters

PBN OPERATIONS

For operations where a navigation specification for performance-based navigation (PBN) has been prescribed and no specific approval is required in accordance with SPA.PBN.100, the operator should:

- (a) establish operating procedures specifying:
 - (1) normal, abnormal and contingency procedures;
 - (2) electronic navigation database management; and
 - (3) relevant entries in the minimum equipment list (MEL);
- (b) specify the flight crew qualification and proficiency constraints and ensure that the training programme for relevant personnel is consistent with the intended operation; and
- (c) ensure continued airworthiness of the area navigation system.

AMC2 SPO.OP.116 Performance-based navigation — aeroplanes and helicopters

MONITORING AND VERIFICATION

- (a) Preflight and general considerations
 - (1) At navigation system initialisation, the flight crew should confirm that the navigation database is current and verify that the aircraft position has been entered correctly, if required.

- (2) The active flight plan, if applicable, should be checked by comparing the charts or other applicable documents with navigation equipment and displays. This includes confirmation of the departing runway and the waypoint sequence, reasonableness of track angles and distances, any altitude or speed constraints, and, where possible, which waypoints are fly-by and which are fly-over. Where relevant, the RF leg arc radii should be confirmed.
 - (3) The flight crew should check that the navigation aids critical to the operation of the intended PBN procedure are available.
 - (4) The flight crew should confirm the navigation aids that should be excluded from the operation, if any.
 - (5) An arrival, approach or departure procedure should not be used if the validity of the procedure in the navigation database has expired.
 - (6) The flight crew should verify that the navigation systems required for the intended operation are operational.
- (b) Departure
- (1) Prior to commencing a take-off on a PBN procedure, the flight crew should check that the indicated aircraft position is consistent with the actual aircraft position at the start of the take-off roll (aeroplanes) or lift-off (helicopters).
 - (2) Where GNSS is used, the signal should be acquired before the take-off roll (aeroplanes) or lift-off (helicopters) commences.
 - (3) Unless automatic updating of the actual departure point is provided, the flight crew should ensure initialisation on the runway or FATO by means of a manual runway threshold or intersection update, as applicable. This is to preclude any inappropriate or inadvertent position shift after take-off.
- (c) Arrival and approach
- (1) The flight crew should verify that the navigation system is operating correctly and the correct arrival procedure and runway (including any applicable transition) are entered and properly depicted.
 - (2) Any published altitude and speed constraints should be observed.
 - (3) The flight crew should check approach procedures (including alternate aerodromes if needed) as extracted by the system (e.g. CDU flight plan page) or presented graphically on the moving map, in order to confirm the correct loading and the reasonableness of the procedure content.
 - (4) Prior to commencing the approach operation (before the IAF), the flight crew should verify the correctness of the loaded procedure by comparison with the appropriate approach charts. This check should include:
 - (i) the waypoint sequence;
 - (ii) reasonableness of the tracks and distances of the approach legs and the accuracy of the inbound course; and
 - (iii) the vertical path angle, if applicable.
- (d) Altimetry settings for RNP APCH operations using Baro VNAV
- (1) Barometric settings
 - (i) The flight crew should set and confirm the correct altimeter setting and check that the two altimeters provide altitude values that do not differ more than 100 ft at the most at or before the FAF.

- (ii) The flight crew should fly the procedure with:
 - (A) a current local altimeter setting source available — a remote or regional altimeter setting source should not be used; and
 - (B) the QNH/QFE, as appropriate, set on the aircraft's altimeters.
- (2) Temperature compensation
 - (i) For RNP APCH operations to LNAV/VNAV minima using Baro VNAV:
 - (A) the flight crew should not commence the approach when the aerodrome temperature is outside the promulgated aerodrome temperature limits for the procedure unless the area navigation system is equipped with approved temperature compensation for the final approach;
 - (B) when the temperature is within promulgated limits, the flight crew should not make compensation to the altitude at the FAF and DA/H; and
 - (C) since only the final approach segment is protected by the promulgated aerodrome temperature limits, the flight crew should consider the effect of temperature on terrain and obstacle clearance in other phases of flight.
 - (ii) For RNP APCH operations to LNAV minima, the flight crew should consider the effect of temperature on terrain and obstacle clearance in all phases of flight, in particular on any step-down fix.
- (e) Sensor and lateral navigation accuracy selection
 - (1) For multi-sensor systems, the flight crew should verify, prior to approach, that the GNSS sensor is used for position computation.
 - (2) Flight crew of aircraft with RNP input selection capability should confirm that the indicated RNP value is appropriate for the PBN operation.

AMC3 SPO.OP.116 Performance-based navigation — aeroplanes and helicopters

MANAGEMENT OF THE NAVIGATION DATABASE

- (a) For RNAV 1, RNAV 2, RNP 1, RNP 2, and RNP APCH, the flight crew should neither insert nor modify waypoints by manual entry into a procedure (departure, arrival or approach) that has been retrieved from the database. User-defined data may be entered and used for waypoint altitude/speed constraints on a procedure where said constraints are not included in the navigation database coding.
- (b) For RNP 4 operations, the flight crew should not modify waypoints that have been retrieved from the database. User-defined data (e.g. for flex-track routes) may be entered and used.
- (c) The lateral and vertical definition of the flight path between the FAF and the missed approach point (MAPt) retrieved from the database should not be revised by the flight crew.

AMC4 SPO.OP.116 Performance-based navigation — aeroplanes and helicopters

DISPLAYS AND AUTOMATION

- (a) For RNAV 1, RNP 1, and RNP APCH operations, the flight crew should use a lateral deviation indicator, and where available, flight director and/or autopilot in lateral navigation mode.
- (b) The appropriate displays should be selected so that the following information can be monitored:
 - (1) the computed desired path;

- (2) aircraft position relative to the lateral path (cross-track deviation) for FTE monitoring; and
 - (3) aircraft position relative to the vertical path (for a 3D operation).
- (c) The flight crew of an aircraft with a lateral deviation indicator (e.g. CDI) should ensure that lateral deviation indicator scaling (full-scale deflection) is suitable for the navigation accuracy associated with the various segments of the procedure.
 - (d) The flight crew should maintain procedure centrelines unless authorised to deviate by ATC or demanded by emergency conditions.
 - (e) Cross-track error/deviation (the difference between the area-navigation-system-computed path and the aircraft-computed position) should normally be limited to $\pm \frac{1}{2}$ time the RNAV/RNP value associated with the procedure. Brief deviations from this standard (e.g. overshoots or undershoots during and immediately after turns) up to a maximum of 1 time the RNAV/RNP value should be allowable.
 - (f) For a 3D approach operation, the flight crew should use a vertical deviation indicator and, where required by AFM limitations, a flight director or autopilot in vertical navigation mode.
 - (g) Deviations below the vertical path should not exceed 75 ft at any time, or half-scale deflection where angular deviation is indicated, and not more than 75 ft above the vertical profile, or half-scale deflection where angular deviation is indicated, at or below 1 000 ft above aerodrome level. The flight crew should execute a missed approach if the vertical deviation exceeds this criterion unless the flight crew has in sight the visual references required to continue the approach.

AMC5 SPO.OP.116 Performance-based navigation — aeroplanes and helicopters

VECTORIZING AND POSITIONING

- (a) ATC tactical interventions in the terminal area may include radar headings, 'direct to' clearances which bypass the initial legs of an approach procedure, interceptions of an initial or intermediate segments of an approach procedure or the insertion of additional waypoints loaded from the database.
- (b) In complying with ATC instructions, the flight crew should be aware of the implications for the navigation system.
- (c) 'Direct to' clearances may be accepted to the IF provided that it is clear to the flight crew that the aircraft will be established on the final approach track at least 2 NM before the FAF.
- (d) 'Direct to' clearance to the FAF should not be acceptable. Modifying the procedure to intercept the final approach track prior to the FAF should be acceptable for radar-vectored arrivals or otherwise only with ATC approval.
- (e) The final approach trajectory should be intercepted no later than the FAF in order for the aircraft to be correctly established on the final approach track before starting the descent (to ensure terrain and obstacle clearance).
- (f) 'Direct to' clearances to a fix that immediately precede an RF leg should not be permitted.
- (g) For parallel offset operations en route in RNP 4 and A-RNP, transitions to and from the offset track should maintain an intercept angle of no more than 45° unless specified otherwise by ATC.

AMC6 SPO.OP.116 Performance-based navigation — aeroplanes and helicopters

ALERTING AND ABORT

- (a) Unless the flight crew has sufficient visual reference to continue the approach operation to a safe landing, an RNP APCH operation should be discontinued if:
 - (1) navigation system failure is annunciated (e.g. warning flag);
 - (2) lateral or vertical deviations exceed the tolerances; and
 - (3) loss of the on-board monitoring and alerting system.
- (b) Discontinuing the approach operation may not be necessary for a multi-sensor navigation system that includes demonstrated RNP capability without GNSS in accordance with the AFM.
- (c) Where vertical guidance is lost while the aircraft is still above 1 000 ft AGL, the flight crew may decide to continue the approach to LNAV minima, when supported by the navigation system.

AMC7 SPO.OP.116 Performance-based navigation — aeroplanes and helicopters

CONTINGENCY PROCEDURES

- (a) The flight crew should make the necessary preparation to revert to a conventional arrival procedure where appropriate. The following conditions should be considered:
 - (1) failure of the navigation system components including navigation sensors, and a failure effecting flight technical error (e.g. failures of the flight director or autopilot);
 - (2) multiple system failures affecting aircraft performance;
 - (3) coasting on inertial sensors beyond a specified time limit; and
 - (4) RAIM (or equivalent) alert or loss of integrity function.
- (b) In the event of loss of PBN capability, the flight crew should invoke contingency procedures and navigate using an alternative means of navigation.
- (c) The flight crew should notify ATC of any problem with PBN capability.
- (d) In the event of communication failure, the flight crew should continue with the operation in accordance with published lost communication procedures.

AMC8 SPO.OP.116 Performance-based navigation — aeroplanes and helicopters

RNAV 10

- (a) Operating procedures and routes should take account of the RNAV 10 time limit declared for the inertial system, if applicable, considering also the effect of weather conditions that could affect flight duration in RNAV 10 airspace.
- (b) The operator may extend RNAV 10 inertial navigation time by position updating. The operator should calculate, using statistically-based typical wind scenarios for each planned route, points at which updates can be made, and the points at which further updates will not be possible.

GM1 SPO.OP.116 Performance-based navigation — aeroplanes and helicopters

DESCRIPTION

- (a) For both, RNP X and RNAV X designations, the 'X' (where stated) refers to the lateral navigation accuracy (total system error) in NM, which is expected to be achieved at least 95 % of the flight

time by the population of aircraft operating within the airspace, route or procedure. For RNP APCH and A-RNP, the lateral navigation accuracy depends on the segment.

- (b) PBN may be required on notified routes, for notified procedures and in notified airspace.

RNAV 10

- (c) For purposes of consistency with the PBN concept, this Regulation is using the designation 'RNAV 10' because this specification does not include on-board performance monitoring and alerting.
- (d) However, it should be noted that many routes still use the designation 'RNP 10' instead of 'RNAV 10'. 'RNP 10' was used as designation before the publication of the fourth edition of ICAO Doc 9613 in 2013. The terms 'RNP 10' and 'RNAV 10' should be considered equivalent.

SPO.OP.120 Noise abatement procedures

The pilot-in-command shall take into account published noise abatement procedures to minimise the effect of aircraft noise while ensuring that safety has priority over noise abatement.

AMC1 SPO.OP.120 Noise abatement procedures

NADP DESIGN — OPERATIONS WITH COMPLEX MOTOR-POWERED AIRCRAFT

- (a) For each aeroplane type two departure procedures should be defined, in accordance with ICAO Doc. 8168 (Procedures for Air Navigation Services, 'PANS-OPS'), Volume I:
 - (1) noise abatement departure procedure one (NADP 1), designed to meet the close-in noise abatement objective; and
 - (2) noise abatement departure procedure two (NADP 2), designed to meet the distant noise abatement objective.
- (b) For each type of NADP (1 and 2), a single climb profile should be specified for use at all aerodromes, which is associated with a single sequence of actions. The NADP 1 and NADP 2 profiles may be identical.

GM1 SPO.OP.120 Noise abatement procedures

TERMINOLOGY — OPERATIONS WITH COMPLEX MOTOR-POWERED AEROPLANES

- (a) 'Climb profile' means in this context the vertical path of the NADP as it results from the pilot's actions (engine power reduction, acceleration, slats/flaps retraction).
- (b) 'Sequence of actions' means the order in which these pilot's actions are done and their timing.

GENERAL

- (c) The rule addresses only the vertical profile of the departure procedure. Lateral track has to comply with the standard instrument departure (SID).

EXAMPLE

- (d) For a given aeroplane type, when establishing the distant NADP, the operator should choose either to reduce power first and then accelerate, or to accelerate first and then wait until slats/flaps are retracted before reducing power. The two methods constitute two different sequences of actions.
- (e) For an aeroplane type, each of the two departure climb profiles may be defined by one sequence of actions (one for close-in, one for distant) and two above aerodrome level (AAL) altitudes/heights. These are:
 - (1) the altitude of the first pilot's action (generally power reduction with or without acceleration). This altitude should not be less than 800 ft AAL; or
 - (2) the altitude of the end of the noise abatement procedure. This altitude should usually not be more than 3 000 ft AAL.
- (f) These two altitudes may be runway specific when the aeroplane flight management system (FMS) has the relevant function that permits the crew to change thrust reduction and/or acceleration altitude/height. If the aeroplane is not FMS equipped or the FMS is not fitted with the relevant function, two fixed heights should be defined and used for each of the two NADPs.

SPO.OP.121 Noise abatement procedures — balloons

The pilot-in-command shall make use of operating procedures, where established, to minimise the effect of heating-system noise while ensuring that safety has priority over noise abatement.

SPO.OP.125 Minimum obstacle clearance altitudes — IFR flights

- (a) The operator shall specify a method to establish minimum flight altitudes that provide the required terrain clearance for all route segments to be flown in IFR.
- (b) The pilot-in-command shall establish minimum flight altitudes for each flight based on this method. The minimum flight altitudes shall not be lower than those published by the State overflown.

AMC1 SPO.OP.125 Minimum obstacle clearance altitudes — IFR flights**GENERAL**

Commercially available information specifying minimum obstacle clearance altitudes may be used.

SPO.OP.130 Fuel and oil supply — aeroplanes

- (a) The pilot-in-command shall only commence a flight if the aeroplane carries sufficient fuel and oil for the following:
- (1) for visual flight rules (VFR) flights:
 - (i) by day, to fly to the aerodrome of intended landing and thereafter to fly for at least 30 minutes at normal cruising altitude; or
 - (ii) by night, to fly to the aerodrome of intended landing and thereafter to fly for at least 45 minutes at normal cruising altitude;
 - (2) for IFR flights:
 - (i) when no destination alternate is required, to fly to the aerodrome of intended landing and thereafter to fly for at least 45 minutes at normal cruising altitude; or
 - (ii) when a destination alternate is required, to fly to the aerodrome of intended landing, to an alternate aerodrome and thereafter to fly for at least 45 minutes at normal cruising altitude.
- (b) In computing the fuel required, including providing for contingency, the following shall be taken into consideration:
- (1) forecast meteorological conditions;
 - (2) anticipated ATC routings and traffic delays;
 - (3) procedures for loss of pressurisation or failure of one engine while en-route, where applicable; and
 - (4) any other condition that may delay the landing of the aeroplane or increase fuel and/or oil consumption.
- (c) Nothing shall preclude amendment of a flight plan in-flight, in order to re-plan the flight to another destination, provided that all requirements can be complied with from the point where the flight is re-planned.

SPO.OP.131 Fuel and oil supply — helicopters

- (a) The pilot-in-command shall only commence a flight if the helicopter carries sufficient fuel and oil for the following:
- (1) for VFR flights:
 - (i) to fly to the aerodrome/operating site of intended landing and thereafter to fly for at least 20 minutes at best-range-speed; or
 - (ii) for VFR flights by day, a reserve fuel of 10 minutes at best-range-speed provided the he/she remains within 25 NM of the aerodrome/operating site of departure; and
 - (2) for IFR flights:
 - (i) when no alternate is required or no weather-permissible alternate aerodrome is available, to fly to the aerodrome/operating site of intended landing, and thereafter to fly for 30 minutes at normal cruising speed at 450 m (1500 ft) above the destination aerodrome/operating site under standard temperature conditions and approach and land; or
 - (ii) when an alternate is required, to fly to and execute an approach and a missed approach at the aerodrome/operating site of intended landing, and thereafter:

- (A) to fly to the specified alternate; and
 - (B) to fly for 30 minutes at normal holding speed at 450 m (1 500 ft) above the alternate aerodrome/operating site under standard temperature conditions and approach and land.
- (b) In computing the fuel required, including providing for contingency, the following shall be taken into consideration:
- (1) forecast meteorological conditions;
 - (2) anticipated ATC routings and traffic delays;
 - (3) failure of one engine while en-route, where applicable; and
 - (4) any other condition that may delay the landing of the aircraft or increase fuel and/or oil consumption.
- (c) Nothing shall preclude amendment of a flight plan in-flight, in order to re-plan the flight to another destination, provided that all requirements can be complied with from the point where the flight is re-planned.

AMC1 SPO.OP.131(a)(1)(ii) Fuel and oil supply — helicopters

REDUCED RESERVE FUEL

- (a) The operator should specify in the SOP:
- (1) the type of activity where such reduced reserve fuel may be used; and
 - (2) methods of reading and calculating the remaining fuel.
- (b) Refuelling facilities should be available at the aerodrome/operating site.

SPO.OP.132 Fuel and ballast supply and planning — balloons

- (a) The pilot-in-command shall only commence a flight if the reserve fuel or ballast is sufficient for 30 minutes of flight.
- (b) Fuel or ballast supply calculations shall be based upon at least the following operating conditions under which the flight is to be conducted:
 - (1) data provided by the balloon manufacturer;
 - (2) anticipated masses;
 - (3) expected meteorological conditions; and
 - (4) air navigation services provider procedures and restrictions.

SPO.OP.135 Safety briefing

- (a) The operator shall ensure that, prior to take-off task specialists are given a briefing on:
 - (1) emergency equipment and procedures;
 - (2) operational procedures associated with the specialised task before each flight or series of flights
- (b) The briefing referred to in (a)(2) may be replaced by an initial and recurrent training programme. In such case the operator shall also define recency requirements.

AMC1 SPO.OP.135 Safety briefing

TASK SPECIALISTS — GENERAL

- (a) The purpose of operational briefing is to ensure that task specialists are familiar with all aspects of the operation, including their responsibilities.
- (b) Such briefing should include, as appropriate:
 - (1) behaviour on the ground and in-flight, including emergency procedures;
 - (2) procedures for boarding and disembarking;
 - (3) procedures for loading and unloading the aircraft;
 - (4) use of doors in normal and emergency operations;
 - (5) use of communication equipment and hand signals;
 - (6) precautions in case of a landing on sloping ground; and
 - (7) in addition to the items listed from (b)(1) to (b)(6) before take-off:
 - (i) location of emergency exits;
 - (ii) restrictions regarding smoking;
 - (iii) restrictions regarding the use of portable electronic equipment; and
 - (iv) stowage of tools and hand baggage.
- (c) The briefing may be given as a verbal presentation or by issuing the appropriate procedures and instructions in written form. Before commencement of the flight, their understanding should be confirmed.

SPO.OP.140 Flight preparation

- (a) Before commencing a flight, the pilot-in-command shall ascertain by every reasonable means available that the space-based facilities, ground and/or water facilities, including communication facilities and navigation aids available and directly required on such flight, for the safe operation of the aircraft, are adequate for the type of operation under which the flight is to be conducted.
- (b) Before commencing a flight, the pilot-in-command shall be familiar with all available meteorological information appropriate to the intended flight. Preparation for a flight away from the vicinity of the place of departure, and for every flight under IFR, shall include:
 - (1) a study of available current weather reports and forecasts; and
 - (2) the planning of an alternative course of action to provide for the eventuality that the flight cannot be completed as planned, because of weather conditions.

SPO.OP.145 Take-off alternate aerodromes — complex motor-powered aeroplanes

- (a) For IFR flights, the pilot-in-command shall specify at least one weather-permissible take-off alternate aerodrome in the flight plan if the weather conditions at the aerodrome of departure are at or below the applicable aerodrome operating minima or it would not be possible to return to the aerodrome of departure for other reasons.
- (b) The take-off alternate aerodrome shall be located within the following distance from the aerodrome of departure:
 - (1) for aeroplanes having two engines, not more than a distance equivalent to a flight time of 1 hour at the single-engine cruise speed in still air standard conditions; and
 - (2) for aeroplanes having three or more engines, not more than a distance equivalent to a flight time of 2 hours at the one-engine-inoperative (OEI) cruise speed according to the AFM in still air standard conditions.
- (c) For an aerodrome to be selected as a take-off alternate aerodrome the available information shall indicate that, at the estimated time of use, the conditions will be at or above the aerodrome operating minima for that operation.

SPO.OP.150 Destination alternate aerodromes — aeroplanes

For IFR flights, the pilot-in-command shall specify at least one weather-permissible destination alternate aerodrome in the flight plan, unless:

- (a) the available current meteorological information indicates that, for the period from 1 hour before until 1 hour after the estimated time of arrival, or from the actual time of departure to 1 hour after the estimated time of arrival, whichever is the shorter period, the approach and landing may be made under visual meteorological conditions (VMC); or
- (b) the place of intended landing is isolated and:
 - (1) an instrument approach procedure is prescribed for the aerodrome of intended landing; and
 - (2) available current meteorological information indicates that the following meteorological conditions will exist from 2 hours before to 2 hours after the estimated time of arrival, or from the actual time of departure to 2 hours after the estimated time of arrival whichever is the shorter period:
 - (i) a cloud base of at least 300 m (1 000 ft) above the minimum associated with the instrument approach procedure; and

- (ii) visibility of at least 5,5 km or of 4 km more than the minimum associated with the procedure.

SPO.OP.151 Destination alternate aerodromes — helicopters

For IFR flights, the pilot-in-command shall specify at least one weather-permissible destination alternate aerodrome in the flight plan, unless:

- (a) an instrument approach procedure is prescribed for the aerodrome of intended landing and the available current meteorological information indicates that the following meteorological conditions will exist from 2 hours before to 2 hours after the estimated time of arrival, or from the actual time of departure to 2 hours after the estimated time of arrival, whichever is the shorter period:
 - (1) a cloud base of at least 120 m (400 ft) above the minimum associated with the instrument approach procedure; and
 - (2) visibility of at least 1 500 m more than the minimum associated with the procedure; or
- (b) the place of intended landing is isolated and:
 - (1) an instrument approach procedure is prescribed for the aerodrome of intended landing;
 - (2) available current meteorological information indicates that the following meteorological conditions will exist from 2 hours before to 2 hours after the estimated time of arrival:
 - (i) the cloud base is at least 120 m (400 ft) above the minimum associated with the instrument approach procedure;
 - (ii) visibility is at least 1 500 m more than the minimum associated with the procedure; and
 - (3) a point of no return (PNR) is determined in case of an offshore destination.

Grey text shall be applicable until 01 July 2018, then deleted

AMC1 SPO.OP.151 Destination alternate aerodromes — helicopters

OFFSHORE ALTERNATE AERODROMES — COMPLEX MOTOR-POWERED HELICOPTERS

- (a) Weather-permissible offshore alternate aerodromes may be selected and specified subject to the following:
 - (1) the offshore alternate aerodrome should only be used after passing a point of no return (PNR). Prior to a PNR, onshore alternate aerodromes should be used;
 - (2) mechanical reliability of critical control systems and critical components should be considered and taken into account when determining the suitability of the alternate aerodrome;
 - (3) one-engine-inoperative (OEI) performance capability should be attainable prior to arrival at the alternate;
 - (4) to the extent possible, deck availability should be guaranteed; and
 - (5) weather information should be reliable and accurate.
- (b) Offshore alternate aerodromes should not be used when it is possible to carry enough fuel to have an onshore alternate aerodrome. Offshore alternate aerodromes should not be used in a hostile environment.
- (c) The landing technique specified in the AFM following control system failure may preclude the nomination of certain helidecks as alternate aerodromes.

This AMC is applicable until 01 July 2018, then deleted.

SPO.OP. 152 Destination alternate aerodromes — instrument approach operations

The pilot-in-command shall ensure that sufficient means are available to navigate and land at the destination aerodrome or at any destination alternate aerodrome in the case of loss of capability for the intended approach and landing operation.

AMC1 SPO.OP.152 Destination aerodromes — instrument approach operations

PBN OPERATIONS

The pilot-in-command should only select an aerodrome as a destination alternate aerodrome if an instrument approach procedure that does not rely on GNSS is available either at that aerodrome or at the destination aerodrome.

GM1 SPO.OP.152 Destination aerodromes — instrument approach operations

INTENT OF AMC1

- (a) The limitation applies only to destination alternate aerodromes for flights when a destination alternate aerodrome is required. A take-off or en route alternate aerodrome with instrument approach procedures relying on GNSS may be planned without restrictions. A destination aerodrome with all instrument approach procedures relying solely on GNSS may be used without a destination alternate aerodrome if the conditions for a flight without a destination alternate aerodrome are met.
- (b) The term 'available' means that the procedure can be used in the planning stage and complies with planning minima requirements.

SPO.OP.155 Refuelling with persons embarking, on board or disembarking

- (a) The aircraft shall not be refuelled with aviation gasoline (AVGAS) or wide-cut type fuel or a mixture of these types of fuel, when persons are embarking, on board or disembarking.
- (b) For all other types of fuel, necessary precautions shall be taken and the aircraft shall be properly manned by qualified personnel ready to initiate and direct an evacuation of the aircraft by the most practical and expeditious means available.

AMC1 SPO.OP.155 Refuelling with persons embarking, on board or disembarking

OPERATIONAL PROCEDURES — AEROPLANES

- (a) Operational procedures should specify that at least the following precautions are taken:
 - (1) One qualified person should remain at a specified location during fuelling operations with persons on board. This qualified person should be capable of handling emergency procedures concerning fire protection and fire-fighting, handling communications and initiating and directing an evacuation.
 - (2) Two-way communication should be established and should remain available by the aeroplane's inter-communication system or other suitable means between the ground crew supervising the refuelling and the qualified personnel on board the aeroplane; the involved personnel should remain within easy reach of the system of communication.
 - (3) Flight crew members and task specialists should be warned that refuelling will take place.
 - (4) 'Fasten seat belts' signs should be off.
 - (5) 'No smoking' signs should be on, together with interior lighting to enable emergency exits to be identified.
 - (6) Task specialists should be instructed to unfasten their seat belts and refrain from smoking.
 - (7) If the presence of fuel vapour is detected inside the aeroplane, or any other hazard arises during refuelling, fuelling should be stopped immediately.
 - (8) The ground area beneath the exits intended for emergency evacuation and slide deployment areas should be kept clear.
 - (9) Provision should be made for a safe and rapid evacuation.

OPERATIONAL PROCEDURES — HELICOPTERS

- (b) Operational procedures should specify that at least the following precautions are taken:
 - (1) Door(s) on the refuelling side of the helicopter remain closed.
 - (2) Door(s) on the non-refuelling side of the helicopter remain open, weather permitting.
 - (3) Firefighting facilities of the appropriate scale be positioned so as to be immediately available in the event of a fire.;
 - (4) Sufficient qualified personnel are on board and be prepared for an immediate emergency evacuation.
 - (5) If the presence of fuel vapour is detected inside the helicopter, or any other hazard arises during refuelling, fuelling should be stopped immediately.
 - (6) The ground area beneath the exits intended for emergency evacuation be kept clear.
 - (7) Provision should be made for a safe and rapid evacuation.

GM1 SPO.OP.155 Refuelling with persons embarking, on board or disembarking

AIRCRAFT REFUELLING PROVISIONS AND GUIDANCE ON SAFE REFUELLING PRACTICES

Provisions concerning aircraft refuelling are contained in Volume I (Aerodrome Design and Operations) of ICAO Annex 14 (Aerodromes), and guidance on safe refuelling practices is contained in Parts 1 and 8 of the ICAO Airport Services Manual (Doc 9137).

SPO.OP.160 Use of headset

Except for balloons, each flight crew member required to be on duty in the flight crew compartment shall wear a headset with boom microphone, or equivalent, and use it as the primary device to communicate with ATS, other crew members and task specialists.

SPO.OP.165 Smoking

The pilot-in-command shall not allow smoking on board or during refuelling or defuelling of the aircraft.

SPO.OP.170 Meteorological conditions

- (a) The pilot-in-command shall only commence or continue a VFR flight if the latest available meteorological information indicates that the weather conditions along the route and at the intended destination at the estimated time of use will be at or above the applicable VFR operating minima.
- (b) The pilot-in-command shall only commence or continue an IFR flight towards the planned destination aerodrome if the latest available meteorological information indicates that, at the estimated time of arrival, the weather conditions at the destination or at least one destination alternate aerodrome are at or above the applicable aerodrome operating minima.
- (c) If a flight contains VFR and IFR segments, the meteorological information referred to in (a) and (b) shall be applicable as far as relevant.

AMC1 SPO.OP.170 Meteorological conditions

EVALUATION OF METEOROLOGICAL CONDITIONS

Pilots should carefully evaluate the available meteorological information relevant to the proposed flight, such as applicable surface observations, winds and temperatures aloft, terminal and area forecasts, air meteorological information reports (AIRMETs), significant meteorological information (SIGMET) and pilot reports. The ultimate decision whether, when, and where to make the flight rests with the pilot-in-command. Pilots should continue to re-evaluate changing weather conditions.

AMC2 SPO.OP.170 Meteorological conditions

APPLICATION OF AERODROME FORECASTS (TAF & TREND)

Where a terminal area forecast (TAF) or meteorological aerodrome or aeronautical report (METAR) with landing forecast (TREND) is used as forecast, the following criteria should be used:

- (a) From the start of a TAF validity period up to the time of applicability of the first subsequent 'FM...' or 'BECMG' or, if no 'FM' or BECMG' is given, up to the end of the validity period of the TAF, the prevailing weather conditions forecast in the initial part of the TAF should be applied.
- (b) From the time of observation of a METAR up to the time of applicability of the first subsequent 'FM...' or 'BECMG' or, if no 'FM' or BECMG' is given, up to the end of the validity period of the TREND, the prevailing weather conditions forecast in the METAR should be applied.
- (c) Following FM (alone) or BECMG AT, any specified change should be applied from the time of the change.
- (d) Following BECMG (alone), BECMG FM, BECMG TL, BECMG FM TL:
 - (1) in the case of deterioration, any specified change should be applied from the start of the change; and

- (2) in the case of improvement, any specified change should be applied from the end of the change.
- (e) In a period indicated by TEMPO (alone), TEMPO FM, TEMPO TL, TEMPO FM TL, PROB30/40 (alone):
 - (1) deteriorations associated with persistent conditions in connection with e.g. haze, mist, fog, dust/sandstorm, continuous precipitation should be applied;
 - (2) deteriorations associated with transient/showery conditions in connection with short-lived weather phenomena, e.g. thunderstorms, showers may be ignored; and
 - (3) improvements should in all cases be disregarded.
- (f) In a period indicated by PROB30/40 TEMPO:
 - (1) deteriorations may be disregarded; and
 - (2) improvements should be disregarded.

Note: Abbreviations used in the context of this AMC are as follows:

FM: from

BECMG: becoming

AT: at

TL: till

TEMPO: temporarily

PROB: probability

GM1 SPO.OP.170 Meteorological conditions

CONTINUATION OF A FLIGHT

In the case of in-flight re-planning, continuation of a flight refers to the point from which a revised flight plan applies.

SPO.OP.175 Ice and other contaminants — ground procedures

- (a) The pilot-in-command shall only commence take-off if the aircraft is clear of any deposit that might adversely affect the performance or controllability of the aircraft, except as permitted in the AFM.
- (b) In the case of operations with complex motor-powered aircraft, the operator shall establish procedures to be followed when ground de-icing and anti-icing and related inspections of the aircraft are necessary to allow the safe operation of the aircraft.

GM1 SPO.OP.175 Ice and other contaminants — ground procedures

TERMINOLOGY

Terms used in the context of de-icing/anti-icing have the meaning defined in the following subparagraphs.

- (a) 'Anti-icing fluid' includes, but is not limited to, the following:
 - (1) Type I fluid if heated to minimum 60 °C at the nozzle;
 - (2) mixture of water and Type I fluid if heated to minimum 60°C at the nozzle;
 - (3) Type II fluid;
 - (4) mixture of water and Type II fluid;
 - (5) Type III fluid;
 - (6) mixture of water and Type III fluid;
 - (7) Type IV fluid;
 - (8) mixture of water and Type IV fluid.

On uncontaminated aircraft surfaces Type II, III and IV anti-icing fluids are normally applied unheated.
- (b) 'Clear ice': a coating of ice, generally clear and smooth, but with some air pockets. It forms on exposed objects, the temperatures of which are at, below or slightly above the freezing temperature, by the freezing of super-cooled drizzle, droplets or raindrops.
- (c) 'Conditions conducive to aircraft icing on the ground' (e.g. freezing fog, freezing precipitation, frost, rain or high humidity (on cold soaked wings), snow or mixed rain and snow).
- (d) 'Contamination', in this context, is understood as being all forms of frozen or semi-frozen moisture, such as frost, snow, slush or ice.
- (e) 'Contamination check': a check of aircraft for contamination to establish the need for de-icing.
- (f) 'De-icing fluid': such fluid includes, but is not limited to, the following:
 - (1) heated water;
 - (2) Type I fluid;
 - (3) mixture of water and Type I fluid;
 - (4) Type II fluid;
 - (5) mixture of water and Type II fluid;
 - (6) Type III fluid;
 - (7) mixture of water and Type III fluid;
 - (8) Type IV fluid;

(9) mixture of water and Type IV fluid.

De-icing fluid is normally applied heated to ensure maximum efficiency.

- (g) ‘De-icing/anti-icing’: this is the combination of de-icing and anti-icing performed in either one or two steps.
- (h) ‘Ground ice detection system (GIDS)’: system used during aircraft ground operations to inform the personnel involved in the operation and/or the flight crew about the presence of frost, ice, snow or slush on the aircraft surfaces.
- (i) ‘Lowest operational use temperature (LOUT)’: the lowest temperature at which a fluid has been tested and certified as acceptable in accordance with the appropriate aerodynamic acceptance test whilst still maintaining a freezing point buffer of not less than:
- (1) 10 C for a Type I de-icing/anti-icing fluid; or
 - (2) 7 C for Type II, III or IV de-icing/anti-icing fluids.
- (j) ‘Post-treatment check’: an external check of the aircraft after de-icing and/or anti-icing treatment accomplished from suitably elevated observation points (e.g. from the de-icing/anti-icing equipment itself or other elevated equipment) to ensure that the aircraft is free from any frost, ice, snow or slush.
- (k) ‘Pre-take-off check’: an assessment normally performed by the flight crew, to validate the applied hold-over time (HoT).
- (l) ‘Pre-take-off contamination check’: a check of the treated surfaces for contamination, performed when the HoT has been exceeded or if any doubt exists regarding the continued effectiveness of the applied anti-icing treatment. It is normally accomplished externally, just before commencement of the take-off run.

ANTI-ICING CODES

- (m) The following are examples of anti-icing codes:
- (1) ‘Type I’ at (start time) — to be used if anti-icing treatment has been performed with a Type I fluid;
 - (2) ‘Type II/100’ at (start time) — to be used if anti-icing treatment has been performed with undiluted Type II fluid;
 - (3) ‘Type II/75’ at (start time) — to be used if anti-icing treatment has been performed with a mixture of 75 % Type II fluid and 25 % water; and
 - (4) ‘Type IV/50’ at (start time) — to be used if anti-icing treatment has been performed with a mixture of 50 % Type IV fluid and 50 % water.
- (n) When a two-step de-icing/anti-icing operation has been carried out, the anti-icing code should be determined by the second step fluid. Fluid brand names may be included, if desired.

GM2 SPO.OP.175 Ice and other contaminants — ground procedures

DE-ICING/ANTI-ICING — PROCEDURES

- (a) De-icing and/or anti-icing procedures should take into account manufacturer’s recommendations, including those that are type-specific, and should cover:
- (1) contamination checks, including detection of clear ice and under-wing frost; limits on the thickness/area of contamination published in the AFM or other manufacturers’ documentation should be followed;

- (2) procedures to be followed if de-icing and/or anti-icing procedures are interrupted or unsuccessful;
 - (3) post-treatment checks;
 - (4) pre-take-off checks;
 - (5) pre-take-off contamination checks;
 - (6) the recording of any incidents relating to de-icing and/or anti-icing; and
 - (7) the responsibilities of all personnel involved in de-icing and/or anti-icing.
- (b) The operator's procedures should ensure the following:
- (1) When aircraft surfaces are contaminated by ice, frost, slush or snow, they are de-iced prior to take-off, according to the prevailing conditions. Removal of contaminants may be performed with mechanical tools, fluids (including hot water), infrared heat or forced air, taking account of aircraft type-specific provisions.
 - (2) Account is taken of the wing skin temperature versus outside air temperature (OAT), as this may affect:
 - (i) the need to carry out aircraft de-icing and/or anti-icing; and/or
 - (ii) the performance of the de-icing/anti-icing fluids.
 - (3) When freezing precipitation occurs or there is a risk of freezing precipitation occurring that would contaminate the surfaces at the time of take-off, aircraft surfaces should be anti-iced. If both de-icing and anti-icing are required, the procedure may be performed in a one or two-step process, depending upon weather conditions, available equipment, available fluids and the desired hold-over time (HoT). One-step de-icing/anti-icing means that de-icing and anti-icing are carried out at the same time, using a mixture of de-icing/anti-icing fluid and water. Two-step de-icing/anti-icing means that de-icing and anti-icing are carried out in two separate steps. The aircraft is first de-iced using heated water only or a heated mixture of de-icing/anti-icing fluid and water. After completion of the de-icing operation a layer of a mixture of de-icing/anti-icing fluid and water, or of de-icing/anti-icing fluid only, is sprayed over the aircraft surfaces. The second step will be applied before the first-step fluid freezes, typically within three minutes and, if necessary, area by area.
 - (4) When an aircraft is anti-iced and a longer HoT is needed/desired, the use of a less diluted Type II or Type IV fluid should be considered.
 - (5) All restrictions relative to OAT and fluid application (including, but not necessarily limited to, temperature and pressure) published by the fluid manufacturer and/or aircraft manufacturer, are followed and procedures, limitations and recommendations to prevent the formation of fluid residues are followed.
 - (6) During conditions conducive to aircraft icing on the ground or after de-icing and/or anti-icing, an aircraft is not dispatched for departure unless it has been given a contamination check or a post-treatment check by a trained and qualified person. This check should cover all treated surfaces of the aircraft and be performed from points offering sufficient accessibility to these parts. To ensure that there is no clear ice on suspect areas, it may be necessary to make a physical check (e.g. tactile).
 - (7) The required entry is made in the technical log.
 - (8) The pilot-in-command continually monitors the environmental situation after the performed treatment. Prior to take-off he/she performs a pre-take-off check, which is an

assessment of whether the applied HoT is still appropriate. This pre-take-off check includes, but is not limited to, factors such as precipitation, wind and OAT.

- (9) If any doubt exists as to whether a deposit may adversely affect the aircraft's performance and/or controllability characteristics, the pilot-in-command should arrange for a pre-take-off contamination check to be performed in order to verify that the aircraft's surfaces are free of contamination. Special methods and/or equipment may be necessary to perform this check, especially at night time or in extremely adverse weather conditions. If this check cannot be performed just before take-off, re-treatment should be applied.
 - (10) When retreatment is necessary, any residue of the previous treatment should be removed and a completely new de-icing/anti-icing treatment should be applied.
 - (11) When a ground ice detection system (GIDS) is used to perform an aircraft surfaces check prior to and/or after a treatment, the use of GIDS by suitably trained personnel should be part of the procedure.
- (c) Special operational considerations
- (1) When using thickened de-icing/anti-icing fluids, the operator should consider a two-step de-icing/anti-icing procedure, the first step preferably with hot water and/or un-thickened fluids.
 - (2) The use of de-icing/anti-icing fluids should be in accordance with the aircraft manufacturer's documentation. This is particularly important for thickened fluids to assure sufficient flow-off during take-off.
 - (3) The operator should comply with any type-specific operational requirement(s), such as an aircraft mass decrease and/or a take-off speed increase associated with a fluid application.
 - (4) The operator should take into account any flight handling procedures (stick force, rotation speed and rate, take-off speed, aircraft attitude etc.) laid down by the aircraft manufacturer when associated with a fluid application.
 - (5) The limitations or handling procedures resulting from (c)(3) and/or (c)(4) should be part of the flight crew pre-take-off briefing.
- (d) Communications
- (1) Before aircraft treatment. When the aircraft is to be treated with the flight crew on board, the flight and personnel involved in the operation should confirm the fluid to be used, the extent of treatment required and any aircraft type-specific procedure(s) to be used. Any other information needed to apply the HoT tables should be exchanged.
 - (2) Anti-icing code. The operator's procedures should include an anti-icing code, which indicates the treatment the aircraft has received. This code provides the flight crew with the minimum details necessary to estimate an HoT and confirms that the aircraft is free of contamination.
 - (3) After treatment. Before reconfiguring or moving the aircraft, the flight crew should receive a confirmation from the personnel involved in the operation that all de-icing and/or anti-icing operations are complete and that all personnel and equipment are clear of the aircraft.
- (e) Hold-over protection
- The operator should publish in the operations manual, when required, the HoTs in the form of a table or a diagram, to account for the various types of ground icing conditions and the different types and concentrations of fluids used. However, the times of protection shown in these tables

are to be used as guidelines only and are normally used in conjunction with the pre-take-off check.

(f) Training

The operator's initial and recurrent de-icing and/or anti-icing training programmes (including communication training) for flight crew and those of its personnel involved in the operation who are involved in de-icing and/or anti-icing should include additional training if any of the following is introduced:

- (1) a new method, procedure and/or technique;
- (2) a new type of fluid and/or equipment; or
- (3) a new type of aircraft.

(g) Contracting

When the operator contracts training on de-icing/anti-icing, the operator should ensure that the contractor complies with the operator's training/qualification procedures, together with any specific procedures in respect of:

- (1) de-icing and/or anti-icing methods and procedures;
- (2) fluids to be used, including precautions for storage and preparation for use;
- (3) specific aircraft requirements (e.g. no-spray areas, propeller/engine de-icing, auxiliary power unit (APU) operation etc.); and
- (4) checking and communications procedures.

(h) Special maintenance considerations

(1) General

The operator should take proper account of the possible side effects of fluid use. Such effects may include, but are not necessarily limited to, dried and/or re-hydrated residues, corrosion and the removal of lubricants.

(2) Special considerations regarding residues of dried fluids

The operator should establish procedures to prevent or detect and remove residues of dried fluid. If necessary the operator should establish appropriate inspection intervals based on the recommendations of the airframe manufacturers and/or the operator's own experience:

(i) Dried fluid residues

Dried fluid residues could occur when surfaces have been treated and the aircraft has not subsequently been flown and has not been subject to precipitation. The fluid may then have dried on the surfaces.

(ii) Re-hydrated fluid residues

Repetitive application of thickened de-icing/anti-icing fluids may lead to the subsequent formation/build-up of a dried residue in aerodynamically quiet areas, such as cavities and gaps. This residue may re-hydrate if exposed to high humidity conditions, precipitation, washing, etc., and increase to many times its original size/volume. This residue will freeze if exposed to conditions at or below 0°C. This may cause moving parts, such as elevators, ailerons, and flap actuating mechanisms to stiffen or jam in-flight. Re-hydrated residues may also form on exterior surfaces, which can reduce lift, increase drag and stall speed. Re-hydrated residues may also collect inside control surface structures and cause clogging of drain holes or

imbalances to flight controls. Residues may also collect in hidden areas, such as around flight control hinges, pulleys, grommets, on cables and in gaps.

- (iii) Operators are strongly recommended to obtain information about the fluid dry-out and re-hydration characteristics from the fluid manufacturers and to select products with optimised characteristics.
- (iv) Additional information should be obtained from fluid manufacturers for handling, storage, application and testing of their products.

GM3 SPO.OP.175 Ice and other contaminants — ground procedures

DE-ICING/ANTI-ICING — BACKGROUND INFORMATION

Further guidance material on this issue is given in the ICAO Manual of Aircraft Ground De-icing/Anti-icing Operations (Doc 9640) (hereinafter referred to as the ICAO Manual of Aircraft Ground De-icing/Anti-icing Operations).

(a) General

- (1) Any deposit of frost, ice, snow or slush on the external surfaces of an aircraft may drastically affect its flying qualities because of reduced aerodynamic lift, increased drag, modified stability and control characteristics. Furthermore, freezing deposits may cause moving parts, such as elevators, ailerons, flap actuating mechanism, etc., to jam and create a potentially hazardous condition. Propeller/engine/APU/systems performance may deteriorate due to the presence of frozen contaminants on blades, intakes and components. Also, engine operation may be seriously affected by the ingestion of snow or ice, thereby causing engine stall or compressor damage. In addition, ice/frost may form on certain external surfaces (e.g. wing upper and lower surfaces, etc.) due to the effects of cold fuel/structures, even in ambient temperatures well above 0°C.
- (2) Procedures established by the operator for de-icing and/or anti-icing are intended to ensure that the aircraft is clear of contamination so that degradation of aerodynamic characteristics or mechanical interference will not occur and, following anti-icing, to maintain the airframe in that condition during the appropriate HoT.
- (3) Under certain meteorological conditions, de-icing and/or anti-icing procedures may be ineffective in providing sufficient protection for continued operations. Examples of these conditions are freezing rain, ice pellets and hail, heavy snow, high wind velocity, fast dropping OAT or any time when freezing precipitation with high water content is present. No HoT guidelines exist for these conditions.
- (4) Material for establishing operational procedures can be found, for example, in:
 - (i) ICAO Annex 3, Meteorological Service for International Air Navigation;
 - (ii) ICAO Manual of Aircraft Ground De-icing/Anti-icing Operations;
 - (iii) International Organization for Standardization (ISO) 11075 Aircraft — De-icing/anti-icing fluids — ISO type I;
 - (iv) ISO 11076 Aircraft — De-icing/anti-icing methods with fluids;
 - (v) ISO 11077 Aerospace — Self-propelled de-icing/anti-icing vehicles — Functional requirements;
 - (vi) ISO 11078 Aircraft — De-icing/anti-icing fluids — ISO types II, III and IV;
 - (vii) Association of European Airlines (AEA) 'Recommendations for de-icing/anti-icing of aircraft on the ground';

- (viii) AEA 'Training recommendations and background information for de-icing/anti-icing of aircraft on the ground';
- (ix) EUROCAE ED-104A Minimum Operational Performance Specification for Ground Ice Detection Systems;
- (x) Society of Automotive Engineers (SAE) AS5681 Minimum Operational Performance Specification for Remote On-Ground Ice Detection Systems;
- (xi) SAE ARP4737 Aircraft — De-icing/anti-icing methods;
- (xii) SAE AMS1424 De-icing/anti-icing Fluid, Aircraft, SAE Type I;
- (xiii) SAE AMS1428 Fluid, Aircraft De-icing/anti-icing, Non-Newtonian, (Pseudoplastic), SAE Types II, III, and IV;
- (xiv) SAE ARP1971 Aircraft De-icing Vehicle — Self-Propelled, Large and Small Capacity;
- (xv) SAE ARP5149 Training Programme Guidelines for De-icing/anti-icing of Aircraft on Ground; and
- (xvi) SAE ARP5646 Quality Program Guidelines for De-icing/anti-icing of Aircraft on the Ground.

(b) Fluids

- (1) Type I fluid: Due to its properties, Type I fluid forms a thin, liquid-wetting film on surfaces to which it is applied which, under certain weather conditions, gives a very limited HoT. With this type of fluid, increasing the concentration of fluid in the fluid/water mix does not provide any extension in HoT.
- (2) Type II and Type IV fluids contain thickeners that enable the fluid to form a thicker liquid-wetting film on surfaces to which it is applied. Generally, this fluid provides a longer HoT than Type I fluids in similar conditions. With this type of fluid, the HoT can be extended by increasing the ratio of fluid in the fluid/water mix.
- (3) Type III fluid is a thickened fluid especially intended for use on aircraft with low rotation speeds.
- (4) Fluids used for de-icing and/or anti-icing should be acceptable to the operator and the aircraft manufacturer. These fluids normally conform to specifications such as SAE AMS1424, SAE AMS1428 or equivalent. Use of non-conforming fluids is not recommended due to their characteristics being unknown. The anti-icing and aerodynamic properties of thickened fluids may be seriously degraded by, for example, inappropriate storage, treatment, application, application equipment and age.

(c) Hold-over protection

- (1) Hold-over protection is achieved by a layer of anti-icing fluid remaining on and protecting aircraft surfaces for a period of time. With a one-step de-icing/anti-icing procedure, the HoT begins at the commencement of de-icing/anti-icing. With a two-step procedure, the HoT begins at the commencement of the second (anti-icing) step. The hold-over protection runs out:
 - (i) at the commencement of the take-off roll (due to aerodynamic shedding of fluid); or
 - (ii) when frozen deposits start to form or accumulate on treated aircraft surfaces, thereby indicating the loss of effectiveness of the fluid.
- (2) The duration of hold-over protection may vary depending on the influence of factors other than those specified in the HoT tables. Guidance should be provided by the operator to take account of such factors, which may include:

-
- (i) atmospheric conditions, e.g. exact type and rate of precipitation, wind direction and velocity, relative humidity and solar radiation; and
 - (ii) the aircraft and its surroundings, such as aircraft component inclination angle, contour and surface roughness, surface temperature, operation in close proximity to other aircraft (jet or propeller blast) and ground equipment and structures.
 - (3) HoTs are not meant to imply that flight is safe in the prevailing conditions if the specified HoT has not been exceeded. Certain meteorological conditions, such as freezing drizzle or freezing rain, may be beyond the certification envelope of the aircraft.
 - (4) References to usable HoT tables may be found in the AEA 'Recommendations for de-icing/anti-icing of aircraft on the ground'.

SPO.OP.176 Ice and other contaminants — flight procedures

- (a) The pilot-in-command shall only commence a flight or intentionally fly into expected or actual icing conditions if the aircraft is certified and equipped to cope with such conditions as referred to in 2.a.5 of Annex IV to Regulation (EC) No 216/2008.
- (b) If icing exceeds the intensity of icing for which the aircraft is certified or if an aircraft not certified for flight in known icing conditions encounters icing, the pilot-in-command shall exit the icing conditions without delay, by a change of level and/or route, and if necessary by declaring an emergency to ATC.
- (c) In the case of operations with complex motor-powered aircraft, the operator shall establish procedures for flights in expected or actual icing conditions.

AMC1 SPO.OP.176 Ice and other contaminants — flight procedures

FLIGHT IN EXPECTED OR ACTUAL ICING CONDITIONS

- (a) The procedures to be established by the operator should take account of the design, the equipment, the configuration of the aircraft and the necessary training. For these reasons, different aircraft types operated by the same company may require the development of different procedures. In every case, the relevant limitations are those that are defined in the AFM and other documents produced by the manufacturer.
- (b) The operator should ensure that the procedures take account of the following:
 - (1) the equipment and instruments that should be serviceable for flight in icing conditions;
 - (2) the limitations on flight in icing conditions for each phase of flight. These limitations may be imposed by the aircraft's de-icing or anti-icing equipment or the necessary performance corrections that have to be made;
 - (3) the criteria the flight crew should use to assess the effect of icing on the performance and/or controllability of the aircraft;
 - (4) the means by which the flight crew detects, by visual cues or the use of the aircraft's ice detection system, that the flight is entering icing conditions; and
 - (5) the action to be taken by the flight crew in a deteriorating situation (which may develop rapidly) resulting in an adverse effect on the performance and/or controllability of the aircraft, due to:
 - (i) the failure of the aircraft's anti-icing or de-icing equipment to control a build-up of ice; and/or
 - (ii) ice build-up on unprotected areas.
- (c) Training for dispatch and flight in expected or actual icing conditions. The content of the operations manual should reflect the training, both conversion and recurrent, that flight crew and all other relevant operational personnel require in order to comply with the procedures for dispatch and flight in icing conditions:
 - (1) instruction on how to recognise, from weather reports or forecasts that are available before flight commences or during flight, the risks of encountering icing conditions along the planned route and on how to modify, as necessary, the departure and in-flight routes or profiles;
 - (2) instruction on the operational and performance limitations or margins;
 - (3) the use of in-flight ice detection, anti-icing and de-icing systems in both normal and abnormal operation; and

- (4) instruction on the differing intensities and forms of ice accretion and the consequent action which should be taken.

SPO.OP.180 Take-off conditions — aeroplanes and helicopters

Before commencing take-off, the pilot-in-command shall be satisfied that:

- (a) according to the information available, the weather at the aerodrome or operating site and the condition of the runway or FATO intended to be used would not prevent a safe take-off and departure; and
- (b) applicable aerodrome operating minima will be complied with.

SPO.OP.181 Take-off conditions — balloons

Before commencing take-off, the pilot-in-command shall be satisfied that, according to the information available, the weather at the operating site or aerodrome will not prevent a safe take-off and departure.

SPO.OP.185 Simulated situations in flight

Unless a task specialist is on-board the aircraft for training, the pilot-in-command shall, when carrying task specialists, not simulate:

- (a) situations that require the application of abnormal or emergency procedures; or
- (b) flight in instrument meteorological conditions (IMC).

SPO.OP.190 In-flight fuel management

- (a) The operator of a complex motor-powered aircraft shall ensure that in-flight fuel checks and fuel management are performed.
- (b) The pilot-in-command shall check at regular intervals that the amount of usable fuel remaining in flight is not less than the fuel required to proceed to a weather-permissible aerodrome or operating site and the planned reserve fuel as required by SPO.OP.130 and SPO.OP.131.

SPO.OP.195 Use of supplemental oxygen

- (a) The operator shall ensure that task specialists and crew members use supplemental oxygen continuously whenever the cabin altitude exceeds 10 000 ft for a period of more than 30 minutes and whenever the cabin altitude exceeds 13 000 ft, unless otherwise approved by the competent authority and in accordance with SOPs.
- (b) Notwithstanding (a) and except for parachute operations, short excursions of a specified duration above 13 000 ft without using supplemental oxygen on other-than complex aeroplanes and helicopters may be undertaken with a prior approval of the competent authority based on the consideration of the following:
 - (1) the duration of the excursion above 13 000 ft is not more than 10 minutes or, if needed for a longer period, the time strictly necessary to the accomplishment of the specialised task;
 - (2) the flight is not conducted above 16 000 ft;
 - (3) the safety briefing in accordance with SPO.OP.135 includes adequate information to crew members and tasks specialists on the effects of hypoxia;
 - (4) SOPs for the concerned operation reflecting (1), (2) and (3);
 - (5) the previous experience of the operator in conducting operations above 13 000 ft without using supplemental oxygen;

- (6) the individual experience of crew members and task specialists and their physiological adaptation to high altitudes; and
- (7) the altitude of the base where the operator is established or the operations are conducted from.

SPO.OP.200 Ground proximity detection

- (a) When undue proximity to the ground is detected by a flight crew member or by a ground proximity warning system, the pilot flying shall take corrective action immediately in order to establish safe flight conditions.
- (b) The ground proximity warning system may be disabled during those specialised tasks, which by their nature require the aircraft to be operated within a distance from the ground below that which would trigger the ground proximity warning system.

GM1 SPO.OP.200 Ground proximity detection

GUIDANCE MATERIAL FOR TERRAIN AWARENESS WARNING SYSTEM (TAWS) FLIGHT CREW TRAINING PROGRAMMES

- (a) Introduction
 - (1) This GM contains performance-based training objectives for TAWS flight crew training.
 - (2) The training objectives cover five areas: theory of operation; pre-flight operations; general in-flight operations; response to TAWS cautions; response to TAWS warnings.
 - (3) The term 'TAWS' in this GM means a ground proximity warning system (GPWS) enhanced by a forward-looking terrain avoidance function. Alerts include both cautions and warnings.
 - (4) The content of this GM is intended to assist operators who are producing training programmes. The information it contains has not been tailored to any specific aircraft or TAWS equipment, but highlights features that are typically available where such systems are installed. It is the responsibility of the individual operator to determine the applicability of the content of this Guidance Material to each aircraft and TAWS equipment installed and their operation. Operators should refer to the AFM and/or aircraft/flight crew operating manual (A/FCOM), or similar documents, for information applicable to specific configurations. If there should be any conflict between the content of this Guidance Material and that published in the other documents described above, then the information contained in the AFM or A/FCOM will take precedence.
- (b) Scope
 - (1) The scope of this GM is designed to identify training objectives in the areas of: academic training; manoeuvre training; initial evaluation; recurrent qualification. Under each of these four areas, the training material has been separated into those items that are considered essential training items and those that are considered to be desirable. In each area, objectives and acceptable performance criteria are defined.
 - (2) No attempt is made to define how the training programme should be implemented. Instead, objectives are established to define the knowledge that a pilot operating a TAWS is expected to possess and the performance expected from a pilot who has completed TAWS training. However, the guidelines do indicate those areas in which the pilot receiving the training should demonstrate his/her understanding, or performance, using a real-time, interactive training device, i.e. a flight simulator. Where appropriate, notes

are included within the performance criteria that amplify or clarify the material addressed by the training objective.

(c) Performance-based training objectives

(1) TAWS academic training

(i) This training is typically conducted in a classroom environment. The knowledge demonstrations specified in this section may be completed through the successful completion of written tests or by providing correct responses to non-real-time computer-based training (CBT) questions.

(ii) Theory of operation. The pilot should demonstrate an understanding of TAWS operation and the criteria used for issuing cautions and warnings. This training should address system operation. Objective: to demonstrate knowledge of how a TAWS functions. Criteria: the pilot should demonstrate an understanding of the following functions:

(A) Surveillance

(a) The GPWS computer processes data supplied from an air data computer, a radio altimeter, an instrument landing system (ILS)/microwave landing system (MLS)/multi-mode (MM) receiver, a roll attitude sensor, and actual position of the surfaces and of the landing gear.

(b) The forward-looking terrain avoidance function utilises an accurate source of known aircraft position, such as that which may be provided by a flight management system (FMS) or global positioning system (GPS), or an electronic terrain database. The source and scope of the terrain, obstacle and airport data, and features such as the terrain clearance floor, the runway picker, and geometric altitude (where provided), should all be described.

(c) Displays required to deliver TAWS outputs include a loudspeaker for voice announcements, visual alerts (typically amber and red lights) and a terrain awareness display (that may be combined with other displays). In addition, means should be provided for indicating the status of the TAWS and any partial or total failures that may occur.

(B) Terrain avoidance. Outputs from the TAWS computer provide visual and audio synthetic voice cautions and warnings to alert the flight crew about potential conflicts with terrain and obstacles.

(C) Alert thresholds. Objective: to demonstrate knowledge of the criteria for issuing cautions and warnings. Criteria: the pilot should be able to demonstrate an understanding of the methodology used by a TAWS to issue cautions and alerts and the general criteria for the issuance of these alerts, including:

(a) basic GPWS alerting modes specified in the ICAO standard:

Mode 1: excessive sink rate;

Mode 2: excessive terrain closure rate;

Mode 3: descent after take-off or missed approach;

Mode 4: unsafe proximity to terrain; and

Mode 5: descent below ILS glide slope (caution only);

- (b) an additional, optional alert mode:
 - Mode 6: radio altitude call-out (information only); and
 - (c) TAWS cautions and warnings that alert the flight crew to obstacles and terrain ahead of the aircraft in line with or adjacent to its projected flight path (forward-looking terrain avoidance (FLTA) and premature descent alert (PDA) functions).
- (D) TAWS limitations. Objective: to verify that the pilot is aware of the limitations of TAWS. Criteria: the pilot should demonstrate knowledge and an understanding of TAWS limitations identified by the manufacturer for the equipment model installed, such as:
- (a) navigation should not be predicated on the use of the terrain display;
 - (b) unless geometric altitude data is provided, use of predictive TAWS functions is prohibited when altimeter subscale settings display 'QFE' (atmospheric pressure at aerodrome elevation/runway threshold);
 - (c) nuisance alerts can be issued if the aerodrome of intended landing is not included in the TAWS airport database;
 - (d) in cold weather operations, corrective procedures should be implemented by the pilot unless the TAWS has in-built compensation, such as geometric altitude data;
 - (e) loss of input data to the TAWS computer could result in partial or total loss of functionality. Where means exist to inform the flight crew that functionality has been degraded, this should be known and the consequences understood;
 - (f) radio signals not associated with the intended flight profile (e.g. ILS glide path transmissions from an adjacent runway) may cause false alerts;
 - (g) inaccurate or low accuracy aircraft position data could lead to false or non-annunciation of terrain or obstacles ahead of the aircraft; and
 - (h) minimum equipment list (MEL) restrictions should be applied in the event of the TAWS becoming partially or completely unserviceable. (It should be noted that basic GPWS has no forward-looking capability.)
- (E) TAWS inhibits. Objective: to verify that the pilot is aware of the conditions under which certain functions of a TAWS are inhibited. Criteria: the pilot should demonstrate knowledge and an understanding of the various TAWS inhibits, including the following means of:
- (a) silencing voice alerts;
 - (b) inhibiting ILS glide path signals (as may be required when executing an ILS back beam approach);
 - (c) inhibiting flap position sensors (as may be required when executing an approach with the flaps not in a normal position for landing);
 - (d) inhibiting the FLTA and PDA functions; and
 - (e) selecting or deselecting the display of terrain information, together with appropriate annunciation of the status of each selection.

- (2) Operating procedures. The pilot should demonstrate the knowledge required to operate TAWS avionics and to interpret the information presented by a TAWS. This training should address the following topics:
- (i) Use of controls. Objective: to verify that the pilot can properly operate all TAWS controls and inhibits. Criteria: the pilot should demonstrate the proper use of controls, including the following means by which:
 - (A) before flight, any equipment self-test functions can be initiated;
 - (B) TAWS information can be selected for display; and
 - (C) all TAWS inhibits can be operated and what the consequent annunciations mean with regard to loss of functionality.
 - (ii) Display interpretation. Objective: to verify that the pilot understands the meaning of all information that can be annunciated or displayed by a TAWS. Criteria: the pilot should demonstrate the ability to properly interpret information annunciated or displayed by a TAWS, including the following:
 - (A) knowledge of all visual and aural indications that may be seen or heard;
 - (B) response required on receipt of a caution;
 - (C) response required on receipt of a warning; and
 - (D) response required on receipt of a notification that partial or total failure of the TAWS has occurred (including annunciation that the present aircraft position is of low accuracy).
 - (iii) Use of basic GPWS or use of the FLTA function only. Objective: to verify that the pilot understands what functionality will remain following loss of the GPWS or of the FLTA function. Criteria: the pilot should demonstrate knowledge of how to recognise the following:
 - (A) un-commanded loss of the GPWS function, or how to isolate this function and how to recognise the level of the remaining controlled flight into terrain (CFIT) protection (essentially, this is the FLTA function); and
 - (B) un-commanded loss of the FLTA function, or how to isolate this function and how to recognise the level of the remaining CFIT protection (essentially, this is the basic GPWS).
 - (iv) Crew coordination. Objective: to verify that the pilot adequately briefs other flight crew members on how TAWS alerts will be handled. Criteria: the pilot should demonstrate that the pre-flight briefing addresses procedures that will be used in preparation for responding to TAWS cautions and warnings, including the following:
 - (A) the action to be taken, and by whom, in the event that a TAWS caution and/or warning is issued; and
 - (B) how multi-function displays will be used to depict TAWS information at take-off, in the cruise and for the descent, approach, landing (and any missed approach). This will be in accordance with procedures specified by the operator, who will recognise that it may be more desirable that other data is displayed at certain phases of flight and that the terrain display has an automatic 'pop-up' mode in the event that an alert is issued.

- (v) Reporting rules. Objective: to verify that the pilot is aware of the rules for reporting alerts to the controller and other authorities. Criteria: the pilot should demonstrate knowledge of the following:
 - (A) when, following recovery from a TAWS alert or caution, a transmission of information should be made to the appropriate ATC unit; and
 - (B) the type of written report that is required, how it is to be compiled and whether any cross-reference should be made in the aircraft technical log and/or voyage report (in accordance with procedures specified by the operator), following a flight in which the aircraft flight path has been modified in response to a TAWS alert, or if any part of the equipment appears not to have functioned correctly.
- (vi) Alert thresholds. Objective: to demonstrate knowledge of the criteria for issuing cautions and warnings. Criteria: the pilot should be able to demonstrate an understanding of the methodology used by a TAWS to issue cautions and warnings and the general criteria for the issuance of these alerts, including awareness of the following:
 - (A) modes associated with basic GPWS, including the input data associated with each; and
 - (B) visual and aural annunciations that can be issued by TAWS and how to identify which are cautions and which are warnings.
- (3) TAWS manoeuvre training. The pilot should demonstrate the knowledge required to respond correctly to TAWS cautions and warnings. This training should address the following topics:
 - (i) Response to cautions:
 - (A) Objective: to verify that the pilot properly interprets and responds to cautions. Criteria: the pilot should demonstrate an understanding of the need, without delay:
 - (a) to initiate action required to correct the condition that has caused the TAWS to issue the caution and to be prepared to respond to a warning, if this should follow; and
 - (b) if a warning does not follow the caution, to notify the controller of the new position, heading and/or altitude/flight level of the aircraft, and what the pilot-in-command intends to do next.
 - (B) The correct response to a caution might require the pilot to:
 - (a) reduce a rate of descent and/or to initiate a climb;
 - (b) regain an ILS glide path from below, or to inhibit a glide path signal if an ILS is not being flown;
 - (c) select more flap, or to inhibit a flap sensor if the landing is being conducted with the intent that the normal flap setting will not be used;
 - (d) select gear down; and/or
 - (e) initiate a turn away from the terrain or obstacle ahead and towards an area free of such obstructions if a forward-looking terrain display indicates that this would be a good solution and the entire manoeuvre can be carried out in clear visual conditions.

- (ii) Response to warnings. Objective: to verify that the pilot properly interprets and responds to warnings. Criteria: the pilot should demonstrate an understanding of the following:
 - (A) The need, without delay, to initiate a climb in the manner specified by the operator.
 - (B) The need, without delay, to maintain the climb until visual verification can be made that the aircraft will clear the terrain or obstacle ahead or until above the appropriate sector safe altitude (if certain about the location of the aircraft with respect to terrain) even if the TAWS warning stops. If, subsequently, the aircraft climbs up through the sector safe altitude, but the visibility does not allow the flight crew to confirm that the terrain hazard has ended, checks should be made to verify the location of the aircraft and to confirm that the altimeter subscale settings are correct.
 - (C) When workload permits that, the flight crew should notify the air traffic controller of the new position and altitude/flight level and what the pilot-in-command intends to do next.
 - (D) That the manner in which the climb is made should reflect the type of aircraft and the method specified by the aircraft manufacturer (which should be reflected in the operations manual) for performing the escape manoeuvre. Essential aspects will include the need for an increase in pitch attitude, selection of maximum thrust, confirmation that external sources of drag (e.g. spoilers/speed brakes) are retracted and respect of the stick shaker or other indication of eroded stall margin.
 - (E) That TAWS warnings should never be ignored. However, the pilot's response may be limited to that which is appropriate for a caution, only if:
 - (a) the aircraft is being operated by day in clear, visual conditions; and
 - (b) it is immediately clear to the pilot that the aircraft is in no danger in respect of its configuration, proximity to terrain or current flight path.
- (4) TAWS initial evaluation:
 - (i) The flight crew member's understanding of the academic training items should be assessed by means of a written test.
 - (ii) The flight crew member's understanding of the manoeuvre training items should be assessed in a flight simulation training device (FSTD) equipped with TAWS visual and aural displays and inhibit selectors similar in appearance and operation to those in the aircraft that the pilot will fly. The results should be assessed by a flight simulation training instructor, synthetic flight examiner, type rating instructor or type rating examiner.
 - (iii) The range of scenarios should be designed to give confidence that proper and timely responses to TAWS cautions and warnings will result in the aircraft avoiding a CFIT accident. To achieve this objective, the pilot should demonstrate taking the correct action to prevent a caution developing into a warning and, separately, the escape manoeuvre needed in response to a warning. These demonstrations should take place when the external visibility is zero, though there is much to be learnt if, initially, the training is given in 'mountainous' or 'hilly' terrain with clear visibility. This training should comprise a sequence of scenarios, rather than be included in line orientated flight training (LOFT).

- (iv) A record should be made, after the pilot has demonstrated competence, of the scenarios that were practised.
- (5) TAWS recurrent training:
- (i) TAWS recurrent training ensures that pilots maintain the appropriate TAWS knowledge and skills. In particular, it reminds pilots of the need to act promptly in response to cautions and warnings and of the unusual attitude associated with flying the escape manoeuvre.
 - (ii) An essential item of recurrent training is the discussion of any significant issues and operational concerns that have been identified by the operator. Recurrent training should also address changes to TAWS logic, parameters or procedures and to any unique TAWS characteristics of which pilots should be aware.
- (6) Reporting procedures:
- (i) Verbal reports. Verbal reports should be made promptly to the appropriate ATC unit:
 - (A) whenever any manoeuvre has caused the aircraft to deviate from an air traffic clearance;
 - (B) when, following a manoeuvre that has caused the aircraft to deviate from an air traffic clearance, the aircraft has returned to a flight path that complies with the clearance; and/or
 - (C) when an air traffic control unit issues instructions that, if followed, would cause the pilot to manoeuvre the aircraft towards terrain or obstacle or it would appear from the display that a potential CFIT occurrence is likely to result.
 - (ii) Written reports. Written reports should be submitted in accordance with the operator's occurrence reporting scheme and they should also be recorded in the aircraft technical log:
 - (A) whenever the aircraft flight path has been modified in response to a TAWS alert (false, nuisance or genuine);
 - (B) whenever a TAWS alert has been issued and is believed to have been false; and/or
 - (C) if it is believed that a TAWS alert should have been issued, but was not.
 - (iii) Within this GM, and with regard to reports:
 - (A) the term 'false' means that the TAWS issued an alert that could not possibly be justified by the position of the aircraft in respect to terrain and it is probable that a fault or failure in the system (equipment and/or input data) was the cause;
 - (B) the term 'nuisance' means that the TAWS issued an alert that was appropriate, but was not needed because the flight crew could determine by independent means that the flight path was, at that time, safe;
 - (C) the term 'genuine' means that the TAWS issued an alert that was both appropriate and necessary;
 - (D) the report terms described above are only meant to be assessed after the occurrence is over, to facilitate subsequent analysis, the adequacy of the equipment and the programmes it contains. The intention is not for the flight

crew to attempt to classify an alert into any of these three categories when visual and/or aural cautions or warnings are annunciated.

SPO.OP.205 Airborne collision avoidance system (ACAS)

- (a) The operator shall establish operational procedures and training programmes when ACAS is installed and serviceable so that the flight crew is appropriately trained in the avoidance of collisions and competent in the use of ACAS II equipment.
- (b) The ACAS II may be disabled during those specialised tasks, which by their nature require the aircraft to be operated within a distance from each other below that which would trigger the ACAS.

GM1 SPO.OP.205 Airborne collision avoidance system (ACAS)

GENERAL

- (a) The ACAS operational procedures and training programmes established by the operator should take into account this Guidance Material. It incorporates advice contained in:
 - (1) ICAO Annex 10, Volume IV;
 - (2) ICAO PANS-OPS, Volume 1;
 - (3) ICAO PANS-ATM; and
 - (4) ICAO guidance material 'ACAS Performance-Based Training Objectives' (published under Attachment E of State Letter AN 7/1.3.7.2-97/77).
- (b) Additional guidance material on ACAS may be referred to, including information available from such sources as EUROCONTROL.

ACAS FLIGHT CREW TRAINING

- (c) During the implementation of ACAS, several operational issues were identified that had been attributed to deficiencies in flight crew training programmes. As a result, the issue of flight crew training has been discussed within the ICAO, which has developed guidelines for operators to use when designing training programmes.
- (d) This Guidance Material contains performance-based training objectives for ACAS II flight crew training. Information contained here related to traffic advisories (TAs) is also applicable to ACAS I and ACAS II users. The training objectives cover five areas: theory of operation; pre-flight operations; general in-flight operations; response to TAs; and response to resolution advisories (RAs).
- (e) The information provided is valid for version 7 and 7.1 (ACAS II). Where differences arise, these are identified.
- (f) The performance-based training objectives are further divided into the areas of: academic training; manoeuvre training; initial evaluation and recurrent qualification. Under each of these four areas, the training material has been separated into those items which are considered essential training items and those which are considered desirable. In each area, objectives and acceptable performance criteria are defined.
- (g) ACAS academic training
 - (1) This training is typically conducted in a classroom environment. The knowledge demonstrations specified in this section may be completed through the successful completion of written tests or through providing correct responses to non-real-time computer-based training (CBT) questions.
 - (2) Essential items

- (i) Theory of operation. The flight crew member should demonstrate an understanding of ACAS II operation and the criteria used for issuing TAs and RAs. This training should address the following topics:

(A) System operation

Objective: to demonstrate knowledge of how ACAS functions.

Criteria: the flight crew member should demonstrate an understanding of the following functions:

(a) Surveillance

- (1) ACAS interrogates other transponder-equipped aircraft within a nominal range of 14 NM.
- (2) ACAS surveillance range can be reduced in geographic areas with a large number of ground interrogators and/or ACAS II-equipped aircraft.
- (3) If the operator's ACAS implementation provides for the use of the Mode S extended squitter, the normal surveillance range may be increased beyond the nominal 14 NM. However, this information is not used for collision avoidance purposes.

(b) Collision avoidance

- (1) TAs can be issued against any transponder-equipped aircraft that responds to the ICAO Mode C interrogations, even if the aircraft does not have altitude reporting capability.
- (2) RAs can be issued only against aircraft that are reporting altitude and in the vertical plane only.
- (3) RAs issued against an ACAS-equipped intruder are co-ordinated to ensure complementary RAs are issued.
- (4) Failure to respond to an RA deprives own aircraft of the collision protection provided by own ACAS.
- (5) Additionally, in ACAS-ACAS encounters, failure to respond to an RA also restricts the choices available to the other aircraft's ACAS and thus renders the other aircraft's ACAS less effective than if own aircraft were not ACAS equipped.

(B) Advisory thresholds

Objective: to demonstrate knowledge of the criteria for issuing TAs and RAs.

Criteria: the flight crew member should demonstrate an understanding of the methodology used by ACAS to issue TAs and RAs and the general criteria for the issuance of these advisories, including the following:

- (a) ACAS advisories are based on time to closest point of approach (CPA) rather than distance. The time should be short and vertical separation should be small, or projected to be small, before an advisory can be issued. The separation standards provided by ATS are different from the miss distances against which ACAS issues alerts.
- (b) Thresholds for issuing a TA or an RA vary with altitude. The thresholds are larger at higher altitudes.

- (c) A TA occurs from 15 to 48 seconds and an RA from 15 to 35 seconds before the projected CPA.
 - (d) RAs are chosen to provide the desired vertical miss distance at CPA. As a result, RAs can instruct a climb or descent through the intruder aircraft's altitude.
- (C) ACAS limitations
- Objective: to verify that the flight crew member is aware of the limitations of ACAS.
- Criteria: the flight crew member should demonstrate knowledge and understanding of ACAS limitations, including the following:
- (a) ACAS will neither track nor display non-transponder-equipped aircraft, nor aircraft not responding to ACAS Mode C interrogations.
 - (b) ACAS will automatically fail if the input from the aircraft's barometric altimeter, radio altimeter or transponder is lost.
 - (1) In some installations, the loss of information from other on-board systems such as an inertial reference system (IRS) or attitude heading reference system (AHRS) may result in an ACAS failure. Individual operators should ensure that their flight crews are aware of the types of failure which will result in an ACAS failure.
 - (2) ACAS may react in an improper manner when false altitude information is provided to own ACAS or transmitted by another aircraft. Individual operators should ensure that their flight crew are aware of the types of unsafe conditions which can arise. Flight crew members should ensure that when they are advised, if their own aircraft is transmitting false altitude reports, an alternative altitude reporting source is selected, or altitude reporting is switched off.
 - (c) Some aeroplanes within 380 ft above ground level (AGL) (nominal value) are deemed to be 'on ground' and will not be displayed. If ACAS is able to determine an aircraft below this altitude is airborne, it will be displayed.
 - (d) ACAS may not display all proximate transponder-equipped aircraft in areas of high density traffic.
 - (e) The bearing displayed by ACAS is not sufficiently accurate to support the initiation of horizontal manoeuvres based solely on the traffic display.
 - (f) ACAS will neither track nor display intruders with a vertical speed in excess of 10 000 ft/min. In addition, the design implementation may result in some short-term errors in the tracked vertical speed of an intruder during periods of high vertical acceleration by the intruder.
 - (g) Ground proximity warning systems/ground collision avoidance systems (GPWSs/GCASs) warnings and wind shear warnings take precedence over ACAS advisories. When either a GPWS/GCAS or wind shear warning is active, ACAS aural annunciations will be inhibited and ACAS will automatically switch to the 'TA only' mode of operation.

(D) ACAS inhibits

Objective: to verify that the flight crew member is aware of the conditions under which certain functions of ACAS are inhibited.

Criteria: the flight crew member should demonstrate knowledge and understanding of the various ACAS inhibits, including the following:

- (a) 'Increase Descent' RAs are inhibited below 1 450 ft AGL.
- (b) 'Descend' RAs are inhibited below 1 100 ft AGL.
- (c) All RAs are inhibited below 1 000 ft AGL.
- (d) All TA aural annunciations are inhibited below 500 ft AGL.
- (e) Altitude and configuration under which 'Climb' and 'Increase Climb' RAs are inhibited. ACAS can still issue 'Climb' and 'Increase Climb' RAs when operating at the aeroplane's certified ceiling. (In some aircraft types, 'Climb' or 'Increase Climb' RAs are never inhibited.)

(ii) Operating procedures

The flight crew member should demonstrate the knowledge required to operate the ACAS avionics and interpret the information presented by ACAS. This training should address the following:

(A) Use of controls

Objective: to verify that the pilot can properly operate all ACAS and display controls.

Criteria: demonstrate the proper use of controls, including the following:

- (a) Aircraft configuration required to initiate a self-test.
- (b) Steps required to initiate a self-test.
- (c) Recognising when the self-test was successful and when it was unsuccessful. When the self-test is unsuccessful, recognising the reason for the failure and, if possible, correcting the problem.
- (d) Recommended usage of range selection. Low ranges are used in the terminal area and the higher display ranges are used in the en-route environment and in the transition between the terminal and en-route environment.
- (e) Recognising that the configuration of the display does not affect the ACAS surveillance volume.
- (f) Selection of lower ranges when an advisory is issued, to increase display resolution.
- (g) Proper configuration to display the appropriate ACAS information without eliminating the display of other needed information.
- (h) If available, recommended usage of the above/below mode selector. The above mode should be used during climb and the below mode should be used during descent.
- (i) If available, proper selection of the display of absolute or relative altitude and the limitations of using this display if a barometric correction is not provided to ACAS.

(B) Display interpretation

Objective: to verify that the flight crew member understands the meaning of all information that can be displayed by ACAS. The wide variety of display implementations require the tailoring of some criteria. When the training programme is developed, these criteria should be expanded to cover details for the operator's specific display implementation.

Criteria: the flight crew member should demonstrate the ability to properly interpret information displayed by ACAS, including the following:

- (a) Other traffic, i.e. traffic within the selected display range that is not proximate traffic, or causing a TA or RA to be issued.
 - (b) Proximate traffic, i.e. traffic that is within 6 NM and $\pm 1\,200$ ft.
 - (c) Non-altitude reporting traffic.
 - (d) No bearing TAs and RAs.
 - (e) Off-scale TAs and RAs: the selected range should be changed to ensure that all available information on the intruder is displayed.
 - (f) TAs: the minimum available display range that allows the traffic to be displayed should be selected, to provide the maximum display resolution.
 - (g) RAs (traffic display): the minimum available display range of the traffic display that allows the traffic to be displayed should be selected, to provide the maximum display resolution.
 - (h) RAs (RA display): flight crew members should demonstrate knowledge of the meaning of the red and green areas or the meaning of pitch or flight path angle cues displayed on the RA display. Flight crew members should also demonstrate an understanding of the RA display limitations, i.e. if a vertical speed tape is used and the range of the tape is less than 2 500 ft/min, an increase rate RA cannot be properly displayed.
 - (i) If appropriate, awareness that navigation displays oriented on 'Track-Up' may require a flight crew member to make a mental adjustment for drift angle when assessing the bearing of proximate traffic.
- (C) Use of the TA only mode

Objective: to verify that a flight crew member understands the appropriate times to select the TA only mode of operation and the limitations associated with using this mode.

Criteria: the flight crew member should demonstrate the following:

- (a) Knowledge of the operator's guidance for the use of TA only.
- (b) Reasons for using this mode. If TA only is not selected when an airport is conducting simultaneous operations from parallel runways separated by less than 1 200 ft, and to some intersecting runways, RAs can be expected. If, for any reason, TA only is not selected and an RA is received in these situations, the response should comply with the operator's approved procedures.
- (c) All TA aural annunciations are inhibited below 500 ft AGL. As a result, TAs issued below 500 ft AGL may not be noticed unless the TA display is included in the routine instrument scan.

(D) Crew coordination

Objective: to verify that the flight crew member understands how ACAS advisories will be handled.

Criteria: the flight crew member should demonstrate knowledge of the crew procedures that should be used when responding to TAs and RAs, including the following:

- (a) task sharing between the pilot flying and the pilot monitoring;
- (b) expected call-outs; and
- (c) communications with ATC.

(E) Phraseology rules

Objective: to verify that the flight crew member is aware of the rules for reporting RAs to the controller.

Criteria: the flight crew member should demonstrate the following:

- (a) the use of the phraseology contained in ICAO PANS-OPS;
- (b) an understanding of the procedures contained in ICAO PANS-ATM and ICAO Annex 2; and
- (c) the understanding that verbal reports should be made promptly to the appropriate ATC unit:
 - (1) whenever any manoeuvre has caused the aeroplane to deviate from an air traffic clearance;
 - (2) when, subsequent to a manoeuvre that has caused the aeroplane to deviate from an air traffic clearance, the aeroplane has returned to a flight path that complies with the clearance; and/or
 - (3) when air traffic issue instructions that, if followed, would cause the crew to manoeuvre the aircraft contrary to an RA with which they are complying.

(F) Reporting rules

Objective: to verify that the flight crew member is aware of the rules for reporting RAs to the operator.

Criteria: the flight crew member should demonstrate knowledge of where information can be obtained regarding the need for making written reports to various States when an RA is issued. Various States have different reporting rules and the material available to the flight crew member should be tailored to the operator's operating environment. This responsibility is satisfied by the flight crew member reporting to the operator according to the applicable reporting rules.

(3) Non-essential items: advisory thresholds

Objective: to demonstrate knowledge of the criteria for issuing TAs and RAs.

Criteria: the flight crew member should demonstrate an understanding of the methodology used by ACAS to issue TAs and RAs and the general criteria for the issuance of these advisories, including the following:

- (i) The minimum and maximum altitudes below/above which TAs will not be issued.

- (ii) When the vertical separation at CPA is projected to be less than the ACAS-desired separation, a corrective RA that requires a change to the existing vertical speed will be issued. This separation varies from 300 ft at low altitude to a maximum of 700 ft at high altitude.
 - (iii) When the vertical separation at CPA is projected to be just outside the ACAS-desired separation, a preventive RA that does not require a change to the existing vertical speed will be issued. This separation varies from 600 to 800 ft.
 - (iv) RA fixed range thresholds vary between 0.2 and 1.1 NM.
- (h) ACAS manoeuvre training
- (1) Demonstration of the flight crew member's ability to use ACAS displayed information to properly respond to TAs and RAs should be carried out in a full flight simulator equipped with an ACAS display and controls similar in appearance and operation to those in the aircraft. If a full flight simulator is utilised, crew resource management (CRM) should be practised during this training.
 - (2) Alternatively, the required demonstrations can be carried out by means of an interactive CBT with an ACAS display and controls similar in appearance and operation to those in the aircraft. This interactive CBT should depict scenarios in which real-time responses should be made. The flight crew member should be informed whether or not the responses made were correct. If the response was incorrect or inappropriate, the CBT should show what the correct response should be.
 - (3) The scenarios included in the manoeuvre training should include: corrective RAs; initial preventive RAs; maintain rate RAs; altitude crossing RAs; increase rate RAs; RA reversals; weakening RAs; and multi-aircraft encounters. The consequences of failure to respond correctly should be demonstrated by reference to actual incidents such as those publicised in EUROCONTROL ACAS II Bulletins (available on the EUROCONTROL website).
- (i) TA responses
 - Objective: to verify that the pilot properly interprets and responds to TAs.
 - Criteria: the pilot should demonstrate the following:
 - (A) Proper division of responsibilities between the pilot flying and the pilot monitoring. The pilot flying should fly the aircraft using any type-specific procedures and be prepared to respond to any RA that might follow. For aircraft without an RA pitch display, the pilot flying should consider the likely magnitude of an appropriate pitch change. The pilot monitoring should provide updates on the traffic location shown on the ACAS display, using this information to help visually acquire the intruder.
 - (B) Proper interpretation of the displayed information. Flight crew members should confirm that the aircraft they have visually acquired is that which has caused the TA to be issued. Use should be made of all information shown on the display, note being taken of the bearing and range of the intruder (amber circle), whether it is above or below (data tag), and its vertical speed direction (trend arrow).
 - (C) Other available information should be used to assist in visual acquisition, including ATC 'party-line' information, traffic flow in use, etc.
 - (D) Because of the limitations described, the pilot flying should not manoeuvre the aircraft based solely on the information shown on the ACAS display. No attempt should be made to adjust the current flight path in anticipation of what an RA would advise, except that if own aircraft is approaching its

cleared level at a high vertical rate with a TA present, vertical rate should be reduced to less than 1 500 ft/min.

- (E) When visual acquisition is attained, and as long as no RA is received, normal right of way rules should be used to maintain or attain safe separation. No unnecessary manoeuvres should be initiated. The limitations of making manoeuvres based solely on visual acquisition, especially at high altitude or at night, or without a definite horizon should be demonstrated as being understood.

(ii) RA responses

Objective: to verify that the pilot properly interprets and responds to RAs.

Criteria: the pilot should demonstrate the following:

- (A) Proper response to the RA, even if it is in conflict with an ATC instruction and even if the pilot believes that there is no threat present.
- (B) Proper task sharing between the pilot flying and the pilot monitoring. The pilot flying should respond to a corrective RA with appropriate control inputs. The pilot monitoring should monitor the response to the RA and should provide updates on the traffic location by checking the traffic display. Proper CRM should be used.
- (C) Proper interpretation of the displayed information. The pilot should recognise the intruder causing the RA to be issued (red square on display). The pilot should respond appropriately.
- (D) For corrective RAs, the response should be initiated in the proper direction within 5 seconds of the RA being displayed. The change in vertical speed should be accomplished with an acceleration of approximately $\frac{1}{4}$ g (gravitational acceleration of 9.81 m/sec²).
- (E) Recognition of the initially displayed RA being modified. Response to the modified RA should be properly accomplished, as follows:
 - (a) For increase rate RAs, the vertical speed change should be started within 2½ seconds of the RA being displayed. The change in vertical speed should be accomplished with an acceleration of approximately $\frac{1}{3}$ g.
 - (b) For RA reversals, the vertical speed reversal should be started within 2½ seconds of the RA being displayed. The change in vertical speed should be accomplished with an acceleration of approximately $\frac{1}{3}$ g.
 - (c) For RA weakenings, the vertical speed should be modified to initiate a return towards the original clearance.
 - (d) An acceleration of approximately $\frac{1}{4}$ g will be achieved if the change in pitch attitude corresponding to a change in vertical speed of 1 500 ft/min is accomplished in approximately 5 seconds, and of $\frac{1}{3}$ g if the change is accomplished in approximately 3 seconds. The change in pitch attitude required to establish a rate of climb or descent of 1 500 ft/min from level flight will be approximately 6° when the true airspeed (TAS) is 150 kt, 4° at 250 kt, and 2° at 500 kt. (These angles are derived from the formula: 1 000 divided by TAS.)
- (F) Recognition of altitude crossing encounters and the proper response to these RAs.

- (G) For preventive RAs, the vertical speed needle or pitch attitude indication should remain outside the red area on the RA display.
 - (H) For maintain rate RAs, the vertical speed should not be reduced. Pilots should recognise that a maintain rate RA may result in crossing through the intruder's altitude.
 - (I) When the RA weakens, or when the green 'fly to' indicator changes position, the pilot should initiate a return towards the original clearance, and when 'clear of conflict' is annunciated, the pilot should complete the return to the original clearance.
 - (J) The controller should be informed of the RA as soon as time and workload permit, using the standard phraseology.
 - (K) When possible, an ATC clearance should be complied with while responding to an RA. For example, if the aircraft can level at the assigned altitude while responding to RA (an 'adjust vertical speed' RA (version 7) or 'level off' (version 7.1), it should be done; the horizontal (turn) element of an ATC instruction should be followed.
 - (L) Knowledge of the ACAS multi-aircraft logic and its limitations, and that ACAS can optimise separations from two aircraft by climbing or descending towards one of them. For example, ACAS only considers intruders that it considers to be a threat when selecting an RA. As such, it is possible for ACAS to issue an RA against one intruder that results in a manoeuvre towards another intruder that is not classified as a threat. If the second intruder becomes a threat, the RA will be modified to provide separation from that intruder.
- (i) ACAS initial evaluation
- (1) The flight crew member's understanding of the academic training items should be assessed by means of a written test or interactive CBT that records correct and incorrect responses to phrased questions.
 - (2) The flight crew member's understanding of the manoeuvre training items should be assessed in a full flight simulator equipped with an ACAS display and controls similar in appearance and operation to those in the aircraft the flight crew member will fly, and the results assessed by a qualified instructor, inspector, or check airman. The range of scenarios should include: corrective RAs; initial preventive RAs; maintain rate RAs; altitude crossing RAs; increase rate RAs; RA reversals; weakening RAs; and multi-threat encounters. The scenarios should also include demonstrations of the consequences of not responding to RAs, slow or late responses, and manoeuvring opposite to the direction called for by the displayed RA.
 - (3) Alternatively, exposure to these scenarios can be conducted by means of an interactive CBT with an ACAS display and controls similar in appearance and operation to those in the aircraft the pilot will fly. This interactive CBT should depict scenarios in which real-time responses should be made and a record made of whether or not each response was correct.
- (j) ACAS recurrent training
- (1) ACAS recurrent training ensures that flight crew members maintain the appropriate ACAS knowledge and skills. ACAS recurrent training should be integrated into and/or conducted in conjunction with other established recurrent training programmes. An essential item of recurrent training is the discussion of any significant issues and operational concerns that have been identified by the operator. Recurrent training should also address changes

to ACAS logic, parameters or procedures and to any unique ACAS characteristics which flight crew members should be made aware of.

- (2) It is recommended that the operator's recurrent training programmes using full flight simulators include encounters with conflicting traffic when these simulators are equipped with ACAS. The full range of likely scenarios may be spread over a 2 year period. If a full flight simulator, as described above, is not available, use should be made of an interactive CBT that is capable of presenting scenarios to which pilot responses should be made in real-time.

SPO.OP.210 Approach and landing conditions — aeroplanes and helicopters

Before commencing an approach to land, the pilot-in-command shall be satisfied that, according to the information available, the weather at the aerodrome or the operating site and the condition of the runway or FATO intended to be used would not prevent a safe approach, landing or missed approach.

AMC1 SPO.OP.210 Approach and landing conditions — aeroplanes and helicopters**LANDING DISTANCE/FATO SUITABILITY**

The in-flight determination of the landing distance/FATO suitability should be based on the latest available meteorological report, or the locally observed conditions where appropriate.

SPO.OP.215 Commencement and continuation of approach — aeroplanes and helicopters

- (a) The pilot-in-command may commence an instrument approach regardless of the reported runway visual range/visibility (RVR/VIS).
- (b) If the reported RVR/VIS is less than the applicable minimum, the approach shall not be continued:
 - (1) below 1 000 ft above the aerodrome; or
 - (2) into the final approach segment in the case where the decision altitude/height (DA/H) or minimum descent altitude/height (MDA/H) is more than 1 000 ft above the aerodrome,
- (c) Where the RVR is not available, RVR values may be derived by converting the reported visibility.
- (d) If, after passing 1 000 ft above the aerodrome, the reported RVR/VIS falls below the applicable minimum, the approach may be continued to DA/H or MDA/H.
- (e) The approach may be continued below DA/H or MDA/H and the landing may be completed provided that the visual reference adequate for the type of approach operation and for the intended runway is established at the DA/H or MDA/H and is maintained.
- (f) The touchdown zone RVR shall always be controlling.

AMC1 SPO.OP.215 Commencement and continuation of approach — aeroplanes and helicopters

VISUAL REFERENCES FOR INSTRUMENT APPROACH OPERATIONS

- (a) NPA, APV and CAT I operations

At DH or MDH, at least one of the visual references specified below should be distinctly visible and identifiable to the pilot:

 - (1) elements of the approach lighting system;
 - (2) the threshold;
 - (3) the threshold markings;
 - (4) the threshold lights;
 - (5) the threshold identification lights;
 - (6) the visual glide slope indicator;
 - (7) the touchdown zone or touchdown zone markings;
 - (8) the touchdown zone lights;
 - (9) FATO/runway edge lights; or
 - (10) other visual references specified in the operations manual.
- (b) Lower than standard category I (LTS CAT I) operations

At DH, the visual references specified below should be distinctly visible and identifiable to the pilot:

 - (1) a segment of at least three consecutive lights, being the centreline of the approach lights, or touchdown zone lights, or runway centreline lights, or runway edge lights, or a combination of them; and
 - (2) this visual reference should include a lateral element of the ground pattern, such as an approach light crossbar or the landing threshold or a barrette of the touchdown zone light unless the operation is conducted utilising an approved HUDLS usable to at least 150 ft.

(c) CAT II or other-than standard category II (OTS CAT II) operations

At DH, the visual references specified below should be distinctly visible and identifiable to the pilot:

- (1) a segment of at least three consecutive lights, being the centreline of the approach lights, or touchdown zone lights, or runway centreline lights, or runway edge lights, or a combination of them; and
- (2) this visual reference should include a lateral element of the ground pattern, such as an approach light crossbar or the landing threshold or a barrette of the touchdown zone light unless the operation is conducted utilising an approved HUDLS to touchdown.

(d) CAT III operations

- (1) For CAT IIIA operations and for CAT IIIB operations conducted either with fail-passive flight control systems or with the use of an approved HUDLS: at DH, a segment of at least three consecutive lights, being the centreline of the approach lights, or touchdown zone lights, or runway centreline lights, or runway edge lights, or a combination of them is attained and can be maintained by the pilot.
- (2) For CAT IIIB operations conducted either with fail-operational flight control systems or with a fail-operational hybrid landing system using a DH: at DH, at least one centreline light is attained and can be maintained by the pilot.
- (3) For CAT IIIB operations with no DH there is no requirement for visual reference with the runway prior to touchdown.

(e) Approach operations utilising EVS — CAT I operations

- (1) At DH or MDH, the following visual references should be displayed and identifiable to the pilot on the EVS:
 - (i) elements of the approach light; or
 - (ii) the runway threshold, identified by at least one of the following:
 - (A) the beginning of the runway landing surface,
 - (B) the threshold lights, the threshold identification lights; or
 - (C) the touchdown zone, identified by at least one of the following: the runway touchdown zone landing surface, the touchdown zone lights, the touchdown zone markings or the runway lights.
- (2) At 100 ft above runway threshold elevation at least one of the visual references specified below should be distinctly visible and identifiable to the pilot without reliance on the EVS:
 - (i) the lights or markings of the threshold; or
 - (ii) the lights or markings of the touchdown zone.

(f) Approach operations utilising EVS – APV and NPA operations flown with the CDFA technique

- (1) At DH/MDH, visual references should be displayed and identifiable to the pilot on the EVS image as specified under (a).
- (2) At 200 ft above runway threshold elevation, at least one of the visual references specified under (a) should be distinctly visible and identifiable to the pilot without reliance on the EVS.

SPO.OP.225 Operational limitations — hot-air balloons

- (a) A hot-air balloon shall not land during night, except in emergency situations.
- (b) A hot-air balloon may take-off during night, provided sufficient fuel is carried for a landing during day.

GM1 SPO.OP.225 Operational limitations — hot-air balloons**AVOIDANCE OF NIGHT LANDING**

The intent of rule is to ensure that when the balloon takes off during night, sufficient fuel is on board for landing under VFR by day.

The risk of collision with overhead lines is considerable and cannot be overstated. The risk is considerably increased during night flights in conditions of failing light and visibility when there is increasing pressure to land. A number of incidents have occurred in the late evening in just such conditions, and may have been avoided had an earlier landing been planned. Night landings should therefore be avoided by taking appropriate measures, including a larger quantity of fuel and/or additional safety equipment.

SPO.OP.230 Standard operating procedures

- (a) Before commencing a specialised operation, the operator shall conduct a risk assessment, assessing the complexity of the activity to determine the hazards and associated risks inherent in the operation and establish mitigating measures.
- (b) Based on the risk assessment, the operator shall establish standard operating procedures (SOP) appropriate to the specialised activity and aircraft used taking account of the requirements of subpart E. The SOP shall be part of the operations manual or a separate document. SOP shall be regularly reviewed and updated, as appropriate.
- (c) The operator shall ensure that specialised operations are performed in accordance with SOP.

AMC1 SPO.OP.230 Standard operating procedures

DEVELOPMENT OF STANDARD OPERATING PROCEDURES

- (a) SOPs should be developed to a standard format in accordance with AMC2 SPO.OP.230 (SOP template) and taking into account the results of the risk assessment process.
- (b) SOPs should be based on a systematic risk assessment to ensure that the risks associated with the task are acceptable. The risk assessment should describe the activity in detail, identify the relevant hazards, analyse the causes and consequences of accidental events and establish methods to treat the associated risk.

AMC2 SPO.OP.230 Standard operating procedures

TEMPLATE

- (a) Nature and complexity of the activity:
 - (1) The nature of the activity and exposure. The nature of the flight and the risk exposure (e.g. low height) should be described.
 - (2) The complexity of the activity. Detail should be provided on how demanding the activity is with regard to the required piloting skills, the crew composition, the necessary level of experience, the ground support, safety and individual protective equipment that should be provided for persons involved.
 - (3) The operational environment and geographical area. The operational environment and geographical area over which the operation takes place should be described:
 - (i) congested hostile environment: aircraft performance standard, compliance with rules of the air, mitigation of third party risk;
 - (ii) mountain areas: altitude, performance, the use/non-use of oxygen with mitigating procedures;
 - (iii) sea areas: sea state and temperature, risk of ditching, availability of search and rescue, survivability, carriage of safety equipment;
 - (iv) desert areas: carriage of safety equipment, reporting procedures, search and rescue information; and
 - (v) other areas.
 - (4) The application of risk assessment and evaluation. The method of application of (a)(1) to (a)(3) to the particular operation so as to minimise risk should be described. The description should reference the risk assessment and the evaluation on which the procedure is based. The SOPs should:

- (i) contain elements relevant to the operational risk management performed during flight;
 - (ii) contain limitations, where required, such as weather, altitudes, speeds, power margins, masses, landing site size; and
 - (iii) list functions required to monitor the operation. Special monitoring requirements in addition to the normal functions should be described in the SOPs.
- (b) Aircraft and equipment:
- (1) The aircraft. The category of aircraft to be used for the activity should be indicated (e.g. helicopter/aeroplane, single/multi-engined, other-than complex motor-powered/complex motor-powered, classic tail rotor/Fenestron/no tail rotor (NOTAR) equipped). In particular, for helicopters, the necessary level of performance certification (Category A/B) should be specified.
 - (2) Equipment. All equipment required for the activity should be listed. This includes installed equipment certified in accordance with Part-21 as well as equipment approved in accordance with other officially recognised standards. A large number of activities require, in addition to the standard radio communication equipment, additional air-to-ground communication equipment. This should be listed and the operational procedure should be defined.
- (c) Crew members:
- (1) The crew composition, including the following, should be specified:
 - (i) minimum flight crew (according to the appropriate manual); and
 - (ii) additional flight crew.
 - (2) In addition, for flight crew members, the following should be specified:
 - (i) selection criteria (initial qualification, flight experience, experience of the activity);
 - (ii) initial training (volume and content of the training); and
 - (iii) recent experience requirement and/or recurrent training (volume and content of the training).

The criteria listed in (c)(2)(i) to (c)(2)(iii) should take into account the operational environment and the complexity of the activity and should be detailed in the training programmes.

- (d) Task specialists:
- (1) Whenever a task specialist is required, his/her function on board should be clearly defined. In addition, the following should be specified:
 - (i) selection criteria (initial background, experience of the activity);
 - (ii) initial training (volume and content of the training); and
 - (iii) recent experience requirement and/or recurrent training (volume and content of the training).

The criteria listed in (d)(1) should take into account the specialisation of the task specialist and should be detailed in the training programmes.

- (2) There is a large number of activities for which task specialists are required. This chapter should detail the following for such personnel:
 - (i) specialisation;
 - (ii) previous experience; and

(iii) training or briefing.

Briefing or specific training for task specialists referred to in (d)(2) should be detailed in the training programmes.

(e) Performance:

This chapter should detail the specific performance requirements to be applied, in order to ensure an adequate power margin.

(f) Normal procedures:

(1) Operating procedures. The operating procedures to be applied by the flight crew, including the coordination with task specialists.

(2) Ground procedures. The procedures to be applied by the task specialists should be described, e.g. loading/unloading, cargo hook operation.

(g) Emergency procedures:

(1) Operating procedures. The emergency procedures to be applied by the flight crew, the coordination with the task specialist and coordination between the flight crew and task specialists should be described.

(2) Ground procedures. The emergency procedures to be applied by the task specialists (e.g. in the case of a forced landing) should be specified.

(h) Ground equipment:

This chapter should detail the nature, number and location of ground equipment required for the activity, such as:

(1) refuelling facilities, dispenser and storage;

(2) firefighting equipment;

(3) size of the operating site (landing surface, loading/unloading area); and

(4) ground markings.

(i) Records:

It should be determined which records specific to the flight(s) are to be kept, such as task details, aircraft registration, pilot-in-command, flight times, weather and any remarks, including a record of occurrences affecting flight safety or the safety of persons or property on the ground.

GM1 SPO.OP.230 Standard operating procedures

TEMPLATE FORMS

Figure 1 — Development of a SOP based on a risk assessment

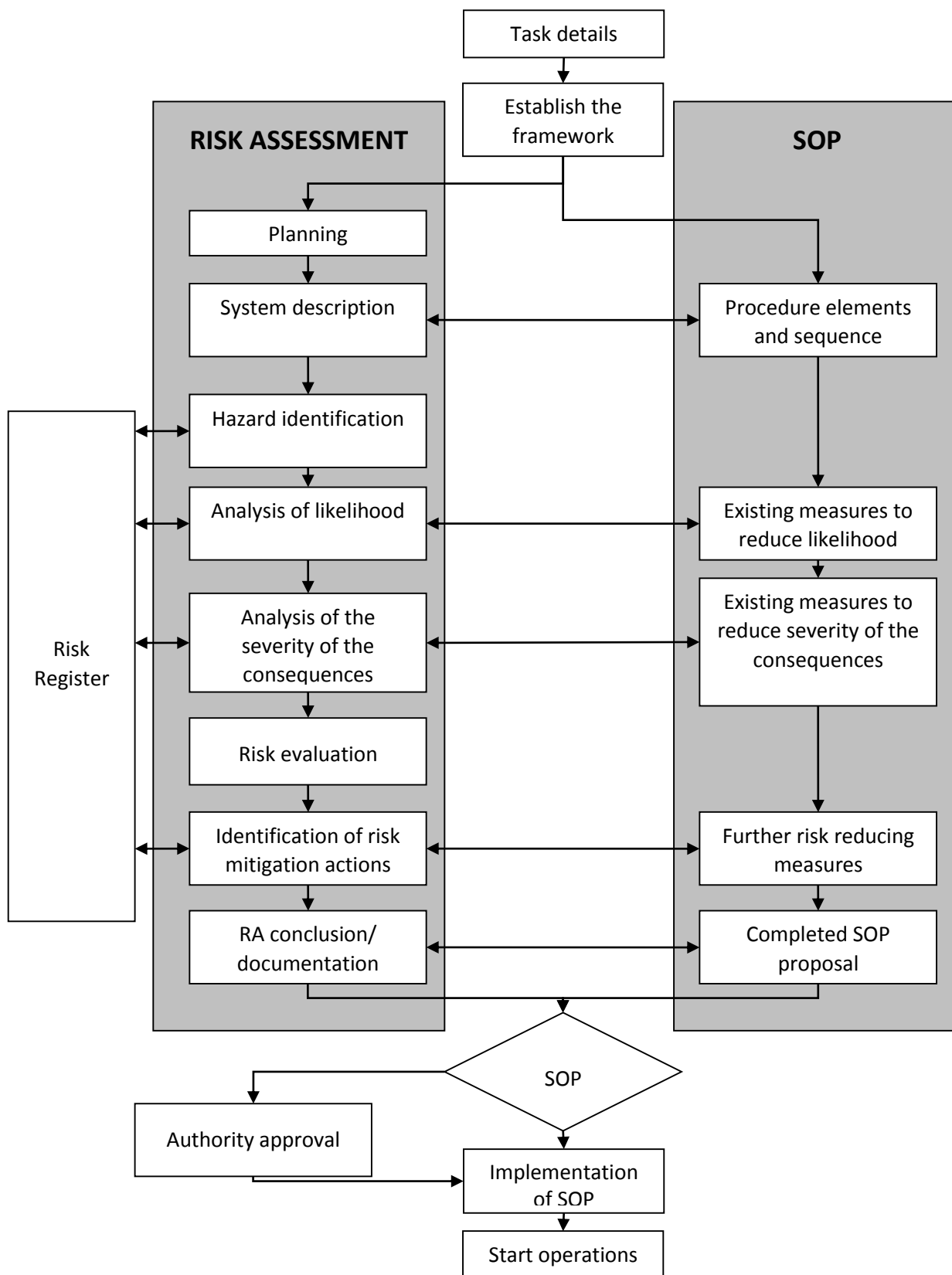

Template Form A — Risk assessment (RA)

Date: RA of Responsible:
Purpose:
Type of operation and brief description:
Participants, working group:
Preconditions, assumptions and simplifications:
Data used:
Description of the analysis method:
External context:
<ul style="list-style-type: none"> • Regulatory requirements • Approvals • Environmental conditions (visibility, wind, turbulence, contrast, light, elevation, etc. unless evident from the SOPs) • Stakeholders and their potential interest
Internal context:
<ul style="list-style-type: none"> • Type(s) of aircraft • Personnel and qualifications • Combination/similarity with other operations/SOPs • Other RA used/considered/plugged in
Existing barriers and emergency preparedness:
Monitoring and follow up:
Description of the risk:
Risk evaluation:
Conclusions:

Template Form B — Hazard identification (HI)

Date: HI of Responsible:

Phase of operation	Hazard ref	Hazard	Causes	Existing controls	Controls ref	Comments

Note:

Haz ref: A unique number for hazards, e.g. for use in a database

Controls ref: A unique number for the existing controls

Template Form C — Mitigating measures

Date: RA of Responsible:

Phase of operation	Haz ref	Consequence	Existing mitigation actions	Mitigation ref	L	S	Further mitigation required

Note:

Haz ref: A unique number for hazards, e.g. for use in a database

Mitigation ref: A unique number for the mitigation actions

L: Likelihood

S: Severity

Template register A — risk register

Ref	Operation/ Procedure	Ref	Hazard	Ref	Consequences	Mitigation actions	L	S	Monitoring

Note:

L: Likelihood

S: Severity

SUBPART C: AIRCRAFT PERFORMANCE AND OPERATING LIMITATIONS

SPO.POL.100 Operating limitations — all aircraft

- (a) During any phase of operation, the loading, the mass and, except for balloons, the centre of gravity (CG) position of the aircraft shall comply with any limitation specified in the appropriate manual.
- (b) Placards, listings, instrument markings, or combinations thereof, containing those operating limitations prescribed by the AFM for visual presentation, shall be displayed in the aircraft.

AMC1 SPO.POL.100 Operating Limitations — all aircraft

APPROPRIATE MANUAL

The appropriate manual containing operating limitations may be the AFM or an equivalent document, or the operations manual, if more restrictive.

SPO.POL.105 Mass and balance

- (a) The operator shall ensure that the mass and, except for balloons, the CG of the aircraft have been established by actual weighing prior to initial entry into service. The accumulated effects of modifications and repairs on the mass and balance shall be accounted for and properly documented. Such information shall be made available to the pilot-in-command. The aircraft shall be reweighed if the effect of modifications on the mass and balance is not accurately known.
- (b) The weighing shall be accomplished:
 - (1) for aeroplanes and helicopters, by the manufacturer of the aircraft or by an approved maintenance organisation; and
 - (2) for sailplanes and balloons, by the manufacturer of the aircraft or in accordance with Regulation (EC) No 2042/2003 as applicable.

GM1 SPO.POL.105 Mass and balance

GENERAL — OPERATIONS WITH OTHER-THAN COMPLEX MOTOR-POWERED AIRCRAFT

- (a) New aircraft that have been weighed at the factory may be placed into operation without reweighing if the mass records and, except for balloons, balance records have been adjusted for alterations or modifications to the aircraft. Aircraft transferred from one EU operator to another EU operator do not have to be weighed prior to use by the receiving operator unless the mass and balance cannot be accurately established by calculation.
- (b) For aircraft other than balloons, the mass and the centre of gravity (CG) position of an aircraft should be revised whenever the cumulative changes to the dry operating mass exceed $\pm 0.5\%$ of the maximum landing mass or for aeroplanes the cumulative change in CG position exceeds 0.5% of the mean aerodynamic chord. This may be done by weighing the aircraft or by calculation. If the AFM requires to record changes to mass and CG position below these thresholds, or to record changes in any case, and make them known to the pilot-in-command, mass and CG position should be revised accordingly and made known to the pilot-in-command
- (c) The initial empty mass for a balloon is the balloon empty mass determined by a weighing performed by the manufacturer of the balloon before the initial entry into service
- (d) The mass of a balloon should be revised whenever the cumulative changes to the balloon empty mass due to modifications or repairs exceed $\pm 10\%$ of the initial empty mass. This may be done by weighing the balloon or by calculation.

AMC1 SPO.POL.105(b) Mass and balance

WEIGHING OF AN AIRCRAFT — OPERATIONS WITH COMPLEX MOTOR POWERED AIRCRAFT

- (a) New aircraft that have been weighed at the factory may be placed into operation without reweighing if the mass and balance records have been adjusted for alterations or modifications to the aircraft. Aircraft transferred from one EU operator to another EU operator do not have to be weighed prior to use by the receiving operator unless the mass and balance cannot be accurately established by calculation.
- (b) The mass and centre of gravity (CG) position of an aircraft should be revised whenever the cumulative changes to the dry operating mass exceed $\pm 0.5\%$ of the maximum landing mass or for aeroplanes the cumulative change in CG position exceeds 0.5% of the mean aerodynamic chord. This should be done either by weighing the aircraft or by calculation.

- (c) When weighing an aircraft, normal precautions should be taken, which are consistent with good practices such as:
- (1) checking for completeness of the aircraft and equipment;
 - (2) determining that fluids are properly accounted for;
 - (3) ensuring that the aircraft is clean; and
 - (4) ensuring that weighing is accomplished in an enclosed building.
- (d) Any equipment used for weighing should be properly calibrated, zeroed and used in accordance with the manufacturer's instructions. Each scale should be calibrated either by the manufacturer, by a civil department of weights and measures or by an appropriately authorised organisation within 2 years or within a time period defined by the manufacturer of the weighing equipment, whichever is less. The equipment should enable the mass of the aircraft to be established accurately. One single accuracy criterion for weighing equipment cannot be given. However, the weighing accuracy is considered satisfactory if the accuracy criteria in Table 1 are met by the individual scales/cells of the weighing equipment used:

Table 1: Accuracy criteria for weighing equipment

For a scale/cell load	An accuracy of
below 2 000 kg	± 1 %
from 2 000 kg to 20 000 kg	± 20 kg
above 20 000 kg	± 0.1 %

CG LIMITS — OPERATIONAL CG ENVELOPE AND IN-FLIGHT CG

In the Certificate Limitations section of the AFM, forward and aft CG limits are specified. These limits ensure that the certification stability and control criteria are met throughout the whole flight and allow the proper trim setting for take-off. The operator should ensure that these limits are respected by:

- (a) defining and applying operational margins to the certified CG envelope in order to compensate for the following deviations and errors:
- (1) deviations of actual CG at empty or operating mass from published values due, for example, to weighing errors, unaccounted modifications and/or equipment variations.
 - (2) Deviations in fuel distribution in tanks from the applicable schedule.
 - (3) Deviations in the distribution of cargo in the various compartments as compared with the assumed load distribution as well as inaccuracies in the actual mass of cargo.
 - (5) Deviations of the actual CG of cargo load within individual cargo compartments or cabin sections from the normally assumed mid position.
 - (6) Deviations of the CG caused by gear and flap positions and by application of the prescribed fuel usage procedure, unless already covered by the certified limits.
 - (7) Deviations caused by in-flight movement of crew members and task specialist.
- (b) Defining and applying operational procedures in order to:
- (1) take into account any significant CG travel during flight caused by persons movement; and
 - (2) take into account any significant CG travel during flight caused by fuel consumption/transfer.

SPO.POL.110 Mass and balance system — commercial operations with aeroplanes and helicopters and non-commercial operations with complex motor-powered aircraft

- (a) The operator shall establish a mass and balance system for each flight or series of flights:
- (1) aircraft dry operating mass;
 - (2) mass of the traffic load;
 - (3) mass of the fuel load;
 - (4) aircraft load and load distribution;
 - (5) take-off mass, landing mass and zero fuel mass; and
 - (6) applicable aircraft CG positions.
- (b) The flight crew shall be provided with a means of replicating and verifying any mass and balance computation based on electronic calculations.
- (c) The operator shall establish procedures to enable the pilot-in-command to determine the mass of the fuel load by using the actual density or, if not known, the density calculated in accordance with a method specified in the operations manual.
- (d) The pilot-in-command shall ensure that the loading of:
- (1) the aircraft is performed under the supervision of qualified personnel; and
 - (2) traffic load is consistent with the data used for the calculation of the aircraft mass and balance.
- (e) The operator shall specify, in the operations manual, the principles and methods involved in the loading and in the mass and balance system that meet the requirements contained in (a) to (d). This system shall cover all types of intended operations.

AMC1 SPO.POL.110(a)(1) Mass and balance system — commercial operations with aeroplanes and helicopters and non-commercial operations with complex motor-powered aircraft

DRY OPERATING MASS

The dry operating mass should include:

- (a) crew and equipment, and
- (b) removable task specialist equipment, if applicable.

AMC1 SPO.POL.110(a)(2) Mass and balance system — commercial operations with aeroplanes and helicopters and non-commercial operations with complex motor-powered aircraft

SPECIAL STANDARD MASSES FOR TRAFFIC LOAD

The operator should use standard mass values for other load items. These standard masses should be calculated on the basis of a detailed evaluation of the mass of the items.

GM1 SPO.POL.110(a)(2) Mass and balance system — commercial operations with aeroplanes and helicopters and non-commercial operations with complex motor-powered aircraft

TRAFFIC LOAD

Traffic load includes task specialists.

AMC1 SPO.POL.110(a)(3) Mass and balance system — commercial operations with aeroplanes and helicopters and non-commercial operations with complex motor-powered aircraft**FUEL LOAD**

The mass of the fuel load should be determined by using its actual relative density or a standard relative density.

GM1 SPO.POL.110(a)(3) Mass and balance system — commercial operations with aeroplanes and helicopters and non-commercial operations with complex motor-powered aircraft**FUEL DENSITY**

- (a) If the actual fuel density is not known, the operator may use standard fuel density values for determining the mass of the fuel load. Such standard values should be based on current fuel density measurements for the airports or areas concerned.
- (b) Typical fuel density values are:
 - (1) Gasoline (piston engine fuel) – 0.71 ;
 - (2) JET A1 (Jet fuel JP 1) – 0.79 ;
 - (3) JET B (Jet fuel JP 4) – 0.76 ;
 - (4) Oil – 0.88.

AMC1 SPO.POL.110(a)(4) Mass and balance system — commercial operations with aeroplanes and helicopters and non-commercial operations with complex motor-powered aircraft**LOADING - STRUCTURAL LIMITS**

The loading should take into account additional structural limits such as the floor strength limitations, the maximum load per running metre, the maximum mass per cargo compartment, and/or the maximum seating limits as well as in-flight changes in loading.

GM1 SPO.POL.110(b) Mass and balance system — commercial operations with aeroplanes and helicopters and non-commercial operations with complex motor-powered aircraft**GENERAL**

The mass and balance computation may be available in flight planning documents or separate systems and may include standard load profiles.

SPO.POL.115 Mass and balance data and documentation — commercial operations with aeroplanes and helicopters and non-commercial operations with complex motor-powered aircraft

- (a) The operator shall establish mass and balance data and produce mass and balance documentation prior to each flight, or series of flights, specifying the load and its distribution in such a way that the mass and balance limits of the aircraft are not exceeded. The mass and balance documentation shall contain the following information:
- (1) aircraft registration and type;
 - (2) flight identification, number and date, as applicable;
 - (3) name of the pilot-in-command;
 - (4) name of the person who prepared the document;
 - (5) dry operating mass and the corresponding CG of the aircraft;
 - (6) mass of the fuel at take-off and the mass of trip fuel;
 - (7) mass of consumables other than fuel, if applicable;
 - (8) load components;
 - (9) take-off mass, landing mass and zero fuel mass;
 - (10) applicable aircraft CG positions; and
 - (11) the limiting mass and CG values.
- (b) Where mass and balance data and documentation is generated by a computerised mass and balance system, the operator shall verify the integrity of the output data.

AMC1 SPO.POL.115 Mass and balance data and documentation — commercial operations with aeroplanes and helicopters and non-commercial operations with complex motor-powered aircraft

GENERAL

- (a) The mass and balance documentation should:
- (1) enable the pilot-in-command to determine that the load and its distribution are within the mass and balance limits of the aircraft; and
 - (2) include advise to the pilot-in-command whenever a non-standard method has been used for determining the mass of the load.
- (b) The information above may be available in flight planning documents or mass and balance systems.
- (c) Any last minute change should be brought to the attention of the pilot-in-command and entered in the flight planning documents containing the mass and balance information and mass and balance systems.
- (d) Where mass and balance documentation is generated by a computerised mass and balance system, the operator should verify the integrity of the output data at intervals not exceeding six months.
- (e) A copy of the final mass and balance documentation may be sent to aircraft via data link or may be made available to the pilot-in-command by other means for its acceptance.
- (f) The person supervising the loading of the aircraft should confirm by hand signature or equivalent that the load and its distribution are in accordance with the mass and balance

documentation given to the pilot in command. The pilot-in-command should indicate his acceptance by hand signature or equivalent.

GM1 SPO.POL.115 Mass and balance data and documentation — commercial operations with aeroplanes and helicopters and non-commercial operations with complex motor-powered aircraft

SIGNATURE OR EQUIVALENT

Where a signature by hand is impracticable or it is desirable to arrange the equivalent verification by electronic means, as referred to in AMC1 SPO.POL.115 (f), the following conditions should be applied in order to make an electronic signature the equivalent of a conventional hand-written signature:

- (a) electronic 'signing' by entering a personal identification number (PIN) code with appropriate security, etc.;
- (b) entering the PIN code generates a print-out of the individual's name and professional capacity on the relevant document(s) in such a way that it is evident, to anyone having a need for that information, who has signed the document;
- (c) the computer system logs information to indicate when and where each PIN code has been entered;
- (d) the use of the PIN code is, from a legal and responsibility point of view, considered to be fully equivalent to signature by hand;
- (e) the requirements for record keeping remain unchanged; and
- (f) all personnel concerned are made aware of the conditions associated with electronic signature and this is documented.

AMC1 SPO.POL.115(b) Mass and balance data and documentation — commercial operations with aeroplanes and helicopters and non-commercial operations with complex motor-powered aircraft

INTEGRITY

The operator should verify the integrity of mass and balance data and documentation generated by a computerised mass and balance system, at intervals not exceeding six months. The operator should establish a system to check that amendments of its input data are incorporated properly in the system and that the system is operating correctly on a continuous basis.

AMC2 SPO.POL.115(b) Mass and balance data and documentation — commercial operations with aeroplanes and helicopters and non-commercial operations with complex motor-powered aircraft

MASS AND BALANCE DOCUMENTATION SENT VIA DATA LINK

Whenever the mass and balance documentation is sent to the aircraft via data link, a copy of the final mass and balance documentation as accepted by the pilot-in-command should be available on the ground.

GM1 SPO.POL.115(b) Mass and balance data and documentation — commercial operations with aeroplanes and helicopters and non-commercial operations with complex motor-powered aircraft

ON BOARD INTEGRATED MASS AND BALANCE COMPUTER SYSTEM

An on-board integrated mass and balance computer system may be an aircraft installed system capable of receiving input data either from other aircraft systems or from a mass and balance system on ground, in order to generate mass and balance data as an output.

GM2 SPO.POL.115(b) Mass and balance data and documentation — commercial operations with aeroplanes and helicopters and non-commercial operations with complex motor-powered aircraft

STAND-ALONE COMPUTERISED MASS AND BALANCE SYSTEM

A stand-alone computerised mass and balance system may be a computer, either as part of an electronic flight bag (EFB) system or solely dedicated to mass and balance purposes, requiring input from the user, in order to generate mass and balance data as an output.

SPO.POL.116 Mass and balance data and documentation — alleviations

Notwithstanding SPO.POL.115(a)(5), the CG position may not need not be on the mass and balance documentation, if the load distribution is in accordance with a pre-calculated balance table or if it can be shown that for the planned operations a correct balance can be ensured, whatever the real load is.

SPO.POL.120 Performance — general

The pilot-in-command shall only operate the aircraft if the performance is adequate to comply with the applicable rules of the air and any other restrictions applicable to the flight, the airspace or the aerodromes or operating sites used, taking into account the charting accuracy of any charts and maps used.

SPO.POL.125 Take-off mass limitations — complex motor-powered aeroplanes

The operator shall ensure that:

- (a) the mass of the aeroplane at the start of take-off shall not exceed the mass limitations:
 - (1) at take-off, as required in SPO.POL.130;
 - (2) en-route with one engine inoperative (OEI), as required in SPO.POL.135; and
 - (3) at landing, as required in SPO.POL.140,allowing for expected reductions in mass as the flight proceeds, and for fuel jettisoning;
- (b) the mass at the start of take-off shall never exceed the maximum take-off mass specified in the AFM for the pressure altitude appropriate to the elevation of the aerodrome or operating site, and if used as a parameter to determine the maximum take-off mass, any other local atmospheric condition; and
- (c) the estimated mass for the expected time of landing at the aerodrome or operating site of intended landing and at any destination alternate aerodrome shall never exceed the maximum landing mass specified in the AFM for the pressure altitude appropriate to the elevation of those aerodromes or operating sites and if used as a parameter to determine the maximum landing mass, any other local atmospheric condition.

SPO.POL.130 Take-off — complex motor-powered aeroplanes

- (a) When determining the maximum take-off mass, the pilot-in-command shall take the following into account:
 - (1) the calculated take-off distance shall not exceed the take-off distance available with a clearway distance not exceeding half of the take-off run available;
 - (2) the calculated take-off run shall not exceed the take-off run available;
 - (3) a single value of V1 shall be used for the rejected and continued take-off, where a V1 is specified in the AFM; and
 - (4) on a wet or contaminated runway, the take-off mass shall not exceed that permitted for a take-off on a dry runway under the same conditions.
- (b) Except for an aeroplane equipped with turboprop engines and a maximum take-off mass at or below 5 700 kg, in the event of an engine failure during take-off, the pilot-in-command shall ensure that the aeroplane is able:

- (1) to discontinue the take-off and stop within the accelerate-stop distance available or the runway available; or
- (2) to continue the take-off and clear all obstacles along the flight path by an adequate margin until the aeroplane is in a position to comply with SPO.POL.135.

AMC1 SPO.POL.130(a) Take-off — complex motor-powered aeroplanes

TAKE-OFF MASS

The following should be considered for determining the maximum take-off mass:

- (a) the pressure altitude at the aerodrome;
- (b) the ambient temperature at the aerodrome;
- (c) the runway surface condition and the type of runway surface;
- (d) the runway slope in the direction of take-off;
- (e) not more than 50 % of the reported head-wind component or not less than 150 % of the reported tailwind component; and
- (f) the loss, if any, of runway length due to alignment of the aeroplane prior to take-off.

AMC1 SPO.POL.130(a)(4) Take-off — complex motor-powered aeroplanes

CONTAMINATED RUNWAY PERFORMANCE DATA

Wet and contaminated runway performance data, if made available by the manufacturer, should be taken into account. If such data is not made available, the operator should account for wet and contaminated runway conditions by using the best information available.

GM1 SPO.POL.130(a)(4) Take-off — complex motor-powered aeroplanes

RUNWAY SURFACE CONDITION

Operation on runways contaminated with water, slush, snow or ice implies uncertainties with regard to runway friction and contaminant drag and therefore to the achievable performance and control of the aeroplane during take-off or landing, since the actual conditions may not completely match the assumptions on which the performance information is based. In the case of a contaminated runway, the first option for the pilot-in-command is to wait until the runway is cleared. If this is impracticable, he/she may consider a take-off or landing, provided that he/she has applied the applicable performance adjustments, and any further safety measures he/she considers justified under the prevailing conditions. The excess runway length available including the criticality of the overrun area should also be considered.

AMC1 SPO.POL.130(b)(2) Take-off — complex motor-powered aeroplanes

ADEQUATE MARGIN

The adequate margin should be defined in the operations manual.

GM1 SPO.POL.130(b)(2) Take-off — complex motor-powered aeroplanes

ADEQUATE MARGIN

`An adequate margin` is illustrated by the appropriate examples included in Attachment C to ICAO Annex 6, Part I.

SPO.POL.135 En-route — one engine inoperative — complex motor-powered aeroplanes

The pilot-in-command shall ensure that in the event of an engine becoming inoperative at any point along the route, a multi-engined aeroplane shall be able to continue the flight to an adequate aerodrome or operating site without flying below the minimum obstacle clearance altitude at any point.

SPO.POL.140 Landing — complex motor-powered aeroplanes

The pilot-in-command shall ensure that at any aerodrome or operating site, after clearing all obstacles in the approach path by a safe margin, the aeroplane shall be able to land and stop, or a seaplane to come to a satisfactory low speed, within the landing distance available. Allowance shall be made for expected variations in the approach and landing techniques, if such allowance has not been made in the scheduling of performance data.

AMC1 SPO.POL.140 Landing — complex motor-powered aeroplanes

GENERAL

The following should be considered to ensure that an aeroplane is able to land and stop, or a seaplane to come to a satisfactorily low speed, within the landing distance available:

- (a) the pressure altitude at the aerodrome;
- (b) the runway surface condition and the type of runway surface;
- (c) the runway slope in the direction of landing;
- (d) not more than 50 % of the reported head-wind component or not less than 150 % of the reported tailwind component;
- (e) use of the most favourable runway, in still air; and
- (f) use of the runway most likely to be assigned considering the probable wind speed and direction and the ground handling characteristics of the aeroplane, and considering other conditions such as landing aids and terrain.

AMC2 SPO.POL.140 Landing — complex motor-powered aeroplanes

ALLOWANCES

Allowances should be stated in the operations manual.

SPO.POL.145 Performance and operating criteria — aeroplanes

When operating an aeroplane at a height of less than 150 m (500 ft) above a non-congested area, for operations of aeroplanes that are not able to sustain level flight in the event of a critical engine failure, the operator shall:

- (a) establish operational procedures to minimise the consequences of an engine failure;
- (b) establish a training programme for crew members; and
- (c) ensure that all crew members and task specialists on board are briefed on the procedures to be carried out in the event of a forced landing.

**AMC1 SPO.POL.145(a) and (b) Performance and operating criteria — aeroplanes, and
AMC1 SPO.POL.146(b)(1) and (2) Performance and operating criteria — helicopters****OPERATIONAL PROCEDURES AND TRAINING PROGRAMME**

- (a) The operational procedures should be based on the manufacturer's recommended procedures where they exist.
- (b) The crew member training programme should include briefing, demonstration or practice, as appropriate, of the operational procedures necessary to minimise the consequences of an engine failure.

SPO.POL.146 Performance and operating criteria — helicopters

- (a) The pilot-in-command may operate an aircraft over congested areas provided that:
 - (1) the helicopter is certified in category A or B; and
 - (2) safety measures are established to prevent undue hazard to persons or property on the ground and the operation and its SOP is authorised.
- (b) The operator shall:
 - (1) establish operational procedures to minimise the consequences of an engine failure;
 - (2) establish a training programme for crew members; and
 - (3) ensure that all crew members and task specialists on board are briefed on the procedures to be carried out in the event of a forced landing.
- (c) The operator shall ensure that the mass at take-off, landing or hover shall not exceed the maximum mass specified for:
 - (1) a hover out of ground effect (HOGE) with all engines operating at the appropriate power rating; or
 - (2) if conditions prevail that a HOGE is not likely to be established, the helicopter mass shall not exceed the maximum mass specified for a hover in ground effect (HIGE) with all engines operating at the appropriate power rating, provided prevailing conditions allow a hover in ground effect at the maximum specified mass.

AMC1 SPO.POL.146(c) Performance and operating criteria — helicopters

MAXIMUM SPECIFIED MASSES

- (a) The operator should establish a procedure to determine maximum specified masses for HIGE and HOGE before each flight or series of flights.
- (b) This procedure should take into account ambient temperature at the aerodrome or operating site, pressure altitude and wind conditions data available.

GM1 SPO.POL.146(c) Performance and operating criteria — helicopters

GENERAL

- (a) Even when the surface allows a hover in ground effect (HIGE), the likelihood of, for example, dust or blowing snow may necessitate hover out of ground effect (HOGE) performance.
- (b) Wind conditions on some sites (particularly in mountainous areas and including downdraft) may require a reduction in the helicopter mass in order to ensure that an out of ground effect hover can be achieved at the operational site in the conditions prevailing.

SUBPART D: INSTRUMENTS, DATA AND EQUIPMENT

SECTION 1 Aeroplanes

SPO.IDE.A.100 Instruments and equipment — general

- (a) Instruments and equipment required by this Subpart shall be approved in accordance with the applicable airworthiness requirements if they are:
- (1) used by the flight crew to control the flight path;
 - (2) used to comply with SPO.IDE.A.215;
 - (3) used to comply with SPO.IDE.A.220; or
 - (4) installed in the aeroplane.
- (b) The following items, when required by this Subpart, do not need an equipment approval:
- (1) spare fuses,
 - (2) independent portable lights,
 - (3) an accurate time piece,
 - (4) chart holder,
 - (5) first-aid kits,
 - (6) survival and signalling equipment, and
 - (7) sea anchor and equipment for mooring.
- (c) Instruments and equipment not required by this Subpart as well as any other equipment that is not required by other applicable Annexes, but is carried on a flight, shall comply with the following:
- (1) the information provided by these instruments, equipment or accessories shall not be used by the flight crew to comply with Annex I to Regulation (EC) No 216/2008 or SPO.IDE.A.215 and SPO.IDE.A.220;
 - (2) the instruments and equipment shall not affect the airworthiness of the aeroplane, even in the case of failures or malfunction.
- (d) Instruments and equipment shall be readily operable or accessible from the station where the flight crew member that needs to use it is seated.
- (e) Those instruments that are used by a flight crew member shall be so arranged as to permit the flight crew member to see the indications readily from his/her station, with the minimum practicable deviation from the position and line of vision which he/she normally assumes when looking forward along the flight path.
- (f) All required emergency equipment shall be easily accessible for immediate use.

GM1 SPO.IDE.A.100(a) Instruments and equipment — general

APPLICABLE AIRWORTHINESS REQUIREMENTS

The applicable airworthiness requirements for approval of instruments and equipment required by this Part are the following:

- (a) Commission Regulation (EU) No 748/2012⁴ for aeroplanes registered in the EU; and
- (b) Airworthiness requirements of the State of registry for aeroplanes registered outside the EU.

GM1 SPO.IDE.A.100(b) Instruments and equipment — general

REQUIRED INSTRUMENTS AND EQUIPMENT THAT DO NOT NEED TO BE APPROVED IN ACCORDANCE WITH THE APPLICABLE AIRWORTHINESS REQUIREMENTS

The functionality of non-installed instruments and equipment required by this Subpart and that do not need an equipment approval, as listed in SPO.IDE.A.100(b), should be checked against recognised industry standards appropriate to the intended purpose. The operator is responsible for ensuring the maintenance of these instruments and equipment.

GM1 SPO.IDE.A.100(c) Instruments and equipment — general

NOT REQUIRED INSTRUMENTS AND EQUIPMENT THAT DO NOT NEED TO BE APPROVED IN ACCORDANCE WITH THE APPLICABLE AIRWORTHINESS REQUIREMENTS, BUT ARE CARRIED ON A FLIGHT

- (a) The provision of this paragraph does not exempt any installed instrument or item of equipment from complying with the applicable airworthiness requirements. In this case, the installation should be approved as required in the applicable airworthiness requirements and should comply with the applicable Certification Specifications.
- (b) The failure of additional non-installed instruments or equipment not required by this Part or by the applicable airworthiness requirements or any applicable airspace requirements should not adversely affect the airworthiness and/or the safe operation of the aeroplane. Examples may be the following:
 - (1) portable electronic flight bag (EFB);
 - (2) portable electronic devices carried by crew members or task specialists; and
 - (3) non-installed task specialist equipment.

GM1 SPO.IDE.A.100(d) Instruments and equipment — general

POSITIONING OF INSTRUMENTS

This requirement implies that whenever a single instrument is required in an aeroplane operated in a multi-crew environment, the instrument needs to be visible from each flight crew station.

⁴ Commission Regulation (EU) No 748/2012 of 3 August 2012 laying down implementing rules for the airworthiness and environmental certification of aircraft and related products, parts and appliances, as well as for the certification of design and production organisations, (OJ L 224, 21.8.2012, p. 1).

SPO.IDE.A.105 Minimum equipment for flight

A flight shall not be commenced when any of the aeroplane's instruments, items of equipment or functions required for the intended flight are inoperative or missing, unless:

- (a) the aeroplane is operated in accordance with the minimum equipment list (MEL), if established;
- (b) for complex-motor-powered aeroplanes and for any aeroplane used in commercial operations, the operator is approved by the competent authority to operate the aeroplane within the constraints of the master minimum equipment list (MMEL); or
- (c) the aeroplane is subject to a permit to fly issued in accordance with the applicable airworthiness requirements.

SPO.IDE.A.110 Spare electrical fuses

Aeroplanes shall be equipped with spare electrical fuses, of the ratings required for complete circuit protection, for replacement of those fuses that are allowed to be replaced in flight.

GM1 SPO.IDE.A.110 Spare electrical fuses**FUSES**

A spare electrical fuse means a replaceable fuse in the flight crew compartment, not an automatic circuit breaker or circuit breakers in the electric compartments.

SPO.IDE.A.115 Operating lights

Aeroplanes operated at night shall be equipped with:

- (a) an anti-collision light system;
- (b) navigation/position lights;
- (c) a landing light;
- (d) lighting supplied from the aeroplane's electrical system to provide adequate illumination for all instruments and equipment essential to the safe operation of the aeroplane;
- (e) lighting supplied from the aeroplane's electrical system to provide illumination in all cabin compartments;
- (f) an independent portable light for each crew member station; and
- (g) lights to conform with the International Regulations for Preventing Collisions at Sea if the aeroplane is operated as a seaplane.

SPO.IDE.A.120 Operations under VFR — flight and navigational instruments and associated equipment

- (a) Aeroplanes operated under VFR by day shall be equipped with a means of measuring and displaying the following:
 - (1) magnetic heading,
 - (2) time in hours, minutes and seconds,
 - (3) pressure altitude,
 - (4) indicated airspeed,
 - (5) Mach number whenever speed limitations are expressed in terms of Mach number, and
 - (6) slip for complex motor-powered aeroplanes.
- (b) Aeroplanes operating under VMC at night shall be, in addition to (a), equipped with:
 - (1) a means of measuring and displaying the following:
 - (i) turn and slip,
 - (ii) attitude,
 - (iii) vertical speed, and
 - (iv) stabilised heading;
 - (2) a means of indicating when the supply of power to the gyroscopic instruments is not adequate.
- (c) Complex motor-powered aeroplanes operating under VMC over water and out of sight of the land shall be, in addition to (a) and (b), equipped with a means of preventing malfunction of the airspeed indicating system due to condensation or icing.
- (d) Aeroplanes operated in conditions where they cannot be maintained in a desired flight path without reference to one or more additional instruments, shall be, in addition to (a) and (b), equipped with a means of preventing malfunction of the airspeed indicating system required in (a)(4) due to condensation or icing.

- (e) Whenever two pilots are required for the operation, aeroplanes shall be equipped with an additional separate means of displaying the following:
- (1) pressure altitude,
 - (2) indicated airspeed,
 - (3) slip, or turn and slip, as applicable,
 - (4) attitude, if applicable,
 - (5) vertical speed, if applicable
 - (6) stabilised heading, if applicable, and
 - (7) Mach number whenever speed limitations are expressed in terms of Mach number, if applicable.

AMC1 SPO.IDE.A.120 & SPO.IDE.A.125 Operations under VFR & operations under IFR — flight and navigational instruments and associated equipment

INTEGRATED INSTRUMENTS

- (a) Individual equipment requirements may be met by combinations of instruments, by integrated flight systems or by a combination of parameters on electronic displays. The information so available to each required pilot should not be less than that required in the applicable operational requirements, and the equivalent safety of the installation should be approved during type certification of the aeroplane for the intended type of operation.
- (b) The means of measuring and indicating turn and slip, aeroplane attitude and stabilised aeroplane heading may be met by combinations of instruments or by integrated flight director systems, provided that the safeguards against total failure, inherent in the three separate instruments, are retained.

AMC2 SPO.IDE.A.120 Operations under VFR — flight and navigational instruments and associated equipment

LOCAL FLIGHTS

For flights that do not exceed 60 minutes' duration, that take off and land at the same aerodrome, and that remain within 50 NM of that aerodrome, an equivalent means of complying with SPO.IDE.A.120 (b)(1)(i), (b)(1)(ii) may be:

- (a) a turn and slip indicator;
- (b) a turn co-ordinator; or
- (c) both an attitude indicator and a slip indicator.

GM1 SPO.IDE.A.120 Operations under VFR — flight and navigational instruments and associated equipment

SLIP INDICATION

Non-complex motor-powered aeroplanes should be equipped with a means of measuring and displaying slip.

AMC1 SPO.IDE.A.120(a)(1) & SPO.IDE.A.125(a)(1) Operations under VFR & operations under IFR — flight and navigational instruments and associated equipment

MEANS OF MEASURING AND DISPLAYING MAGNETIC HEADING

The means of measuring and displaying magnetic direction should be a magnetic compass or equivalent.

AMC1 SPO.IDE.A.120(a)(2) & SPO.IDE.A.125(a)(2) Operations under VFR & operations under IFR — flight and navigational instruments and associated equipment

MEANS OF MEASURING AND DISPLAYING THE TIME — COMPLEX MOTOR-POWERED AIRCRAFT

An acceptable means of compliance is a clock displaying hours, minutes and seconds, with a sweep-second pointer or digital presentation.

MEANS OF MEASURING AND DISPLAYING THE TIME — OTHER-THAN COMPLEX MOTOR-POWERED AIRCRAFT

An acceptable means of measuring and displaying the time in hours, minutes and seconds may be a wrist watch capable of the same functions.

AMC1 SPO.IDE.A.120(a)(3) & SPO.IDE.A.125(a)(3) Operations under VFR operations & operations under IFR — flight and navigational instruments and associated equipment

CALIBRATION OF THE MEANS OF MEASURING AND DISPLAYING PRESSURE ALTITUDE

The instrument measuring and displaying pressure altitude should be of a sensitive type calibrated in feet (ft), with a sub-scale setting, calibrated in hectopascals/millibars, adjustable for any barometric pressure likely to be set during flight.

AMC1 SPO.IDE.A.120(a)(4) & SPO.IDE.A.125(a)(4) Operations under VFR & operations under IFR — flight and navigational instruments and associated equipment

CALIBRATION OF THE INSTRUMENT INDICATING AIRSPEED

- (a) The instrument indicating airspeed should be calibrated in knots (kt).
- (b) In the case of aeroplanes with a maximum certified take-off mass (MCTOM) below 2 000 kg, calibration in kilometres per hour (kph) or in miles per hour (mph) is acceptable when such units are used in the AFM.

AMC1 SPO.IDE.A.120(c) & SPO.IDE.A.125(d) Operations under VFR & operations under IFR — flight and navigational instruments and associated equipment

MEANS OF PREVENTING MALFUNCTION DUE TO CONDENSATION OR ICING

The means of preventing malfunction due to either condensation or icing of the airspeed indicating system should be a heated pitot tube or equivalent.

AMC1 SPO.IDE.A.120(e) & SPO.IDE.A.125(c) Operations under VFR & operations under IFR — flight and navigational instruments and associated equipment**MULTI-PILOT OPERATIONS — DUPLICATE INSTRUMENTS**

Duplicate instruments include separate displays for each pilot and separate selectors or other associated equipment where appropriate.

SPO.IDE.A.125 Operations under IFR — flight and navigational instruments and associated equipment

Aeroplanes operated under IFR shall be equipped with:

- (a) a means of measuring and displaying the following:
 - (1) magnetic heading,
 - (2) time in hours, minutes and seconds,
 - (3) pressure altitude,
 - (4) indicated airspeed,
 - (5) vertical speed,
 - (6) turn and slip,
 - (7) attitude,
 - (8) stabilised heading,
 - (9) outside air temperature, and
 - (10) Mach number, whenever speed limitations are expressed in terms of Mach number;
- (b) a means of indicating when the supply of power to the gyroscopic instruments is not adequate.
- (c) whenever two pilots are required for the operation, an additional separate means of displaying for the second pilot:
 - (1) pressure altitude,
 - (2) indicated airspeed,
 - (3) vertical speed,
 - (4) turn and slip,
 - (5) attitude,
 - (6) stabilised heading, and
 - (7) Mach number whenever speed limitations are expressed in terms of Mach number, if applicable;
- (d) a means of preventing malfunction of the airspeed indicating system required in (a)(4) and (c)(2) due to condensation or icing; and
- (e) complex motor-powered aeroplanes when operated under IFR shall, in addition to (a), (b), (c) and (d), be equipped with:
 - (1) an alternate source of static pressure;
 - (2) a chart holder in an easily readable position that can be illuminated for night operations;
 - (3) a second independent means of measuring and displaying altitude unless already installed to comply with (e)(1); and
 - (4) an emergency power supply, independent of the main electrical generating system, for the purpose of operating and illuminating an attitude indicating system for a minimum period of 30 minutes. The emergency power supply shall be automatically operative after the total failure of the main electrical generating system and clear indication shall be given on the instrument that the attitude indicator is being operated by emergency power.

GM1 SPO.IDE.A.125 Operations under IFR — flight and navigational instruments and associated equipment

ALTERNATE SOURCE OF STATIC PRESSURE

Aeroplanes should be equipped with an alternate source of static pressure.

GM1 SPO.IDE.A.125(a)(3) Operations under IFR — flight and navigational instruments and associated equipment

ALTIMETERS

Altimeters with counter drum-pointer or equivalent presentation are considered to be less susceptible to misinterpretation for aeroplanes operating above 10 000 ft.

AMC1 SPO.IDE.A.125(a)(9) Operations under IFR — flight and navigational instruments and associated equipment

MEANS OF DISPLAYING OUTSIDE AIR TEMPERATURE

- (a) The means of displaying outside air temperature should be calibrated in degrees Celsius.
- (b) In the case of aeroplanes with a maximum certified take-off mass (MCTOM) below 2 000 kg, calibration in degrees Fahrenheit is acceptable, when such unit is used in the AFM.
- (c) The means of displaying outside air temperature may be an air temperature indicator that provides indications that are convertible to outside air temperature.

AMC1 SPO.IDE.A.125(e)(2) Operations under IFR — flight and navigational instruments and associated equipment

CHART HOLDER

An acceptable means of compliance with the chart holder requirement for complex motor-powered aeroplanes is to display a pre-composed chart on an electronic flight bag (EFB).

SPO.IDE.A.126 Additional equipment for single-pilot operation under IFR

Complex motor-powered aeroplanes operated under IFR with a single pilot shall be equipped with an autopilot with at least altitude hold and heading mode.

SPO.IDE.A.130 Terrain awareness warning system (TAWS)

Turbine-powered aeroplanes with a maximum certified take-off mass (MCTOM) of more than 5 700 kg or an MOPSC of more than nine shall be equipped with a TAWS that meets the requirements for:

- (a) class A equipment, as specified in an acceptable standard, in the case of aeroplanes for which the individual certificate of airworthiness (CofA) was first issued after 1 January 2011; or
- (b) class B equipment, as specified in an acceptable standard, in the case of aeroplanes for which the individual CofA was first issued on or before 1 January 2011.

AMC1 SPO.IDE.A.130 Terrain awareness warning system (TAWS)**EXCESSIVE DOWNWARDS GLIDESLOPE DEVIATION WARNING FOR CLASS A TAWS**

The requirement for a Class A TAWS to provide a warning to the flight crew for excessive downwards glideslope deviation should apply to all final approach glideslopes with angular vertical navigation (VNAV) guidance, whether provided by the instrument landing system (ILS), microwave landing system (MLS), satellite-based augmentation system approach procedure with vertical guidance (SBAS APV (localiser performance with vertical guidance approach LPV)), ground-based augmentation system (GBAS (GPS landing system, GLS)) or any other systems providing similar guidance. The same requirement should not apply to systems providing vertical guidance based on barometric VNAV.

GM1 SPO.IDE.A.130 Terrain awareness warning system (TAWS)**ACCEPTABLE STANDARD FOR TAWS**

An acceptable standard for Class A and Class B TAWS may be the applicable European Technical Standards Order (ETSO) issued by the Agency or equivalent.

SPO.IDE.A.131 Airborne collision avoidance system (ACAS II)

Unless otherwise provided for by Regulation (EU) No 1332/2011, turbine-powered aeroplanes with an MCTOM of more than 5700 kg shall be equipped with ACAS II.

SPO.IDE.A.132 Airborne weather detecting equipment — complex motor-powered aeroplanes

The following aeroplanes shall be equipped with airborne weather detecting equipment when operated at night or in IMC in areas where thunderstorms or other potentially hazardous weather conditions, regarded as detectable with airborne weather detecting equipment, may be expected to exist along the route:

- (a) pressurised aeroplanes;
- (b) non-pressurised aeroplanes with an MCTOM of more than 5 700 kg.

AMC1 SPO.IDE.A.132 Airborne weather detecting equipment — complex motor-powered aeroplanes**GENERAL**

The airborne weather detecting equipment should be an airborne weather radar. However, for propeller-driven pressurised aeroplanes with an MCTOM not more than 5 700 kg and an maximum certified seating configuration of not more than nine, other equipment capable of detecting thunderstorms and other potentially hazardous weather conditions, regarded as detectable with airborne weather radar equipment, are also acceptable.

SPO.IDE.A.133 Additional equipment for operations in icing conditions at night — complex motor-powered aeroplanes

- (a) Aeroplanes operated in expected or actual icing conditions at night shall be equipped with a means to illuminate or detect the formation of ice.
- (b) The means to illuminate the formation of ice shall not cause glare or reflection that would handicap flight crew members in the performance of their duties.

SPO.IDE.A.135 Flight crew interphone system

Aeroplanes operated by more than one flight crew member shall be equipped with a flight crew interphone system, including headsets and microphones for use by all flight crew members.

AMC1 SPO.IDE.A.135 Flight crew interphone system

TYPE OF FLIGHT CREW INTERPHONE

The flight crew interphone system should not be of a handheld type.

SPO.IDE.A.140 Cockpit voice recorder

- (a) The following aeroplanes shall be equipped with a CVR:
- (1) aeroplanes with an MCTOM of more than 27 000 kg and first issued with an individual CofA on or after 1 January 2016; and
 - (2) aeroplanes with an MCTOM of more than 2 250 kg:
 - (i) certified for operation with a minimum crew of at least two pilots;
 - (ii) equipped with turbojet engine(s) or more than one turboprop engine; and
 - (iii) for which a type certificate is first issued on or after 1 January 2016.
- (b) The CVR shall be capable of retaining data recorded during at least:
- (1) the preceding 25 hours for aeroplanes with an MCTOM of more than 27 000 kg and first issued with an individual CofA on or after 1 January 2021; or
 - (2) the preceding 2 hours in all other cases.
- (c) The CVR shall record with reference to a timescale:
- (1) voice communications transmitted from or received in the flight crew compartment by radio;
 - (2) flight crew members' voice communications using the interphone system and the public address system, if installed;
 - (3) the aural environment of the flight crew compartment, including, without interruption, the audio signals received from each boom and mask microphone in use; and
 - (4) voice or audio signals identifying navigation or approach aids introduced into a headset or speaker.
- (d) The CVR shall start automatically to record prior to the aeroplane moving under its own power and shall continue to record until the termination of the flight when the aeroplane is no longer capable of moving under its own power.
- (e) In addition to (d), depending on the availability of electrical power, the CVR shall start to record as early as possible during the cockpit checks prior to engine start at the beginning of the flight until the cockpit checks immediately following engine shutdown at the end of the flight.
- (f) If the CVR is not deployable, it shall have a device to assist in locating it under water. By 1 January 2020 at the latest, this device shall have a minimum underwater transmission time of 90 days. If the CVR is deployable, it shall have an automatic emergency locator transmitter.

AMC1 SPO.IDE.A.140 Cockpit voice recorder

GENERAL

- (a) The operational performance requirements for cockpit voice recorders (CVRs) should be those laid down in the European Organisation for Civil Aviation Equipment (EUROCAE) Document ED-112 (Minimum Operational Performance Specification for Crash Protected Airborne Recorder Systems), dated March 2003, including Amendments n°1 and n°2, or any later equivalent standard produced by EUROCAE.
- (b) The operational performance requirements for equipment dedicated to the CVR should be those laid down in the European Organisation for Civil Aviation Equipment (EUROCAE) Document ED-56A (Minimum Operational Performance Requirements For Cockpit Voice Recorder Systems)

dated December 1993, or EUROCAE Document ED-112 (Minimum Operational Performance Specification for Crash Protected Airborne Recorder Systems) dated March 2003, including Amendments n°1 and n°2, or any later equivalent standard produced by EUROCAE.

SPO.IDE.A.145 Flight data recorder

- (a) Aeroplanes with an MCTOM of more than 5 700 kg and first issued with an individual CofA on or after 1 January 2016 shall be equipped with an FDR that uses a digital method of recording and storing data and for which a method of readily retrieving that data from the storage medium is available.
- (b) The FDR shall record the parameters required to determine accurately the aeroplane flight path, speed, attitude, engine power, configuration and operation and be capable of retaining data recorded during at least the preceding 25 hours.
- (c) Data shall be obtained from aeroplane sources that enable accurate correlation with information displayed to the flight crew.
- (d) The FDR shall start automatically to record the data prior to the aeroplane being capable of moving under its own power and shall stop automatically after the aeroplane is incapable of moving under its own power.
- (e) If the FDR is not deployable, it shall have a device to assist in locating it under water. By 1 January 2020 at the latest, this device shall have a minimum underwater transmission time of 90 days. If the FDR is deployable, it shall have an automatic emergency locator transmitter.

AMC1 SPO.IDE.A.145 Flight data recorder

OPERATIONAL PERFORMANCE REQUIREMENTS FOR AEROPLANES FIRST ISSUED WITH AN INDIVIDUAL CofA ON OR AFTER 1 JANUARY 2016 AND BEFORE 1 JANUARY 2023

- (a) The operational performance requirements for flight data recorders (FDRs) should be those laid down in EUROCAE Document ED-112 (Minimum Operational Performance Specification for Crash Protected Airborne Recorder Systems) dated March 2003, including Amendments No 1 and No 2, or any later equivalent standard produced by EUROCAE.
- (b) The flight data recorder should record, with reference to a timescale, the list of parameters in Table 1 and Table 2, as applicable.
- (c) The parameters to be recorded should meet the performance specifications (designated ranges, sampling intervals, accuracy limits and minimum resolution in read-out) as defined in the relevant tables of EUROCAE Document ED-112 (Minimum Operational Performance Specification for Crash Protected Airborne Recorder Systems), dated March 2003, including Amendments No 1 and No 2, or any later equivalent standard produced by EUROCAE.

Table 1: All Aeroplanes

No*	Parameter
1a	Time; or
1b	Relative time count
1c	Global navigation satellite system (GNSS) time synchronisation
2	Pressure altitude
3	Indicated airspeed; or calibrated airspeed

4	Heading (primary flight crew reference) — when true or magnetic heading can be selected, the primary heading reference, a discrete indicating selection, should be recorded
5	Normal acceleration
6	Pitch attitude
7	Roll attitude
8	Manual radio transmission keying and CVR/FDR synchronisation reference.
9	Engine thrust/power
9a	Parameters required to determine propulsive thrust/power on each engine
9b	Flight crew compartment thrust/power lever position for aeroplanes with no mechanical link between engine and flight crew compartment))
14	Total or outside air temperature
16	Longitudinal acceleration (body axis)
17	Lateral acceleration
18	Primary flight control surface and/or primary flight control pilot input (for aeroplanes with control systems in which movement of a control surface will back drive the pilot's control, 'or' applies. For aeroplanes with control systems in which movement of a control surface will not back drive the pilot's control, 'and' applies. For multiple or split surfaces, a suitable combination of inputs is acceptable instead of recording each surface separately. For aeroplanes that have a flight control break-away capability that allows either pilot to operate the controls independently, record both inputs):
18a	Pitch axis
18b	Roll axis
18c	Yaw axis
19	Pitch trim surface position
23	Marker beacon passage
24	Warnings - in addition to the master warning each 'red' warning (including smoke warnings from other compartments) should be recorded when the warning condition cannot be determined from other parameters or from the CVR
25	Each navigation receiver frequency selection
27	Air-ground status. Air-ground status and a sensor of each landing gear if installed

* The number in the left hand column reflects the serial number depicted in EUROCAE ED-112.

Table 2: Aeroplanes for which the data source for the parameter is either used by aeroplane systems or is available on the instrument panel for use by the flight crew to operate the aeroplane

No*	Parameter
10	Flaps
10a	Trailing edge flap position
10b	Flight crew compartment control selection
11	Slats
11a	Leading edge flap (slat) position
11b	Flight crew compartment control selection
12	Thrust reverse status
13	Ground spoiler and speed brake:
13a	Ground spoiler position
13b	Ground spoiler selection
13c	Speed brake position
13d	Speed brake selection
15	Autopilot, autothrottle, automatic flight control system (AFCS) mode and engagement status
20	Radio altitude. For autoland/Category III operations, each radio altimeter should be recorded.
21	Vertical deviation – the approach aid in use should be recorded. For autoland/Category III operations, each system should be recorded.
21a	ILS/GPS/GLS glide path
21b	MLS elevation
21c	Integrated approach navigation (IAN)/integrated area navigation (IRNAV), vertical deviation
22	Horizontal deviation — the approach aid in use should be recorded. For autoland/CAT III operations, each system should be recorded. It is acceptable to arrange them so that at least one is recorded every second).
22a	ILS/GPS/GLS localiser
22b	MLS azimuth
22c	GNSS approach path/IRNAV lateral deviation
26	Distance measuring equipment (DME) 1 and 2 distances
26a	Distance to runway threshold(GLS)

No*	Parameter
26b	Distance to missed approach point (IRNAV/IAN)
28	Ground proximity warning system (GPWS)/TAWS/ground collision avoidance system (GCAS) status:
28a	Selection of terrain display mode, including pop-up display status
28b	Terrain alerts, including cautions and warnings and advisories
28c	On/off switch position
29	Angle of attack
30	Low pressure warning (each system):
30a	Hydraulic pressure
30b	Pneumatic pressure
31	Ground speed
32	Landing gear:
32a	Landing gear position
32b	Gear selector position
33	Navigation data:
33a	Drift angle
33b	Wind speed
33c	Wind direction
33d	Latitude
33e	Longitude
33f	GNSS augmentation in use
34	Brakes:
34a	Left and right brake pressure
34b	Left and right brake pedal position
35	Additional engine parameters (if not already recorded in parameter 9 of Table 1 of AMC1 SPO.IDE.A.145 and if the aeroplane is equipped with a suitable data source):
35a	Engine pressure ratio (EPR)
35b	N ₁
35c	Indicated vibration level
35d	N ₂
35e	Exhaust gas temperature (EGT)
35f	Fuel flow

No*	Parameter
35g	Fuel cut-off lever position
35h	N ₃
36	Traffic alert and collision avoidance system (TCAS)/ACAS - a suitable combination of discretés should be recorded to determine the status of the system:
36a	Combined control
36b	Vertical control
36c	Up advisory
36d	Down advisory
36e	Sensitivity level
37	Wind shear warning
38	Selected barometric setting
38a	Pilot
38b	Co-pilot
39	Selected altitude (all pilot selectable modes of operation) — to be recorded for the aeroplane where the parameter is displayed electronically
40	Selected speed (all pilot selectable modes of operation) — to be recorded for the aeroplane where the parameter is displayed electronically
41	Selected Mach (all pilot selectable modes of operation) — to be recorded for the aeroplane where the parameter is displayed electronically
42	Selected vertical speed (all pilot selectable modes of operation) — to be recorded for the aeroplane where the parameter is displayed electronically
43	Selected heading (all pilot selectable modes of operation) — to be recorded for the aeroplane where the parameter is displayed electronically
44	Selected flight path (All pilot selectable modes of operation) — to be recorded for the aeroplane where the parameter is displayed electronically:
44a	Course/desired track (DSTRK)
44b	Path angle
44c	Coordinates of final approach path (IRNAV/IAN)
45	Selected decision height — to be recorded for the aeroplane where the parameter is displayed electronically
46	Electronic flight instrument system (EFIS) display format:
46a	Pilot
46b	Co-pilot

No*	Parameter
47	Multi-function/engine/alerts display format
48	AC electrical bus status — each bus
49	DC electrical bus status — each bus
50	Engine bleed valve position
51	Auxiliary power unit (APU) bleed valve position
52	Computer failure — (all critical flight and engine control systems)
53	Engine thrust command
54	Engine thrust target
55	Computed centre of gravity (CG)
56	Fuel quantity in CG trim tank
57	Head-up display in use
58	Para visual display on
59	Operational stall protection, stick shaker and pusher activation
60	Primary navigation system reference:
60a	GNSS
60b	Inertial navigational system (INS)
60c	VHF omnidirectional radio range (VOR)/DME
60d	MLS
60e	Loran C
60f	ILS
61	Ice detection
62	Engine warning — each engine vibration
63	Engine warning — each engine over temperature
64	Engine warning — each engine oil pressure low
65	Engine warning — each engine over speed
66	Yaw trim surface position
67	Roll trim surface position

No*	Parameter
68	Yaw or sideslip angle
69	De-icing and/or anti-icing systems selection
70	Hydraulic pressure — each system
71	Loss of cabin pressure
72	Trim control input position in the flight crew compartment, pitch — when mechanical means for control inputs are not available, displayed trim position or trim command should be recorded
73	Trim control input position in the flight crew compartment, roll — when mechanical means for control inputs are not available, displayed trim position or trim command should be recorded
74	Trim control input position in the flight crew compartment, yaw — when mechanical means for control inputs are not available, displayed trim position or trim command should be recorded
75	All flight control input forces (for fly-by-wire flight control systems, where control surface position is a function of the displacement of the control input device only, it is not necessary to record this parameter):
75a	Control wheel
75b	Control column
75c	Rudder pedal
76	Event marker
77	Date
78	Actual navigation performance (ANP) or estimate of position error (EPE) or estimate of position uncertainty (EPU)

* The number in the left hand column reflects the serial number depicted in EUROCAE ED-112.

AMC2 SPO.IDE.A.145 Flight data recorder

OPERATIONAL PERFORMANCE REQUIREMENTS FOR AEROPLANES FIRST ISSUED WITH AN INDIVIDUAL CofA ON OR AFTER 1 JANUARY 2023

- (a) The operational performance requirements for flight data recorders (FDRs) should be those laid down in EUROCAE Document 112A (Minimum Operational Performance Specification for Crash Protected Airborne Recorder Systems) dated September 2013, or any later equivalent standard produced by EUROCAE.
- (b) The FDR should, with reference to a timescale, record:
- (1) the list of parameters in Table 1 below;

- (2) the additional parameters listed in Table 2 below, when the information data source for the parameter is used by aeroplane systems or is available on the instrument panel for use by the flight crew to operate the aeroplane; and
- (3) any dedicated parameters related to novel or unique design or operational characteristics of the aeroplane as determined by the Agency.
- (c) The parameters to be recorded should meet the performance specifications (range, sampling intervals, accuracy limits and resolution in read-out) as defined in the relevant tables of EUROCAE Document 112A, or any later equivalent standard produced by EUROCAE.

Table 1: FDR — all aeroplanes

No*	Parameter
1a	Time; or
1b	Relative time count
1c	Global navigation satellite system (GNSS) time synchronisation
2	Pressure altitude (including altitude values displayed on each flight crew member's primary flight display)
3	Indicated airspeed or calibrated airspeed (including values of indicated airspeed or calibrated airspeed displayed on each flight crew member's primary flight display)
4	Heading (primary flight crew reference) — when true or magnetic heading can be selected, the primary heading reference, a discrete indicating selection should be recorded
5	Normal acceleration
6	Pitch attitude — pitch attitude values displayed on each flight crew member's primary flight display should be recorded, unless the aeroplane is type certified before 1 January 2023 and recording the values displayed at the captain position or the first officer position would require extensive modification.
7	Roll attitude — roll attitude values displayed on each flight crew member's primary flight display should be recorded, unless the aeroplane is type certified before 1 January 2023 and recording the values displayed at the captain position or the first officer position would require extensive modification.
8	Manual radio transmission keying and CVR/FDR synchronisation reference
9	Engine thrust/power:
9a	Parameters required to determine propulsive thrust/power on each engine, in both normal and reverse thrust
9b	Flight crew compartment thrust/power lever position (for aeroplanes with non-mechanically linked engine controls in the flight crew compartment)
14	Total or outside air temperature
16	Longitudinal acceleration (body axis)

No*	Parameter
17	Lateral acceleration
18	Primary flight control surface and/or primary flight control pilot input (For aeroplanes with control systems in which the movement of a control surface will back drive the pilot's control, 'or' applies. For aeroplanes with control systems in which the movement of a control surface will not back drive the pilot's control, 'and' applies. For multiple or split surfaces, a suitable combination of inputs is acceptable in lieu of recording each surface separately. For aeroplanes that have a flight control break-away capability that allows either pilot to operate the controls independently, record both inputs):
18a	Pitch axis
18b	Roll axis
18c	Yaw axis
19	Pitch trim surface position
23	Marker beacon passage
24	Warnings — in addition to the master warning, each 'red' warning that cannot be determined from other parameters or from the CVR and each smoke warning from other compartments should be recorded.
25	Each navigation receiver frequency selection
27	Air-ground status. Air-ground status and a sensor of each landing gear if installed

* The number in the left-hand column reflects the serial number depicted in EUROCAE Document 112A.

Table 2: FDR — Aeroplanes for which the data source for the parameter is either used by the aeroplane systems or is available on the instrument panel for use by the flight crew to operate the aeroplane

No*	Parameter
10	Flaps:
10a	Trailing edge flap position
10b	Flight crew compartment control selection
11	Slats:
11a	Leading edge flap (slat) position
11b	Flight crew compartment control selection
12	Thrust reverse status
13	Ground spoiler and speed brake:

No*	Parameter
13a	Ground spoiler position
13b	Ground spoiler selection
13c	Speed brake position
13d	Speed brake selection
15	Autopilot, autothrottle and automatic flight control system (AFCS): mode and engagement status (showing which systems are engaged and which primary modes are controlling the flight path and speed of the aircraft)
20	Radio altitude. For auto-land/category III operations, each radio altimeter should be recorded.
21	Vertical deviation — the approach aid in use should be recorded. For auto-land/category III operations, each system should be recorded:
21a	ILS/GPS/GLS glide path
21b	MLS elevation
21c	Integrated approach navigation (IAN)/Integrated Area Navigation (IRNAV), vertical deviation
22	Horizontal deviation — the approach aid in use should be recorded. For auto-land/category III operations, each system should be recorded:
22a	ILS/GPS/GLS localiser
22b	MLS azimuth
22c	Integrated approach navigation (IAN) /Integrated Area Navigation IRNAV lateral deviation, vertical deviation
26	Distance measuring equipment (DME) 1 and 2 distances:
26a	Distance to runway threshold (GLS)
26b	Distance to missed approach point (IRNAV/IAN)
28	Ground proximity warning system (GPWS)/terrain awareness warning system (TAWS)/ground collision avoidance system (GCAS) status — a suitable combination of discrettes unless recorder capacity is limited in which case a single discrete for all modes is acceptable:
28a	Selection of terrain display mode, including pop-up display status
28b	Terrain alerts, including cautions and warnings and advisories
28c	On/off switch position
29	Angle of attack
30	Low pressure warning (each system):
30a	Hydraulic pressure

No*	Parameter
30b	Pneumatic pressure
31	Ground speed
32	Landing gear:
32a	Landing gear position
32b	Gear selector position
33	Navigation data:
33a	Drift angle
33b	Wind speed
33c	Wind direction
33d	Latitude
33e	Longitude
33f	GNSS augmentation in use
34	Brakes:
34a	Left and right brake pressure
34b	Left and right brake pedal position
35	Additional engine parameters (if not already recorded in Parameter 9 of Table 1, and if the aeroplane is equipped with a suitable data source):
35a	Engine pressure ratio (EPR)
35b	N1
35c	Indicated vibration level
35d	N2
35e	Exhaust gas temperature (EGT)
35f	Fuel flow
35g	Fuel cut-off lever position
35h	N3
35i	Engine fuel metering valve position (or equivalent parameter from the system that directly controls the flow of fuel into the engine) — for aeroplanes type certified before 1 January 2023, to be recorded only if this does not require extensive modification.
36	Traffic alert and collision avoidance system (TCAS)/airborne collision avoidance system (ACAS) — a suitable combination of discretely should be recorded to determine the status of the system:
36a	Combined control
36b	Vertical control

No*	Parameter
36c	Up advisory
36d	Down advisory
36e	Sensitivity level
37	Wind shear warning
38	Selected barometric setting — to be recorded for the aeroplane where the parameter is displayed electronically:
38a	Pilot selected barometric setting
38b	Co-pilot selected barometric setting
39	Selected altitude (all pilot selectable modes of operation) — to be recorded for the aeroplane where the parameter is displayed electronically
40	Selected speed (all pilot selectable modes of operation) — to be recorded for the aeroplane where the parameter is displayed electronically
41	Selected Mach (all pilot selectable modes of operation) — to be recorded for the aeroplane where the parameter is displayed electronically
42	Selected vertical speed (all pilot selectable modes of operation) — to be recorded for the aeroplane where the parameter is displayed electronically
43	Selected heading (all pilot selectable modes of operation) — to be recorded for the aeroplane where the parameter is displayed electronically
44	Selected flight path (all pilot selectable modes of operation) — to be recorded for the aeroplane where the parameter is displayed electronically:
44a	Course/desired track (DSTRK)
44b	Path angle
44c	Coordinates of final approach path (IRNAV/IAN)
45	Selected decision height — to be recorded for the aeroplane where the parameter is displayed electronically
46	Electronic flight instrument system (EFIS) display format, showing the display system status:
46a	Pilot
46b	Co-pilot
47	Multi-function/engine/alerts display format, showing the display system status
48	Alternating current (AC) electrical bus status — each bus
49	Direct current (DC) electrical bus status — each bus
50	Engine bleed valve(s) position

No*	Parameter
51	Auxiliary power unit (APU) bleed valve(s) position
52	Computer failure — all critical flight and engine control systems
53	Engine thrust command
54	Engine thrust target
55	Computed centre of gravity (CG)
56	Fuel quantity in CG trim tank
57	Head-up display in use
58	Paravisual display on
59	Operational stall protection, stick shaker and pusher activation
60	Primary navigation system reference:
60a	GNSS
60b	Inertial navigational system (INS)
60c	VHF omnidirectional radio range (VOR)/distance measuring equipment (DME)
60d	MLS
60e	Loran C
60f	ILS
61	Ice detection
62	Engine warning — each engine vibration
63	Engine warning — each engine over temperature
64	Engine warning — each engine oil pressure low
65	Engine warning — each engine overspeed
66	Yaw trim surface position
67	Roll trim surface position
68	Yaw or sideslip angle
69	De-icing and/or anti-icing systems selection
70	Hydraulic pressure — each system
71	Loss of cabin pressure

No*	Parameter
72	Trim control input position in the flight crew compartment, pitch — when mechanical means for control inputs are not available, displayed trim position or trim command should be recorded.
73	Trim control input position in the flight crew compartment, roll — when mechanical means for control inputs are not available, displayed trim position or trim command should be recorded.
74	Trim control input position in the flight crew compartment, yaw — when mechanical means for control inputs are not available, displayed trim position or trim command should be recorded.
75	All flight control input forces (for fly-by-wire flight control systems, where control surface position is a function of the displacement of the control input device only, it is not necessary to record this parameter):
75a	Control wheel input forces
75b	Control column input forces
75c	Rudder pedal input forces
76	Event marker
77	Date
78	Actual navigation performance (ANP) or estimate of position error (EPE) or estimate of position uncertainty (EPU)
79	Cabin pressure altitude — for aeroplanes type certified before 1 January 2023, to be recorded only if this does not require extensive modification
80	Aeroplane computed weight — for aeroplanes type certified before 1 January 2023, to be recorded only if this does not require extensive modification
81	Flight director command:
81a	Left flight director pitch command — for aeroplanes type certified before 1 January 2023, to be recorded only if this does not require extensive modification
81b	Left flight director roll command — for aeroplanes type certified before 1 January 2023, to be recorded only if this does not require extensive modification
81c	Right flight director pitch command — for aeroplanes type certified before 1 January 2023, to be recorded only if this does not require extensive modification
81d	Right flight director roll command — for aeroplanes type certified before 1 January 2023, to be recorded only if this does not require extensive modification
82	Vertical speed — for aeroplanes type certified before 1 January 2023, to be recorded only if this does not require extensive modification

* The number in the left-hand column reflects the serial number depicted in EUROCAE Document 112A.

SPO.IDE.A.150 Data link recording

- (a) Aeroplanes first issued with an individual CofA on or after 1 January 2016 that have the capability to operate data link communications and are required to be equipped with a CVR shall record on a recorder, where applicable:
- (1) data link communication messages related to ATS communications to and from the aeroplane, including messages applying to the following applications:
 - (i) data link initiation;
 - (ii) controller-pilot communication;
 - (iii) addressed surveillance;
 - (iv) flight information;
 - (v) as far as is practicable, given the architecture of the system, aircraft broadcast surveillance;
 - (vi) as far as is practicable, given the architecture of the system, aircraft operational control data; and
 - (vii) as far as is practicable, given the architecture of the system, graphics;
 - (2) information that enables correlation to any associated records related to data link communications and stored separately from the aeroplane; and
 - (3) information on the time and priority of data link communications messages, taking into account the system's architecture.
- (b) The recorder shall use a digital method of recording and storing data and information and a method for readily retrieving that data. The recording method shall allow the data to match the data recorded on the ground.
- (c) The recorder shall be capable of retaining data recorded for at least the same duration as set out for CVRs in SPO.IDE.A.140.
- (d) If the recorder is not deployable, it shall have a device to assist in locating it under water. By 1 January 2020 at the latest, this device shall have a minimum underwater transmission time of 90 days. If the recorder is deployable, it shall have an automatic emergency locator transmitter.
- (e) The requirements applicable to the start and stop logic of the recorder are the same as the requirements applicable to the start and stop logic of the CVR contained in SPO.IDE.A.140 (d) and (e).

AMC1 SPO.IDE.A.150 Data link recording

GENERAL

- (a) As a means of compliance with SPO.IDE.A.150 (a) the recorder on which the data link messages are recorded may be:
- (1) the CVR;
 - (2) the FDR;
 - (3) a combination recorder when SPO.IDE.A.155 is applicable; or
 - (4) a dedicated flight recorder. In that case, the operational performance requirements for this recorder should be those laid down in EUROCAE Document ED-112 (Minimum Operational Performance Specification for Crash Protected Airborne Recorder Systems),

dated March 2003, including amendments No°1 and No 2, or any later equivalent standard produced by EUROCAE.

- (b) As a means of compliance with SPO.IDE.A.150 (a)(2) the operator should enable correlation by providing information that allows an accident investigator to understand what data was provided to the aircraft and, when the provider identification is contained in the message, by which provider.
- (c) The timing information associated with the data link communications messages required to be recorded by SPO.IDE.A.150 (a)(3) should be capable of being determined from the airborne-based recordings. This timing information should include at least the following:
- (1) the time each message was generated;
 - (2) the time any message was available to be displayed by the flight crew;
 - (3) the time each message was actually displayed or recalled from a queue; and
 - (4) the time of each status change.
- (d) The message priority should be recorded when it is defined by the protocol of the data link communication message being recorded.
- (e) The expression ‘taking into account the system’s architecture’, in SPO.IDE.A.150 (a)(3), means that the recording of the specified information may be omitted if the existing source systems involved would require a major upgrade. The following should be considered:
- (1) the extent of the modification required;
 - (2) the down-time period; and
 - (3) equipment software development.
- (f) Data link communications messages that support the applications in Table 1 below should be recorded.
- (g) Further details on the recording requirements can be found in the recording requirement matrix in Appendix D.2 of EUROCAE Document ED-93 (Minimum Aviation System Performance Specification for CNS/ATM Recorder Systems), dated November 1998.

Table 1: Data link recording

Item No	Application Type	Application Description	Required Recording Content
1	Data link initiation	This includes any application used to log on to, or initiate, a data link service. In future air navigation system (FANS)-1/A and air traffic navigation (ATN), these are ATS facilities notification (AFN) and context management (CM), respectively.	C
2	Controller/pilot communication	This includes any application used to exchange requests, clearances, instructions and reports between the flight crew and controllers on the ground. In FANS-1/A and ATN, this includes the controller pilot data link communications (CPDLC) application.	C

Item No	Application Type	Application Description	Required Recording Content
		It also includes applications used for the exchange of oceanic clearances (OCL) and departure clearances (DCL), as well as data link delivery of taxi clearances.	
3	Addressed surveillance	This includes any surveillance application in which the ground sets up contracts for delivery of surveillance data. In FANS-1/A and ATN, this includes the automatic dependent surveillance-contract (ADS-C) application.	C, F2
4	Flight information	This includes any application used for delivery of flight information data to specific aeroplanes. This includes for example digital automatic terminal information service (D ATIS), data link operational terminal information service (D OTIS), digital weather information services (data link-meteorological aerodrome or aeronautical report (D-METAR) or terminal weather information for pilots (TWIP)), data link flight information service (D-FIS), and Notice to Airmen (electronic NOTAM) delivery.	C
5	Broadcast surveillance	This includes elementary and enhanced surveillance systems, as well as automatic dependent surveillance-broadcast (ADS-B) output data.	M*, F2
6	Aeronautical operational control (AOC) data	This includes any application transmitting or receiving data used for AOC purposes (in accordance with the ICAO definition of AOC). Such systems may also process aeronautical administrative communication (AAC) messages, but there is no requirement to record AAC messages	M*
7	Graphics	This includes any application receiving graphical data to be used for operational purposes (i.e. excluding applications that are receiving such things as updates to manuals).	M* F1

GM1 SPO.IDE.A.150 Data link recording

GENERAL

- (a) The letters and expressions in Table 1 of AMC1 SPO.IDE.A.150 have the following meaning:
- (1) C: complete contents recorded.
 - (2) M: information that enables correlation with any associated records stored separately from the aeroplane.
 - (3) *: applications that are to be recorded only as far as is practicable, given the architecture of the system.
 - (4) F1: graphics applications may be considered as AOC messages when they are part of a data link communications application service run on an individual basis by the operator itself in the framework of the operational control.
 - (5) F2: where parametric data sent by the aeroplane, such as Mode S, is reported within the message, it should be recorded unless data from the same source is recorded on the FDR.
- (b) The definitions of the applications type in Table 1 of AMC1 SPO.IDE.A.150 are described in Table 1 below.

Table 1: Definitions of the applications type

Item No	Application Type	Messages	Comments
1	CM		CM is an ATN service
2	AFN		AFN is a FANS 1/A service
3	CPDLC		All implemented up and downlink messages to be recorded
4	ADS-C	ADS-C reports	All contract requests and reports recorded
		Position reports	Only used within FANS 1/A. Mainly used in oceanic and remote areas.
5	ADS-B	Surveillance data	Information that enables correlation with any associated records stored separately from the aeroplane.
6	D-FIS		D-FIS is an ATN service. All implemented up and downlink messages to be recorded
7	TWIP	TWIP messages	Terminal weather information for pilots
8	D-ATIS	ATIS messages	Refer to EUROCAE ED-89A, dated December 2003: Data Link Application System Document (DLASD) for the 'ATIS' data link service
9	OCL	OCL messages	Refer to EUROCAE ED-106A, dated March 2004: Data Link Application System Document

			(DLASD) for 'Oceanic Clearance' (OCL) data link service
10	DCL	DCL messages	Refer to EUROCAE ED-85A, dated December 2005: Data Link Application System Document (DLASD) for 'Departure Clearance' data link service
11	Graphics	Weather maps & other graphics	Graphics exchanged in the framework of procedures within the operational control, as specified in Part-ORO. Information that enables correlation with any associated records stored separately from the aeroplane.
12	AOC	Aeronautical operational control messages	Messages exchanged in the framework of procedures within the operational control, as specified in Part-ORO. Information that enables correlation with any associated records stored separately from the aeroplane. Definition in EUROCAE ED-112, dated March 2003.
13	Surveillance	Downlinked aircraft parameters (DAP)	As defined in ICAO Annex 10 Volume IV (Surveillance systems and ACAS).

AAC	aeronautical administrative communications
ADS-B	automatic dependent surveillance — broadcast
ADS-C	automatic dependent surveillance — contract
AFN	aircraft flight notification
AOC	aeronautical operational control
ATIS	automatic terminal information service
ATSC	air traffic service communication
CAP	controller access parameters
CPDLC	controller pilot data link communications
CM	configuration/context management
D-ATIS	digital ATIS
D-FIS	data link flight information service
D-METAR	data link meteorological airport report
DCL	departure clearance
FANS	Future Air Navigation System
FLIPCY	flight plan consistency
OCL	oceanic clearance

SAP	system access parameters
TWIP	terminal weather information for pilots

GM1 SPO.IDE.A.150(a) Data link recording

APPLICABILITY OF THE DATA LINK RECORDING REQUIREMENT

- (a) If it is certain that the aeroplane cannot use data link communication messages for ATS communications corresponding to any application designated by SPO.IDE.A.150(a)(1), then the data link recording requirement does not apply.
- (b) Examples where the aeroplane cannot use data link communication messages for ATS communications include but are not limited to the cases where:
 - (1) the aeroplane data link communication capability is disabled permanently and in a way that it cannot be enabled again during the flight;
 - (2) data link communications are not used to support air traffic service (ATS) in the area of operation of the aeroplane; and
 - (3) the aeroplane data link communication equipment cannot communicate with the equipment used by ATS in the area of operation of the aeroplane.

SPO.IDE.A.155 Flight data and cockpit voice combination recorder

Compliance with CVR requirements and FDR requirements may be achieved by:

- (a) one flight data and cockpit voice combination recorder if the aeroplane has to be equipped with a CVR or an FDR; or
- (b) two flight data and cockpit voice combination recorders if the aeroplane has to be equipped with a CVR and an FDR.

AMC1 SPO.IDE.A.155 Flight data and cockpit voice combination recorder

GENERAL

When two flight data and cockpit voice combination recorders are installed, one should be located near the flight crew compartment in order to minimise the risk of data loss due to a failure of the wiring that gathers data to the recorder. The other should be located at the rear section of the aeroplane, in order to minimise the risk of data loss due to recorder damage in the case of a crash.

GM1 SPO.IDE.A.155 Flight data and cockpit voice combination recorder

GENERAL

- (a) A flight data and cockpit voice combination recorder is a flight recorder that records:
 - (1) all voice communications and the aural environment required by SPO.IDE.A.140; and
 - (2) all parameters and specifications required by SPO.IDE.A.145,with the same specifications required by SPO.IDE.A.140 and SPO.IDE.A.145.
- (b) In addition a flight data and cockpit voice combination recorder may record data link communication messages and related information required by SPO.IDE.A.150.

SPO.IDE.A.160 Seats, seat safety belts and restraint systems

Aeroplanes shall be equipped with:

- (a) a seat or station for each crew member or task specialist on board;
- (b) a seat belt on each seat, and restraint devices for each station;
- (c) for other-than-complex motor-powered aeroplanes, a seat belt with upper torso restraint system on each flight crew seat, having a single point release for aeroplanes having a CofA first issued on or after 25 August 2016;
- (d) for complex motor-powered aeroplanes, a seat belt with upper torso restraint system, incorporating a device that will automatically restrain the occupant's torso in the event of rapid deceleration:
 - (1) on each flight crew seat and on any seat alongside a pilot's seat; and
 - (2) on each observer's seat located in the flight crew compartment.
- (e) The seat belt with upper torso restraint system required by (d) shall have:
 - (1) a single point release;
 - (2) on flight crew seats and on any seat alongside a pilot's seat:
 - (i) two shoulder straps and a seat belt that may be used independently; or
 - (ii) a diagonal shoulder strap and a seat belt that may be used independently for the following aeroplanes:
 - (A) aeroplanes with an MCTOM of less than 5 700 kg and with an MOPSC of less than nine that are compliant with the emergency landing dynamic conditions defined in the applicable certification specification;
 - (B) aeroplanes with an MCTOM of less than 5 700 kg and with an MOPSC of less than nine that are not compliant with the emergency landing dynamic conditions defined in the applicable certification specification and having an individual CofA first issued before 25 August 2016.

AMC1 SPO.IDE.A.160 Seats, seat safety belts and restraint systems**UPPER TORSO RESTRAINT SYSTEM FOR OTHER-THAN COMPLEX MOTOR-POWERED AEROPLANES**

- (a) The following systems are deemed to be compliant with the requirement for an upper torso restraint system:
 - (1) A seat belt with a diagonal shoulder strap;
 - (2) A restraint system having a seat belt and two shoulder straps that may be used independently; and
 - (3) A restraint system having a seat belt, two shoulder straps and additional straps that may be used independently.
- (b) The use of the upper torso restraint independently from the use of the seat belt is intended as an option for the comfort of the occupant of the seat in those phases of flight where only the seat belt is required to be fastened. A restraint system including a seat belt and an upper torso restraint that both remain permanently fastened is also acceptable.

UPPER TORSO RESTRAINT SYSTEM FOR COMPLEX MOTOR-POWERED AEROPLANES

- (a) A restraint system, including a seat belt, two shoulder straps and additional straps is deemed to be compliant with the requirement for restraint systems with two shoulder straps.
- (b) An upper torso restraint system which restrains permanently the torso of the occupant is deemed to be compliant with the requirement for an upper torso restraint system incorporating a device that will automatically restrain the occupant's torso in the event of rapid deceleration.
- (c) The use of the upper torso restraint independently from the use of the seat belt is intended as an option for the comfort of the occupant of the seat in those phases of flight where only the seat belt is required to be fastened. A restraint system including a seat belt and an upper torso restraint that both remain permanently fastened is also acceptable.

SEAT BELT

A seat belt with a diagonal shoulder strap (three anchorage points) is deemed to be compliant with the requirement for a seat belt (two anchorage points).

GM1 SPO.IDE.A.160 Seats, seat safety belts, restraint systems**EMERGENCY LANDING DYNAMIC CONDITIONS**

Emergency landing dynamic conditions are defined in 23.562 of CS-23 or equivalent and in 25.562 of CS-25 or equivalent.

SPO.IDE.A.165 First-aid kit

- (a) Aeroplanes shall be equipped with a first-aid kit.
- (b) The first-aid kit shall be:
 - (1) readily accessible for use; and
 - (2) kept up-to-date.

AMC1 SPO.IDE.A.165 First-aid kit

CONTENT OF FIRST-AID KITS — OTHER-THAN COMPLEX MOTOR-POWERED AEROPLANES

- (a) First-aid kits (FAKs) should be equipped with appropriate and sufficient medications and instrumentation. However, these kits should be amended by the operator according to the characteristics of the operation (scope of operation, flight duration, number and demographics of passengers, etc.).
- (b) The following should be included in the FAKs:
 - (1) bandages (assorted sizes),
 - (2) burns dressings (large and small),
 - (3) wound dressings (large and small),
 - (4) adhesive dressings (assorted sizes),
 - (5) antiseptic wound cleaner,
 - (6) safety scissors, and
 - (7) disposable gloves.

AMC2 SPO.IDE.A.165 First-aid kit

CONTENT OF FIRST-AID KITS — COMPLEX MOTOR-POWERED AEROPLANES

- (a) First-aid kits should be equipped with appropriate and sufficient medications and instrumentation. However, these kits should be amended by the operator according to the characteristics of the operation (scope of operation, flight duration, number and demographics of persons on board etc.).
- (b) The following should be included in the FAKs:
 - (1) Equipment:
 - (i) bandages (assorted sizes);
 - (ii) burns dressings (unspecified);
 - (iii) wound dressings (large and small);
 - (iv) adhesive dressings (assorted sizes);
 - (v) adhesive tape;
 - (vi) adhesive wound closures;
 - (vii) safety pins;
 - (viii) safety scissors;
 - (ix) antiseptic wound cleaner;

- (x) disposable resuscitation aid;
 - (xi) disposable gloves;
 - (xii) tweezers: splinter; and
 - (xiii) thermometers (non-mercury).
- (2) Medications:
- (i) simple analgesic (may include liquid form);
 - (ii) antiemetic;
 - (iii) nasal decongestant;
 - (iv) gastrointestinal antacid, in the case of aeroplanes carrying more than nine persons;
 - (v) anti-diarrhoeal medication, in the case of aeroplanes carrying more than nine persons; and
 - (vi) antihistamine.
- (3) Other:
- (i) a list of contents in at least two languages (English and one other). This should include information on the effects and side effects of medications carried;
 - (ii) first-aid handbook, current edition;
 - (iii) medical incident report form; and
 - (iv) biohazard disposal bags.
- (4) An eye irrigator, although not required to be carried in the FAK, should, where possible, be available for use on the ground.

AMC3 SPO.IDE.A.165 First-aid kit

MAINTENANCE OF FIRST-AID KIT

To be kept up to date, the first-aid kit should be:

- (a) inspected periodically to confirm, to the extent possible, that contents are maintained in the condition necessary for their intended use;
- (b) replenished at regular intervals, in accordance with instructions contained on their labels, or as circumstances warrant; and
- (c) replenished after use in-flight at the first opportunity where replacement items are available.

SPO.IDE.A.170 Supplemental oxygen — pressurised aeroplanes

- (a) Pressurised aeroplanes operated at flight altitudes for which the oxygen supply is required in accordance with (b) shall be equipped with oxygen storage and dispensing apparatus capable of storing and dispensing the required oxygen supplies.
- (b) Pressurised aeroplanes operated above flight altitudes at which the pressure altitude in the cabin compartments is above 10 000 ft shall carry enough breathing oxygen to supply all crew members and task specialists at least:
 - (1) for any period when the cabin pressure altitude exceeds 15 000 ft, but in no case less than 10 minutes' supply;
 - (2) for any period when, in the event of loss of pressurisation and taking into account the circumstances of the flight, the pressure altitude in the flight crew and cabin compartment will be between 14 000 ft and 15 000 ft;
 - (3) for any period in excess of 30 minutes when the pressure altitude in the flight crew and cabin compartment will be between 10 000 ft and 14 000 ft; and
 - (4) for no less than 10 minutes, in the case of aeroplanes operated at pressure altitudes above 25 000 ft, or operated below that altitude, but under conditions that will not allow them to descend safely to a pressure altitude of 13 000 ft within 4 minutes.
- (c) Pressurised aeroplanes operated at flight altitudes above 25 000 ft shall, in addition, be equipped with:
 - (1) a device to provide a warning indication to the flight crew of any loss of pressurisation; and
 - (2) in the case of complex motor-powered aeroplanes, quick donning masks for flight crew members.

AMC1 SPO.IDE.A.170 Supplemental oxygen — pressurised aeroplanes

DETERMINATION OF OXYGEN

- (a) In the determination of oxygen for the routes to be flown, it is assumed that the aeroplane will descend in accordance with the emergency procedures specified in the AFM, without exceeding its operating limitations, to a flight altitude that will allow the flight to be completed safely (i.e. flight altitudes ensuring adequate terrain clearance, navigational accuracy, hazardous weather avoidance, etc.).
- (b) The amount of oxygen should be determined on the basis of cabin pressure altitude, flight duration and on the assumption that a cabin pressurisation failure will occur at the pressure altitude or point of flight that is most critical from the standpoint of oxygen need.
- (c) Following a cabin pressurisation failure, the cabin pressure altitude should be considered to be the same as the aeroplane pressure altitude unless it can be demonstrated to the competent authority that no probable failure of the cabin or pressurisation system will result in a cabin pressure altitude equal to the aeroplane pressure altitude. Under these circumstances, the demonstrated maximum cabin pressure altitude may be used as a basis for determination of oxygen supply.

GM1 SPO.IDE.A.170(c)(2) Supplemental oxygen — pressurised aeroplanes

QUICK DONNING MASKS

A quick donning mask is a type of mask that:

- (a) can be placed on the face from its ready position, properly secured, sealed and supplying oxygen upon demand, with one hand and within 5 seconds and will thereafter remain in position, both hands being free;
- (b) can be donned without disturbing eye glasses and without delaying the flight crew member from proceeding with assigned emergency duties;
- (c) once donned, does not prevent immediate communication between the flight crew members and other crew members over the aircraft intercommunication system; and
- (d) does not inhibit radio communications.

SPO.IDE.A.175 Supplemental oxygen — non-pressurised aeroplanes

- (a) Non-pressurised aeroplanes operated at flight altitudes when the oxygen supply is required in accordance with (b) shall be equipped with oxygen storage and dispensing apparatus capable of storing and dispensing the required oxygen supplies.
- (b) Non-pressurised aeroplanes operated above flight altitudes at which the pressure altitude in the cabin compartments is above 10 000 ft shall carry enough breathing oxygen to supply:
 - (1) all crew members for any period in excess of 30 minutes when the pressure altitude in the cabin compartment will be between 10 000 ft and 13 000 ft; and
 - (2) all persons on board for any period that the pressure altitude in the cabin compartment will be above 13 000 ft.
- (c) Notwithstanding (b), excursions of a specified duration between 13 000 ft and 16 000 ft may be undertaken without oxygen supplies, in accordance with SPO.OP.195(b).

AMC1 SPO.IDE.A.175 Supplemental oxygen — non-pressurised aeroplanes

DETERMINATION OF OXYGEN

- (a) In the determination of oxygen for the routes to be flown, it is assumed that the aeroplane will descend in accordance with the emergency procedures specified in the AFM, without exceeding its operating limitations, to a flight altitude that will allow the flight to be completed safely (i.e. flight altitudes ensuring adequate terrain clearance, navigational accuracy, hazardous weather avoidance etc.).
- (b) The amount of oxygen should be determined on the basis of cabin pressure altitude and flight duration.

SPO.IDE.A.180 Hand fire extinguishers

- (a) Aeroplanes, except touring motor gliders (TMG) and ELA1 aeroplanes, shall be equipped with at least one hand fire extinguisher:
 - (1) in the flight crew compartment; and
 - (2) in each cabin compartment that is separate from the flight crew compartment, except if the compartment is readily accessible to the flight crew.
- (b) The type and quantity of extinguishing agent for the required fire extinguishers shall be suitable for the type of fire likely to occur in the compartment where the extinguisher is intended to be used and to minimise the hazard of toxic gas concentration in compartments occupied by persons.

AMC1 SPO.IDE.A.180 Hand fire extinguishers

NUMBER, LOCATION AND TYPE

- (a) The number and location of hand fire extinguishers should be such as to provide adequate availability for use, account being taken of the number and size of the cabin compartments, the need to minimise the hazard of toxic gas concentrations and the location of toilets, galleys, etc. These considerations may result in the number of fire extinguishers being greater than the minimum required.
- (b) There should be at least one hand fire extinguisher installed in the flight crew compartment and this should be suitable for fighting both flammable fluid and electrical equipment fires. Additional hand fire extinguishers may be required for the protection of other compartments accessible to the flight crew or task specialist in flight. Dry chemical fire extinguishers should not be used in the flight crew compartment, or in any compartment not separated by a partition from the flight crew compartment, because of the adverse effect on vision during discharge and, if conductive, interference with electrical contacts by the chemical residues.
- (c) Where only one hand fire extinguisher is required in the cabin compartments, it should be located near the task specialist's station, where provided.
- (d) Where two or more hand fire extinguishers are required in the cabin compartments and their location is not otherwise dictated by consideration of (a), an extinguisher should be located near each end of the cabin with the remainder distributed throughout the cabin as evenly as is practicable.
- (e) Unless an extinguisher is clearly visible, its location should be indicated by a placard or sign. Appropriate symbols may also be used to supplement such a placard or sign.

SPO.IDE.A.181 Crash axe and crowbar

Aeroplanes with an MCTOM of more than 5 700 kg shall be equipped with at least one crash axe or crowbar located in the flight crew compartment.

SPO.IDE.A.185 Marking of break-in points

If areas of the aeroplane's fuselage suitable for break-in by rescue crews in an emergency are marked, such areas shall be marked as shown in Figure 1.

Figure 1

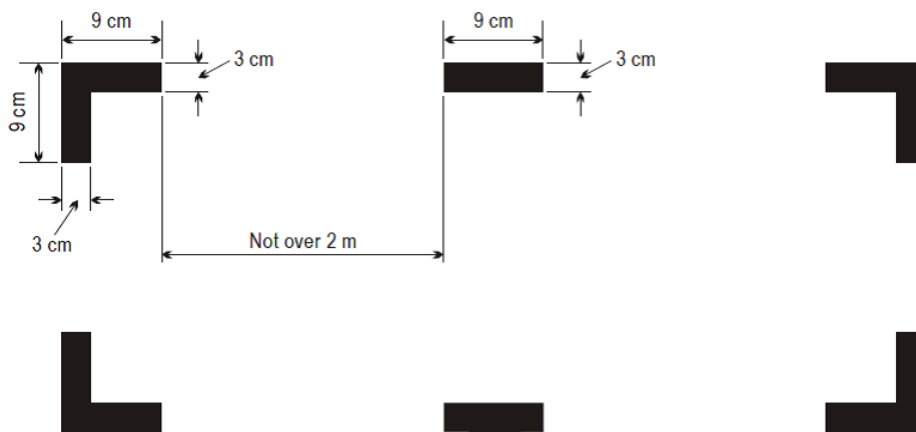
Marking of break-in points**AMC1 SPO.IDE.A.185 Marking of break-in points****COLOUR AND CORNERS' MARKING**

- (a) The colour of the markings should be red or yellow and, if necessary, should be outlined in white to contrast with the background.
- (b) If the corner markings are more than 2 m apart, intermediate lines 9 cm x 3 cm should be inserted so that there is no more than 2 m between adjacent markings.

SPO.IDE.A.190 Emergency locator transmitter (ELT)

- (a) Aeroplanes shall be equipped with:
- (1) an ELT of any type or an aircraft localisation means meeting the requirement of Annex IV (Part CAT), CAT.GEN.MPA.210, to Regulation (EU) No 965/2012, when first issued with an individual CofA on or before 1 July 2008;
 - (2) an automatic ELT or an aircraft localisation means meeting the requirement of Annex IV (Part CAT), CAT. GEN.MPA.210, to Regulation (EU) No 965/2012, when first issued with an individual CofA after 1 July 2008; or
 - (3) a survival ELT (ELT(S)) or a personal locator beacon (PLB), carried by a crew member or a task specialist, when certified for a maximum seating configuration of six or less.
- (b) ELTs of any type and PLBs shall be capable of transmitting simultaneously on 121,5 MHz and 406 MHz.

AMC1 SPO.IDE.A.190 Emergency locator transmitter (ELT)

BATTERIES

- (a) All batteries used in ELTs or PLBs should be replaced (or recharged, if the battery is rechargeable) when the equipment has been in use for more than 1 cumulative hour or in the following cases:
- (1) Batteries specifically designed for use in ELTs and having an airworthiness release certificate (EASA Form 1 or equivalent) should be replaced (or recharged, if the battery is rechargeable) before the end of their useful life in accordance with the maintenance instructions applicable to the ELT.
 - (2) Standard batteries manufactured in accordance with an industry standard and not having an airworthiness release certificate (EASA Form 1 or equivalent), when used in ELTs should be replaced (or recharged, if the battery is rechargeable) when 50 % of their useful life (or for rechargeable, 50 % of their useful life of charge), as established by the battery manufacturer, has expired.
 - (3) All batteries used in PLBs should be replaced (or recharged, if the battery is rechargeable) when 50 % of their useful life (or for rechargeable, 50 % of their useful life of charge), as established by the battery manufacturer, has expired.
 - (4) The battery useful life (or useful life of charge) criteria in (1),(2) and (3) do not apply to batteries (such as water-activated batteries) that are essentially unaffected during probable storage intervals.
- (b) The new expiry date for a replaced (or recharged) battery should be legibly marked on the outside of the equipment.

AMC2 SPO.IDE.A.190 Emergency locator transmitter (ELT)

TYPES OF ELT AND GENERAL TECHNICAL SPECIFICATIONS

- (a) The ELT required by this provision should be one of the following:
- (1) Automatic fixed (ELT(AF)). An automatically activated ELT that is permanently attached to an aircraft and is designed to aid search and rescue (SAR) teams in locating the crash site.
 - (2) Automatic portable (ELT(AP)). An automatically activated ELT that is rigidly attached to an aircraft before a crash, but is readily removable from the aircraft after a crash. It functions

as an ELT during the crash sequence. If the ELT does not employ an integral antenna, the aircraft-mounted antenna may be disconnected and an auxiliary antenna (stored on the ELT case) attached to the ELT. The ELT can be tethered to a survivor or a life-raft. This type of ELT is intended to aid SAR teams in locating the crash site or survivor(s).

- (3) Automatic deployable (ELT(AD)). An ELT that is rigidly attached to the aircraft before the crash and that is automatically ejected, deployed and activated by an impact, and, in some cases, also by hydrostatic sensors. Manual deployment is also provided. This type of ELT should float in water and is intended to aid SAR teams in locating the crash site.
 - (4) Survival ELT (ELT(S)). An ELT that is removable from an aircraft, stowed so as to facilitate its ready use in an emergency and manually activated by a survivor. An ELT(S) may be activated manually or automatically (e.g. by water activation). It should be designed to be tethered to a life-raft or a survivor.
- (b) To minimise the possibility of damage in the event of crash impact, the automatic ELT should be rigidly fixed to the aircraft structure, as far aft as is practicable, with its antenna and connections arranged so as to maximise the probability of the signal being transmitted after a crash.
 - (c) Any ELT carried should operate in accordance with the relevant provisions of ICAO Annex 10, Volume III and should be registered with the national agency responsible for initiating search and rescue or other nominated agency.

AMC3 SPO.IDE.A.190 Emergency locator transmitter (ELT)

PLB TECHNICAL SPECIFICATIONS

- (a) A personal locator beacon (PLB) should have a built-in GNSS receiver with a *cosmicheskaya sistyema poiska avariynich sudov* — search and rescue satellite-aided tracking (COSPAS-SARSAT) type approval number. However, devices with a COSPAS-SARSAT with a number belonging to series 700 are excluded as this series of numbers identifies the special-use beacons not meeting all the technical requirements and all the tests specified by COSPAS-SARSAT.
- (b) Any PLB carried should be registered with the national agency responsible for initiating search and rescue or other nominated agency.

BRIEFING ON PLB USE

When a PLB is carried by a task specialist, he/she should be briefed on its characteristics and use by the pilot-in-command before the flight.

GM1 SPO.IDE.A.190 Emergency locator transmitter (ELT)

TERMINOLOGY

- (a) An ELT is a generic term describing equipment that broadcasts distinctive signals on designated frequencies and, depending on application, may be activated by impact or may be manually activated.
- (b) A PLB is an emergency beacon other than an ELT that broadcasts distinctive signals on designated frequencies, is standalone, portable and is manually activated by the survivors.

GM2 SPO.IDE.A.190 Emergency locator transmitter (ELT)

MAXIMUM CERTIFIED SEATING CONFIGURATION

The maximum certified seating configuration does not include flight crew seats.

SPO.IDE.A.195 Flight over water

- (a) The following aeroplanes shall be equipped with a life-jacket for each person on board, that shall be worn or stowed in a position that is readily accessible from the seat or station of the person for whose use it is provided:
- (1) single-engine landplanes when:
 - (i) flying over water beyond gliding distance from land; or
 - (ii) taking off or landing at an aerodrome or operating site where, in the opinion of the pilot-in-command, the take-off or approach path is so disposed over water that there would be a likelihood of a ditching;
 - (2) seaplanes operated over water; and
 - (3) aeroplanes operated at a distance away from land where an emergency landing is possible greater than that corresponding to 30 minutes at normal cruising speed or 50 NM, whichever is less.
- (b) Each life-jacket shall be equipped with a means of electric illumination for the purpose of facilitating the location of persons.
- (c) Seaplanes operated over water shall be equipped with:
- (1) a sea anchor and other equipment necessary to facilitate mooring, anchoring or manoeuvring the aeroplane on water, appropriate to its size, weight and handling characteristics; and
 - (2) equipment for making the sound signals as prescribed in the International Regulations for Preventing Collisions at Sea, where applicable.
- (d) The pilot-in-command of an aeroplane operated at a distance away from land where an emergency landing is possible greater than that corresponding to 30 minutes at normal cruising speed or 50 NM, whichever is the lesser, shall determine the risks to survival of the occupants of the aeroplane in the event of a ditching, based on which he/she shall determine the carriage of:
- (1) equipment for making the distress signals;
 - (2) life-rafts in sufficient numbers to carry all persons on board, stowed so as to facilitate their ready use in emergency; and
 - (3) life-saving equipment, to provide the means of sustaining life, as appropriate to the flight to be undertaken.

AMC1 SPO.IDE.A.195 Flight over water**ACCESSIBILITY OF LIFE-JACKETS**

The life-jacket, if not worn, should be accessible from the seat or station of the person for whose use it is provided, with a safety belt or a restraint system fastened.

MEANS OF ILLUMINATION FOR LIFE-JACKETS

The means of electric illumination should be a survivor locator light as defined in the applicable ETSO issued by the Agency or equivalent.

RISK ASSESSMENT

- (a) When conducting the risk assessment, the pilot-in-command should base his/her decision, as far as is practicable, on the Implementing Rules and AMCs applicable to the operation of the aeroplane.
- (b) The pilot-in-command should, for determining the risk, take the following operating environment and conditions into account:
 - (1) sea state;
 - (2) sea and air temperatures;
 - (3) the distance from land suitable for making an emergency landing; and
 - (4) the availability of search and rescue facilities.

AMC2 SPO.IDE.A.195 Flight over water**LIFE RAFTS AND EQUIPMENT FOR MAKING DISTRESS SIGNALS**

- (a) The following should be readily available with each life-raft:
 - (1) means for maintaining buoyancy;
 - (2) a sea anchor;
 - (3) life-lines and means of attaching one life-raft to another;
 - (4) paddles for life-rafts with a capacity of six or less;
 - (5) means of protecting the occupants from the elements;
 - (6) a water-resistant torch;
 - (7) signalling equipment to make the pyrotechnic distress signals described in ICAO Annex 2, Rules of the Air;
 - (8) 100 g of glucose tablets for each four, or fraction of four, persons that the life-raft is designed to carry;
 - (9) at least 2 litres of drinkable water provided in durable containers or means of making sea water drinkable or a combination of both; and
 - (10) first-aid equipment.
- (b) As far as practicable, items listed in (a) should be contained in a pack.

GM1 SPO.IDE.A.195 Flight over water**SEAT CUSHIONS**

Seat cushions are not considered to be flotation devices.

SPO.IDE.A.200 Survival equipment

- (a) Aeroplanes operated over areas in which search and rescue would be especially difficult shall be equipped with:
- (1) signalling equipment to make the distress signals;
 - (2) at least one survival ELT (ELT(S)); and
 - (3) additional survival equipment for the route to be flown taking account of the number of persons on board.
- (b) The additional survival equipment specified in (a)(3) does not need to be carried when the aeroplane:
- (1) remains within a distance from an area where search and rescue is not especially difficult corresponding to:
 - (i) 120 minutes at one-engine-inoperative (OEI) cruising speed for aeroplanes capable of continuing the flight to an aerodrome with the critical engine(s) becoming inoperative at any point along the route or planned diversion routes; or
 - (ii) 30 minutes at cruising speed for all other aeroplanes; or
 - (2) remains within a distance no greater than that corresponding to 90 minutes at cruising speed from an area suitable for making an emergency landing, for aeroplanes certified in accordance with the applicable airworthiness standard.

AMC1 SPO.IDE.A.200 Survival equipment

ADDITIONAL SURVIVAL EQUIPMENT

- (a) The following additional survival equipment should be carried when required:
- (1) 500 ml of water for each four, or fraction of four, persons on board;
 - (2) one knife;
 - (3) first-aid equipment; and
 - (4) one set of air/ground codes.
- (b) In addition, when polar conditions are expected, the following should be carried:
- (1) a means of melting snow;
 - (2) one snow shovel and one ice saw;
 - (3) sleeping bags for use by 1/3 of all persons on board and space blankets for the remainder or space blankets for all persons on board; and
 - (4) one arctic/polar suit for each crew member
- (c) If any item of equipment contained in the above list is already carried on board the aircraft in accordance with another requirement, there is no need for this to be duplicated.

AMC1 SPO.IDE.A.200(a)(2) Survival equipment

SURVIVAL ELT

An ELT(AP) may be used to replace one required ELT(S) provided that it meets the ELT(S) requirements. A water-activated ELT(S) is not an ELT(AP).

AMC1 SPO.IDE.A.200(b)(2) Survival equipment

APPLICABLE AIRWORTHINESS STANDARD

The applicable airworthiness standard should be CS-25 or equivalent.

GM1 SPO.IDE.A.200 Survival equipment

SIGNALLING EQUIPMENT

The signalling equipment for making distress signals is described in ICAO Annex 2, Rules of the Air.

GM2 SPO.IDE.A.200 Survival equipment

AREAS IN WHICH SEARCH AND RESCUE WOULD BE ESPECIALLY DIFFICULT

The expression 'areas in which search and rescue would be especially difficult' should be interpreted, in this context, as meaning:

- (a) areas so designated by the authority responsible for managing search and rescue; or
- (b) areas that are largely uninhabited and where:
 - (1) the authority referred to in (a) not published any information to confirm whether search and rescue would be or would not be especially difficult; and
 - (2) the authority referred to in (a) does not, as a matter of policy, designate areas as being especially difficult for search and rescue.

SPO.IDE.A.205 Individual protective equipment

Each person on board shall wear individual protective equipment that is adequate for the type of operation being undertaken.

GM1 SPO.IDE.A.205 Individual protective equipment

TYPES OF INDIVIDUAL PROTECTIVE EQUIPMENT

Personal protective equipment should include, but is not limited to: flying suits, gloves, helmets, protective shoes, etc.

SPO.IDE.A.210 Headset

- (a) Aeroplanes shall be equipped with a headset with a boom microphone or equivalent for each flight crew member at their assigned station in the flight crew compartment.
- (b) Aeroplanes operated under IFR or at night shall be equipped with a transmit button on the manual pitch and roll control for each required flight crew member.

SPO.IDE.A.215 Radio communication equipment

- (a) Aeroplanes operated under IFR or at night, or when required by the applicable airspace requirements, shall be equipped with radio communication equipment that, under normal radio propagating conditions, shall be capable of:
 - (1) conducting two-way communication for aerodrome control purposes;
 - (2) receiving meteorological information at any time during flight;
 - (3) conducting two-way communication at any time during flight with those aeronautical stations and on those frequencies prescribed by the appropriate authority; and
 - (4) providing for communication on the aeronautical emergency frequency 121,5 MHz.
- (b) When more than one communication equipment unit is required, each shall be independent of the other or others to the extent that a failure in any one will not result in failure of any other.

AMC1 SPO.IDE.A.210 Headset

GENERAL

- (a) A headset consists of a communication device that includes two earphones to receive and a microphone to transmit audio signals to the aeroplane's communication system. To comply with the minimum performance requirements, the earphones and microphone should match the communication system's characteristics and the flight crew compartment environment. The headset should be adequately adjustable in order to fit the flight crew's head. Headset boom microphones should be of the noise cancelling type.
- (b) If the intention is to utilise noise cancelling earphones, the operator should ensure that the earphones do not attenuate any aural warnings or sounds necessary for alerting the flight crew on matters related to the safe operation of the aeroplane.

GM1 SPO.IDE.A.210 Headset

GENERAL

The term 'headset' includes any aviation helmet incorporating headphones and microphone worn by a flight crew member.

GM1 SPO.IDE.A.215 Radio communication equipment

APPLICABLE AIRSPACE REQUIREMENTS

For aeroplanes being operated under European air traffic control, the applicable airspace requirements include the Single European Sky legislation.

SPO.IDE.A.220 Navigation equipment

- (a) Aeroplanes shall be equipped with navigation equipment that will enable them to proceed in accordance with:
 - (1) the ATS flight plan, if applicable; and
 - (2) the applicable airspace requirements.
- (b) Aeroplanes shall have sufficient navigation equipment to ensure that, in the event of the failure of one item of equipment at any stage of the flight, the remaining equipment shall allow safe navigation in accordance with (a), or an appropriate contingency action to be completed safely.
- (c) Aeroplanes operated on flights in which it is intended to land in IMC shall be equipped with suitable equipment capable of providing guidance to a point from which a visual landing can be performed. This equipment shall be capable of providing such guidance for each aerodrome at which it is intended to land in IMC and for any designated alternate aerodromes.
- (d) For PBN operations the aircraft shall meet the airworthiness certification requirements for the appropriate navigation specification.

AMC1 SPO.IDE.A.220 Navigation equipment

NAVIGATION WITH VISUAL REFERENCE TO LANDMARKS — OTHER-THAN COMPLEX AEROPLANES

Where other-than complex aeroplanes, with the surface in sight, can proceed according to the ATS flight plan by navigation with visual reference to landmarks, no additional equipment is needed to comply with SPO.IDE.A.220 (a)(1).

GM1 SPO.IDE.A.220 Navigation equipment

AIRCRAFT ELIGIBILITY FOR PBN SPECIFICATION NOT REQUIRING SPECIFIC APPROVAL

- (a) The performance of the aircraft is usually stated in the AFM.
- (b) Where such a reference cannot be found in the AFM, other information provided by the aircraft manufacturer as TC holder, the STC holder or the design organisation having a privilege to approve minor changes may be considered.
- (c) The following documents are considered acceptable sources of information:
 - (1) AFM, supplements thereto, and documents directly referenced in the AFM;
 - (2) FCOM or similar document;
 - (3) Service Bulletin or Service Letter issued by the TC holder or STC holder;
 - (4) approved design data or data issued in support of a design change approval;
 - (5) any other formal document issued by the TC or STC holders stating compliance with PBN specifications, AMC, Advisory Circulars (AC) or similar documents issued by the State of Design; and
 - (6) written evidence obtained from the State of Design.
- (d) Equipment qualification data, in itself, is not sufficient to assess the PBN capabilities of the aircraft, since the latter depend on installation and integration.
- (e) As some PBN equipment and installations may have been certified prior to the publication of the PBN Manual and the adoption of its terminology for the navigation specifications, it is not always possible to find a clear statement of aircraft PBN capability in the AFM. However, aircraft

eligibility for certain PBN specifications can rely on the aircraft performance certified for PBN procedures and routes prior to the publication of the PBN Manual.

- (f) Below, various references are listed which may be found in the AFM or other acceptable documents (see listing above) in order to consider the aircraft's eligibility for a specific PBN specification if the specific term is not used.
- (g) RNAV 5
- (1) If a statement of compliance with any of the following specifications or standards is found in the acceptable documentation as listed above, the aircraft is eligible for RNAV 5 operations.
- (i) B-RNAV;
 - (ii) RNAV 1;
 - (iii) RNP APCH;
 - (iv) RNP 4;
 - (v) A-RNP;
 - (vi) AMC 20-4;
 - (vii) JAA TEMPORARY GUIDANCE MATERIAL, LEAFLET NO. 2 (TGL 2);
 - (viii) JAA AMJ 20X2;
 - (ix) FAA AC 20-130A for en route operations;
 - (x) FAA AC 20-138 for en route operations; and
 - (xi) FAA AC 90-96.
- (h) RNAV 1/RNAV 2
- (1) If a statement of compliance with any of the following specifications or standards is found in the acceptable documentation as listed above, the aircraft is eligible for RNAV 1/RNAV 2 operations.
- (i) RNAV 1;
 - (ii) PRNAV
 - (iii) US RNAV type A;
 - (iv) FAA AC 20-138 for the appropriate navigation specification;
 - (v) FAA AC 90-100A;
 - (vi) JAA TEMPORARY GUIDANCE MATERIAL, LEAFLET NO. 10 Rev1 (TGL 10); and
 - (vii) FAA AC 90-100.
- (2) However, if position determination is exclusively computed based on VOR-DME, the aircraft is not eligible for RNAV 1/RNAV 2 operations.
- (i) RNP 1/RNP 2 continental
- (1) If a statement of compliance with any of the following specifications or standards is found in the acceptable documentation as listed above, the aircraft is eligible for RNP 1/RNP 2 continental operations.
- (i) A-RNP;
 - (ii) FAA AC 20-138 for the appropriate navigation specification; and

- (iii) FAA AC 90-105.
- (2) Alternatively, if a statement of compliance with any of the following specifications or standards is found in the acceptable documentation as listed above and position determination is primarily based on GNSS, the aircraft is eligible for RNP 1/RNP 2 continental operations. However, in these cases, loss of GNSS implies loss of RNP 1/RNP 2 capability.
 - (i) JAA TEMPORARY GUIDANCE MATERIAL, LEAFLET NO. 10 (TGL 10) (any revision); and
 - (ii) FAA AC 90-100.
- (j) RNP APCH — LNAV minima
 - (1) If a statement of compliance with any of the following specifications or standards is found in the acceptable documentation as listed above, the aircraft is eligible for RNP APCH — LNAV operations.
 - (i) A-RNP;
 - (ii) AMC 20-27;
 - (iii) AMC 20-28;
 - (iv) FAA AC 20-138 for the appropriate navigation specification; and
 - (v) FAA AC 90-105 for the appropriate navigation specification.
 - (2) Alternatively, if a statement of compliance with RNP 0.3 GNSS approaches in accordance with any of the following specifications or standards is found in the acceptable documentation as listed above, the aircraft is eligible for RNP APCH — LNAV operations. Any limitation such as ‘within the US National Airspace’ may be ignored since RNP APCH procedures are assumed to meet the same ICAO criteria around the world.
 - (i) JAA TEMPORARY GUIDANCE MATERIAL, LEAFLET NO. 3 (TGL 3);
 - (ii) AMC 20-4;
 - (iii) FAA AC 20-130A; and
 - (iv) FAA AC 20-138.
- (k) RNP APCH — LNAV/VNAV minima
 - (1) If a statement of compliance with any of the following specifications or standards is found in the acceptable documentation as listed above, the aircraft is eligible for RNP APCH — LNAV/VNAV operations.
 - (i) A-RNP;
 - (ii) AMC 20-27 with Baro VNAV;
 - (iii) AMC 20-28;
 - (iv) FAA AC 20-138; and
 - (v) FAA AC 90-105 for the appropriate navigation specification.
 - (2) Alternatively, if a statement of compliance with FAA AC 20-129 is found in the acceptable documentation as listed above, and the aircraft complies with the requirements and limitations of EASA SIB 2014-04⁵, the aircraft is eligible for RNP APCH — LNAV/VNAV

⁵ <http://ad.easa.europa.eu/ad/2014-04>

operations. Any limitation such as ‘within the US National Airspace’ may be ignored since RNP APCH procedures are assumed to meet the same ICAO criteria around the world.

(l) RNP APCH — LPV minima

- (1) If a statement of compliance with any of the following specifications or standards is found in the acceptable documentation as listed above, the aircraft is eligible for RNP APCH — LPV operations.
 - (i) AMC 20-28;
 - (ii) FAA AC 20-138 for the appropriate navigation specification; and
 - (iii) FAA AC 90-107.
- (2) For aircraft that have a TAWS Class A installed and do not provide Mode-5 protection on an LPV approach, the DH is limited to 250 ft.

(m) RNAV 10

- (1) If a statement of compliance with any of the following specifications or standards is found in the acceptable documentation as listed above, the aircraft is eligible for RNAV 10 operations.
 - (i) RNP 10;
 - (ii) FAA AC 20-138 for the appropriate navigation specification;
 - (iii) AMC 20-12;
 - (iv) FAA Order 8400.12 (or later revision); and
 - (v) FAA AC 90-105.

(n) RNP 4

- (1) If a statement of compliance with any of the following specifications or standards is found in the acceptable documentation as listed above, the aircraft is eligible for RNP 4 operations.
 - (i) FAA AC 20-138B or later, for the appropriate navigation specification;
 - (ii) FAA Order 8400.33; and
 - (iii) FAA AC 90-105 for the appropriate navigation specification.

(o) RNP 2 oceanic

- (1) If a statement of compliance with FAA AC 90-105 for the appropriate navigation specification is found in the acceptable documentation as listed above, the aircraft is eligible for RNP 2 oceanic operations.
- (2) If the aircraft has been assessed eligible for RNP 4, the aircraft is eligible for RNP 2 oceanic.

(p) Special features

- (1) RF in terminal operations (used in RNP 1 and in the initial segment of the RNP APCH)
 - (i) If a statement of demonstrated capability to perform an RF leg, certified in accordance with any of the following specifications or standards, is found in the acceptable documentation as listed above, the aircraft is eligible for RF in terminal operations:
 - (A) AMC 20-26; and

- (B) FAA AC 20-138B or later.
- (ii) If there is a reference to RF and a reference to compliance with AC 90-105, then the aircraft is eligible for such operations.
- (q) Other considerations
 - (1) In all cases, the limitations in the AFM need to be checked, in particular the use of AP or FD which can be required to reduce the FTE primarily for RNP APCH, RNAV 1, and RNP 1.
 - (2) Any limitation such as ‘within the US National Airspace’ may be ignored since RNP APCH procedures are assumed to meet the same ICAO criteria around the world.

GM2 SPO.IDE.A.220 Navigation equipment

GENERAL

- (a) The PBN specifications for which the aircraft complies with the relevant airworthiness criteria are set out in the AFM, together with any limitations to be observed.
- (b) Because functional and performance requirements are defined for each navigation specification, an aircraft approved for an RNP specification is not automatically approved for all RNAV specifications. Similarly, an aircraft approved for an RNP or RNAV specification having a stringent accuracy requirement (e.g. RNP 0.3 specification) is not automatically approved for a navigation specification having a less stringent accuracy requirement (e.g. RNP 4).

RNP 4

- (c) For RNP 4, at least two LRNSs, capable of navigating to RNP 4, and listed in the AFM, may be operational at the entry point of the RNP 4 airspace. If an item of equipment required for RNP 4 operations is unserviceable, then the flight crew may consider an alternate route or diversion for repairs. For multi-sensor systems, the AFM may permit entry if one GNSS sensor is lost after departure, provided one GNSS and one inertial sensor remain available.

SPO.IDE.A.225 Transponder

Where required by the airspace being flown, aeroplanes shall be equipped with a secondary surveillance radar (SSR) transponder with all the required capabilities.

AMC1 SPO.IDE.A.225 Transponder

GENERAL

- (a) The secondary surveillance radar (SSR) transponders of aeroplanes being operated under European air traffic control should comply with any applicable Single European Sky legislation.
- (b) If the Single European Sky legislation is not applicable, the SSR transponders should operate in accordance with the relevant provisions of Volume IV of ICAO Annex 10.

SPO.IDE.A.230 Management of aeronautical databases

Applicable
from 01
January
2019

- (a) Aeronautical databases used on certified aircraft system applications shall meet data quality requirements that are adequate for the intended use of the data.
- (b) The operator shall ensure the timely distribution and insertion of current and unaltered aeronautical databases to all aircraft that require them.
- (c) Notwithstanding any other occurrence reporting requirements as defined in Regulation (EU) No 376/2014, the operator shall report to the database provider instances of erroneous, inconsistent or missing data that might be reasonably expected to constitute a hazard to flight.

In such cases, the operator shall inform flight crew and other personnel concerned, and shall ensure that the affected data is not used.

SECTION 2
Helicopters**SPO.IDE.H.100 Instruments and equipment — general**

- (a) Instruments and equipment required by this Subpart shall be approved in accordance with the applicable airworthiness requirements if they are:
- (1) used by the flight crew to control the flight path;
 - (2) used to comply with SPO.IDE.H.215;
 - (3) used to comply with SPO.IDE.H.220; or
 - (4) installed in the helicopter.
- (b) The following items, when required by this Subpart, do not need an equipment approval:
- (1) independent portable light,
 - (2) an accurate time piece,
 - (3) chart holder,
 - (4) first-aid kit,
 - (5) survival and signalling equipment, and
 - (6) sea anchor and equipment for mooring.
- (c) Instruments and equipment not required by this Subpart as well as any other equipment that is not required by other applicable Annexes, but is carried on a flight, shall comply with the following:
- (1) the information provided by these instruments, equipment or accessories shall not be used by the flight crew to comply with Annex I to Regulation (EC) No 216/2008 or SPO.IDE.H.215 and SPO.IDE.H.220; and
 - (2) the instruments and equipment shall not affect the airworthiness of the helicopter, even in the case of failures or malfunction.
- (d) Instruments and equipment shall be readily operable or accessible from the station where the flight crew member that needs to use it is seated.
- (e) Those instruments that are used by a flight crew member shall be so arranged as to permit the flight crew member to see the indications readily from his/her station, with the minimum practicable deviation from the position and line of vision which he/she normally assumes when looking forward along the flight path.
- (f) All required emergency equipment shall be easily accessible for immediate use.

GM1 SPO.IDE.H.100(a) Instruments and equipment — general**APPLICABLE AIRWORTHINESS REQUIREMENTS**

The applicable airworthiness requirements for approval of instruments and equipment required by this Part are the following:

- (a) Commission Regulation (EU) No 748/2012 for helicopters registered in the EU; and

- (b) Airworthiness requirements of the state of registry for helicopters registered outside the EU.

GM1 SPO.IDE.H.100(b) Instruments and equipment — general

REQUIRED INSTRUMENTS AND EQUIPMENT THAT DO NOT NEED TO BE APPROVED IN ACCORDANCE WITH THE APPLICABLE AIRWORTHINESS REQUIREMENTS

The functionality of non-installed instruments and equipment required by this Subpart and that do not need an equipment approval, as listed in SPO.IDE.H.100(b), should be checked against recognised industry standards appropriate to the intended purpose. The operator is responsible for ensuring the maintenance of these instruments and equipment.

GM1 SPO.IDE.H.100(c) Instruments and equipment — general

NOT REQUIRED INSTRUMENTS AND EQUIPMENT THAT DO NOT NEED TO BE APPROVED IN ACCORDANCE WITH THE APPLICABLE AIRWORTHINESS REQUIREMENTS, BUT ARE CARRIED ON A FLIGHT

- (a) The provision of this paragraph does not exempt any installed instrument or item of equipment from complying with the applicable airworthiness requirements. In this case, the installation should be approved as required in the applicable airworthiness requirements and should comply with the applicable Certification Specifications.
- (b) The failure of additional non-installed instruments or equipment not required by this Part or by the applicable airworthiness requirements or any applicable airspace requirements should not adversely affect the airworthiness and/or the safe operation of the helicopter. Examples may be the following:
- (1) portable electronic flight bag (EFB);
 - (2) portable electronic devices carried by crew members or task specialists; and
 - (3) non-installed task specialists equipment.

GM1 SPO.IDE.H.100 (d) Instruments and equipment — general

POSITIONING OF INSTRUMENTS

This requirement implies that whenever a single instrument is required in a helicopter operated in a multi-crew environment, the instrument needs to be visible from each flight crew station.

SPO.IDE.H.105 Minimum equipment for flight

A flight shall not be commenced when any of the helicopter's instruments, items of equipment or functions required for the intended flight are inoperative or missing, unless:

- (a) the helicopter is operated in accordance with the minimum equipment list (MEL), if established;
- (b) for complex motor-powered helicopters, and for any helicopter used in commercial operations, the operator is approved by the competent authority to operate the helicopter within the constraints of the master minimum equipment list (MMEL); or
- (c) the helicopter is subject to a permit to fly issued in accordance with the applicable airworthiness requirements.

SPO.IDE.H.115 Operating lights

Helicopters operated at night shall be equipped with:

- (a) an anti-collision light system;
- (b) navigation/position lights;
- (c) a landing light;
- (d) lighting supplied from the helicopter's electrical system to provide adequate illumination for all instruments and equipment essential to the safe operation of the helicopter;
- (e) lighting supplied from the helicopter's electrical system to provide illumination in all cabin compartments;
- (f) an independent portable light for each crew member station; and
- (g) lights to conform with the International Regulations for Preventing Collisions at Sea if the helicopter is amphibious.

AMC1 SPO.IDE.H.115 Operating lights**LANDING LIGHT**

The landing light should be trainable, at least in the vertical plane, or optionally be an additional fixed light or lights positioned to give a wide spread of illumination.

SPO.IDE.H.120 Operations under VFR — flight and navigational instruments and associated equipment

- (a) Helicopters operated under VFR by day shall be equipped with a means of measuring and displaying the following:
- (1) magnetic heading,
 - (2) time in hours, minutes and seconds,
 - (3) pressure altitude,
 - (4) indicated airspeed, and
 - (5) slip.
- (b) Helicopters operated under VMC overwater and out of sight of the land or under VMC at night, shall be, in addition to (a), equipped with:
- (1) a means of measuring and displaying:
 - (i) attitude,
 - (ii) vertical speed, and
 - (iii) stabilised heading;
 - (2) a means of indicating when the supply of power to the gyroscopic instruments is not adequate; and
 - (3) for complex motor-powered helicopters, a means of preventing malfunction of the airspeed indicating system required in (a)(4) due to condensation or icing.
- (c) Helicopters operated when the visibility is less than 1500 m, or in conditions where they cannot be maintained in a desired flight path without reference to one or more additional instruments, shall be, in addition to (a) and (b), equipped with a means of preventing malfunction of the airspeed indicating system required in (a)(4) due to condensation or icing.
- (d) Whenever two pilots are required for the operation, helicopters shall be equipped with an additional separate means of displaying:
- (1) pressure altitude,
 - (2) indicated airspeed,
 - (3) slip,
 - (4) attitude, if applicable,
 - (5) vertical speed, if applicable, and
 - (6) stabilised heading, if applicable.

AMC1 SPO.IDE.H.120 & SPO.IDE.H.125 Operations under VFR & operations under IFR — flight and navigational instruments and associated equipment**INTEGRATED INSTRUMENTS**

- (a) Individual equipment requirements may be met by combinations of instruments, by integrated flight systems or by a combination of parameters on electronic displays. The information so available to each required pilot should not be less than that required in the applicable operational requirements, and the equivalent safety of the installation should be approved during type certification of the helicopter for the intended type of operation.

- (b) The means of measuring and indicating turn and slip, helicopter attitude and stabilised helicopter heading may be met by combinations of instruments or by integrated flight director systems, provided that the safeguards against total failure, inherent in the three separate instruments, are retained.

AMC1 SPO.IDE.H.120(a)(1) & SPO.IDE.H.125(a)(1) Operations under VFR & operations under IFR — flight and navigational instruments and associated equipment

MEANS OF MEASURING AND DISPLAYING MAGNETIC HEADING

The means of measuring and displaying magnetic direction should be a magnetic compass or equivalent.

AMC1 SPO.IDE.H.120(a)(2) & SPO.IDE.H.125(a)(2) Operations under VFR & operations under IFR — flight and navigational instruments and associated equipment

MEANS OF MEASURING AND DISPLAYING THE TIME — COMPLEX MOTOR-POWERED AIRCRAFT

An acceptable means of compliance is a clock displaying hours, minutes and seconds, with a sweep-second pointer or digital presentation.

MEANS OF MEASURING AND DISPLAYING THE TIME — OTHER-THAN- COMPLEX MOTOR-POWERED AIRCRAFT

An acceptable means of measuring and displaying the time in hours, minutes and seconds may be a wrist watch capable of the same functions.

AMC1 SPO.IDE.H.120(a)(3) & SPO.IDE.H.125(a)(3) Operations under VFR & operations under IFR — flight and navigational instruments and associated equipment

CALIBRATION OF THE MEANS OF MEASURING AND DISPLAYING PRESSURE ALTITUDE

The instrument measuring and displaying pressure altitude should be of a sensitive type calibrated in feet (ft), with a sub-scale setting, calibrated in hectopascals/millibars, adjustable for any barometric pressure likely to be set during flight.

AMC1 SPO.IDE.H.120(a)(4) & SPO.IDE.H.125(a)(4) Operations under VFR & operations under IFR — flight and navigational instruments and associated equipment

CALIBRATION OF THE INSTRUMENT INDICATING AIRSPEED

- (a) The instrument indicating airspeed should be calibrated in knots (kt).
- (b) In the case of helicopters with an MCTOM below 2 000 kg, calibration in kilometres per hour (kph) or in miles per hour (mph) is acceptable when such units are used in the AFM.

AMC1 SPO.IDE.H.120(a)(5) Operations under VFR — flight and navigational instruments and associated equipment

SLIP

For other-than complex helicopters the means of measuring and displaying slip may be a slip string for operations under VFR.

AMC1 SPO.IDE.H.120(d) & SPO.IDE.H.125(c) Operations under VFR & operations under IFR — flight and navigational instruments and associated equipment**MULTI-PILOT OPERATIONS — DUPLICATE INSTRUMENTS**

Duplicate instruments include separate displays for each pilot and separate selectors or other associated equipment where appropriate.

AMC1 SPO.IDE.H.120(b)(1)(iii) & SPO.IDE.H.125(a)(8) Operations under VFR & operations under IFR — flight and navigational instruments and associated equipment**STABILISED HEADING**

Stabilised direction should be achieved for VFR flights by a gyroscopic direction indicator, whereas for IFR flights, this should be achieved through a magnetic gyroscopic direction indicator.

AMC1 SPO.IDE.H.120(b)(3) & SPO.IDE.H.125(d) Operations under VFR & operations under IFR — flight and navigational instruments and associated equipment**MEANS OF PREVENTING MALFUNCTION DUE TO CONDENSATION OR ICING**

The means of preventing malfunction due to either condensation or icing of the airspeed indicating system should be a heated pitot tube or equivalent.

SPO.IDE.H.125 Operations under IFR — flight and navigational instruments and associated equipment

Helicopters operated under IFR shall be equipped with:

- (a) a means of measuring and displaying:
 - (1) magnetic heading,
 - (2) time in hours, minutes and seconds,
 - (3) pressure altitude,
 - (4) indicated airspeed,
 - (5) vertical speed,
 - (6) slip,
 - (7) attitude,
 - (8) stabilised heading, and
 - (9) outside air temperature;
- (b) a means of indicating when the supply of power to the gyroscopic instruments is not adequate;
- (c) whenever two pilots are required for the operation, an additional separate means of displaying:
 - (1) pressure altitude,
 - (2) indicated airspeed,
 - (3) vertical speed,
 - (4) slip,
 - (5) attitude, and
 - (6) stabilised heading;
- (d) a means of preventing malfunction of the airspeed indicating system required by (a)(4) and (c)(2) due to condensation or icing;
- (e) an additional means of measuring and displaying attitude as a standby instrument; and
- (f) the following for complex motor-powered helicopters:
 - (1) an alternate source of static pressure; and
 - (2) a chart holder in an easily readable position that can be illuminated for night operations.

GM1 SPO.IDE.H.125(a)(3) Operations under IFR — flight and navigational instruments and associated equipment**ALTIMETERS**

Altimeters with counter drum-pointer or equivalent presentation are considered to be less susceptible to misinterpretation for helicopters operating above 10 000 ft.

AMC1 SPO.IDE.H.125(a)(9) Operations under IFR — flight and navigational instruments and associated equipment

MEANS OF DISPLAYING OUTSIDE AIR TEMPERATURE

- (a) The means of displaying outside air temperature should be calibrated in degrees Celsius.
- (b) In the case of helicopters with a maximum certified take-off mass (MCTOM) below 2 000 kg, calibration in degrees Fahrenheit is acceptable, when such unit is used in the AFM.
- (c) The means of displaying outside air temperature may be an air temperature indicator that provides indications that are convertible to outside air temperature.

AMC1 SPO.IDE.H.125(f)(2) Operations under IFR — flight and navigational instruments and associated equipment

CHART HOLDER

An acceptable means of compliance with the chart holder requirement would be to display a pre-composed chart on an electronic flight bag (EFB).

SPO.IDE.H.126 Additional equipment for single-pilot operation under IFR

Helicopters operated under IFR with a single pilot shall be equipped with an autopilot with at least altitude hold and heading mode.

SPO.IDE.H.132 Airborne weather detecting equipment — complex motor-powered helicopters

Helicopters operated under IFR or at night shall be equipped with airborne weather detecting equipment when current weather reports indicate that thunderstorms or other potentially hazardous weather conditions, regarded as detectable with airborne weather detecting equipment, may be expected to exist along the route to be flown.

AMC1 SPO.IDE.H.132 Airborne weather detecting equipment — complex motor-powered helicopters**GENERAL**

The airborne weather detecting equipment should be an airborne weather radar.

SPO.IDE.H.133 Additional equipment for operations in icing conditions at night — complex motor-powered helicopters

- (a) Helicopters operated in expected or actual icing conditions at night shall be equipped with a means to illuminate or detect the formation of ice.
- (b) The means to illuminate the formation of ice shall not cause glare or reflection that would handicap flight crew members in the performance of their duties.

SPO.IDE.H.135 Flight crew interphone system

Helicopters operated by more than one flight crew member shall be equipped with a flight crew interphone system, including headsets and microphones for use by all flight crew members.

AMC1 SPO.IDE.H.135 Flight crew interphone system

TYPE OF FLIGHT CREW INTERPHONE

The flight crew interphone system should not be of a handheld type.

SPO.IDE.H.140 Cockpit voice recorder

- (a) Helicopters with an MCTOM of more than 7 000 kg and first issued with an individual CofA on or after 1 January 2016 shall be equipped with a CVR.
- (b) The CVR shall be capable of retaining data recorded during at least the preceding 2 hours.
- (c) The CVR shall record with reference to a timescale:
 - (1) voice communications transmitted from or received in the flight crew compartment by radio;
 - (2) flight crew members' voice communications using the interphone system and the public address system, if installed;
 - (3) the aural environment of the cockpit, including, without interruption, the audio signals received from each crew microphone; and
 - (4) voice or audio signals identifying navigation or approach aids introduced into a headset or speaker.
- (d) The CVR shall start automatically to record prior to the helicopter moving under its own power and shall continue to record until the termination of the flight when the helicopter is no longer capable of moving under its own power.
- (e) In addition to (d), depending on the availability of electrical power, the CVR shall start to record as early as possible during the cockpit checks prior to engine start at the beginning of the flight until the cockpit checks immediately following engine shutdown at the end of the flight.
- (f) If the CVR is not deployable, it shall have a device to assist in locating it under water. By 1 January 2020 at the latest, this device shall have a minimum underwater transmission time of 90 days. If the CVR is deployable, it shall have an automatic emergency locator transmitter.

AMC1 SPO.IDE.H.140 Cockpit voice recorder

GENERAL

- (a) The operational performance requirements for cockpit voice recorders (CVRs) should be those laid down in EUROCAE Document ED-112 (Minimum Operational Performance Specification for Crash Protected Airborne Recorder Systems March 2003, including Amendments No°1 and 2, or any later equivalent standard produced by EUROCAE.
- (b) The operational performance requirements for equipment dedicated to the CVR should be those laid down in the European Organisation for Civil Aviation Equipment (EUROCAE) Document ED-56A (Minimum Operational Performance Requirements For Cockpit Voice Recorder Systems) dated December 1993, or EUROCAE Document ED-112 (Minimum Operational Performance Specification for Crash Protected Airborne Recorder Systems) dated March 2003, including Amendments n°1 and n°2, or any later equivalent standard produced by EUROCAE.

SPO.IDE.H.145 Flight data recorder

- (a) Helicopters with an MCTOM of more than 3 175 kg and first issued with an individual CofA on or after 1 January 2016 shall be equipped with an FDR that uses a digital method of recording and storing data and for which a method of readily retrieving that data from the storage medium is available.
- (b) The FDR shall record the parameters required to determine accurately the helicopter flight path, speed, attitude, engine power, configuration and operation and be capable of retaining data recorded during at least the preceding 10 hours.
- (c) Data shall be obtained from helicopter sources that enable accurate correlation with information displayed to the flight crew.
- (d) The FDR shall start automatically to record the data prior to the helicopter being capable of moving under its own power and shall stop automatically after the helicopter is incapable of moving under its own power.
- (e) If the FDR is not deployable, it shall have a device to assist in locating it under water. By 1 January 2020 at the latest, this device shall have a minimum underwater transmission time of 90 days. If the FDR is deployable, it shall have an automatic emergency locator transmitter.

AMC1 SPO.IDE.H.145 Flight data recorder

OPERATIONAL PERFORMANCE REQUIREMENTS FOR HELICOPTERS HAVING AN MCTOM OF MORE THAN 3 175 KG AND FIRST ISSUED WITH AN INDIVIDUAL CofA ON OR AFTER 1 JANUARY 2016 AND BEFORE 1 JANUARY 2023

- (a) The operational performance requirements for flight data recorders (FDRs) should be those laid down in EUROCAE Document ED-112 (Minimum Operational Performance Specification for Crash Protected Airborne Recorder Systems) dated March 2003, including amendments No°1 and No°2, or any later equivalent standard produced by EUROCAE.
- (b) The FDR should record, with reference to a timescale, the list of parameters in Table 1 and Table 2, as applicable.
- (c) The parameters recorded by the FDR should meet, as far as practicable, the performance specifications (designated ranges, sampling intervals, accuracy limits and minimum resolution in read-out) defined in EUROCAE ED-112, including amendments No°1 and No°2, or any later equivalent standard produced by EUROCAE.
- (d) FDR systems for which some recorded parameters do not meet the performance specifications of EUROCAE Document ED-112 may be acceptable to the Agency.

Table 1: FDR parameters — All helicopters

No*	Parameter
1	Time or relative time count
2	Pressure altitude
3	Indicated airspeed
4	Heading

No*	Parameter
5	Normal acceleration
6	Pitch attitude
7	Roll attitude
8	Manual radio transmission keying CVR/FDR synchronisation reference
9	Power on each engine:
9a	Free power turbine speed (N_F)
9b	Engine torque
9c	Engine gas generator speed (N_G)
9d	Flight crew compartment power control position
9e	Other parameters to enable engine power to be determined
10	Rotor:
10a	Main rotor speed
10b	Rotor brake (if installed)
11	Primary flight controls — Pilot input and/or control output position (if applicable)
11a	Collective pitch
11b	Longitudinal cyclic pitch
11c	Lateral cyclic pitch
11d	Tail rotor pedal
11e	Controllable stabilator (if applicable)
11f	Hydraulic selection
12	Hydraulics low pressure (each system should be recorded.)
13	Outside air temperature
18	Yaw rate or yaw acceleration
20	Longitudinal acceleration (body axis)
21	Lateral acceleration
25	Marker beacon passage
26	Warnings — a discrete should be recorded for the master warning, gearbox low oil pressure and as failure. Other 'red' warnings should be recorded where the warning condition cannot be determined from other parameters or from the cockpit voice recorder.

No*	Parameter
27	Each navigation receiver frequency selection
37	Engine control modes

* The number in the left hand column reflects the serial number depicted in EUROCAE ED-112.

Table 2: FDR parameters — Helicopters for which the data source for the parameter is either used by helicopter systems or is available on the instrument panel for use by the flight crew to operate the helicopter.

No*	Parameter
14	AFCS mode and engagement status
15	Stability augmentation system engagement (each system should be recorded)
16	Main gear box oil pressure
17	Gear box oil temperature
17a	Main gear box oil temperature
17b	Intermediate gear box oil temperature
17c	Tail rotor gear box oil temperature
19	Indicated sling load force (if signals readily available)
22	Radio altitude
23	Vertical deviation — the approach aid in use should be recorded.
23a	ILS glide path
23b	MLS elevation
23c	GNSS approach path
24	Horizontal deviation — the approach aid in use should be recorded.
24a	ILS localiser
24b	MLS azimuth
24c	GNSS approach path
28	DME 1 & 2 distances
29	Navigation data
29a	Drift angle
29b	Wind speed
29c	Wind direction

No*	Parameter
29d	Latitude
29e	Longitude
29f	Ground speed
30	Landing gear or gear selector position
31	Engine exhaust gas temperature (T ₄)
32	Turbine inlet temperature (TIT/ITT)
33	Fuel contents
34	Altitude rate (vertical speed) — only necessary when available from cockpit instruments
35	Ice detection
36	Helicopter health and usage monitor system (HUMS)
36a	Engine data
36b	Chip detector
36c	Track timing
36d	Exceedance discretets
36e	Broadband average engine vibration
38	Selected barometric setting — to be recorded for helicopters where the parameter is displayed electronically
38a	Pilot
38b	Co-pilot
39	Selected altitude (all pilot selectable modes of operation) — to be recorded for the helicopters where the parameter is displayed electronically
40	Selected speed (all pilot selectable modes of operation) — to be recorded for the helicopters where the parameter is displayed electronically
41	Not used (selected Mach)
42	Selected vertical speed (all pilot selectable modes of operation) — to be recorded for the helicopters where the parameter is displayed electronically
43	Selected heading (all pilot selectable modes of operation) — to be recorded for the helicopters where the parameter is displayed electronically
44	Selected flight path (all pilot selectable modes of operation) — to be recorded for the helicopters where the parameter is displayed electronically

No*	Parameter
45	Selected decision height (all pilot selectable modes of operation) — to be recorded for the helicopters where the parameter is displayed electronically
46	EFIS display format
47	Multi-function/engine/alerts display format
48	Event marker

* The number in the left hand column reflects the serial number depicted in EUROCAE ED-112.

AMC2 SPO.IDE.H.145 Flight data recorder

OPERATIONAL PERFORMANCE REQUIREMENTS FOR HELICOPTERS HAVING AN MCTOM OF MORE THAN 3 175 KG AND FIRST ISSUED WITH AN INDIVIDUAL CofA ON OR AFTER 1 JANUARY 2023

- (a) The operational performance requirements for flight data recorders (FDRs) should be those laid down in EUROCAE Document 112A (Minimum Operational Performance Specification for Crash Protected Airborne Recorder Systems) dated September 2013, or any later equivalent standard produced by EUROCAE.
- (b) The FDR should, with reference to a timescale, record:
- (1) the list of parameters in Table 1 below;
 - (2) the additional parameters listed in Table 2 below, when the information data source for the parameter is used by helicopter systems or is available on the instrument panel for use by the flight crew to operate the helicopter; and
 - (3) any dedicated parameters related to novel or unique design or operational characteristics of the helicopter as determined by the Agency.
- (c) The parameters to be recorded should meet the performance specifications (range, sampling intervals, accuracy limits and resolution in read-out) as defined in the relevant tables of EUROCAE Document 112A, or any later equivalent standard produced by EUROCAE.

Table 1: FDR — All helicopters

No*	Parameter
1	Time or relative time count
2	Pressure altitude
3	Indicated airspeed or calibrated airspeed
4	Heading
5	Normal acceleration
6	Pitch attitude

No*	Parameter
7	Roll attitude
8	Manual radio transmission keying CVR/FDR synchronisation reference
9	Power on each engine:
9a	Free power turbine speed (N_F)
9b	Engine torque
9c	Engine gas generator speed (N_G)
9d	Flight crew compartment power control position
9e	Other parameters to enable engine power to be determined
10	Rotor:
10a	Main rotor speed
10b	Rotor brake (if installed)
11	Primary flight controls — pilot input or control output position if it is possible to derive either the control input or the control movement (one from the other) for all modes of operation and flight regimes. Otherwise, pilot input and control output position
11a	Collective pitch
11b	Longitudinal cyclic pitch
11c	Lateral cyclic pitch
11d	Tail rotor pedal
11e	Controllable stabilator (if applicable)
11f	Hydraulic selection
12	Hydraulics low pressure (each system should be recorded)
13	Outside air temperature
18	Yaw rate or yaw acceleration
20	Longitudinal acceleration (body axis)
21	Lateral acceleration
25	Marker beacon passage
26	Warnings — including master warning, gearbox low oil pressure and stability augmentation system failure, and other 'red' warnings where the warning condition cannot be determined from other parameters or from the cockpit voice recorder.
27	Each navigation receiver frequency selection

No*	Parameter
37	Engine control modes

* The number in the left-hand column reflects the serial numbers depicted in EUROCAE Document 112A.

Table 2: Helicopters for which the data source for the parameter is either used by the helicopter systems or is available on the instrument panel for use by the flight crew to operate the helicopter

No*	Parameter
14	AFCS mode and engagement status (showing which systems are engaged and which primary modes are controlling the flight path)
15	Stability augmentation system engagement (each system should be recorded)
16	Main gear box oil pressure
17	Gear box oil temperature:
17a	Main gear box oil temperature
17b	Intermediate gear box oil temperature
17c	Tail rotor gear box oil temperature
19	Indicated sling load force (if signals readily available)
22	Radio altitude
23	Vertical deviation — the approach aid in use should be recorded:
23a	ILS glide path
23b	MLS elevation
23c	GNSS approach path
24	Horizontal deviation — the approach aid in use should be recorded:
24a	ILS localiser
24b	MLS azimuth
24c	GNSS approach path
28	DME 1 & 2 distances
29	Navigation data:
29a	Drift angle
29b	Wind speed
29c	Wind direction

No*	Parameter
29d	Latitude
29e	Longitude
29f	Ground speed
30	Landing gear or gear selector position
31	Engine exhaust gas temperature (T ₄)
32	Turbine inlet temperature (TIT)/interstage turbine temperature (ITT)
33	Fuel contents
34	Altitude rate (vertical speed) — only necessary when available from cockpit instruments
35	Ice detection
36	Helicopter health and usage monitor system (HUMS):
36a	Engine data
36b	Chip detector
36c	Track timing
36d	Exceedance discretets
36e	Broadband average engine vibration
38	Selected barometric setting — to be recorded for helicopters where the parameter is displayed electronically:
38a	Pilot
38b	Co-pilot
39	Selected altitude (all pilot selectable modes of operation) — to be recorded for the helicopters where the parameter is displayed electronically.
40	Selected speed (all pilot selectable modes of operation) — to be recorded for the helicopters where the parameter is displayed electronically.
41	Selected Mach (all pilot selectable modes of operation) — to be recorded for the helicopters where the parameter is displayed electronically.
42	Selected vertical speed (all pilot selectable modes of operation) — to be recorded for the helicopters where the parameter is displayed electronically.
43	Selected heading (all pilot selectable modes of operation) — to be recorded for the helicopters where the parameter is displayed electronically.
44	Selected flight path (all pilot selectable modes of operation) — to be recorded for the helicopters where the parameter is displayed electronically.

No*	Parameter
45	Selected decision height (all pilot selectable modes of operation) — to be recorded for the helicopters where the parameter is displayed electronically.
46	EFIS display format (showing the display system status):
46a	Pilot
46b	First officer
47	Multi-function/engine/alerts display format (showing the display system status)
48	Event marker
49	Status of ground proximity warning system (GPWS)/terrain awareness warning system (TAWS)/ground collision avoidance system (GCAS):
49a	Selection of terrain display mode including pop-up display status — for helicopters type certified before 1 January 2023, to be recorded only if this does not require extensive modification.
49b	Terrain alerts, both cautions and warnings, and advisories — for helicopters type certified before 1 January 2023, to be recorded only if this does not require extensive modification.
49c	On/off switch position — for helicopters type certified before 1 January 2023, to be recorded only if this does not require extensive modification.
50	Traffic alert and collision avoidance system (TCAS)/airborne collision avoidance system (ACAS):
50a	Combined control — for helicopters type certified before 1 January 2023, to be recorded only if this does not require extensive modification.
50b	Vertical control — for helicopters type certified before 1 January 2023, to be recorded only if this does not require extensive modification.
50c	Up advisory — for helicopters type certified before 1 January 2023, to be recorded only if this does not require extensive modification.
50d	Down advisory — for helicopters type certified before 1 January 2023, to be recorded only if this does not require extensive modification.
50e	Sensitivity level — for helicopters type certified before 1 January 2023, to be recorded only if this does not require extensive modification.

No*	Parameter
51	Primary flight controls — pilot input forces:
51a	Collective pitch — for helicopters type certified before 1 January 2023, to be recorded only if this does not require extensive modification.
51b	Longitudinal cyclic pitch — for helicopters type certified before 1 January 2023, to be recorded only if this does not require extensive modification.
51c	Lateral cyclic pitch — for helicopters type certified before 1 January 2023, to be recorded only if this does not require extensive modification.
51d	Tail rotor pedal – for helicopters type certified before 1 January 2023, to be recorded only if this does not require extensive modification.
52	Computed centre of gravity — for helicopters type certified before 1 January 2023, to be recorded only if this does not require extensive modification.
53	Helicopter computed weight — for helicopters type certified before 1 January 2023, to be recorded only if this does not require extensive modification.

* The number in the left-hand column reflects the serial numbers depicted in EUROCAE Document 112A.

SPO.IDE.H.150 Data link recording

- (a) Helicopters first issued with an individual CofA on or after 1 January 2016 that have the capability to operate data link communications and are required to be equipped with a CVR shall record on a recorder, where applicable:
- (1) data link communication messages related to ATS communications to and from the helicopter, including messages applying to the following applications:
 - (i) data link initiation;
 - (ii) controller-pilot communication;
 - (iii) addressed surveillance;
 - (iv) flight information;
 - (v) as far as is practicable, given the architecture of the system, aircraft broadcast surveillance;
 - (vi) as far as is practicable, given the architecture of the system, aircraft operational control data; and
 - (vii) as far as is practicable, given the architecture of the system, graphics;
 - (2) information that enables correlation to any associated records related to data link communications and stored separately from the helicopter; and
 - (3) information on the time and priority of data link communications messages, taking into account the system's architecture.
- (b) The recorder shall use a digital method of recording and storing data and information and a method for readily retrieving that data. The recording method shall allow the data to match the data recorded on the ground.
- (c) The recorder shall be capable of retaining data recorded for at least the same duration as set out for CVRs in SPO.IDE.H.140.
- (d) If the recorder is not deployable, it shall have a device to assist in locating it under water. By 1 January 2020 at the latest, this device shall have a minimum underwater transmission time of 90 days. If the recorder is deployable, it shall have an automatic emergency locator transmitter.
- (e) The requirements applicable to the start and stop logic of the recorder are the same as the requirements applicable to the start and stop logic of the CVR contained in SPO.IDE.H.140 (d) and (e).

AMC1 SPO.IDE.H.150 Data link recording

GENERAL

- (a) As a means of compliance with SPO.IDE.H.150, the recorder on which the data link messages are recorded should be:
- (1) the CVR;
 - (2) the FDR;
 - (3) a combination recorder when SPO.IDE.H.155 is applicable; or
 - (4) a dedicated flight recorder. In such case, the operational performance requirements for this recorder should be those laid down in EUROCAE Document ED-112 (Minimum Operational Performance Specification for Crash Protected Airborne Recorder Systems),

dated March 2003, including amendments No°1 and No°2, or any later equivalent standard produced by EUROCAE.

- (b) As a means of compliance with SPO.IDE.H.150 (a)(2), the operator should enable correlation by providing information that allows an accident investigator to understand what data was provided to the aircraft and, when the provider identification is contained in the message, by which provider.
- (c) The timing information associated with the data link communications messages required to be recorded by SPO.IDE.H.150(a)(3) should be capable of being determined from the airborne-based recordings. This timing information should include at least the following:
- (1) the time each message was generated;
 - (2) the time any message was available to be displayed by the flight crew;
 - (3) the time each message was actually displayed or recalled from a queue; and
 - (4) the time of each status change.
- (d) The message priority should be recorded when it is defined by the protocol of the data link communication message being recorded.
- (e) The expression ‘taking into account the system’s architecture’, in SPO.IDE.H.150 (a)(3), means that the recording of the specified information may be omitted if the existing source systems involved would require a major upgrade. The following should be considered:
- (1) the extent of the modification required;
 - (2) the down-time period; and
 - (3) equipment software development.
- (f) Data link communications messages that support the applications in Table 1 should be recorded.
- (g) Further details on the recording requirements can be found in the recording requirement matrix in Appendix D.2 of EUROCAE Document ED-93 (Minimum Aviation System Performance Specification for CNS/ATM Recorder Systems), dated November 1998.

Table 1: Data link recording

Item No	Application Type	Application Description	Required Recording Content
1	Data link initiation	This includes any application used to log on to, or initiate, a data link service. In future air navigation system (FANS)-1/A and air traffic navigation (ATN), these are ATS facilities notification (AFN) and context management (CM), respectively.	C
2	Controller/pilot communication	This includes any application used to exchange requests, clearances, instructions and reports between the flight crew and controllers on the ground. In FANS-1/A and ATN, this includes the controller pilot data link communications (CPDLC) application.	C

Item No	Application Type	Application Description	Required Recording Content
		It also includes applications used for the exchange of oceanic clearances (OCL) and departure clearances (DCL), as well as data link delivery of taxi clearances.	
3	Addressed surveillance	This includes any surveillance application in which the ground sets up contracts for delivery of surveillance data. In FANS-1/A and ATN, this includes the automatic dependent surveillance-contract (ADS-C) application.	C, F2
4	Flight information	This includes any application used for delivery of flight information data to specific aeroplanes. This includes for example data link-automatic terminal information service (D-ATIS), data link-operational terminal information service (D-OTIS), digital weather information services (D-METAR or TWIP), data link-flight information service (D-FIS) and Notice to Airmen (electronic NOTAM) delivery.	C
5	Broadcast surveillance	This includes elementary and enhanced surveillance systems, as well as automatic dependent surveillance-broadcast (ADS-B) output data.	M*, F2
6	AOC data	This includes any application transmitting or receiving data used for AOC purposes (in accordance with the ICAO definition of AOC). Such systems may also process AAC messages, but there is no requirement to record AAC messages	M*
7	Graphics	This includes any application receiving graphical data to be used for operational purposes (i.e. excluding applications that are receiving such things as updates to manuals).	M* F1

GM1 SPO.IDE.H.150 Data link recording

GENERAL

- (a) The letters and expressions in Table 1 of AMC1-SPO.IDE.H.150 have the following meaning:
- (1) C: complete contents recorded.
 - (2) M: information that enables correlation with any associated records stored separately from the helicopter.
 - (3) *: applications that are to be recorded only as far as is practicable, given the architecture of the system.

- (4) F1: graphics applications may be considered as AOC messages when they are part of a data link communications application service run on an individual basis by the operator itself in the framework of the operational control.
- (5) F2: where parametric data sent by the helicopter, such as Mode S, is reported within the message, it should be recorded unless data from the same source is recorded on the FDR.
- (b) The definitions of the applications type in Table 1 of AMC2 SPO.IDE.H.150 are described in Table 1 below.

Table 1: Definitions of the applications type

Item No	Application Type	Messages	Comments
1	CM		CM is an ATN service
2	AFN		AFN is a FANS 1/A service
3	CPDLC		All implemented up and downlink messages to be recorded
4	ADS-C	ADS-C reports	All contract requests and reports recorded
		Position reports	Only used within FANS 1/A. Mainly used in oceanic and remote areas.
5	ADS-B	Surveillance data	Information that enables correlation with any associated records stored separately from the helicopter.
6	D-FIS		D-FIS is an ATN service. All implemented up and downlink messages to be recorded
7	TWIP	TWIP messages	Terminal weather information for pilots
8	D ATIS	ATIS messages	Refer to EUROCAE ED-89A, dated December 2003: Data Link Application System Document (DLASD) for the 'ATIS' data link service
9	OCL	OCL messages	Refer to EUROCAE ED-106A, dated March 2004: Data Link Application System Document (DLASD) for 'Oceanic Clearance' (OCL) data link service
10	DCL	DCL messages	Refer to EUROCAE ED-85A, dated March 2003: Data Link Application System Document (DLASD) for 'Departure Clearance' data link service
11	Graphics	Weather maps & other graphics	Graphics exchanged in the framework of procedures within the operational control, as specified in Part-ORO.

Item No	Application Type	Messages	Comments
			Information that enables correlation with any associated records stored separately from the helicopter.
12	AOC	Aeronautical operational control messages	Messages exchanged in the framework of procedures within the operational control, as specified in Part-ORO. Information that enables correlation with any associated records stored separately from the helicopter. Definition in EUROCAE ED-112, dated March 2003.
13	Surveillance	Downlinked Aircraft Parameters (DAP)	As defined in ICAO Annex 10 Volume IV (Surveillance systems and ACAS).

AAC	aeronautical administrative communications
ADS-B	automatic dependent surveillance — broadcast
ADS-C	automatic dependent surveillance — contract
AFN	aircraft flight notification
AOC	aeronautical operational control
ATIS	automatic terminal information service
ATSC	air traffic service communication
CAP	controller access parameters
CPDLC	controller pilot data link communications
CM	configuration/context management
D-ATIS	digital ATIS
D-FIS	data link flight information service
D-METAR	data link meteorological airport report
DCL	departure clearance
FANS	Future Air Navigation System
FLIPCY	flight plan consistency
OCL	oceanic clearance
SAP	system access parameters
TWIP	terminal weather information for pilots

GM1 SPO.IDE.H.150(a) Data link recording

APPLICABILITY OF THE DATA LINK RECORDING REQUIREMENT

- (a) If it is certain that the helicopter cannot use data link communication messages for ATS communications corresponding to any application designated by SPO.IDE.H.150(a)(1), then the data link recording requirement does not apply.
- (b) Examples where the helicopter cannot use data link communication messages for ATS communications include but are not limited to the cases where:
 - (1) the helicopter data link communication capability is disabled permanently and in a way that it cannot be enabled again during the flight;
 - (2) data link communications are not used to support air traffic service (ATS) in the area of operation of the helicopter; and
 - (3) the helicopter data link communication equipment cannot communicate with the equipment used by ATS in the area of operation of the helicopter.

SPO.IDE.H.155 Flight data and cockpit voice combination recorder

Compliance with CVR and FDR requirements may be achieved by one flight data and cockpit voice combination recorder.

GM1 SPO.IDE.H.155 Flight data and cockpit voice combination recorder

COMBINATION RECORDERS

- (a) A flight data and cockpit voice combination recorder is a flight recorder that records:
 - (1) all voice communications and the aural environment required by SPO.IDE.H.140; and
 - (2) all parameters and specifications required by SPO.IDE.H.145,with the same specifications required by SPO.IDE.H.140 and SPO.IDE.H.145.
- (b) In addition, a flight data and cockpit voice combination recorder may record data link communication messages and related information required by SPO.IDE.H.150.

SPO.IDE.H.160 Seats, seat safety belts and restraint systems

- (a) Helicopters shall be equipped with:
- (1) a seat or station for each crew member or task specialist on board;
 - (2) a seat belt on each seat, and restraint devices for each station;
 - (3) for helicopters first issued with an individual CofA after 31 December 2012, a seat belt with an upper torso restraint system for each seat; and
 - (4) a seat belt with upper torso restraint system incorporating a device that will automatically restrain the occupant's torso in the event of rapid deceleration on each flight crew seat.
- (b) A seat belt with upper torso restraint system shall have a single point release.

AMC2 SPO.IDE.H.160 Seats, seat safety belts and restraint systems**UPPER TORSO RESTRAINT SYSTEM**

The following systems are deemed to be compliant with the requirement for an upper torso restraint system:

- (a) For other-than complex helicopters, a seat belt with a diagonal shoulder strap;
- (b) For all helicopters, a restraint system having a seat belt and two shoulder straps that may be used independently.
- (c) For all helicopters, a restraint system having a seat belt, two shoulder straps and additional straps that may be used independently.

SEAT BELT

A seat belt with a diagonal shoulder strap (three anchorage points) is deemed to be compliant with the requirement for a seat belt (two anchorage points).

SPO.IDE.H.165 First-aid kit

- (a) Helicopters shall be equipped with a first-aid kit.
- (b) The first-aid kit shall be:
 - (1) readily accessible for use; and
 - (2) kept up-to-date.

AMC1 SPO.IDE.H.165 First-aid kit

CONTENT OF FIRST-AID KITS — OTHER-THAN COMPLEX MOTOR-POWERED HELICOPTERS

- (a) First-aid kits should be equipped with appropriate and sufficient medications and instrumentation. However, these kits should be amended by the operator according to the characteristics of the operation (scope of operation, flight duration, number and demographics of persons on board, etc.).
- (b) The following should be included in the FAKs:
 - (1) bandages (assorted sizes),
 - (2) burns dressings (large and small),
 - (3) wound dressings (large and small),
 - (4) adhesive dressings (assorted sizes),
 - (5) antiseptic wound cleaner,
 - (6) safety scissors, and
 - (7) disposable gloves.

AMC2 SPO.IDE.H.165 First-aid kit

CONTENT OF FIRST-AID KIT — COMPLEX MOTOR-POWERED HELICOPTERS

- (a) First-aid kits should be equipped with appropriate and sufficient medications and instrumentation. However, these kits should be amended by the operator according to the characteristics of the operation (scope of operation, flight duration, number and demographics of persons on board etc.).
- (b) The following should be included in the FAKs:
 - (1) Equipment:
 - (i) bandages (assorted sizes);
 - (ii) burns dressings (unspecified);
 - (iii) wound dressings (large and small);
 - (iv) adhesive dressings (assorted sizes);
 - (v) adhesive tape;
 - (vi) adhesive wound closures;
 - (vii) safety pins;
 - (viii) safety scissors;
 - (ix) antiseptic wound cleaner;

- (x) disposable resuscitation aid;
 - (xi) disposable gloves;
 - (xii) tweezers: splinter; and
 - (xiii) thermometers (non-mercury).
- (2) Medications:
- (i) simple analgesic (may include liquid form);
 - (ii) antiemetic;
 - (iii) nasal decongestant;
 - (iv) gastrointestinal antacid, in the case of helicopters carrying more than nine persons;
 - (v) anti-diarrhoeal medication in the case of helicopters carrying more than nine persons; and
 - (vi) antihistamine.
- (3) Other:
- (i) a list of contents in at least two languages (English and one other). This should include information on the effects and side effects of medications carried;
 - (ii) first-aid handbook;
 - (iii) medical incident report form; and
 - (iv) biohazard disposal bags.
- (4) An eye irrigator, although not required to be carried in the FAK, should, where possible, be available for use on the ground.

AMC3 SPO.IDE.H.165 First-aid kit

MAINTENANCE OF FIRST-AID KIT

To be kept up to date, the first-aid kit should be:

- (a) inspected periodically to confirm, to the extent possible, that contents are maintained in the condition necessary for their intended use;
- (b) replenished at regular intervals, in accordance with instructions contained on their labels, or as circumstances warrant; and
- (c) replenished after use in-flight at the first opportunity where replacement items are available.

SPO.IDE.H.175 Supplemental oxygen — non-pressurised helicopters

- (a) Non-pressurised helicopters operated at flight altitudes when the oxygen supply is required in accordance with (b) shall be equipped with oxygen storage and dispensing apparatus capable of storing and dispensing the required oxygen supplies.
- (b) Non-pressurised helicopters operated above flight altitudes at which the pressure altitude in the cabin compartments is above 10 000 ft shall carry enough breathing oxygen to supply:
 - (1) all crew members for any period in excess of 30 minutes when the pressure altitude in the cabin compartment will be between 10 000 ft and 13 000 ft; and
 - (2) all crew members and task specialists for any period that the pressure altitude in the cabin compartment will be above 13 000 ft.
- (c) Notwithstanding (b), excursions of a specified duration between 13 000 ft and 16 000 ft may be undertaken without oxygen supplies, -in accordance with SPO.OP.195(b).

AMC1 SPO.IDE.H.175 Supplemental oxygen — non-pressurised helicopters

DETERMINATION OF OXYGEN

The amount of oxygen should be determined on the basis of cabin pressure altitude and flight duration, consistent with the operating procedures, including emergency, procedures, established for each operation and the routes to be flown as specified in the AFM.

SPO.IDE.H.180 Hand fire extinguishers

- (a) Helicopters, except ELA2 helicopters, shall be equipped with at least one hand fire extinguisher:
 - (1) in the flight crew compartment; and
 - (2) in each cabin compartment that is separate from the flight crew compartment, except if the compartment is readily accessible to the flight crew.
- (b) The type and quantity of extinguishing agent for the required fire extinguishers shall be suitable for the type of fire likely to occur in the compartment where the extinguisher is intended to be used and to minimise the hazard of toxic gas concentration in compartments occupied by persons.

AMC1 SPO.IDE.H.180 Hand fire extinguishers

NUMBER, LOCATION AND TYPE

- (a) The number and location of hand fire extinguishers should be such as to provide adequate availability for use, account being taken of the number and size of the cabin compartments, the need to minimise the hazard of toxic gas concentrations and the location of toilets, galleys, etc. These considerations may result in the number of fire extinguishers being greater than the minimum required.
- (b) There should be at least one hand fire extinguisher installed in the flight crew compartment and this should be suitable for fighting both flammable fluid and electrical equipment fires. Additional hand fire extinguishers may be required for the protection of other compartments accessible to the flight crew or task specialist in flight. Dry chemical fire extinguishers should not be used in the flight crew compartment, or in any compartment not separated by a partition from the flight crew compartment, because of the adverse effect on vision during discharge and, if conductive, interference with electrical contacts by the chemical residues.

-
- (c) Where only one hand fire extinguisher is required in the cabin compartments, it should be located near the task specialist's station, where provided.
 - (d) Where two or more hand fire extinguishers are required in the cabin compartments and their location is not otherwise dictated by consideration of (a), an extinguisher should be located near each end of the cabin with the remainder distributed throughout the cabin as evenly as is practicable.
 - (e) Unless an extinguisher is clearly visible, its location should be indicated by a placard or sign. Appropriate symbols may also be used to supplement such a placard or sign.

SPO.IDE.H.185 Marking of break-in points

If areas of the helicopter's fuselage suitable for break-in by rescue crews in an emergency are marked, such areas shall be marked as shown in Figure 1.

Figure 1

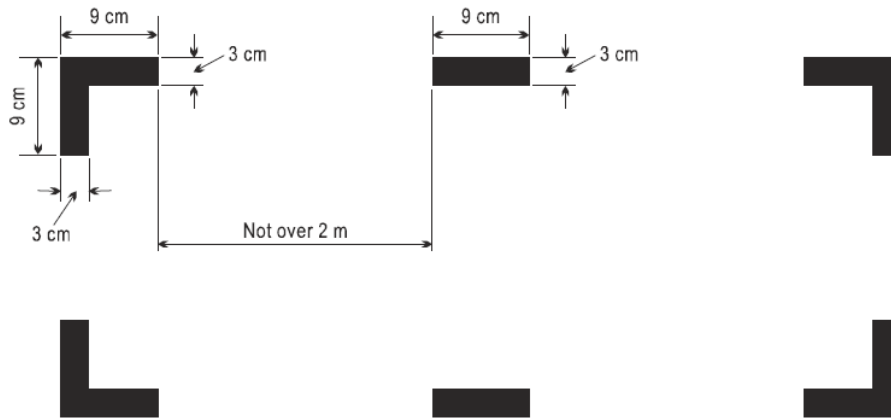
Marking of break-in points**AMC1 SPO.IDE.H.185 Marking of break-in points****COLOUR AND CORNERS' MARKING**

- (a) The colour of the markings should be red or yellow and, if necessary, should be outlined in white to contrast with the background.
- (b) If the corner markings are more than 2 m apart, intermediate lines 9 cm x 3 cm should be inserted so that there is no more than 2 m between adjacent markings.

SPO.IDE.H.190 Emergency locator transmitter (ELT)

- (a) Helicopters certified for a maximum seating configuration above six shall be equipped with:
 - (1) an automatic ELT; and
 - (2) one survival ELT (ELT(S)) in a life-raft or life-jacket when the helicopter is operated at a distance from land corresponding to more than 3 minutes flying time at normal cruising speed.
- (b) Helicopters certified for a maximum seating configuration of six or less shall be equipped with an ELT(S) or a personal locator beacon (PLB), carried by a crew member or a task specialist.
- (c) ELTs of any type and PLBs shall be capable of transmitting simultaneously on 121,5 MHz and 406 MHz.

AMC1 SPO.IDE.H.190 Emergency locator transmitter (ELT)

BATTERIES

- (a) All batteries used in ELTs or PLBs should be replaced (or recharged if the battery is rechargeable) when the equipment has been in use for more than 1 cumulative hour or in the following cases:
 - (1) Batteries specifically designed for use in ELTs and having an airworthiness release certificate (EASA Form 1 or equivalent) should be replaced (or recharged, if the battery is rechargeable) before the end of their useful life in accordance with the maintenance instructions applicable to the ELT.
 - (2) Standard batteries manufactured in accordance with an industry standard and not having an airworthiness release certificate (EASA Form 1 or equivalent), when used in ELTs should be replaced (or recharged if the battery is rechargeable) when 50 % of their useful life (or for rechargeable, 50 % of their useful life of charge), as established by the battery manufacturer, has expired.
 - (3) All batteries used in PLBs should be replaced (or recharged, if the battery is rechargeable) when 50 % of their useful life (or for rechargeable 50 % of their useful life of charge), as established by the battery manufacturer, has expired.
 - (4) The battery useful life (or useful life of charge) criteria in (1),(2) and (3) do not apply to batteries (such as water-activated batteries) that are essentially unaffected during probable storage intervals.
- (b) The new expiry date for a replaced (or recharged) battery should be legibly marked on the outside of the equipment.

AMC2 SPO.IDE.H.190 Emergency locator transmitter (ELT)

TYPES OF ELT AND GENERAL TECHNICAL SPECIFICATIONS

- (a) The ELT required by this provision should be one of the following:
 - (1) Automatic fixed (ELT(AF)). An automatically activated ELT that is permanently attached to an aircraft and is designed to aid SAR teams in locating the crash site.
 - (2) Automatic portable (ELT(AP)). An automatically activated ELT that is rigidly attached to an aircraft before a crash, but is readily removable from the aircraft after a crash. It functions as an ELT during the crash sequence. If the ELT does not employ an integral antenna, the aircraft-mounted antenna may be disconnected and an auxiliary antenna (stored on the

ELT case) attached to the ELT. The ELT can be tethered to a survivor or a life-raft. This type of ELT is intended to aid SAR teams in locating the crash site or survivor(s).

- (3) Automatic deployable (ELT(AD)). An ELT that is rigidly attached to the aircraft before the crash and that is automatically ejected, deployed and activated by an impact, and, in some cases, also by hydrostatic sensors. Manual deployment is also provided. This type of ELT should float in water and is intended to aid SAR teams in locating the crash site.
 - (4) Survival ELT (ELT(S)). An ELT that is removable from an aircraft, stowed so as to facilitate its ready use in an emergency, and manually activated by a survivor. An ELT(S) may be activated manually or automatically (e.g. by water activation). It should be designed to be tethered to a life-raft or a survivor.
- (b) To minimise the possibility of damage in the event of crash impact, the automatic ELT should be rigidly fixed to the aircraft structure, as far aft as is practicable, with its antenna and connections arranged so as to maximise the probability of the signal being transmitted after a crash.
 - (c) Any ELT carried should operate in accordance with the relevant provisions of ICAO Annex 10, Volume III and should be registered with the national agency responsible for initiating search and rescue or other nominated agency.

AMC3 SPO.IDE.H.190 Emergency locator transmitter (ELT)

PLB TECHNICAL SPECIFICATIONS

- (a) A personal locator beacon (PLB) should have a built-in GNSS receiver with a *cosmicheskaya sistyema poiska avariynich sudov* — search and rescue satellite-aided tracking (COSPAS-SARSAT) type approval number. However, devices with a COSPAS-SARSAT with a number belonging to series 700 are excluded as this series of numbers identifies the special-use beacons not meeting all the technical requirements and all the tests specified by COSPAS-SARSAT.
- (b) Any PLB carried should be registered with the national agency responsible for initiating search and rescue or other nominated agency.

AMC4 SPO.IDE.H.190 Emergency locator transmitter (ELT)

BRIEFING ON PLB USE

When a PLB is carried by a task specialist, he/she should be briefed on its characteristics and use by the pilot-in-command before the flight.

GM1 SPO.IDE.H.190 Emergency locator transmitter (ELT)

TERMINOLOGY

- (a) An ELT is a generic term describing equipment that broadcasts distinctive signals on designated frequencies and, depending on application, may be activated by impact or may be manually activated.
- (b) A PLB is an emergency beacon other than an ELT that broadcasts distinctive signals on designated frequencies, is standalone, portable and is manually activated by the survivors.

GM2 SPO.IDE.H.190 Emergency locator transmitter (ELT)

MAXIMUM CERTIFIED SEATING CONFIGURATION

The maximum certified seating configuration does not include flight crew seats.

SPO.IDE.H.195 Flight over water — other-than complex motor-powered helicopters

- (a) Helicopters shall be equipped with a life-jacket for each person on board, that shall be worn or stowed in a position that is readily accessible from the seat or station of the person for whose use it is provided, when:
- (1) flying over water beyond autorotational distance from the land where in case of the critical engine failure, the helicopter is not able to sustain level flight; or
 - (2) flying over water at a distance of land corresponding to more than 10 minutes flying at normal cruising speed, where in case of the critical engine failure, the helicopter is able to sustain level flight; or
 - (3) taking off or landing at an aerodrome/operating site where the take-off or approach path is over water.
- (b) Each life-jacket shall be equipped with a means of electric illumination for the purpose of facilitating the location of persons.
- (c) The pilot-in-command of a helicopter operated on a flight over water at a distance from land corresponding to more than 30 minutes flying time at normal cruising speed or 50 NM, whichever is less, shall determine the risks to survival of the occupants of the helicopter in the event of a ditching, based on which he/she shall determine the carriage of:
- (1) equipment for making the distress signals;
 - (2) life-rafts in sufficient numbers to carry all persons on board, stowed so as to facilitate their ready use in emergency; and
 - (3) life-saving equipment to provide the means of sustaining life, as appropriate to the flight to be undertaken.
- (d) The pilot-in-command shall determine the risks to survival of the occupants of the helicopter in the event of a ditching, when deciding if the life-jackets required in (a) shall be worn by all occupants.

AMC1 SPO.IDE.H.195 Flight over water — other-than complex motor-powered helicopters**ACCESSIBILITY OF LIFE-JACKETS**

The life-jacket, if not worn, should be accessible from the seat or station of the person for whose use it is provided, with a safety belt or a restraint system fastened.

MEANS OF ILLUMINATION FOR LIFE-JACKETS

The means of electric illumination should be a survivor locator light as defined in the applicable ETSO issued by the Agency or equivalent.

RISK ASSESSMENT

- (a) When conducting the risk assessment, the pilot-in-command should base his/her decision, as far as is practicable, on the Implementing Rules and AMCs applicable to the operation of the helicopter.
- (b) The pilot-in-command should, for determining the risk, take the following operating environment and conditions into account:
- (1) sea state;

-
- (2) sea and air temperatures;
 - (3) the distance from land suitable for making an emergency landing; and
 - (4) the availability of search and rescue facilities.

GM1 SPO.IDE.H.195 Flight over water — other-than complex motor-powered helicopters

SEAT CUSHIONS

Seat cushions are not considered to be flotation devices.

SPO.IDE.H.197 Life-jackets — complex motor-powered helicopters

- (a) Helicopters shall be equipped with a life-jacket for each person on board, that shall be worn or stowed in a position that is readily accessible from the seat or station of the person for whose use it is provided, when:
- (1) operated on a flight over water at a distance from land corresponding to more than 10 minutes flying time at normal cruising speed, where in the case of the critical engine failure, the helicopter is able to sustain level flight;
 - (2) operated on a flight over water beyond auto-rotational distance from the land, where in the case of the critical engine failure, the helicopter is not able to sustain level flight; or
 - (3) taking off or landing at an aerodrome or operating site where the take-off or approach path is so disposed over water that in the event of a mishap there would be the likelihood of a ditching.
- (b) Each life-jacket shall be equipped with a means of electric illumination for the purpose of facilitating the location of persons.

AMC1 SPO.IDE.H.197 Life-jackets — complex motor-powered helicopters

ACCESSIBILITY OF LIFE-JACKETS

The life-jacket, if not worn, should be accessible from the seat or station of the person for whose use it is provided, with a safety belt or a restraint system fastened.

MEANS OF ILLUMINATION FOR LIFE-JACKETS

The means of electric illumination should be a survivor locator light as defined in the applicable ETSO issued by the Agency or equivalent.

GM1 SPO.IDE.H.197 Life-jackets – complex motor-powered helicopters

SEAT CUSHIONS

Seat cushions are not considered to be flotation devices.

SPO.IDE.H.198 Survival suits — complex motor-powered helicopters

Each person on board shall wear a survival suit when operating:

- (a) on a flight over water in support of offshore operations, at a distance from land corresponding to more than 10 minutes flying time at normal cruising speed, where in the case of the critical engine failure, the helicopter is able to sustain level flight and when:
- (1) the weather report or forecasts available to the pilot-in-command indicate that the sea temperature will be less than plus 10 °C during the flight; or
 - (2) the estimated rescue time exceeds the estimated survival time; or
- (b) so determined by the pilot-in-command based on a risk assessment taking into account the following conditions:
- (1) flights over water beyond auto-rotational distance or safe forced landing distance from land, where in the case of the critical engine failure, the helicopter is not able to sustain level flight; and
 - (2) the weather report or forecasts available to the pilot-in-command indicate that the sea temperature will be less than plus 10 °C during the flight.

Applicable until 01 July 2018, then replaced by the text below

SPO.IDE.H.198 Survival suits — complex motor-powered helicopters

Each person on board shall wear a survival suit when so determined by the pilot-in-command based on a risk assessment taking into account the following conditions:

- (a) flights over water beyond autorotational distance or safe forced-landing distance from land, where, in the case of a critical engine failure, the helicopter is not able to sustain level flight; and
- (b) the weather report or forecasts available to the pilot-in-command indicate that the sea temperature will be less than plus 10 °C during the flight.

Applicable from 01 July 2018. Will replace the text above.

GM1 SPO.IDE.H.198 Survival suits — complex motor-powered helicopters**ESTIMATING SURVIVAL TIME**

- (a) Introduction
- (1) A person accidentally immersed in cold seas (typically offshore Northern Europe) will have a better chance of survival if he/she is wearing an effective survival suit in addition to a life-jacket. By wearing the survival suit, he/she can slow down the rate which his/her body temperature falls and, consequently, protect himself/herself from the greater risk of drowning brought about by incapacitation due to hypothermia.
 - (2) The complete survival suit system – suit, life-jacket and clothes worn under the suit – should be able to keep the wearer alive long enough for the rescue services to find and recover him/her. In practice the limit is about 3 hours. If a group of persons in the water cannot be rescued within this time they are likely to have become so scattered and separated that location will be extremely difficult, especially in the rough water typical of Northern European sea areas. If it is expected that in water protection could be required for periods greater than 3 hours, improvements should, rather, be sought in the search and rescue procedures than in the immersion suit protection.
- (b) Survival times
- (1) The aim should be to ensure that a person in the water can survive long enough to be rescued, i.e. the survival time should be greater than the likely rescue time. The factors

affecting both times are shown in Figure 1. The figure emphasises that survival time is influenced by many factors, physical and human. Some of the factors are relevant to survival in cold water and some are relevant in water at any temperature.

Figure 1: The survival equation

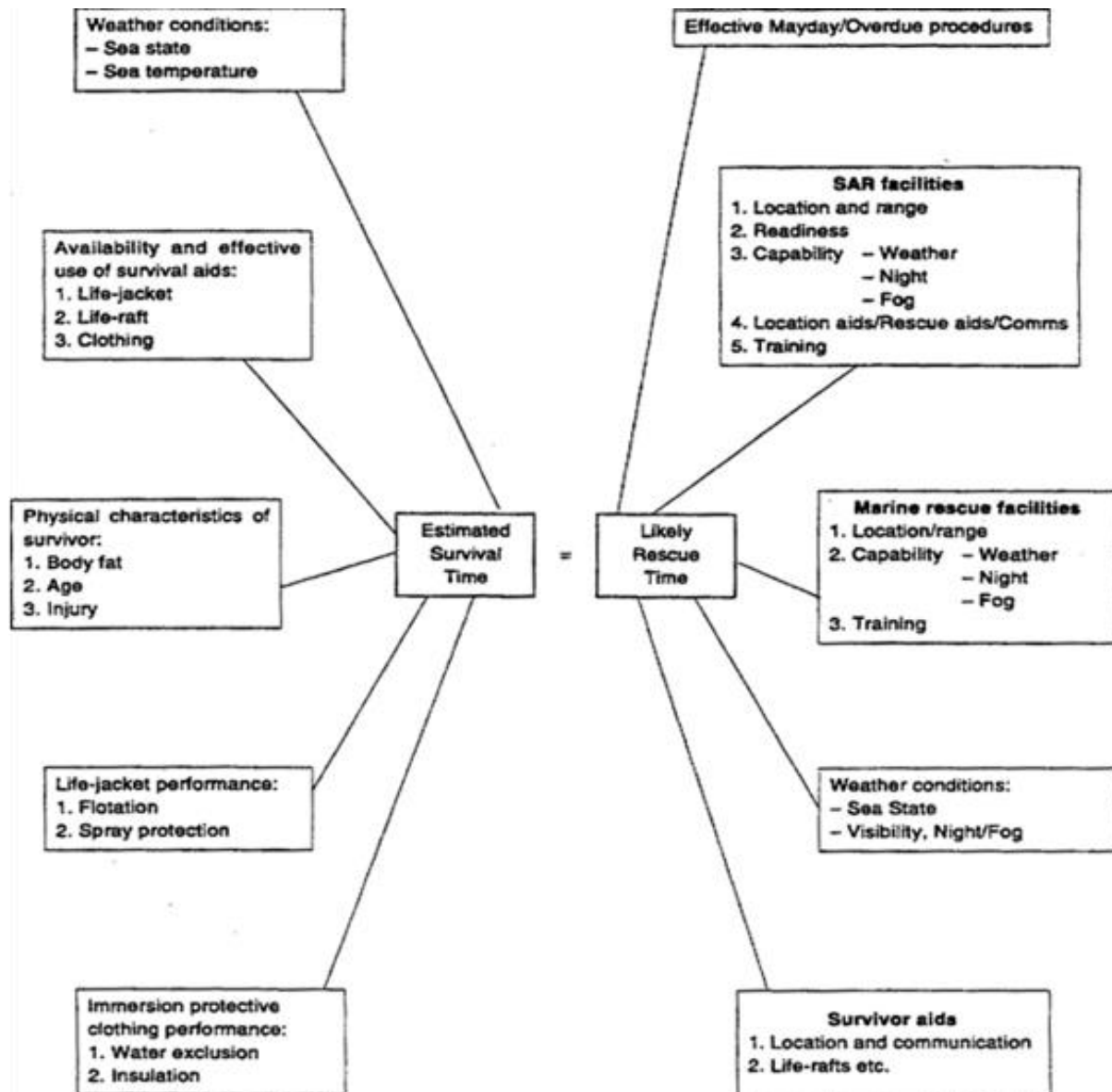

(2) Broad estimates of likely survival times for the thin individual offshore are given in Table 1 below. As survival time is significantly affected by the prevailing weather conditions at the time of immersion, the Beaufort wind scale has been used as an indicator of these surface conditions.

Table 1: Timescale within which the most vulnerable individuals are likely to succumb to the prevailing conditions.

Clothing assembly	Beaufort wind force	Times within which the most vulnerable individuals are likely to drown	
		(water temp 5°C)	(water temp 13°C)
Working clothes	0 – 2	Within ¾ hour	Within 1 ¼ hours

Clothing assembly	Beaufort wind force	Times within which the most vulnerable individuals are likely to drown	
		(water temp 5°C)	(water temp 13°C)
(no immersion suit)	3 – 4	Within ½ hour	Within ½ hour
	5 and above	Significantly less than ½ hour	Significantly less than ½ hour
Immersion suit worn over working clothes (with leakage inside suit)	0 – 2	May well exceed 3 hours	May well exceed 3 hours
	3 – 4	Within 2 ¾ hours	May well exceed 3 hours
	5 and above	Significantly less than 2 ¾ hours. May well exceed 1 hour	May well exceed 3 hours

- (3) Consideration should also be given to escaping from the helicopter itself should it submerge or invert in the water. In this case escape time is limited to the length of time the occupants can hold their breath. The breath holding time can be greatly reduced by the effect of cold shock. Cold shock is caused by the sudden drop in skin temperature on immersion, and is characterised by a gasp reflex and uncontrolled breathing. The urge to breath rapidly becomes overwhelming and, if still submerged, the individual will inhale water resulting in drowning. Delaying the onset of cold shock by wearing an immersion suit will extend the available escape time from a submerged helicopter.
- (4) The effects of water leakage and hydrostatic compression on the insulation quality of clothing are well recognised. In a nominally dry system the insulation is provided by still air trapped within the clothing fibres and between the layers of suit and clothes. It has been observed that many systems lose some of their insulating capacity either because the clothes under the 'waterproof' survival suit get wet to some extent or because of hydrostatic compression of the whole assembly. As a result of water leakage and compression, survival times will be shortened. The wearing of warm clothing under the suit is recommended.
- (5) Whatever type of survival suit and other clothing is provided, it should not be forgotten that significant heat loss can occur from the head.

SPO.IDE.H.199 Life-rafts, survival ELTs and survival equipment on extended overwater flights — complex motor-powered helicopters

Helicopters operated:

- (a) on a flight over water at a distance from land corresponding to more than 10 minutes flying time at normal cruising speed where in the case of the critical engine failure, the helicopter is able to sustain level flight; or
- (b) on a flight over water at a distance corresponding to more than 3 minutes flying time at normal cruising speed, where in the case of the critical engine failure, the helicopter is not able to sustain level flight, and if so determined by the pilot-in-command by means of a risk assessment, shall be equipped with:
 - (1) at least one life-raft with a rated capacity of not less than the maximum number of persons on board, stowed so as to facilitate their ready use in emergency;
 - (2) at least one survival ELT (ELT(S)) for each required life-raft; and
 - (3) life-saving equipment, including means of sustaining life, as appropriate to the flight to be undertaken.

AMC1 SPO.IDE.H.199 Life-rafts, survival ELTs and survival equipment on extended overwater flights — complex motor-powered helicopters**LIFE-RAFTS AND EQUIPMENT FOR MAKING DISTRESS SIGNALS**

- (a) Each required life-raft should conform to the following specifications:
 - (1) be of an approved design and stowed so as to facilitate their ready use in an emergency;
 - (2) be radar conspicuous to standard airborne radar equipment;
 - (3) when carrying more than one life-raft on board, at least 50 % of the rafts should be able to be deployed by the crew while seated at their normal station, where necessary by remote control; and
 - (4) life-rafts that are not deployable by remote control or by the crew should be of such weight as to permit handling by one person. 40 kg should be considered a maximum weight.
- (b) Each required life-raft should contain at least the following:
 - (1) one approved survivor locator light;
 - (2) one approved visual signalling device;
 - (3) one canopy (for use as a sail, sunshade or rain catcher) or other mean to protect occupants from the elements;
 - (4) one radar reflector;
 - (5) one 20 m retaining line designed to hold the life-raft near the helicopter but to release it if the helicopter becomes totally submerged;
 - (6) one sea anchor; and
 - (7) one survival kit, appropriately equipped for the route to be flown, which should contain at least the following:
 - (i) one life-raft repair kit;
 - (ii) one bailing bucket;

-
- (iii) one signalling mirror;
 - (iv) one police whistle;
 - (v) one buoyant raft knife;
 - (vi) one supplementary means of inflation;
 - (vii) sea sickness tablets;
 - (viii) one first-aid kit;
 - (ix) one portable means of illumination;
 - (x) 500 ml of pure water and one sea water desalting kit; and
 - (xi) one comprehensive illustrated survival booklet in an appropriate language.

SPO.IDE.H.200 Survival equipment

Helicopters operated over areas in which search and rescue would be especially difficult shall be equipped with:

- (a) signalling equipment to make distress signals;
- (b) at least one survival ELT (ELT(S)); and
- (c) additional survival equipment for the route to be flown taking account of the number of persons on board.

AMC1 SPO.IDE.H.200 Survival equipment

ADDITIONAL SURVIVAL EQUIPMENT

- (a) The following additional survival equipment should be carried when required:
 - (1) 500 ml of water for each four, or fraction of four, persons on board;
 - (2) one knife;
 - (3) first-aid equipment; and
 - (4) one set of air/ground codes.
- (b) In addition, when polar conditions are expected, the following should be carried:
 - (1) a means of melting snow;
 - (2) one snow shovel and one ice saw;
 - (3) sleeping bags for use by 1/3 of all persons on board and space blankets for the remainder or space blankets for all persons on board; and
 - (4) one arctic/polar suit for each crew member.
- (c) If any item of equipment contained in the above list is already carried on board the aircraft in accordance with another requirement, there is no need for this to be duplicated.

AMC1 SPO.IDE.H.200(b) Survival equipment

SURVIVAL ELT

An ELT(AP) may be used to replace one required ELT(S) provided that it meets the ELT(S) requirements. A water-activated ELT(S) is not an ELT(AP).

GM1 SPO.IDE.H.200 Survival equipment

SIGNALLING EQUIPMENT

The signalling equipment for making distress signals is described in ICAO Annex 2, Rules of the Air.

GM2 SPO.IDE.H.200 Survival equipment

AREAS IN WHICH SEARCH AND RESCUE WOULD BE ESPECIALLY DIFFICULT

The expression 'areas in which search and rescue would be especially difficult' should be interpreted, in this context, as meaning:

- (a) areas so designated by the authority responsible for managing search and rescue; or

-
- (b) areas that are largely uninhabited and where:
- (1) the authority referred to in (a) has not published any information to confirm whether search and rescue would be or would not be especially difficult; and
 - (2) the authority referred to in (a) does not, as a matter of policy, designate areas as being especially difficult for search and rescue.

Applicable until 01 July 2018, then deleted

SPO.IDE.H.201 Additional requirements for helicopters conducting offshore operations in a hostile sea area — complex motor-powered helicopters

Helicopters operated in offshore operations in a hostile sea area, at a distance from land corresponding to more than 10 minutes flying time at normal cruising speed, shall comply with the following:

- (a) When the weather report or forecasts available to the pilot-in-command indicate that the sea temperature will be less than plus 10 °C during the flight, or when the estimated rescue time exceeds the calculated survival time, or the flight is planned to be conducted at night, all crew members and task specialists on board are wearing a survival suit.
- (b) All life-rafts carried in accordance with SPO.IDE.H.199 shall be installed so as to be usable in the sea conditions in which the helicopter's ditching, flotation and trim characteristics were evaluated in order to comply with the ditching requirements for certification.
- (c) The helicopter shall be equipped with an emergency lighting system with an independent power supply to provide a source of general cabin illumination to facilitate the evacuation of the helicopter.
- (d) All emergency exits, including crew emergency exits, and the means of opening them shall be conspicuously marked for the guidance of occupants using the exits in daylight or in the dark. Such markings shall be designed to remain visible if the helicopter is capsized and the cabin is submerged.
- (e) All non-jettisonable doors that are designated as ditching emergency exits shall have a means of securing them in the open position so that they do not interfere with occupants' egress in all sea conditions up to the maximum required to be evaluated for ditching and flotation.
- (f) All doors, windows or other openings in the cabin compartment intended to be used for the purpose of underwater escape shall be equipped so as to be operable in an emergency.
- (g) Life-jackets shall be worn at all times, unless the task specialist or crew member for whose use the life jacket is provided is wearing an integrated survival suit that meets the combined requirement of the survival suit and life-jacket.

This AMC is applicable until 01 July 2018, then deleted.

AMC1 SPO.IDE.H.201 Additional requirements for helicopters conducting offshore operations in a hostile sea area — complex motor-powered helicopters

INSTALLATION OF THE LIFE RAFT

- (a) Projections on the exterior surface of the helicopter, that are located in a zone delineated by boundaries that are 1.22 m (4 ft) above and 0.61 m (2 ft) below the established static water line could cause damage to a deployed life-raft. Examples of projections which need to be considered are aerials, overboard vents, unprotected split-pin tails, guttering and any projection sharper than a three dimensional right angled corner.
- (b) While the boundaries specified in (1) are intended as a guide, the total area that should be considered should also take into account the likely behaviour of the life-raft after deployment in all sea states up to the maximum in which the helicopter is capable of remaining upright.
- (c) Wherever a modification or alteration is made to a helicopter within the boundaries specified, the need to prevent the modification or alteration from causing damage to a deployed life-raft should be taken into account in the design.
- (d) Particular care should also be taken during routine maintenance to ensure that additional hazards are not introduced by, for example, leaving inspection panels with sharp corners proud

of the surrounding fuselage surface, or allowing door sills to deteriorate to a point where sharp edges become a hazard.

SPO.IDE.H.202 Helicopters certified for operating on water — miscellaneous equipment

Helicopters certified for operating on water shall be equipped with:

- (a) a sea anchor and other equipment necessary to facilitate mooring, anchoring or manoeuvring the helicopter on water, appropriate to its size, weight and handling characteristics; and
- (b) equipment for making the sound signals prescribed in the International Regulations for Preventing Collisions at Sea, where applicable.

GM1 SPO.IDE.H.202 Helicopters certificated for operating on water — miscellaneous equipment**INTERNATIONAL REGULATIONS FOR PREVENTING COLLISIONS AT SEA**

International Regulations for Preventing Collisions at Sea are those that were published by the International Maritime Organisation (IMO) in 1972.

SPO.IDE.H.203 All helicopters on flights over water — ditching

Complex motor-powered helicopters operated on a flight over water in a hostile environment at a distance from land corresponding to more than 10 minutes' flying time at normal cruising speed and other-than complex motor-powered helicopters flying over water in a hostile environment beyond a distance of 50 NM from land shall be:

- (a) designed for landing on water in accordance with the relevant airworthiness code;
- (b) certified for ditching in accordance with the relevant airworthiness code; or
- (c) fitted with emergency flotation equipment.

AMC1 SPO.IDE.H.203 All helicopters on flights over water — ditching**EMERGENCY FLOTATION EQUIPMENT**

The same considerations of AMC1 SPO.IDE.H.201 should apply in respect of emergency flotation equipment.

The considerations of AMC1 SPA.HOFO.165(d) should apply in respect of emergency flotation equipment.

Grey text shall be applicable until 01 July 2018, then replaced by paragraph below it.

SPO.IDE.H.205 Individual protective equipment

Each person on board shall wear individual protective equipment that is adequate for the type of operation being undertaken.

GM1 SPO.IDE.H.205 Individual protective equipment

TYPES OF INDIVIDUAL PROTECTIVE EQUIPMENT

Personal protective equipment should include, but is not limited to: flying suits, gloves, helmets, protective shoes, etc.

SPO.IDE.H.210 Headset

Whenever a radio communication and/or radio navigation system is required, helicopters shall be equipped with a headset with boom microphone or equivalent and a transmit button on the flight controls for each required pilot, crew member and/or task specialist at his/her assigned station.

AMC1 SPO.IDE.H.210 Headset

GENERAL

- (a) A headset consists of a communication device that includes two earphones to receive and a microphone to transmit audio signals to the helicopter's communication system. To comply with the minimum performance requirements, the earphones and microphone should match the communication system's characteristics and the flight crew compartment environment. The headset should be adequately adjustable in order to fit the flight crew's head. Headset boom microphones should be of the noise cancelling type.
- (b) If the intention is to utilise noise cancelling earphones, the operator should ensure that the earphones do not attenuate any aural warnings or sounds necessary for alerting the flight crew on matters related to the safe operation of the helicopter.

GM1 SPO.IDE.H.210 Headset

GENERAL

The term 'headset' includes any aviation helmet incorporating headphones and microphone worn by a flight crew member.

SPO.IDE.H.215 Radio communication equipment

- (a) Helicopters operated under IFR or at night, or when required by the applicable airspace requirements, shall be equipped with radio communication equipment that, under normal radio propagating conditions, shall be capable of:
 - (1) conducting two-way communication for aerodrome control purposes;
 - (2) receiving meteorological information;
 - (3) conducting two-way communication at any time during flight with those aeronautical stations and on those frequencies prescribed by the appropriate authority; and
 - (4) providing for communication on the aeronautical emergency frequency 121,5 MHz.
- (b) When more than one communications equipment unit is required, each shall be independent of the other or others to the extent that a failure in any one will not result in failure of any other.
- (c) When a radio communication system is required, and in addition to the flight crew interphone system required in SPO.IDE.H.135, helicopters shall be equipped with a transmit button on the flight controls for each required pilot and crew member at his/her assigned station.

GM1 SPO.IDE.H.215 Radio communication equipment**APPLICABLE AIRSPACE REQUIREMENTS**

For helicopters being operated under European air traffic control, the applicable airspace requirements include the Single European Sky legislation.

SPO.IDE.H.220 Navigation equipment

- (a) Helicopters shall be equipped with navigation equipment that will enable them to proceed in accordance with:
 - (1) the ATS flight plan, if applicable; and
 - (2) the applicable airspace requirements.
- (b) Helicopters shall have sufficient navigation equipment to ensure that, in the event of the failure of one item of equipment at any stage of the flight, the remaining equipment shall allow safe navigation in accordance with (a), or an appropriate contingency action to be completed safely.
- (c) Helicopters operated on flights in which it is intended to land in IMC shall be equipped with navigation equipment capable of providing guidance to a point from which a visual landing can be performed. This equipment shall be capable of providing such guidance for each aerodrome at which it is intended to land in IMC and for any designated alternate aerodromes.
- (d) For PBN operations the aircraft shall meet the airworthiness certification requirements for the appropriate navigation specification.

AMC1 SPO.IDE.H.220 Navigation equipment

NAVIGATION WITH VISUAL REFERENCE TO LANDMARKS — OTHER-THAN COMPLEX HELICOPTERS

Where other-than complex helicopters, with the surface in sight, can proceed according to the ATS flight plan by navigation with visual reference to landmarks, no additional equipment is needed to comply with SPO.IDE.H.220 (a)(1).

GM1 SPO.IDE.H.220 Navigation equipment

AIRCRAFT ELIGIBILITY FOR PBN SPECIFICATION NOT REQUIRING SPECIFIC APPROVAL

- (a) The performance of the aircraft is usually stated in the AFM.
- (b) Where such a reference cannot be found in the AFM, other information provided by the aircraft manufacturer as TC holder, the STC holder or the design organisation having a privilege to approve minor changes may be considered.
- (c) The following documents are considered acceptable sources of information:
 - (1) AFM, supplements thereto, and documents directly referenced in the AFM;
 - (2) FCOM or similar document;
 - (3) Service Bulletin or Service Letter issued by the TC holder or STC holder;
 - (4) approved design data or data issued in support of a design change approval;
 - (5) any other formal document issued by the TC or STC holders stating compliance with PBN specifications, AMC, Advisory Circulars (AC) or similar documents issued by the State of Design; and
 - (6) written evidence obtained from the State of Design.
- (d) Equipment qualification data, in itself, is not sufficient to assess the PBN capabilities of the aircraft, since the latter depend on installation and integration.
- (e) As some PBN equipment and installations may have been certified prior to the publication of the PBN Manual and the adoption of its terminology for the navigation specifications, it is not always possible to find a clear statement of aircraft PBN capability in the AFM. However, aircraft

eligibility for certain PBN specifications can rely on the aircraft performance certified for PBN procedures and routes prior to the publication of the PBN Manual.

- (f) Below, various references are listed which may be found in the AFM or other acceptable documents (see listing above) in order to consider the aircraft's eligibility for a specific PBN specification if the specific term is not used.
- (g) RNAV 5
- (1) If a statement of compliance with any of the following specifications or standards is found in the acceptable documentation as listed above, the aircraft is eligible for RNAV 5 operations.
- (i) B-RNAV;
 - (ii) RNAV 1;
 - (iii) RNP APCH;
 - (iv) RNP 4;
 - (v) A-RNP;
 - (vi) AMC 20-4;
 - (vii) JAA TEMPORARY GUIDANCE MATERIAL, LEAFLET NO. 2 (TGL 2)
 - (viii) JAA AMJ 20X2;
 - (ix) FAA AC 20-130A for en route operations;
 - (x) FAA AC 20-138 for en route operations; and
 - (xi) FAA AC 90-96.
- (h) RNAV 1/RNAV 2
- (1) If a statement of compliance with any of the following specifications or standards is found in the acceptable documentation as listed above, the aircraft is eligible for RNAV 1/RNAV 2 operations.
- (i) RNAV 1;
 - (ii) PRNAV;
 - (iii) US RNAV type A;
 - (iv) FAA AC 20-138 for the appropriate navigation specification;
 - (v) FAA AC 90-100A;
 - (vi) JAA TEMPORARY GUIDANCE MATERIAL, LEAFLET NO. 10 Rev1 (TGL 10);
 - (vii) FAA AC 90-100.
- (2) However, if position determination is exclusively computed based on VOR-DME, the aircraft is not eligible for RNAV 1/RNAV 2 operations.
- (i) RNP 1/RNP 2 continental
- (1) If a statement of compliance with any of the following specifications or standards is found in the acceptable documentation as listed above, the aircraft is eligible for RNP 1/RNP 2 continental operations.
- (i) A-RNP;
 - (ii) FAA AC 20-138 for the appropriate navigation specification; and

- (iii) FAA AC 90-105.
- (2) Alternatively, if a statement of compliance with any of the following specifications or standards is found in the acceptable documentation as listed above and position determination is primarily based on GNSS, the aircraft is eligible for RNP 1/RNP 2 continental operations. However, in these cases, loss of GNSS implies loss of RNP 1/RNP 2 capability.
 - (i) JAA TEMPORARY GUIDANCE MATERIAL, LEAFLET NO. 10 (TGL 10) (any revision); and
 - (ii) FAA AC 90-100.
- (j) RNP APCH — LNAV minima
 - (1) If a statement of compliance with any of the following specifications or standards is found in the acceptable documentation as listed above, the aircraft is eligible for RNP APCH LNAV operations.
 - (i) A-RNP;
 - (ii) AMC 20-27;
 - (iii) AMC 20-28;
 - (iv) FAA AC 20-138 for the appropriate navigation specification; and
 - (v) FAA AC 90-105 for the appropriate navigation specification.
 - (2) Alternatively, if a statement of compliance with RNP 0.3 GNSS approaches in accordance with any of the following specifications or standards is found in the acceptable documentation as listed above, the aircraft is eligible for RNP APCH — LNAV operations. Any limitation such as ‘within the US National Airspace’ may be ignored since RNP APCH procedures are assumed to meet the same ICAO criteria around the world.
 - (i) JAA TEMPORARY GUIDANCE MATERIAL, LEAFLET NO. 3 (TGL 3);
 - (ii) AMC 20-4;
 - (iii) FAA AC 20-130A; and
 - (iv) FAA AC 20-138.
- (k) RNP APCH — LNAV/VNAV minima
 - (1) If a statement of compliance with any of the following specifications or standards is found in the acceptable documentation as listed above, the aircraft is eligible for RNP APCH — LNAV/VNAV operations.
 - (i) A-RNP;
 - (ii) AMC 20-27 with Baro VNAV;
 - (iii) AMC 20-28;
 - (iv) FAA AC 20-138; and
 - (v) FAA AC 90-105 for the appropriate navigation specification.
 - (2) Alternatively, if a statement of compliance with FAA AC 20-129 is found in the acceptable documentation as listed above, and the aircraft complies with the requirements and limitations of EASA SIB 2014-04⁶, the aircraft is eligible for RNP APCH — LNAV/VNAV

⁶ <http://ad.easa.europa.eu/ad/2014-04>

operations. Any limitation such as ‘within the US National Airspace’ may be ignored since RNP APCH procedures are assumed to meet the same ICAO criteria around the world.

(l) RNP APCH — LPV minima

- (1) If a statement of compliance with any of the following specifications or standards is found in the acceptable documentation as listed above, the aircraft is eligible for RNP APCH — LPV operations.
 - (i) AMC 20-28;
 - (ii) FAA AC 20-138 for the appropriate navigation specification; and
 - (iii) FAA AC 90-107.
- (2) For aircraft that have a TAWS Class A installed and do not provide Mode-5 protection on an LPV approach, the DH is limited to 250 ft.

(m) RNAV 10

- (1) If a statement of compliance with any of the following specifications or standards is found in the acceptable documentation as listed above, the aircraft is eligible for RNAV 10 operations.
 - (i) RNP 10;
 - (ii) FAA AC 20-138 for the appropriate navigation specification;
 - (iii) AMC 20-12;
 - (iv) FAA Order 8400.12 (or later revision); and
 - (v) FAA AC 90-105.

(n) RNP 4

- (1) If a statement of compliance with any of the following specifications or standards is found in the acceptable documentation as listed above, the aircraft is eligible for RNP 4 operations.
 - (i) FAA AC 20-138B or later, for the appropriate navigation specification;
 - (ii) FAA Order 8400.33; and
 - (iii) FAA AC 90-105 for the appropriate navigation specification.

(o) RNP 2 oceanic

- (1) If a statement of compliance with FAA AC 90-105 for the appropriate navigation specification is found in the acceptable documentation as listed above, the aircraft is eligible for RNP 2 oceanic operations.
- (2) If the aircraft has been assessed eligible for RNP 4, the aircraft is eligible for RNP 2 oceanic.

(p) Special features

- (1) RF in terminal operations (used in RNP 1 and in the initial segment of the RNP APCH)
 - (i) If a statement of demonstrated capability to perform an RF leg, certified in accordance with any of the following specifications or standards, is found in the acceptable documentation as listed above, the aircraft is eligible for RF in terminal operations:
 - (A) AMC 20-26;

- (B) FAA AC 20-138B or later.
- (ii) If there is a reference to RF and a reference to compliance with AC 90-105, then the aircraft is eligible for such operations.
- (q) Other considerations
 - (1) In all cases, the limitations in the AFM need to be checked, in particular the use of AP or FD which can be required to reduce the FTE primarily for RNP APCH, RNAV 1, and RNP 1.
 - (2) Any limitation such as ‘within the US National Airspace’ may be ignored since RNP APCH procedures are assumed to meet the same ICAO criteria around the world.

GM2 SPO.IDE.H.220 Navigation equipment

GENERAL

- (a) The PBN specifications for which the aircraft complies with the relevant airworthiness criteria are set out in the AFM, together with any limitations to be observed.
- (b) Because functional and performance requirements are defined for each navigation specification, an aircraft approved for an RNP specification is not automatically approved for all RNAV specifications. Similarly, an aircraft approved for an RNP or RNAV specification having a stringent accuracy requirement (e.g. RNP 0.3 specification) is not automatically approved for a navigation specification having a less stringent accuracy requirement (e.g. RNP 4).

RNP 4

- (c) For RNP 4, at least two LRNSs, capable of navigating to RNP 4, and listed in the AFM, may be operational at the entry point of the RNP 4 airspace. If an item of equipment required for RNP 4 operations is unserviceable, then the flight crew may consider an alternate route or diversion for repairs. For multi-sensor systems, the AFM may permit entry if one GNSS sensor is lost after departure, provided one GNSS and one inertial sensor remain available.

SPO.IDE.H.225 Transponder

Where required by the airspace being flown, helicopters shall be equipped with a secondary surveillance radar (SSR) transponder with all the required capabilities.

AMC1 SPO.IDE.H.225 Transponder

GENERAL

- (a) The SSR transponders of helicopters being operated under European air traffic control should comply with any applicable Single European Sky legislation.
- (b) If the Single European Sky legislation is not applicable, the SSR transponders should operate in accordance with the relevant provisions of Volume IV of ICAO Annex 10.

Applicable
from 01
January
2019

SPO.IDE.H.230 Management of aeronautical databases

- (a) Aeronautical databases used on certified aircraft system applications shall meet data quality requirements that are adequate for the intended use of the data.
- (b) The operator shall ensure the timely distribution and insertion of current and unaltered aeronautical databases to all aircraft that require them.
- (c) Notwithstanding any other occurrence reporting requirements as defined in Regulation (EU) No 376/2014, the operator shall report to the database provider instances of erroneous, inconsistent or missing data that might be reasonably expected to constitute a hazard to flight.

In such cases, the operator shall inform flight crew and other personnel concerned, and shall ensure that the affected data is not used.

SECTION 3
Sailplanes**SPO.IDE.S.100 Instruments and equipment — general**

- (a) Instruments and equipment required by this Subpart shall be approved in accordance with the applicable airworthiness requirements if they are:
- (1) used by the flight crew to control the flight path;
 - (2) used to comply with SPO.IDE.S.145;
 - (3) used to comply with SPO.IDE.S.150; or
 - (4) installed in the sailplane.
- (b) The following items, when required by this Subpart, do not need an equipment approval:
- (1) independent portable light,
 - (2) accurate time piece, and
 - (3) survival and signalling equipment.
- (c) Instruments and equipment not required by this Subpart as well as any other equipment that is not required by other applicable Annexes, but is carried on a flight, shall comply with the following:
- (1) the information provided by these instruments, equipment or accessories shall not be used by the flight crew to comply with Annex I to Regulation (EC) No 216/2008; and
 - (2) the instruments and equipment shall not affect the airworthiness of the sailplane, even in the case of failures or malfunction.
- (d) Instruments and equipment shall be readily operable or accessible from the station where the flight crew member that needs to use it is seated.
- (e) All required emergency equipment shall be easily accessible for immediate use.

GM1 SPO.IDE.S.100(a) Instruments and equipment — general

APPLICABLE AIRWORTHINESS REQUIREMENTS

The applicable airworthiness requirements for approval of instruments and equipment required by this Part are the following:

- (a) Commission Regulation (EU) No 748/2012 for sailplanes registered in the EU; and
- (b) Airworthiness requirements of the state of registry for sailplanes registered outside the EU.

GM1 SPO.IDE.S.100(b) Instruments and equipment — general

REQUIRED INSTRUMENTS AND EQUIPMENT THAT DO NOT NEED TO BE APPROVED IN ACCORDANCE WITH THE APPLICABLE AIRWORTHINESS REQUIREMENTS

The functionality of non-installed instruments and equipment required by this Subpart and that do not need an equipment approval, as listed in SPO.IDE.S.100(b), should be checked against recognised industry standards appropriate to the intended purpose. The operator is responsible for ensuring the maintenance of these instruments and equipment.

GM1 SPO.IDE.S.100(c) Instruments and equipment — general

NOT REQUIRED INSTRUMENTS AND EQUIPMENT THAT DO NOT NEED TO BE APPROVED IN ACCORDANCE WITH THE APPLICABLE AIRWORTHINESS REQUIREMENTS, BUT ARE CARRIED ON A FLIGHT

- (a) The provision of this paragraph does not exempt any installed instrument or item of equipment from complying with the applicable airworthiness requirements. In this case, the installation should be approved as required in the applicable airworthiness requirements and should comply with the applicable Certification Specifications.
- (b) The failure of additional non-installed instruments or equipment not required by this Part or by the applicable airworthiness requirements or any applicable airspace requirements should not adversely affect the airworthiness and/or the safe operation of the sailplane. Examples may be portable electronic devices carried by crew members or task specialists.

SPO.IDE.S.105 Minimum equipment for flight

A flight shall not be commenced when any of the sailplane instruments, items of equipment or functions required for the intended flight are inoperative or missing, unless:

- (a) the sailplane is operated in accordance with the MEL, if established; or
- (b) the sailplane is subject to a permit to fly issued in accordance with the applicable airworthiness requirements.

SPO.IDE.S.115 Operations under VFR — flight and navigational instruments

- (a) Sailplanes operated under VFR by day shall be equipped with a means of measuring and displaying the following:
 - (1) in the case of powered sailplanes, magnetic heading,
 - (2) time in hours, minutes and seconds,
 - (3) pressure altitude, and
 - (4) indicated airspeed.
- (b) Sailplanes operating in conditions where the sailplane cannot be maintained in a desired attitude without reference to one or more additional instruments, shall be, in addition to (a), equipped with a means of measuring and displaying:
 - (1) vertical speed,
 - (2) attitude or turn and slip, and
 - (3) magnetic heading.

AMC1 SPO.IDE.S.115 & SPO.IDE.S.120 Operations under VFR & Cloud flying — flight and navigational instruments**INTEGRATED INSTRUMENTS**

- (a) Individual equipment requirements may be met by combinations of instruments or by integrated flight systems or by a combination of parameters on electronic displays. The information so available to each required pilot should not be less than that required in the applicable operational requirements, and the equivalent safety of the installation should be approved during type certification of the sailplane for the intended type of operation.
- (b) The means of measuring and indicating turn and slip and sailplane attitude may be met by combinations of instruments or by integrated flight director systems, provided that the safeguards against total failure, inherent in the three separate instruments, are retained.

AMC1 SPO.IDE.S.115(a)(1) & SPO.IDE.S.120(a) Operations under VFR & Cloud flying — flight and navigational instruments**MEANS OF MEASURING AND DISPLAYING MAGNETIC HEADING**

The means of measuring and displaying magnetic direction should be a magnetic compass or equivalent.

AMC1 SPO.IDE.S.115(a)(2) & SPO.IDE.S.120(b) Operations under VFR & Cloud flying — flight and navigational instruments

MEANS OF MEASURING AND DISPLAYING THE TIME

A means of measuring and displaying the time in hours, minutes and seconds may be a wrist watch capable of the same functions.

AMC1 SPO.IDE.S.115(a)(3) & SPO.IDE.S.120(c) Operations under VFR & Cloud flying — flight and navigational instruments

CALIBRATION OF THE MEANS FOR MEASURING AND DISPLAYING PRESSURE ALTITUDE

- (a) The instrument measuring and displaying pressure altitude should be of a sensitive type calibrated in feet (ft), with a sub-scale setting, calibrated in hectopascals/millibars, adjustable for any barometric pressure likely to be set during flight.
- (b) Calibration in metres (m) is also acceptable.

AMC1 SPO.IDE.S.115(a)(4) & SPO.IDE.S.120(d) Operations under VFR & Cloud flying — flight and navigational instruments

CALIBRATION OF THE INSTRUMENT INDICATING AIRSPEED

- (a) The instrument indicating airspeed should be calibrated in knots (kt).
- (b) Calibration in kilometres per hour (kph) or in miles per hour (mph) is also acceptable.

AMC1 SPO.IDE.S.115(B)(2) OPERATIONS UNDER VFR — FLIGHT AND NAVIGATIONAL INSTRUMENTS

SLIP INDICATION

The means of measuring and displaying slip may be a yaw string for operations under VFR.

GM1 SPO.IDE.S.115(b) Operations under VFR — flight and navigational instruments

CONDITIONS WHERE THE SAILPLANE CANNOT BE MAINTAINED IN A DESIRED ATTITUDE WITHOUT REFERENCE TO ONE OR MORE ADDITIONAL INSTRUMENTS

Sailplanes operating in conditions where the sailplane cannot be maintained in a desired attitude without reference to one or more additional instruments means a condition that is still under VFR (under VMC) though where there is no external reference such as the natural horizon or a coastline, that would allow the attitude to be maintained. Such conditions may occur over water, a desert or snow-covered areas where the colour of the surface cannot be distinguished from the colour of the sky and therefore no external reference is available. Cloud flying is not considered to be one of these conditions.

SPO.IDE.S.120 Cloud flying — flight and navigational instruments

Sailplanes performing cloud flying shall be equipped with a means of measuring and displaying:

- (a) magnetic heading,
- (b) time in hours, minutes and seconds,
- (c) pressure altitude,
- (d) indicated airspeed,
- (e) vertical speed, and
- (f) attitude or turn and slip.

SPO.IDE.S.125 Seats and restraint systems

- (a) Sailplanes shall be equipped with:
 - (1) a seat for each person on board; and
 - (2) a seat belt with upper torso restraint system for each seat according to the AFM.
- (b) A seat belt with upper torso restraint system shall have a single point release.

AMC1 SPO.IDE.S.125 Seats and restraint systems**UPPER TORSO RESTRAINT SYSTEM**

- (a) A seat belt with upper torso restraint system should have four anchorage points and should include shoulder straps (two anchorage points) and a seat belt (two anchorage points), which may be used independently.
- (b) A restraint system having five anchorage points is deemed to be compliant with the requirement for seat belt with upper torso restraint system with four anchorage points.

SPO.IDE.S.130 Supplemental oxygen

Sailplanes operated at pressure altitudes above 10 000 ft shall be equipped with an oxygen storage and dispensing apparatus carrying enough breathing oxygen to supply:

- (a) crew members for any period in excess of 30 minutes when the pressure altitude will be between 10 000 ft and 13 000 ft; and
- (b) all crew members and task specialists for any period that the pressure altitude will be above 13 000 ft.

SPO.IDE.S.135 Flight over water

The pilot-in-command of a sailplane operated over water shall determine the risks to survival of the occupants of the sailplane in the event of a ditching, based on which he/she shall determine the carriage of:

- (a) a life-jacket, or equivalent individual floatation device, for each person on board, that shall be worn or stowed in a position that is readily accessible from the seat of the person for whose use it is provided;
- (b) an emergency locator transmitter (ELT) or a personal locator beacon (PLB), carried by a crew member or a task specialist, capable of transmitting simultaneously on 121,5 MHz and 406 MHz; and
- (c) equipment for making distress signals, when operating a flight:
 - (1) over water beyond gliding distance from land; or
 - (2) where the take-off or approach path is so disposed over water that in the event of a mishap there would be a likelihood of ditching.

AMC1 SPO.IDE.S.135 Flight over water**MEANS OF ILLUMINATION FOR LIFE-JACKETS**

Each life-jacket or equivalent individual flotation device should be equipped with a means of electric illumination for the purpose of facilitating the location of persons.

RISK ASSESSMENT

- (a) When conducting the risk assessment, the pilot-in-command should base his/her decision, as far as is practicable, on the Implementing Rules and AMCs applicable to the operation of the sailplane.
- (b) The pilot-in-command should, for determining the risk, take the following operating environment and conditions into account:
 - (1) sea state;
 - (2) sea and air temperatures;
 - (3) the distance from land suitable for making an emergency landing; and
 - (4) the availability of search and rescue facilities.

GM1 SPO.IDE.S.135(a) Flight over water

SEAT CUSHIONS

Seat cushions are not considered to be flotation devices.

AMC1 SPO.IDE.S.135(b) Flight over water

BATTERIES

- (a) All batteries used in ELTs or PLBs should be replaced (or recharged, if the battery is rechargeable) when the equipment has been in use for more than 1 cumulative hour or in the following cases:
- (1) Batteries specifically designed for use in ELTs and having an airworthiness release certificate (EASA Form 1 or equivalent) should be replaced (or recharged, if the battery is rechargeable) before the end of their useful life in accordance with the maintenance instructions applicable to the ELT.
 - (2) Standard batteries manufactured in accordance with an industry standard and not having an airworthiness release certificate (EASA Form 1 or equivalent), when used in ELTs should be replaced (or recharged, if the battery is rechargeable) when 50 % of their useful life (or for rechargeable, 50 % of their useful life of charge), as established by the battery manufacturer, has expired.
 - (3) All batteries used in PLBs should be replaced (or recharged, if the battery is rechargeable) when 50 % of their useful life (or for rechargeable, 50 % of their useful life of charge), as established by the battery manufacturer, has expired.
 - (4) The battery useful life (or useful life of charge) criteria in (1),(2) and (3) do not apply to batteries (such as water-activated batteries) that are essentially unaffected during probable storage intervals.
- (b) The new expiry date for a replaced (or recharged) battery should be legibly marked on the outside of the equipment.

AMC2 SPO.IDE.S.135(b) Flight over water

TYPES OF ELT AND GENERAL TECHNICAL SPECIFICATIONS

- (a) The ELT required by this provision should be one of the following:
- (1) Automatic fixed (ELT(AF)). An automatically activated ELT that is permanently attached to an aircraft and is designed to aid SAR teams in locating the crash site.
 - (2) Automatic portable (ELT(AP)). An automatically activated ELT that is rigidly attached to an aircraft before a crash, but is readily removable from the aircraft after a crash. It functions as an ELT during the crash sequence. If the ELT does not employ an integral antenna, the aircraft-mounted antenna may be disconnected and an auxiliary antenna (stored on the ELT case) attached to the ELT. The ELT can be tethered to a survivor or a life-raft. This type of ELT is intended to aid SAR teams in locating the crash site or survivor(s).
 - (3) Automatic Deployable (ELT(AD)). An ELT that is rigidly attached to the aircraft before the crash and that is automatically ejected, deployed and activated by an impact, and, in some cases, also by hydrostatic sensors. Manual deployment is also provided. This type of ELT should float in water and is intended to aid SAR teams in locating the crash site.
 - (4) Survival ELT (ELT(S)). An ELT that is removable from an aircraft, stowed so as to facilitate its ready use in an emergency and manually activated by a survivor. An ELT(S) may be

activated manually or automatically (e.g. by water activation). It should be designed to be tethered to a life-raft or a survivor.

- (b) To minimise the possibility of damage in the event of crash impact, the automatic ELT should be rigidly fixed to the aircraft structure, as far aft as is practicable, with its antenna and connections arranged so as to maximise the probability of the signal being transmitted after a crash.
- (c) Any ELT carried should operate in accordance with the relevant provisions of ICAO Annex 10, Volume III and should be registered with the national agency responsible for initiating search and rescue or other nominated agency.

AMC3 SPO.IDE.S.135(b) Flight over water

PLB TECHNICAL SPECIFICATIONS

- (a) A personal locator beacon (PLB) should have a built-in GNSS receiver with a *cosmicheskaya sistyema poiska avariynich sudov* — search and rescue satellite-aided tracking (COSPAS-SARSAT) type approval number. However, devices with a COSPAS-SARSAT with a number belonging to series 700 are excluded as this series of numbers identifies the special-use beacons not meeting all the technical requirements and all the tests specified by COSPAS-SARSAT.
- (b) Any PLB carried should be registered with the national agency responsible for initiating search and rescue or other nominated agency.

AMC4 SPO.IDE.S.135(b) Flight over water.

BRIEFING ON PLB USE

When a PLB is carried by a task specialist, he/she should be briefed on its characteristics and use by the pilot-in-command before the flight.

GM1 SPO.IDE.S.135(b) Flight over water

TERMINOLOGY

- (a) An ELT is a generic term describing equipment that broadcasts distinctive signals on designated frequencies and, depending on application, may be activated by impact or may be manually activated.
- (b) A PLB is an emergency beacon other than an ELT that broadcasts distinctive signals on designated frequencies, is standalone, portable and is manually activated by the survivors.

SPO.IDE.S.140 Survival equipment

Sailplanes operated over areas in which search and rescue would be especially difficult shall be equipped with such signalling devices and life-saving equipment as appropriate to the area overflown.

AMC1 SPO.IDE.S.140 Survival equipment

GENERAL

Sailplanes operated across land areas in which search and rescue would be especially difficult should be equipped with the following:

- (a) signalling equipment to make the distress signals;
- (b) at least one ELT(S) or a PLB; and
- (c) additional survival equipment for the route to be flown taking account of the number of persons on board.

AMC2 SPO.IDE.S.140 Survival equipment

ADDITIONAL SURVIVAL EQUIPMENT

- (a) The following additional survival equipment should be carried when required:
 - (1) 500 ml of water;
 - (2) one knife;
 - (3) first-aid equipment; and
 - (4) one set of air/ground codes.
- (b) If any item of equipment contained in the above list is already carried on board the sailplane in accordance with another requirement, there is no need for this to be duplicated.

GM1 SPO.IDE.S.140 Survival equipment

SIGNALLING EQUIPMENT

The signalling equipment for making distress signals is described in ICAO Annex 2, Rules of the Air.

GM2 SPO.IDE.S.140 Survival equipment

AREAS IN WHICH SEARCH AND RESCUE WOULD BE ESPECIALLY DIFFICULT

The expression 'areas in which search and rescue would be especially difficult' should be interpreted, in this context, as meaning:

- (a) areas so designated by the authority responsible for managing search and rescue; or
- (b) areas that are largely uninhabited and where:
 - (1) the authority referred to in (a) published any information to confirm whether search and rescue would be or would not be especially difficult; and
 - (2) the authority referred to in (a). does not, as a matter of policy, designate areas as being especially difficult for search and rescue.

SPO.IDE.S.145 Radio communication equipment

- (a) Where required by the airspace being flown sailplanes shall be equipped with radio communication equipment capable of conducting two-way communication with those aeronautical stations or those frequencies to meet airspace requirements
- (b) Radio communication equipment, if required by (a), shall provide for communication on the aeronautical emergency frequency 121,5 MHz.

SPO.IDE.S.150 Navigation equipment

Sailplanes shall be equipped with any navigation equipment necessary to proceed in accordance with:

- (a) the ATS flight plan if applicable; and
- (b) the applicable airspace requirements.

GM1 SPO.IDE.S.150 Navigation equipment**APPLICABLE AIRSPACE REQUIREMENTS**

For sailplanes being operated under European air traffic control, the applicable airspace requirements include the Single European Sky legislation.

SPO.IDE.S.155 Transponder

When required by the airspace being flown, sailplanes shall be equipped with a secondary surveillance radar (SSR) transponder with all the required capabilities.

AMC1 SPO.IDE.S.155 Transponder

GENERAL

- (a) The SSR transponders of sailplanes being operated under European air traffic control should comply with any applicable Single European Sky legislation.
- (b) If the Single European Sky legislation is not applicable, the SSR transponders should operate in accordance with the relevant provisions of Volume IV of ICAO Annex 10.

SECTION 4
Balloons**SPO.IDE.B.100 Instruments and equipment — general**

- (a) Instruments and equipment required by this Subpart shall be approved in accordance with the applicable airworthiness requirements if they are:
- (1) used by the flight crew to determine the flight path;
 - (2) used to comply with SPO.IDE.B.145; or
 - (3) installed in the balloon.
- (b) The following items, when required by this Subpart, do not need an equipment approval:
- (1) independent portable light,
 - (2) an accurate time piece,
 - (3) first-aid kit, and
 - (4) survival and signalling equipment,
- (c) Instruments and equipment not required by this Subpart as well as any other equipment that is not required by other applicable Annexes, but is carried on a flight, shall comply with the following:
- (1) the information provided by these instruments, equipment or accessories shall not be used by the flight crew to comply with Annex I to Regulation (EC) No 216/2008; and
 - (2) the instruments and equipment shall not affect the airworthiness of the balloon, even in the case of failures or malfunction.
- (d) Instruments and equipment shall be readily operable or accessible from the station where the flight crew member that needs to use it is assigned.
- (e) All required emergency equipment shall be easily accessible for immediate use.

GM1 SPO.IDE.B.100(a) Instruments and equipment — general

APPLICABLE AIRWORTHINESS REQUIREMENTS

The applicable airworthiness requirements for approval of instruments and equipment required by this Part are the following:

- (a) Commission Regulation (EU) No 748/2012 for balloons registered in the EU; and
- (b) Airworthiness requirements of the state of registry for balloons registered outside the EU.

GM1 SPO.IDE.B.100(b) Instruments and equipment — general

REQUIRED INSTRUMENTS AND EQUIPMENT THAT DO NOT NEED TO BE APPROVED IN ACCORDANCE WITH THE APPLICABLE AIRWORTHINESS REQUIREMENTS

The functionality of non-installed instruments and equipment required by this Subpart and that do not need an equipment approval, as listed in SPO.IDE.B.100(b), should be checked against recognised industry standards appropriate to the intended purpose. The operator is responsible for ensuring the maintenance of these instruments and equipment.

GM1 SPO.IDE.B.100(c) Instruments and equipment — general

NOT REQUIRED INSTRUMENTS AND EQUIPMENT THAT DO NOT NEED TO BE APPROVED IN ACCORDANCE WITH THE APPLICABLE AIRWORTHINESS REQUIREMENTS, BUT ARE CARRIED ON A FLIGHT

- (a) The provision of this paragraph does not exempt any installed instrument or item of equipment from complying with the applicable airworthiness requirements. In this case, the installation should be approved as required in the applicable airworthiness requirements and should comply with the applicable Certification Specifications.
- (b) The failure of additional non-installed instruments or equipment not required by this Part or by the applicable airworthiness requirements or any applicable airspace requirements should not adversely affect the airworthiness and/or the safe operation of the balloon. Examples may be portable electronic devices carried by crew members or task specialists.

SPO.IDE.B.105 Minimum equipment for flight

A flight shall not be commenced when any of the balloon instruments, items of equipment or functions required for the intended flight are inoperative, unless:

- (a) the balloon is operated in accordance with the MEL, if established; or
- (b) the balloon is subject to a permit to fly issued in accordance with the applicable airworthiness requirements.

SPO.IDE.B.110 Operating lights

Balloons operated at night shall be equipped with:

- (a) anti-collision lights;
- (b) a means to provide adequate illumination for all instruments and equipment essential to the safe operation of the balloon;
- (c) an independent portable light.

AMC1 SPO.IDE.B.110 Operating lights**ANTI-COLLISION LIGHTS**

An acceptable means of compliance is the anti-collision light required for free manned balloons certified for VFR at night in accordance with CS-31HB/GB.

ILLUMINATION FOR INSTRUMENTS AND EQUIPMENT

A means to provide adequate illumination to instruments and equipment essential to the safe operation of the balloon may be an independent portable light.

SPO.IDE.B.115 Operations under VFR — flight and navigational instruments and associated equipment

Balloons operated under VFR by day shall be equipped with the following:

- (a) a means of displaying drift direction; and
- (b) a means of measuring and displaying:
 - (1) time in hours, minutes and seconds;
 - (2) vertical speed, if required by the AFM; and
 - (3) pressure altitude, if required by the AFM, if required by airspace requirements or when altitude needs to be controlled for the use of oxygen.

AMC1 SPO.IDE.B.115(a) Operations under VFR — flight and navigational instruments and associated equipment**MEANS OF DISPLAYING DRIFT DIRECTION**

The drift direction may be determined by using a map and reference to visual landmarks.

AMC1 SPO.IDE.B.115(b)(1) Operations under VFR — flight and navigational instruments and associated equipment**MEANS OF MEASURING AND DISPLAYING THE TIME**

A means of measuring and displaying the time in hours, minutes and seconds may be a wrist watch capable of the same functions.

GM1 SPO.IDE.B.115(b)(2) Operations under VFR — flight and navigational instruments**MEANS OF MEASURING AND DISPLAYING VERTICAL SPEED**

The necessity of a vertical speed indicator depends on the balloon design. Some envelope shapes have a high drag and will therefore not develop a high ascent/descent speed. Such balloons usually do not require a vertical speed indicator. More slender envelope shapes such as special shape balloons may have a significantly lower drag. Their ascent/descent speed is usually limited to a certain value so that controllability of the balloon is maintained. To be able to stay within this limitation of the AFM, a vertical speed indicator is required for such balloons.

GM1 SPO.IDE.B.115(b)(3) Operations under VFR — flight and navigational instruments and associated equipment**MEANS OF MEASURING AND DISPLAYING PRESSURE ALTITUDE**

A means of measuring and displaying pressure altitude is needed when required by ATC, or by Commission Implementing Regulation (EU) No 923/2012, or when altitude needs to be checked for flights where oxygen is used, or the limitations in the AFM require to limit altitude and/or rate of climb/descent.

SPO.IDE.B.120 First-aid kit

- (a) Balloons shall be equipped with a first-aid kit.
- (b) The first-aid kit shall be:
 - (1) readily accessible for use; and
 - (2) kept up-to-date.

AMC1 SPO.IDE.B.120 First-aid kit

CONTENT OF FIRST-AID KITS

- (a) First-aid kits should be equipped with appropriate and sufficient medications and instrumentation. However, these kits should be amended by the operator according to the characteristics of the operation (scope of operation, flight duration, number and demographics of passengers, etc.).
- (b) The following should be included in the FAKs:
 - (1) bandages (assorted sizes),
 - (2) burns dressings (large and small),
 - (3) wound dressings (large and small),
 - (4) adhesive dressings (assorted sizes),
 - (5) antiseptic wound cleaner,
 - (6) safety scissors, and
 - (7) disposable gloves.

AMC2 SPO.IDE.B.120 First-aid kit

MAINTENANCE OF FIRST-AID KIT

To be kept up to date, first-aid kits should be:

- (a) inspected periodically to confirm, to the extent possible, that contents are maintained in the condition necessary for their intended use;
- (b) replenished at regular intervals, in accordance with instructions contained on their labels, or as circumstances warrant; and
- (c) replenished after use in-flight at the first opportunity where replacement items are available.

SPO.IDE.B.121 Supplemental oxygen

Balloons operated at pressure altitudes above 10 000 ft shall be equipped with an oxygen storage and dispensing apparatus carrying enough breathing oxygen to supply:

- (a) crew members for any period in excess of 30 minutes when the pressure altitude will be between 10 000 ft and 13 000 ft; and
- (b) all crew members and task specialists for any period that the pressure altitude will be above 13 000 ft.

SPO.IDE.B.125 Hand fire extinguishers

Hot air balloons shall be equipped with at least one hand fire extinguisher if required by the applicable certification specifications.

AMC1 SPO.IDE.B.125 Hand fire extinguishers**CERTIFICATION SPECIFICATIONS**

The applicable Certification Specification for hot-air balloons should be CS-31HB or equivalent.

SPO.IDE.B.130 Flight over water

The pilot-in-command of a balloon operated over water shall determine the risks to survival of the occupants of the balloon in the event of a ditching, based on which he/she shall determine the carriage of:

- (a) a life-jacket for each person on board, that shall be worn or stowed in a position that is readily accessible from the station of the person for whose use it is provided;
- (b) an emergency locator transmitter (ELT) or a personal locator beacon (PLB), carried by a crew member or a task specialist, capable of transmitting simultaneously on 121,5 MHz and 406 MHz; and
- (c) equipment for making the distress signals.

AMC1 SPO.IDE.B.130 Flight over water

RISK ASSESSMENT

- (a) When conducting the risk assessment, the pilot-in-command should base his/her decision, as far as is practicable, on the Implementing Rules and AMCs applicable to the operation of the balloon.
- (b) The pilot-in-command should, for determining the risk, take the following operating environment and conditions into account:
 - (1) sea state;
 - (2) sea and air temperatures;
 - (3) the distance from land suitable for making an emergency landing; and
 - (4) the availability of search and rescue facilities.

AMC1 SPO.IDE.B.130(a) Flight over water

MEANS OF ILLUMINATION FOR LIFE-JACKETS

Each life-jacket or equivalent individual flotation device should be equipped with a means of electric illumination for the purpose of facilitating the location of persons.

AMC1 SPO.IDE.B.130(b) Flight over water

BATTERIES

- (a) All batteries used in ELTs or PLBs should be replaced (or recharged, if the battery is rechargeable) when the equipment has been in use for more than 1 cumulative hour or in the following cases:
 - (1) Batteries specifically designed for use in ELTs and having an airworthiness release certificate (EASA Form 1 or equivalent) should be replaced (or recharged, if the battery is rechargeable) before the end of their useful life in accordance with the maintenance instructions applicable to the ELT.
 - (2) Standard batteries manufactured in accordance with an industry standard and not having an airworthiness release certificate (EASA Form 1 or equivalent), when used in ELTs should be replaced (or recharged, if the battery is rechargeable) when 50 % of their useful life (or for rechargeable, 50 % of their useful life of charge), as established by the battery manufacturer, has expired.

- (3) All batteries used in PLBs should be replaced (or recharged, if the battery is rechargeable) when 50 % of their useful life (or for rechargeable, 50 % of their useful life of charge), as established by the battery manufacturer, has expired.
 - (4) The battery useful life (or useful life of charge) criteria in (1),(2) and (3) do not apply to batteries (such as water-activated batteries) that are essentially unaffected during probable storage intervals.
- (b) The new expiry date for a replaced (or recharged) battery should be legibly marked on the outside of the equipment.

AMC2 SPO.IDE.B.130(b) Flight over water

TYPES OF ELT AND GENERAL TECHNICAL SPECIFICATIONS

- (a) The ELT required by this provision should be one of the following:
- (1) Automatic fixed (ELT(AF)). An automatically activated ELT that is permanently attached to an aircraft and is designed to aid SAR teams in locating the crash site.
 - (2) Automatic portable (ELT(AP)). An automatically activated ELT that is rigidly attached to an aircraft before a crash, but is readily removable from the aircraft after a crash. It functions as an ELT during the crash sequence. If the ELT does not employ an integral antenna, the aircraft-mounted antenna may be disconnected and an auxiliary antenna (stored on the ELT case) attached to the ELT. The ELT can be tethered to a survivor or a life-raft. This type of ELT is intended to aid SAR teams in locating the crash site or survivor(s).
 - (3) Automatic deployable (ELT(AD)). An ELT that is rigidly attached to the aircraft before the crash and which is automatically ejected, deployed and activated by an impact, and, in some cases, also by hydrostatic sensors. Manual deployment is also provided. This type of ELT should float in water and is intended to aid SAR teams in locating the crash site.
 - (4) Survival ELT (ELT(S)). An ELT that is removable from an aircraft, stowed so as to facilitate its ready use in an emergency and manually activated by a survivor. An ELT(S) may be activated manually or automatically (e.g. by water activation). It should be designed to be tethered to a life-raft or a survivor.
- (b) To minimise the possibility of damage in the event of crash impact, the automatic ELT should be rigidly fixed to the aircraft structure, as far aft as is practicable, with its antenna and connections arranged so as to maximise the probability of the signal being transmitted after a crash.
- (c) Any ELT carried should operate in accordance with the relevant provisions of ICAO Annex 10, Volume III and should be registered with the national agency responsible for initiating search and rescue or other nominated agency.

AMC3 SPO.IDE.B.130(b) Flight over water

PLB TECHNICAL SPECIFICATIONS

- (a) A personal locator beacon (PLB) should have a built-in GNSS receiver with a *cosmicheskaya sistyema poiska avarynich sudov* — search and rescue satellite-aided tracking (COSPAS-SARSAT) type approval number. However, devices with a COSPAS-SARSAT with a number belonging to series 700 are excluded as this series of numbers identifies the special-use beacons not meeting all the technical requirements and all the tests specified by COSPAS-SARSAT.
- (b) Any PLB carried should be registered with the national agency responsible for initiating search and rescue or other nominated agency.

AMC4 SPO.IDE.B.130(b) Flight over water

BRIEFING ON PLB USE

When a PLB is carried by a task specialist, he/she should be briefed on its characteristics and use by the pilot-in-command before the flight.

GM1 SPO.IDE.B.130(b) Flight over water

TERMINOLOGY

- (a) An ELT is a generic term describing equipment that broadcasts distinctive signals on designated frequencies and, depending on application, may be activated by impact or may be manually activated.
- (b) A PLB is an emergency beacon other than an ELT that broadcasts distinctive signals on designated frequencies, is standalone, portable and is manually activated by the survivors.

GM1 SPO.IDE.B.130(c) Flight over water

SIGNALLING EQUIPMENT

The signalling equipment for making distress signals is described in ICAO Annex 2, Rules of the Air.

SPO.IDE.B.135 Survival equipment

Balloons operated over areas in which search and rescue would be especially difficult shall be equipped with such signalling devices and life-saving equipment as appropriate to the area overflown.

AMC1 SPO.IDE.B.135 Survival equipment

GENERAL

Balloons operated across land areas in which search and rescue would be especially difficult should be equipped with the following:

- (a) signalling equipment to make the distress signals;
- (b) at least one ELT(S) or a PLB; and
- (c) additional survival equipment for the route to be flown taking account of the number of persons on board.

AMC2 SPO.IDE.B.135 Survival equipment

ADDITIONAL SURVIVAL EQUIPMENT

- (a) The following additional survival equipment should be carried when required:
 - (1) 500 ml of water for each four, or fraction of four, persons on board;
 - (2) one knife;
 - (3) first-aid equipment; and
 - (4) one set of air/ground codes.
- (b) If any item of equipment contained in the above list is already carried on board the balloon in accordance with another requirement, there is no need for this to be duplicated.

GM2 SPO.IDE.B.135 Survival equipment

AREAS IN WHICH SEARCH AND RESCUE WOULD BE ESPECIALLY DIFFICULT

The expression 'areas in which search and rescue would be especially difficult' should be interpreted, in this context, as meaning:

- (a) areas so designated by the authority responsible for managing search and rescue; or
- (b) areas that are largely uninhabited and where:
 - (1) the authority referred to in (a) has not published any information to confirm whether search and rescue would be or would not be especially difficult; and
 - (2) the authority referred to in (a) does not, as a matter of policy, designate areas as being especially difficult for search and rescue.

SPO.IDE.B.140 Miscellaneous equipment

Balloons shall be equipped with protective gloves for each crew member.

(a) Hot-air balloons shall be equipped with:

- (1) an alternative source of ignition;
- (2) a means of measuring and indicating fuel quantity;
- (3) a fire blanket or fire resistant cover; and
- (4) a drop line of at least 25 metres (m) in length.

(b) Gas balloons shall be equipped with:

- (1) a knife; and
- (2) a drop line of at least 20 m in length made of natural fibre or electrostatic conductive material.

AMC1 SPO.IDE.B.140(a)(3) Miscellaneous equipment**FIRE BLANKET**

A fire blanket should comply with EN 1869 or equivalent. The size should be at least 1.5 m x 2 m. Smaller sizes are not recommended as they cannot sufficiently cover the source of developing propane fire.

AMC1 SPO.IDE.B.140 (b)(1) Miscellaneous equipment**KNIFE**

The knife, hook knife or equivalent, should be capable of cutting any control line or handling rope that is accessible to the pilot-in-command or a crew member from the basket.

SPO.IDE.B.145 Radio communication equipment

- (a) Where required by the airspace being flown balloons shall be equipped with radio communication equipment capable of conducting two-way communication with those aeronautical stations or those frequencies to meet airspace requirements.
- (b) Radio communication equipment, if required by (a), shall provide for communication on the aeronautical emergency frequency 121,5 MHz.

GM1 SPO.IDE.B.145 Radio communication equipment**APPLICABLE AIRSPACE REQUIREMENTS**

For balloons being operated under European air traffic control, the applicable airspace requirements include the Single European Sky legislation.

SPO.IDE.B.150 Transponder

When required by the airspace being flown, balloons shall be equipped with a secondary surveillance radar (SSR) transponder with all the required capabilities.

AMC1 SPO.IDE.B.150 Transponder

GENERAL

- (a) The SSR transponders of balloons being operated under European air traffic control should comply with any applicable Single European Sky legislation.
- (b) If the Single European Sky legislation is not applicable, the SSR transponders should operate in accordance with the relevant provisions of Volume IV of ICAO Annex 10.

SUBPART E: SPECIFIC REQUIREMENTS

SECTION 1 *Helicopter external sling load operations (HESLO)*

SPO.SPEC.HESLO.100 Standard operating procedures

The standard operating procedures for HESLO shall specify:

- (a) the equipment to be carried, including its operating limitations and appropriate entries in the MEL, as applicable;
- (b) crew composition and experience requirements of crew members and task specialists;
- (c) the relevant training for crew members and task specialists to perform their task and the qualification and nomination of persons providing such training to the crew members and task specialists;
- (d) responsibilities and duties of crew members and task specialists;
- (e) performance criteria necessary to be met to conduct HESLO operations;
- (f) normal, abnormal and emergency procedures.

AMC1 SPO.SPEC.HESLO.100 Standard operating procedures

STANDARD OPERATING PROCEDURES

- (a) Before conducting any HESLO, the operator should develop its SOPs taking into account the elements below.
- (b) Nature and complexity of the activity
 - (1) Nature of the activity and exposure:
Helicopter flights for the purpose of transporting external loads by different means, e.g. under slung, external pods or racks. These operations are usually performed as low level flights.
 - (2) Complexity of the activity:
The complexity of the activity varies with the size and the shape of the load, the length of the rope and characteristics of the pick-up and drop-off zones, the time per load cycle, etc.

Table 1: HESLO types

HESLO 1:	short line, 20 metres (m) or less
HESLO 2:	long line, more than 20 m
HESLO 3:	logging
HESLO 4:	construction, wire stringing, cable laying
HESLO 5:	heavy lift (mass of external load 1 500 kg or above)

(3) Operational environment and geographical area:

HESLO may be performed over any geographical area. Special attention should be given to:

- (i) hostile and congested;
- (ii) mountains;
- (iii) sea;
- (iv) jungle;
- (v) desert; and
- (vi) polar;
- (vii) lakes and river canyons; and
- (viii) environmentally sensitive areas (e.g. national parks, noise sensitive areas).

(c) Equipment

(1) The helicopter may be equipped with:

- (i) additional mirror(s);
- (ii) a bubble window;
- (iii) supplementary hook(s) or multi-hook device(s); and
- (iv) load data recorder (lifts, weights, torques, power, forces, shocks and electrical activities).

(2) Non-assisted vertical reference operations may require additional engine monitoring in the pilot line of vision or an audio warning system.

(3) All additional equipment used, e.g. ropes, cables, mechanical hooks, swivel hooks, nets, buckets, chainsaws, baskets, containers, should be manufactured according to applicable rules or recognised standards. The operator should be responsible for maintaining the serviceability of this equipment.

(4) Adequate radio communication equipment (e.g. VHF, UHF, FM) should be installed and serviceable in the helicopter for co-ordination with the task specialists involved in the operation.

(5) Task specialists involved in the operation should be equipped with hand-held communication equipment, protective helmets with integrated earphones and microphones.

(d) Crew members

(1) Crew composition:

- (i) The minimum flight crew as stated in the approved AFM. For operational or training purposes, an additional crew member may assist the pilot-in-command (PIC) in a single-pilot operation.
- (ii) For safety and/or operational purposes, task specialists should be instructed by the operator to fulfil specified tasks (e.g. to establish vertical reference).

(2) Pilot initial training

Before acting as PIC, the pilot should demonstrate to the operator that he/she has the required skills and knowledge.

- (i) Theoretical knowledge:
 - (A) content of the operations manual (OM) including the relevant SOP;
 - (B) AFM (limitations, emergencies, etc.);
 - (C) procedures for certain operations (short line, long line, construction, wire stringing or cable laying flying techniques, as required for the operation);
 - (D) load and site preparation including load rigging techniques and external load procedures;
 - (E) special equipment used in the operation;
 - (F) training in human factor principles; and
 - (G) hazards and dangers.
- (3) Pilot experience
 - (i) For operations with a maximum external load mass of less than 1 500 kg, the PIC should have at least the following experience:

Prior to commencing training:

 - (A) 300 hours helicopter flight experience as PIC, which should be increased to 500 hours experience as PIC for mountain operations; and
 - (B) 10 hours flight experience on the helicopter type;

Before acting as PIC:

 - (C) 30 hours on the helicopter type, performing HESLO 1 and 2 operations. Where a pilot has accomplished 50 hours in HESLO 1 and 2 operations, the 30 hours experience on the helicopter type may be reduced to 15 hours.
 - (ii) For operations with a maximum external load mass of 1 500 kg and above, the pilot-in-command should have at least the following experience:

Prior to commencing training:

 - (A) 1 000 hours helicopter flight experience as PIC, which should be increased to 1 500 hours experience as PIC for mountain operations ;
 - (B) 10 hours flight experience on the helicopter type;

Before acting as PIC:

 - (C) 30 hours on the helicopter type, performing HESLO 1 and 2 operations. Where a pilot has accomplished 50 hours in HESLO 1 and 2 operations, the 30 hours experience on the helicopter type may be reduced to 15 hours.
 - (D) At least 20 hours gained in an operational environment similar to environment of intended operation (desert, sea, jungle, etc.).
 - (iii) For HESLO 3 only, additionally to experience (i) or (ii):

Prior to commencing training:

 - (A) At least qualified as PIC for HESLO 1 type;
 - (B) Minimum 500 HESLO cycles.
 - (iv) For HESLO 4 only, additionally to (i) or (ii):

Prior to commencing training:

- (A) At least qualified as PIC for HESLO 2 or HESLO 3;
 - (B) Minimum 1000 flight hours on helicopters; and
 - (C) Minimum 3000 HESLO cycles.
- (4) Pilot recurrent training and checking at least every two years:
- (i) review of the load rigging techniques;
 - (ii) external load procedures;
 - (iii) review of the applicable flying techniques; and
 - (iv) review of human factor principles.
 - (v) A pilot who has performed 20 hours of relevant HESLO within the past 12 months may not need any further flight training other than in accordance with Part-FCL.
- (e) Task specialists
- Before acting as task specialist, he/she should demonstrate to the operator that he/she has been trained appropriately and has the required skill and knowledge.
- (1) Initial training
- (i) The initial training of task specialists should include at least:
 - (A) behaviour in a rotor turning environment and training in ground safety and emergency procedures;
 - (B) procedures including load rigging, usage and conservation (replacement) of LLD;
 - (C) helicopter marshalling signals;
 - (D) radio communication;
 - (E) selection and preparation of pick-up and drop-off sites, dangers on working places (downwash, loose goods, third people);
 - (F) handling and safety of third party;
 - (G) relevant training for the helicopter type;
 - (H) duties and responsibilities as described in the appropriate manual;
 - (I) perception and classification of flight obstacles (none, critical, danger), measures for safety; and
 - (J) human factor principles.
 - (ii) The individual safety equipment appropriate to the operational environment and complexity of the activity should be described in the appropriate manual.
- (2) Recurrent training
- (i) The annual recurrent training should include the items listed in the initial training as described in (e)(1) above.
 - (ii) The operator should establish a formal qualification list for each individual task specialist.
 - (iii) The operator should establish a system of record keeping that allows adequate storage and reliable traceability of:
 - (A) the initial and recurrent training;

(B) Qualifications (qualification list).

(3) Briefing of task specialists

Briefings on the organisation and coordination between flight crew and task specialists involved in the operation should take place prior to each operation. These briefings should include at least the following:

- (i) location and size of pick-up and drop-off site, operating altitude;
- (ii) location of refuelling site and procedures to be applied; and
- (iii) load sequence, danger areas, performance and limitations, emergency procedures.

(4) Responsibility of task specialists operating on the ground:

- (i) Task specialists operating on the ground are responsible for the safe organisation of the ground operation, including:
 - (A) adequate selection and preparation of the pick-up and drop-off points and load rigging;
 - (B) appropriate communication and assistance to the flight crew and other task specialists; and
 - (C) access restriction on the pick-up and drop-off site.
- (ii) If more than one task specialist is required for a task, one should be nominated as leading the activities. He/she should act as main link between flight crew and other task specialist(s) involved in the operation and is responsible for:
 - (A) task specialist co-ordination and activities on the ground; and
 - (B) the safety of the working area (loading and fuelling).

(f) HESLO instructor

The HESLO instructor should be assigned by the operator on the basis of the following:

- (1) the HESLO instructor for pilots should be suitably qualified as determined by the operator and have a minimum experience of 500 hours HESLO operations in the appropriate HESLO level on which instruction is to be provided as well as experience in instructing according to the flight instructor or type rating instructor training;
- (2) the HESLO instructor for task specialists should be suitably qualified as determined by the operator and have at least 2 years of experience in HESLO operations.

(g) Performance

(1) Power margins for HESLO operations:

(i) HESLO 1 and 2

The mass of the helicopter should not exceed the maximum mass specified in accordance with SPO.POL.146(c)(1) at the pick-up or drop-off site, whichever is higher, as stated in the appropriate manual.

(ii) HESLO 3, 4 and 5

The mass of the helicopter should not exceed the maximum mass specified in accordance with SPO.POL.146(c)(1) at the pick-up or drop-off site, whichever is higher, as stated in the appropriate manual, and in case of construction (montage) operations, reduced by 10% of the mass of the sling load capacity.

(h) Normal procedures

(1) Operating procedures:

HESLO should be performed in accordance with the appropriate manual and appropriate operating procedures. These procedures should include, for each type of operation:

- (i) crew individual safety equipment (e.g. helmet, fire retardant suits);
- (ii) crew responsibilities;
- (iii) crew coordination and communication;
- (iv) selection and size of pick-up and drop-off sites;
- (v) selection of flight routes;
- (vi) fuel management in the air and on the ground;
- (vii) task management; and
- (viii) third party risk management.

(2) Ground procedures:

The operator should specify appropriate procedures, including:

- (i) use of ground equipment;
- (ii) load rigging;
- (iii) size and weight assessment of loads;
- (iv) attachment of suitably prepared loads to the helicopter;
- (v) two-way radio communication procedures;
- (vi) selection of suitable pick-up and drop-off sites;
- (vii) safety instructions for task specialists operating on the ground;
- (viii) helicopter performances information;
- (ix) fuel management on the ground;
- (x) responsibility, organisation and task management of other personnel on the ground involved in the operation;
- (xi) third party risk management; and
- (xii) environmental protection.

(i) Emergency procedures

(1) Operating procedures for the flight crew:

In addition to the emergency procedures published in the AFM or OM, the operator should ensure that the flight crew:

- (i) is familiar with the appropriate emergency procedures;
- (ii) has appropriate knowledge of the emergency procedures for personnel on the ground involved in the operation; and
- (iii) reports emergencies as specified in the AFM or OM.

(2) Ground procedures:

The operator should ensure that the task specialist on the ground involved in the operation:

- (i) is familiar with the appropriate emergency procedures;
- (ii) has appropriate knowledge of the flight crew emergency procedures;
- (iii) reports emergencies as specified in the AFM or OM; and
- (iv) prevents, as far as possible, environmental pollution.

(j) Ground equipment

The operator should specify the use of ground equipment, such as fuel trucks, cables, strops etc. in the AFM or OM, including at least:

- (1) minimum size of the operating site;
- (2) surface condition;
- (3) positioning of ground equipment on the operating site;
- (4) fuel handling;
- (5) environment protection plan; and
- (6) location and use of fire suppression equipment.

GM1 SPO.SPEC.HESLO.100 Standard operating procedures

PILOT INITIAL TRAINING

The table below specifies minimum standards before starting the practical instructions.

Table 1: Training minimum standards

HESLO 1	<ul style="list-style-type: none"> – CPL(H) or ATPL(H) – PPL(H) only for non-commercial operations – Minimum 300 hours PIC (H) – Minimum 10 hours PIC on type – Type rating completed – HESLO ground instruction completed – Task specialist syllabus reviewed
HESLO 2	<ul style="list-style-type: none"> – CPL(H) or ATPL(H) – PPL(H) only for non-commercial operations – HESLO level 1 completed – Type rating completed – Minimum 10 hours PIC on type – HESLO 2 ground instruction completed – Task specialist syllabus reviewed – Minimum 500 HESLO1 cycles
HESLO 2 Conversion	<ul style="list-style-type: none"> – CPL(H) or ATPL(H) – PPL(H) only for non-commercial operations – HESLO level 3 completed

	<ul style="list-style-type: none"> – Type rating completed – Minimum 10 hours PIC on type – HESLO 2 ground instruction completed – Task specialist syllabus reviewed
HESLO 3	<ul style="list-style-type: none"> – CPL(H) or ATPL(H) – PPL(H) only for non-commercial operations – HESLO level 1 completed to 20m – Min. 500 HESLO cycles – Type rating completed – Minimum 10 hours PIC on type – HESLO 3 ground instruction completed – Task specialist syllabus reviewed – Practical Task specialist training for logging
HESLO 3 Conversion	<ul style="list-style-type: none"> – CPL(H) or ATPL(H) – PPL(H) only for non-commercial operations – HESLO level 2 completed – Minimum 500 HESLO cycles – Type rating completed – Minimum 10 hours PIC on type – HESLO 3 ground instruction completed – Task specialist syllabus reviewed – Practical Task specialist training for logging
HESLO 4	<ul style="list-style-type: none"> – CPL(H) or ATPL(H) – PPL(H) only for non-commercial operations – Minimum 1 000 hours (H) – HESLO level 2 or 3 completed – Minimum 3 000 HESLO cycles – Type rating completed – Minimum 10 hours PIC on type – HESLO 4 ground instruction completed – Practical load preparation training
HESLO 5	<ul style="list-style-type: none"> – CPL(H) or ATPL(H) – 1 000 h PIC (H)/ 1 500 h PIC (H) for mountain operations – Type rating completed – Appropriate HESLO level completed – HESLO 5 ground instruction completed – Task specialist syllabus reviewed – Practical load preparation training completed

SPO.SPEC.HESLO.105 Specific HESLO equipment

The helicopter shall be equipped with at least:

- (a) one cargo safety mirror or alternative means to see the hook(s)/load; and
- (b) one load meter, unless there is another method of determining the weight of the load.

SPO.SPEC.HESLO.110 Transportation of dangerous goods

The operator transporting dangerous goods to or from unmanned sites or remote locations shall apply to the competent authority for an exemption from the provisions of the Technical Instructions if they intend not to comply with the requirements of those Instructions.

SECTION 2
Human external cargo operations (HEC)

SPO.SPEC.HEC.100 Standard operating procedures

The standard operating procedures for HEC shall specify:

- (a) the equipment to be carried, including its operating limitations and appropriate entries in the MEL, as applicable;
- (b) crew composition and experience requirements of crew members and task specialists;
- (c) the relevant training for crew members and task specialists to perform their task and the qualification and nomination of persons providing such training to the crew members and task specialists;
- (d) responsibilities and duties of crew members and task specialists;
- (e) performance criteria necessary to be met to conduct HEC operations;
- (f) normal, abnormal and emergency procedures.

AMC1 SPO.SPEC.HEC.100 Standard operating procedures

STANDARD OPERATING PROCEDURES

- (a) Before conducting any HEC operations, the operator should develop its SOPs taking into account the elements below.
- (b) Nature and complexity of the activity
 - (1) Nature of the activity and exposure:
 - (i) Helicopter operations for the purpose of transporting humans as external loads from/to aerodromes and/or operating sites. The operations are performed as low level flights.
 - (ii) The operator should only carry task specialists to a site if the level of danger would be too high for them to go there with another mean of transport or where no other means of transport exists. HEC flights should always be conducted with the minimum time of exposure for the task specialists.
 - (2) Complexity of the activity:
 - (i) The complexity of the activity varies with the length of the rope and characteristics of the pick-up and drop-off zones, etc.

Table 1: HEC levels

HEC 1:	Sling less or equal to 25 m Altitude is less or equal to 3 000 m
HEC 2:	Sling less or equal to 50 m Altitude is less or equal to 3 500 m

HEC 3:	Cable length is unrestricted Altitude is unrestricted
--------	--

(3) Operational environment and geographical area:

HEC may be performed over any geographical area. Special attention should be given to:

- (i) hostile congested and non-congested environment;
- (ii) mountains;
- (iii) sea;
- (iv) jungle;
- (v) desert;
- (vi) arctic;
- (vii) lakes and river canyons; and
- (viii) environmentally sensitive areas (e.g. national parks, noise sensitive areas).

(c) Equipment

(1) The helicopter may be equipped with:

- (i) additional mirror(s);
- (ii) a bubble window;
- (iii) supplementary hook(s) or multi-hook device(s); and
- (iv) load data recorder (lifts, weights, torques, power, forces, shocks and electrical activities).

(2) Non-assisted vertical reference operations should require additional engine monitoring in the pilot line of vision or an audio warning system.

(3) All additional equipment used, e.g. ropes, cables, mechanical hooks, swivel hooks, nets, buckets, baskets, containers, should be manufactured according to officially recognised standards. The operator is responsible for maintaining the serviceability of this equipment.

(4) Adequate radio communication equipment (e.g. VHF, UHF, FM) should be installed in the helicopter for co-ordination with the task specialist involved in the operation.

(5) Task specialists involved in the operation should be equipped with hand-held communication equipment, protective helmets with integrated earphones and microphones as well as personal protective equipment.

(d) Crew members

(1) Crew composition:

- (i) The minimum flight crew is stated in the approved AFM. For operational or training purposes, an additional qualified crew member may assist the PIC in a single-pilot operation.
- (ii) For safety and/or operational purposes, a task specialist may be required by the operator to fulfil the task (e.g. to establish vertical reference or to operate the release safety device for the belly rope).

(2) Pilot initial training:

Before acting as PIC, the pilot should demonstrate to the operator that he/she has the required skills and knowledge, as follows:

(i) Theoretical knowledge:

- (A) load rigging techniques;
- (B) external load procedures;
- (C) site organisation and safety measures;
- (D) short line, long line, construction, wire stringing or cable laying flying techniques, as required for the operation.

(ii) Pilot experience prior to commencing the training:

- (A) 1 000 hours helicopter flight experience as PIC, of which 500h should be gained in mountainous areas for training in mountain operations;
- (B) 10 hours flight experience on the helicopter type;
- (C) type rating completed;
- (D) HESLO type 1 or 2 completed;
- (E) relevant experience in the field of operation;
- (G) training in human factor principles; and
- (F) ground instruction completed (marshaller syllabus).

(3) Pilot recurrent training and checking at least every two years:

- (i) review of the sling technique;
- (ii) external load procedures;
- (iii) training in human factor principles; and
- (iv) review of the applicable flying techniques.

(4) Conditions of HEC instruction:

(i) Maximum sling length according to the level applicable:

- (A) 1 task specialist (with radio) at pickup point;
- (B) 1 task specialist (with radio) at drop off point/on the line;
- (C) helicopter fitted with cargo mirror/bubble window;
- (D) flight instruction DC/: Cycles DC/minimum 10 cycles which of 5 Human Cargo Sling; and
- (E) flight instruction solo with onsite supervision/Cycles solo/minimum 10 cycles.

(ii) HEC instructor:

The HEC instructor should be assigned by the operator on the basis of the following:

- (A) the HEC instructor for pilots should hold or have held flight instructor rating and should have a minimum experience of 100 cycles in HEC operations in the appropriate HEC level on which instruction is to be provided;

- (B) the HEC instructor for task specialists should be suitably qualified as determined by the operator and have at least 2 years of experience in HEC operations as a task specialist.

(e) Task specialists

Before acting as task specialists, they should demonstrate to the operator that they have been appropriately trained and have the required skills and knowledge including training on human factor principles.

(1) Task specialists should be trained to operate the system including:

- (i) montage and removal of system; and
- (ii) normal procedure.

(2) Briefings

Briefings on the organisation and coordination between flight crew and task specialist involved in the operation should take place prior to each operation. These briefings should include at least the following:

- (i) location and size of pick-up and drop-off site, operating altitude;
- (ii) location of refuelling site and procedures to be applied; and
- (iii) load sequence, danger areas, performance and limitations, emergency procedures.

(3) Recurrent training

- (i) The annual recurrent training should include the items listed in the initial training as described in (e)(1) above.
- (ii) The operator should establish a formal qualification list for each individual task specialist.
- (iii) The operator should establish a system of record keeping that allows adequate storage and reliable traceability of:
 - (A) the initial and recurrent training;
 - (B) qualifications (qualification list).

(f) Performance

HEC should be performed with the following power margins: the mass of the helicopter should not exceed the maximum mass specified in accordance with SPO.POL.146(c)(1).

(g) Normal procedures

(1) Operating procedures:

HEC should be performed in accordance with the AFM. Operating procedures should include, for each type of operation:

- (i) crew individual safety equipment (e.g. helmet, fire retardant suits);
- (ii) crew responsibilities;
- (iii) crew coordination and communication;
- (iv) selection and size of pick-up and drop-off sites;
- (v) selection of flight routes;
- (vi) fuel management in the air and on the ground;

- (vii) task management; and
 - (viii) third party risk management.
- (2) Ground procedures:
- The operator should specify appropriate procedures, including:
- (i) use of ground equipment;
 - (ii) load rigging;
 - (iii) size and weight assessment of loads;
 - (iv) attachment of suitably prepared loads to the helicopter;
 - (v) two-way radio communication procedures;
 - (vi) selection of suitable pick-up and drop-off sites;
 - (vii) safety instructions for ground task specialists or other persons required for the safe conduct of the operation;
 - (viii) helicopter performances information;
 - (ix) fuel management on the ground;
 - (x) responsibility and organisation of the personnel on the ground involved in the operation;
 - (xi) task management of personnel on the ground involved in the operation;
 - (xii) third party risk management; and
 - (xiii) environmental protection.
- (h) Emergency procedures
- (1) Operating procedures:
- In addition to the emergency procedures published in the AFM or OM, the operator should ensure that the flight crew:
- (i) is familiar with the appropriate emergency procedures;
 - (ii) has appropriate knowledge of the emergency procedures for personnel on the ground involved in the operation; and
 - (iii) reports emergencies as specified in the AFM or OM.
- (2) Ground procedures:
- The operator should ensure that the task specialist on the ground involved in the operation:
- (i) is familiar with the appropriate emergency procedures;
 - (ii) has appropriate knowledge of the emergency procedures for personnel on the ground involved in the operation;
 - (iii) reports emergencies as specified in the AFM or OM; and
 - (iv) prevents, as far as possible, environmental pollution.

SPO.SPEC.HEC.105 Specific HEC equipment

- (a) The helicopter shall be equipped with:
- (1) hoist operations equipment or cargo hook;
 - (2) one cargo safety mirror or alternative means to see the hook; and
 - (3) one load meter, unless there is another method of determining the weight of the load.
- (b) The installation of all hoist and cargo hook equipment and any subsequent modifications shall have an airworthiness approval appropriate to the intended function.

AMC1 SPO.SPEC.HEC.105(b) Specific HEC equipment

AIRWORTHINESS APPROVAL FOR HEC EQUIPMENT

- (a) Hoist or cargo hook installations that have been certificated according to any of the following standards should be considered to satisfy the airworthiness criteria for HEC operations:
- (1) CS 27.865 or CS 29.865;
 - (2) JAR 27 Amendment 2 (27.865) or JAR 29 Amendment 2 (29.865) or later;
 - (3) FAR 27 Amendment 36 (27.865) or later — including compliance with CS 27.865(c)(6); or
 - (4) FAR 29 Amendment 43 (29.865) or later.
- (b) Hoist or cargo hook installations that have been certified prior to the issuance of the airworthiness criteria for HEC as defined in (a) may be considered as eligible for HEC provided that following a risk assessment either:
- (1) the service history of the hoist or cargo hook installation is found satisfactory to the competent authority; or
 - (2) for hoist or cargo hook installations with an unsatisfactory service history, additional substantiation to allow acceptance by the competent authority should be provided by the hoist or cargo hook installation certificate holder (type certificate (TC) or supplemental type certificate (STC)) on the basis of the following requirements:
 - (i) The hoist or cargo hook installation should withstand a force equal to a limit static load factor of 3.5, or some lower load factor, not less than 2.5, demonstrated to be the maximum load factor expected during hoist operations, multiplied by the maximum authorised external load.
 - (ii) The reliability of the primary and back up quick release systems at helicopter level should be established and failure mode and effect analysis at equipment level should be available. The assessment of the design of the primary and back up quick release systems should consider any failure that could be induced by a failure mode of any other electrical or mechanical rotorcraft system.
 - (iii) The appropriate manual should contain one-engine-inoperative (OEI) hover performance data or single engine failures procedures for the weights, altitudes, and temperatures throughout the flight envelope for which hoist or cargo hook operations are accepted.
 - (iv) Information concerning the inspection intervals and retirement life of the hoist or cargo hook cable should be provided in the instructions for continued airworthiness.

SECTION 3
Parachute operations (PAR)

SPO.SPEC.PAR.100 Standard operating procedures

The standard operating procedures for PAR shall specify:

- (a) the equipment to be carried, including its operating limitations and appropriate entries in the MEL, as applicable;
- (b) crew composition and experience requirements of crew members and task specialists;
- (c) the relevant training for crew members and task specialists to perform their task and the qualification and nomination of persons providing such training to the crew members and task specialists;
- (d) responsibilities and duties of crew members and task specialists;
- (e) performance criteria necessary to be met to conduct parachute operations;
- (f) normal, abnormal and emergency procedures.

SPO.SPEC.PAR.105 Carriage of crew members and task specialists

The requirement for task specialist's responsibilities as laid down in SPO.GEN.106(c) shall not be applicable for task specialists performing parachute jumping.

SPO.SPEC.PAR.110 Seats

Notwithstanding SPO.IDE.A.160(a) and SPO.IDE.H.160(a)(1), the floor of the aircraft may be used as a seat, provided means are available for the task specialist to hold or strap on.

SPO.SPEC.PAR.115 Supplemental oxygen

Notwithstanding SPO.OP.195(a), the requirement to use supplemental oxygen shall not be applicable for crew members other than the pilot-in-command and for task specialists carrying out duties essential to the specialised task, whenever the cabin altitude:

- (a) exceeds 13 000 ft, for a period of not more than 6 minutes.
- (b) exceeds 15 000 ft, for a period of not more than 3 minutes.

SPO.SPEC.PAR.120 Flight over water

When carrying more than 6 persons, the pilot-in-command of a balloon operated over water shall determine the risks to survival of the occupants of the balloon in the event of a ditching, based on which he/she shall determine the carriage of an emergency locator transmitter (ELT) capable of transmitting simultaneously on 121,5 MHz and 406 MHz.

SPO.SPEC.PAR.125 Releasing of dangerous goods

Notwithstanding SPO.GEN.155, parachutists may exit the aircraft for the purpose of parachute display over congested areas of cities, towns or settlements or over an open-air assembly of persons whilst carrying smoke train devices, provided these are manufactured for this purpose.

SECTION 4
Aerobatic flights (ABF)**SPO.SPEC.ABF.100 Standard operating procedures**

The standard operating procedures for ABF shall specify:

- (a) the equipment to be carried, including its operating limitations and appropriate entries in the MEL, as applicable;
- (b) crew composition and experience requirements of crew members and task specialists;
- (c) the relevant training for crew members and task specialists to perform their task and the qualification and nomination of persons providing such training to the crew members and task specialists;
- (d) responsibilities and duties of crew members and task specialists;
- (e) performance criteria necessary to be met to conduct aerobatic flights;
- (f) normal, abnormal and emergency procedures.

SPO.SPEC.ABF.105 Documents, manuals and information to be carried

The following documents listed in SPO.GEN.140(a) need not be carried during aerobatic flights:

- (a) details of the filed ATS flight plan, if applicable;
- (b) current and suitable aeronautical charts for the route/area of the proposed flight and all routes along which it is reasonable to expect that the flight may be diverted;
- (c) procedures and visual signals information for use by intercepting and intercepted aircraft; and
- (d) information concerning search and rescue services for the area of the intended flight.

SPO.SPEC.ABF.115 Equipment

The following equipment requirements need not be applicable to aerobatic flights:

- (a) first-aids kit as laid down in SPO.IDE.A.165 and SPO.IDE.H.165;
- (b) hand-fire extinguishers as laid down in SPO.IDE.A.180 and SPO.IDE.H.180; and
- (c) emergency locator transmitters or personal locator beacons as laid down in SPO.IDE.A.190 and SPO.IDE.H.190.